

OWNER'S MANUAL

TORRES



<https://www.automotive-manuals.net/>

Recommended Fluids and Lubricants

Descriptions		Capacity	Specifications
Engine Oil	G15DTF	≈ 4.5 ℓ	Quality class: KG Mobility genuine engine oil or Approved by ACEA C2 SAE 0W/30
Engine Coolant	G15DTF	≈ 7.0 ℓ	KG Mobility genuine coolant Anti-Freeze: SYC-1025 Anti-Freeze:Water = 50:50 ORGANIC ACID TYPE, COLOR:BLUE
Automatic Transaxle Fluid	G15DTF	≈ 6.2 ℓ	KG Mobility genuine oil (AW-1)
Manual Transaxle Fluid	G15DTF	≈ 1.95 ℓ	KG Mobility genuine oil (SK ZIC SYN MTF 70W)
Transfer Case (PTU) Fluid	G15DTF A/T	≈ 0.6 ℓ	KG Mobility genuine oil (SAE 80W/90, API GL-5)
Rear Axle Oil	AWD	≈ 0.6 ℓ	KG Mobility genuine oil (SAE 80W/90, API GL-5)
Brake / Clutch Fluid		As required	KG Mobility genuine oil (DOT4)



Warning

- Use only KG Mobility recommended fluids and lubricants.
- Do not mix any different types or brands of oils or fluids. This may cause damages.
- Keep the specified levels when adding or replacing the fluids.

Notice

- The antifreeze mixture ratio at the time of vehicle delivery is 45%.

Foreword

This section provides useful information to know in advance for reading the owner's manual.

Information regarding the marks used in the owner's manual, change of car design, and periodic check is provided.

Thank you for purchasing the TORRES.

TORRES you selected is a vehicle with superior safety and quality and the latest technologies. KG Mobility Corporation has been carrying out and initiating R&D activities continuously in the industry.

Please read this owner's manual carefully before driving the TORRES. You can drive safely and economically by utilizing the technical advantages applied to the vehicle.

We will dedicate ourselves to ensure that you can always drive the TORRES pleasantly and safely.



Purpose and Application Conditions of the Owner's manual

This owner's manual has been prepared to provide information for the specifications and functions of the vehicle, and important safety information including cautions and warnings for safe driving and correct vehicle maintenance.

- All descriptions, pictures, and drawings included in this owner's manual are based on the time of the document's preparation. If there is a change in the specifications (options) and functions according to a change of design, some content may be different from the actual vehicle.
- This owner's manual has been prepared based on all specifications (options) of the vehicle. Please understand that an explanation of a specification (options) which is not provided for your vehicle may be provided.

As some options or option packages may be added or deleted randomly depending on the vehicle point of sale and design changes, make sure that the options you applied when signing the contract are fitted to your vehicle prior to reading this owner's manual.

Please read this owner's manual carefully before driving the vehicle, to ensure safe driving and the best vehicle performance.

Open Source Software Notice Information

To obtain the source code under GPL, LGPL, MPL, and other open source licenses, that is contained in this product, please visit <http://opensource.lge.com>.

In addition to the source code, all referred license terms, warranty disclaimers and copyright notices are available for download.

LG Electronics will also provide open source code to you on CD-ROM for a charge covering the cost of performing such distribution (such as the cost of media, shipping, and handling) upon email request to opensource@lge.com.

This offer is valid for a period of three years after our last shipment of this product. This offer is valid to anyone in receipt of this information.

Marks Used in this Owner's manual



It indicates a dangerous situation (DANGER) that may likely to lead to death or serious injury.

It should be observed for the safety of the driver and other passengers.



It indicates a dangerous situation (WARNING) that may lead to death or serious injury.

It should be observed for the safety of the driver and other passengers.

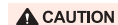

It indicates a dangerous situation (CAUTION) that may lead to moderate or minor injury, or a situation that may lead to damage to the vehicle.

It should be observed for the safety of the driver and other passengers and the prevention of property damage.



It is used for explaining additional information or procedures related to the vehicle and driving.



It is used to indicate the location of relevant information useful for using the product.

Change of Specifications (options) and Functions According to a Change of Design

The design is subject to change without prior notice for improving the safety and performance of the vehicle. Therefore, a vehicle specification (options) may be added or deleted, or a function may change.

The content explained in this owner's manual may be different from your vehicle.

Do Not Use Vehicle Components for Other Purposes

Do not use vehicle components for other purposes. KG Mobility Corporation is not liable for any consequent damages.

Importance of a Periodic Check

Have your vehicle checked and maintained at a prescribed period in order to maintain the performance of the vehicle and to prevent the reduction of its life.

Information for Using KG Mobility Authorized Service Center

KG Mobility Corporation is not liable for any problem that occurred due to maintenance carried out by a service center other than KG Mobility Authorized Service Center.

Table of Contents

The table of contents is provided in three types to allow you to find necessary information in a convenient method easily and fast.

- Introduction to chapters - You can identify the content of each chapter at a glance.
- Detailed table of contents - You can find desired information using a name through the detailed title for the relevant chapter.
- Table of pictures - You can find desired information using a picture easily even if you do not know the title of the desired information.

Introduction to Chapters

Identify the contents of each chapter at a glance.

Foreword

- You can check information regarding the marks used in the instruction manual, change of car design, and periodic check.

1. Vehicle Information and Safety Precautions

- You can check helpful information for driving and managing the vehicle safely and conveniently.
- Information regarding the vehicle identification, specifications, check points before driving the vehicle, safety precautions while driving, and vehicle maintenance methods is provided.

2. Safety Units

- You can check information regarding devices that allow you to drive the vehicle safely and how to use such devices.
- An explanation is provided for seat belts, a baby car seat, airbags, anti-theft, and warning system.

3. Convenient Equipment

- You can check information regarding devices that allow you to drive the vehicle conveniently and usefully and how to use such devices.
- An explanation is provided for doors, seats, windows, as well as various convenient equipment including the tailgate, various lights and lamps, mirrors, heater and A/C, AV navigation, storage and cargo box.

4. Starting and driving

- You can check information regarding the basic auxiliaries for safe driving, auxiliary equipment that helps you to drive comfortably, and how to use such equipment.
- An explanation is provided for the START/STOP switch and smart key as well as the driving system including the instrument cluster, gear shift lever, 4WD, cruise control, auxiliary driving system such as the brake and autonomous emergency braking system, rear and side warning lane departure warning system, and parking assistance system.

5. Emergency Measures in the Event of Emergency

- You can check useful information and emergency measures for various emergency situations you can face while driving.
- Information regarding the warning triangle and OVM tools, and a correct measure in case of a dead battery, engine overheating, flat tire, and towing a vehicle is provided. An explanation is also provided for how to respond to a fire, heavy snow, vehicle trouble, and an accident safely.

6. Periodic Checking and Maintenance

- You can check the necessary periodic check and maintenance methods in detail for safe and pleasant vehicle driving.

Index

- You can find important functions or terms from the content of this instruction manual in alphabetical order conveniently.

Detailed Table of Contents

Find the desired information using a name through detailed titles.

1. Vehicle Information and Safety Precautions

Information regarding the installation of ADR and provision of information	1-2
Precautions for potentially hazardous seat belt related goods.....	1-3
Precautions for the reduction of non-crash incidents	1-4
Cautions for the protection of the environment.....	1-5
Certification	1-6
Vehicle identification.....	1-9
Certification label	1-9
Vehicle Identification Number (VIN)....	1-9
Vin Label*.....	1-9
Engine number	1-9
Dimensions.....	1-10
Specifications	1-11

Precautions for the modification of the vehicle and structural alteration	1-14
Checking before driving	1-16
Daily inspection	1-16
Checking engine room	1-16
Checking engine coolant	1-16
Checking engine oil	1-16
Checking brake fluid (clutch fluid) ..	1-17
Checking washer fluid	1-17
Checking belts.....	1-17
Checking tires	1-17
Checking the instrument cluster	1-18
Checking the parking brake	1-18
Checking the pedals	1-19
Cleaning up near the driver's seat.....	1-19
Advisable driving position.....	1-19
Adjusting the seat, headrest, steering wheel, and mirrors.....	1-19
Wearing the seat belt correctly	1-20
Safety and cautions for driving.....	1-21

No drugged, drunk, distracted and drowsy (4D) driving.....	1-21
Cautions for air bag	1-21
Precautions for infants, children, old people, or pregnant women	1-22
An infant or a small child must be seated in the rear seat with protective gear	1-22
No sleeping in a sealed vehicle	1-22
Do not drive with the doors or tailgate open.....	1-23
Do not hold a part of your body out of the window or sunroof	1-23
Be careful not to have a part of your body caught when using the power window	1-23
Check for any vehicles or persons passing by when getting out	1-24
Safe parking and stopping.....	1-24
Warming up the engine correctly	1-24
Do not stop the engine while driving.....	1-25
No sudden starting, acceleration or braking.....	1-25

Driving on unpaved and mountain roads	1-25
In high mountain area	1-25
Driving on a snowy or icy road	1-25
Driving on a sandy or muddy road	1-25
Driving on a hillside road and downhill road	1-26
Driving on a road with a pool of water or a river.....	1-26
Do not use a cellular phone or watch DMB while driving	1-26
Driving on the expressway	1-27
Crossing an intersection or railroad crossing	1-27
No sudden maneuvering of the steering wheel	1-27
Do not warm up the engine or check the vehicle in a sealed space.....	1-27
Use of the engine brake.....	1-27
Cautions for attaching accessories....	1-28
Special cautions when checking the coolant.....	1-28
Do not load hazardous materials	1-28
Cautions for vehicle ventilation.....	1-28

System protection function (delayed accelerator pedal response)	1-28
---	------

Placement of extinguisher	1-28
---------------------------------	------

Vehicle management..... 1-29

KG Mobility Authorized Service Center and maintenance partners.....	1-29
---	------

Cautions for the depletion of battery when connecting uninterruptible power supply to the black box system.....	1-29
---	------

Long-term parking mode.....	1-29
-----------------------------	------

Breaking in a new vehicle correctly ...	1-29
---	------

Using genuine parts.....	1-29
--------------------------	------

Vehicle washing	1-30
-----------------------	------

Washing the bumper	1-31
--------------------------	------

Washing wheels.....	1-31
---------------------	------

Cautions for polishing the vehicle	1-31
--	------

Cleaning and maintaining glass.....	1-32
-------------------------------------	------

Cautions for window tinting.....	1-32
----------------------------------	------

Care and cleaning of the interior.....	1-32
--	------

Seat Belt Care.....	1-33
---------------------	------

Cautions for using the vehicle key.....	1-33
---	------

Corrosion protection	1-33
----------------------------	------

Sheet Metal Damage	1-33
--------------------------	------

Foreign Material Deposits	1-33
---------------------------------	------

Finish Damage	1-34
---------------------	------

Underbody Maintenance.....	1-34
----------------------------	------

System safety mode	1-35
--------------------------	------

Vehicle Fueling from Drums or Storage Containers	1-35
--	------

Fuel recommendation	1-35
---------------------------	------

Gasoline Engine	1-35
-----------------------	------

Fuel Recommendation	1-35
---------------------------	------

Do not Use Methanol	1-36
---------------------------	------

Engine check indicator	1-36
------------------------------	------

Other maintenance.....	1-36
------------------------	------

2. Safety Units

Seat belt 2-2

Seat belt warning	2-2
-------------------------	-----

Front seat (driver / passenger) belt reminder	2-3
---	-----

Front seat (passenger) belt reminder	2-3
--	-----

Rear seat (left / center / right) belt reminder*	2-3
--	-----

Fastening the seat belt	2-4
-------------------------------	-----

Unfastening the seat belt	2-5
---------------------------------	-----

Managing the seat belt	2-5	Table of Vehicle Handbook Information on ISOFIX Child Restraint Systems Installation Suitability for Various ISOFIX Positions	2-13	Warning For Child Restraint	2-19
Adjusting the height of the front seat belt	2-5	Table of Vehicle Handbook Information for Installation in Various Seating Positions on i-Size Child Restraint Systems	2-14	Air bag*	2-20
Rear seat belt storage	2-6	List of suitable universal Child Restraint Systems (CRS)	2-14	Air bag warning label	2-20
Rear seat buckle storage	2-6	List of suitable ISOFIX Child Restraint Systems (CRS)	2-14	Air bag warning lamp	2-20
Rear center seat belt storage	2-6	List of suitable i-Size Child Restraint Systems (CRS)	2-14	Air bag crash sensor and air bag control module	2-21
Rear center seat belt release	2-6	Installation of crs secured by the seatbelt	2-15	Configuration of air bag	2-21
How to fasten the seat belts (2-point) in rear center seat	2-7	Front-facing Child Seat	2-15	Passenger Air Bag ON/OFF Switch*	2-21
How to fasten the seat belt (3-point) in rear center seat	2-7	Rear-facing Child Seat	2-15	Driver air bag	2-22
Seat belt pretensioner and load limiter	2-8			Driver knee air bag	2-22
Pretensioner	2-8			Front passenger air bag	2-22
Load limiter	2-9			Front seat side air bag	2-23
Fastening the seat belt by a pregnant woman	2-9			Far side air bag	2-23
Warnings for the seat belt	2-9			Curtain air bag	2-23
Child restraint for an infant or a small child	2-11	Securing a child restraint system with “ISOFIX/i-Size” system and “Tether Anchorage” system*	2-17	Cases where the air bag does not inflate	2-24
Infant and child safety	2-12	Locations of ISOFIX/i-Size Lower Anchors and Top Tether	2-17	In the event of a slight collision	2-24
Child Seat	2-12	How to use ISOFIX/i-Size Lower Anchor	2-17	In the event of a rear end collision	2-24
Table of Vehicle Handbook Information on Child Restraint Systems Installation Suitability for Various Seating Positions	2-12	How to use Top Tether	2-18	In the event of a side collision	2-25

In case the vehicle moves beneath another vehicle	2-26
In the event of a rollover accident ..	2-26
Secondary injury due to air bag deployment	2-26
Other cases	2-27
Warnings for the air bag	2-27

Tire pressure monitoring system (TPMS)*

Checking the tire pressure	2-29
If the tire pressure or the TPMS is abnormal	2-30
Display of the TPMS status on the instrument cluster	2-31
When low tire pressure is detected ...	2-33
When you have rotated the tires	2-33
Cautions for the TPMS	2-34

Anti-theft and warning system

Immobilizer system*	2-35
Immobilizer/smart key warning light	2-35
If the engine does not start	2-36
When the transponder is damaged	2-36

When you lose the key	2-36
Theft deterrent system	2-37
Entering the theft monitoring mode	2-37
Activating the theft alarm	2-38
Holding the theft alarm	2-38
Canceling the theft monitoring mode	2-38

3. Convenient Equipment

Door

How To Lock/Unlock & Open Door	3-2
Door Opening Lever	3-2
How To Check If Door Locked/Unlocked	3-2
Door Lock/Unlock button	3-2
Auto door lock function at the time of driving	3-3
Auto door unlock function at the time of collision	3-3
How To Lock Doors In Emergency	3-4
To lock doors with mechanical key (excluding driver door)	3-4
Child safety door lock	3-5

Locking/unlocking the door lock	3-5
---------------------------------------	-----

Seat

Seat & adjustment switch / button / lever	3-6
Front seat	3-7
Adjusting the headrest	3-7
Adjusting the front and rear angles ..	3-7
Adjusting the height	3-7
Separation/installation	3-7
Adjusting the power seat*	3-8
Front and rear position adjustment (driver seat/front passenger seat) ...	3-8
Adjusting the height (driver seat/front passenger seat)	3-8
Adjusting the cushion angle (driver seat/front passenger seat)	3-9
Adjusting the backrest angle (driver seat/front passenger seat)	3-9
Adjusting the lumbar support (driver seat)	3-9
Adjusting the seat manually	3-10
Front and rear position adjustment (driver seat/front passenger seat)	3-10
Adjusting the backrest angle (driver seat/front passenger seat)	3-11
Adjusting the height (driver seat) ..	3-11

Rear seat	3-11	Sunroof*	3-21	Open/Close Tailgate With Interior Switch	3-26
Adjusting the height of the headrest.....	3-11	Opening the sunroof	3-22	Opening/closing with the smart key.....	3-27
Seatback reclining adjustment	3-12	Opening automatically.....	3-22	Opening/closing with the button on the tailgate.....	3-27
Rear seat backrest folding	3-13	Opening manually	3-22	Anti-pinch protection function.....	3-28
Seat Ventilation & Heating.....	3-14	Closing the sunroof.....	3-22	Resetting the opening height	3-28
Front seat ventilation and heating*	3-14	Closing automatically	3-22	Resetting the power tailgate	3-28
Front seat ventilation.....	3-14	Closing manually	3-22	Smart tailgate*.....	3-29
Front seat heating*	3-15	Tilting the sunroof up/down	3-23	Activating/deactivating the smart tailgate.....	3-29
Smart front seat heating control....	3-15	Tilting up (opening the rear section).....	3-23	Opening the smart tailgate	3-30
Rear seat heating*	3-16	Tilting down (closing the rear section).....	3-23	Operating condition.....	3-30
Rear seat heating smart control....	3-16	Sunroof open warning	3-23	Operation step	3-30
Warnings and cautions related to the seats	3-17	Sunroof safety function.....	3-23	Stopping the smart tailgate function.....	3-30
Window (power window)*	3-18	Resetting the sunroof	3-24	Opening the tailgate in the event of emergency.....	3-31
Opening the driver seat/front passenger seat window	3-18	Cases requiring the resetting of the sunroof	3-24	Engine hood	3-33
Closing the driver seat/front passenger seat window	3-18	Resetting.....	3-24	Opening the engine hood.....	3-33
Driver seat window safety function.....	3-19	Tailgate	3-25	Closing the engine hood	3-33
Opening/closing the rear seat window	3-19	Manual tailgate	3-25	Checking before closing the engine hood	3-33
Rear seat window lock function	3-20	Opening	3-25	Closing the engine hood	3-33
		Closing	3-25		
		Power tailgate*	3-26		

Fuel inlet	3-34	In case the DRL turns on	3-40	Linkage function between the smart/reakes key and the front room lamp	3-47
Opening the fuel inlet	3-34	In case the DRL turns off.....	3-41	Center room lamp	3-48
Closing the fuel inlet	3-35	Smart High Beam (SHB)*	3-41	Luggage room lamp.....	3-48
Lights and lamps	3-36	Setting the SHB	3-41	Sun visor/mirror lamp.....	3-48
Outdoor lights/lamps	3-36	In case the high beam turns on	3-42	Glove box lamp	3-49
Light switch.....	3-37	In case the high beam turns off	3-42	Mood lamp*	3-49
Turning on the head light	3-37	Operating the Light switch	3-42	Mood lamp setting	3-49
Turning on the tail light	3-37	AUTO Approach	3-43	e-call (Emergency call)*.....	3-50
Activating the auto light function* ..	3-37	In case the auto approach lamp turns off.....	3-43	How to use E-CALL system	3-50
Turning off all lights.....	3-37	Coming home/living home light	3-44	e-call can't be canceled when	3-52
Turning on the front fog light*	3-37	Setting the coming home/living home light.....	3-44	Wiper and washer fluid.....	3-54
Turning on the rear fog light*	3-37	Operating the coming home light ..	3-44	Windshield wiper.....	3-54
Turning off the fog light*	3-37	Operating the living home light	3-44	Adjusting the operation speed of the windshield wiper	3-54
Turning on/off the left/right turn signal.....	3-37	Auto light function*	3-45	Front windshield and washer fluid linkage.....	3-54
Turning on/off the high beam	3-38	Auto light sensor	3-45	Front auto washer	3-54
Turning on the high beam and low beam at the same time (passing light)	3-38	Interior lamp.....	3-46	Rear window wiper	3-55
Hazard warning lamp	3-38	Front room lamp (overhead console).....	3-47	Rear window wiper washer fluid linkage function	3-55
Adjusting the angle of the head light.....	3-39	Driver seat spot switch	3-47	Rain sensing wiper*	3-55
Angle adjustment levels of the head light.....	3-39	Front passenger seat spot switch	3-47	Rain sensor	3-55
Angle adjustment standard for the head light.....	3-40	Driver / passenger / center room lamp spot switch	3-47	Mirror	3-56
Daytime Running Light (DRL)*	3-40	Door linkage switch.....	3-47		
		Front spot lamp.....	3-47		

Outside rearview mirror	3-56	Driver/Passenger Side Temperature Control.....	3-63	Buttonless Integrated Control Panel Screen Off	3-71
Folding/unfolding the outside rearview mirror	3-56	Independent Temperature Control (SYNC Off)	3-63	Vehicle settings switch	3-71
Auto folding/unfolding function	3-56	Temperature Synchronization Control (SYNC On)	3-64	Buttonless Integrated Control Panel Favorites	3-72
Adjusting the outside rearview mirror	3-56	AUTO Mode.....	3-64	How to set Favorites menu.....	3-72
Selecting the outside rearview mirror.....	3-56	Manual Mode	3-65	Buttonless Integrated Control Panel Reset.....	3-72
Adjusting the angle of the outside rearview mirror.....	3-57	Air Distribution.....	3-66	How To Reset.....	3-72
Interior mirror	3-57	Activating glass heater	3-66	Steering wheel	3-73
ECM room mirror*	3-57	How to Dehumidify Window Glass.....	3-67	Adjusting the height/length of the steering wheel	3-73
Manual type inside rearview mirror....	3-58	Auto Defogger System (ADS)	3-68	Steering wheel heater*	3-73
Manual Day/Night Adjustment.....	3-58	Operation levels of auto defogger system	3-68	Horn	3-74
Heater and air conditioner	3-59	Eco Mode.....	3-68	Infotainment system	3-75
Adjusting the direction of air distribution and blocking the air distribution.....	3-59	Activating glass heater.....	3-69	Smart audio*	3-75
Rear air distribution and fan speed control	3-60	Switch Between Buttonless Integrated Control Panel Screens	3-69	AV/Navigation.....	3-76
Cautions for using the heater and air conditioner.....	3-60	Buttonless Integrated Control Panel Screen Composition	3-70	Slots for multimedia	3-76
Replacing A/C refrigerant/oil.....	3-60	Items to be displayed at all times...	3-70	Operating from the steering wheel	3-77
Heater & A/C Controls.....	3-62	Heater and A/C control (FATC) screen	3-70	Bluetooth hands-free	3-77
Turning Heater and A/C On/Off	3-63	Front seat heating / ventilation control screen	3-70	Mute.....	3-77
				Controlling the volume	3-77
				Searching for media (SEEK).....	3-77
				Selecting the mode.....	3-78

Voice recognition function	3-78
Antenna	3-78
USB charging port	3-79
Power socket	3-80
Indoor convenient equipment ..	3-81
Sun visor and card holder (driver seat)	3-81
Sun visor	3-81
Card holder	3-81
Mirror and lamp	3-81
Grip handle/coat hanger	3-82
Rear seat door roller blind*	3-82
Storage unit	3-83
Front seat/rear seat cup holder*	3-83
Front storage (W/O WPC)	3-83
Front side storage box	3-84
Rear storage box	3-84
Glove box	3-84
Console	3-85
Door map pocket	3-85
Seat backrest pocket	3-86
Wireless Phone Charger System*	3-86

To Charge Phone	3-86
Additional equipment in the luggage compartment*	3-89
Luggage upper cover	3-89
Installing the luggage upper cover ..	3-89
How to store luggage upper cover ..	3-89
Luggage compartment	3-90
Roof rack*	3-91

4. Starting and driving

START/STOP switch (Smart key)* 4-2	
OFF status	4-2
ACC status	4-2
ON status	4-2
READY status	4-2
Starting the engine	4-3
Starting the engine	4-3
Restarting the engine when it cannot be started	4-3
Stopping the engine	4-4
Stopping the engine while driving (in the event of emergency)	4-4

System safety mode	4-4
Cautions for using the START/STOP switch	4-5
Key cylinder (ignition key)	4-6
OFF position (LOCK)	4-6
ACC position	4-6
ON position	4-6
START position	4-6
Starting the engine	4-7
Starting the engine	4-7
Restarting the engine when it cannot be started	4-7
Stopping the engine	4-8
System safety mode	4-8
Smart key* & REKES key	4-10
Function of each button	4-10
Locking the door	4-10
Unlocking the door (when the safety unlock is enabled)	4-11
Unlocking the door (when the safety unlock is disabled)	4-12
Opening/closing the tailgate (A type)	4-12

Activating/deactivating the panic mode (B type)	4-12	Replacing the smart key/rekes key battery	4-19	Electric power steering warning light.....	4-27
Additional functions	4-13	Instrument cluster	4-21	Parking brake ON indicator (red) ...	4-27
Smart door auto lock (auto close) ..	4-13	Driving Information Display.....	4-22	ABS (Anti-Lock Brake System) warning light	4-28
Activating the smart door auto lock function (Activating from the instrument cluster).....	4-13	Engine RPM	4-22	Brake warning lamp.....	4-28
Activating the smart door auto lock function (Activating with the smart key).....	4-13	Driving Speed	4-22	Electronic Parking Brake (EPB) warning light	4-29
Locking/unlocking the door with the door handle switch	4-14	Over speed warning light (GCC only).....	4-22	AUTO HOLD indicator/warning light.....	4-29
To lock with door handle switch ...	4-14	Engine Coolant Temperature	4-22	Engine check indicator	4-29
To unlock with door handle switch (when the safety unlock is disabled)....	4-14	Fuel gauge	4-23	Steering wheel heater indicator*....	4-30
To unlock with door handle switch (when the safety unlock is enabled).....	4-15	Total mileage.....	4-23	Electronic stability control system (ESC) ON indicator/warning light ...	4-30
Cautions for using smart key / REKES key.....	4-16	Position of gear shift lever.....	4-24	Electronic stability control system (ESC) OFF indicator	4-30
Using the emergency key.....	4-17	Gear position display in D (automatic) mode	4-24	Low fuel level warning light	4-31
Unfolding/folding the emergency key.....	4-17	Gear shift point indicator in manual mode.....	4-24	Global warning light	4-31
Locking/unlocking the door using the emergency key.....	4-17	Manual transmission display.....	4-24	Autonomous Emergency Braking (AEB) warning light.....	4-31
Starting the engine with the dead smart key or interference, etc. (in the event of emergency)	4-19	Warning lights and indicators	4-25	Autonomous Emergency Braking (AEB) OFF indicator	4-32
		Seat belt warning lamp.....	4-25	Hill Descent Control (HDC) ON indicator/warning light	4-32
		Air bag warning lamp	4-25	LKA (LDW) indicator / warning lamp*.....	4-32
		Engine oil pressure warning light...	4-25		
		Charge warning light.....	4-26		
		Immobilizer/smart key warning light.....	4-26		
		Engine overheat warning lamp.....	4-26		

Centering lane keeping assist (CLKA) indicator / warning lamp.....	4-33	Mileage/average speed/driving time.....	4-40	Gear selector lever in automatic transmission*.....	4-95
Illumination ON indicator.....	4-33	Driving information after departure.....	4-41	Paddle shift (-/+).....	4-95
Front fog lamp ON indicator*.....	4-33	ISG cumulative time.....	4-41	Shift Lock.....	4-96
Rear fog lamp ON indicator*.....	4-33	Media Display.....	4-41	Operation procedures for shift lock....	4-96
SHB indicator*.....	4-33	TPMS status.....	4-42	P (parking) position.....	4-97
High beam indicator.....	4-34	Driving assist Menu.....	4-42	R (reverse) position.....	4-97
Turn signal/hazard warning lamp...	4-34	Driving assist.....	4-42	N (neutral) position.....	4-97
WINTER / SPORT indicator lamp ..	4-35	Driver attention alert.....	4-42	D (driving) position.....	4-98
Hands OFF warning lamp*.....	4-35	User settings.....	4-43	+/- (manual) position.....	4-99
ISG indicator/warning lamp*.....	4-35	Message on the display of the instrument cluster.....	4-48	Shifting.....	4-99
ISG OFF indicator*.....	4-36			Using the engine brake.....	4-101
4WD CHECK warning lamp*.....	4-36			If the gear shift lever cannot be moved from the P (parking) position to another position.....	4-101
4WD LOCK ON indicator*.....	4-36				
Over speed warning light (GCC only).....	4-37	Instrument cluster illumination brightness.....	4-91		
Door open warning light.....	4-37	To Adjust Instrument Cluster Illumination Brightness.....	4-91		
Master symbol.....	4-37			Driving a vehicle equipped with automatic transmission.....	4-102
Indicator panel on instrument cluster.....	4-38	Shift lever in manual transmission.....	4-92	Using the engine brake.....	4-103
Main menu.....	4-38	Downshifting.....	4-93	Using the kick down function.....	4-104
Main menu list.....	4-39	Gear position when parking.....	4-93	Safety mode of the automatic transmission.....	4-104
Trip computer information.....	4-39	Using the clutch.....	4-93	Resetting the safety mode when the gear shift lever is fixed to a position.....	4-104
Distance to empty/average fuel economy/Instantaneous fuel economy.....	4-39	Driving tips for normal starting off or starting off on uphill.....	4-93		
		EPB operation when driving uphill.....	4-94		

Cautions for using a vehicle equipped with automatic transmission.....	4-105	Cruise Control Ready / Enabled Display.....	4-113	Temporary acceleration (override)...	4-120
4WD System*	4-106	Setting the cruise control driving speed	4-113	Deactivating.....	4-121
4WD LOCK Shift.....	4-106	Speed acceleration process of the cruise control.....	4-114	Disable conditions	4-121
Driving Modes and Indicators.....	4-106	Speed deceleration of the cruise control	4-115	Other disable conditions	4-121
4WD LOCK indicator (green)	4-106	Deactivating the cruise control	4-116	Resume	4-122
4WD CHECK warning lamp (red)	4-106	Deactivation condition	4-116	To Deactivate	4-122
Driving Modes	4-107	Other deactivation conditions according to the vehicle condition	4-116	Steering wheel (steering force) control alert.....	4-123
Cautions for using 4WD system	4-107	Resuming the cruise control	4-117	To set safety distance to front vehicle	4-125
ISG (Idle Stop & Go) System* ..	4-109	Intelligent / Adaptive Cruise Control*.....	4-118	Forward situation awareness	4-126
Engine Automatic Shutdown.....	4-109	Intelligent Cruise Control Ready / Enabled Display.....	4-118	Starting at congested areas.....	4-126
Automatic Engine Restart	4-109	Set intelligent cruise (enabled)....	4-118	Front detection sensor (Front radar + front camera)	4-126
ISG system OFF	4-110	Intelligent Cruise Control Ready..	4-118	Vehicle detection is difficult under the following circumstances:.....	4-127
Conditions for ISG system activation.....	4-110	To enable intelligent cruise control at instrument cluster.....	4-119	Not detected preceding pedestrian	4-128
Forced restart conditions	4-110	To set intelligent cruise control	4-119	Curved road.....	4-128
Battery sensor (BSC).....	4-111	Increasing speed.....	4-120	Uphill or downhill.....	4-129
Conditions for activating battery sensor (BSC)	4-111	Decreasing speed	4-120	To change lane	4-129
Cruise control system	4-112			Detecting vehicle ahead	4-130
Conditions for using the cruise control	4-112			Speed Limit*	4-131
Cruise control switch and indicator..	4-112			Images that show readiness and operation	4-131
Cruise control switch.....	4-112				

Speed limit ready	4-131	ESC indicator/warning light	4-139	AUTO HOLD indicator/warning light.....	4-147
To set speed limit	4-131	ESC OFF indicator	4-139	Autonomous Emergency Braking (AEB)*	4-148
How to enable speed limit in instrument cluster.....	4-132	Phenomenon that occurs when the ESC is activated	4-140	AEB indicator/warning light.....	4-148
To Turn Speed limit ON/OFF.....	4-132	When it is necessary to deactivate the ESC function.....	4-140	AEB OFF indicator	4-148
To set speed	4-132	Hill Descent Control (HDC).....	4-141	AEB indicator/warning light	4-148
To deactivate speed limit warning ...	4-132	Activating/deactivating the HDC function.....	4-141	AEB is activated.....	4-149
Brake system	4-134	HDC indicator/warning light.....	4-142	Setting the sensitivity of the forward collision warning	4-149
Foot brake	4-135	HDC activation conditions.....	4-142	AEBS operation	4-150
Checking for foreign materials on the pedal operation area.....	4-135	HDC deactivation conditions.....	4-142	Activation conditions.....	4-151
Checking and replacing the brake pads/discs	4-136	HDC operation	4-142	Deactivation conditions	4-151
If the brake is not working	4-136	Electronic Parking Brake (EPB).....	4-143	The AEB cannot detect a vehicle properly:.....	4-151
ABS (Anti-Lock Brake System).....	4-136	Applying the EPB.....	4-143	The AEB cannot detect a pedestrian	4-154
ABS warning light.....	4-137	Releasing the EPB	4-143	Rear and side warning system*	4-156
Electronic Brake-Force Distribution (EBD)	4-137	Releasing the EPB automatically.....	4-144	Display of rear and side warning system activation	4-156
Brake warning lamp.....	4-137	EPB warning light/brake warning light.....	4-144	Warning Steps in BSW System ...	4-157
Emergency Stop Signal (ESS)	4-138	EPB emergency mode	4-144	When the rear and side warning system is abnormal	4-157
Activation and deactivation conditions.....	4-138	AUTO HOLD	4-146		
Electronic stability control system (ESC)	4-139	To Set / Deactivate AUTO HOLD Function.....	4-146		
		Using the AUTO HOLD function ..	4-146		

Blind Spot Detection Warning (BSW) system	4-158
Activating / deactivating BSW system	4-158
Activation conditions	4-158
Lane Change Warning (LCW) system	4-159
Operating conditions	4-159
BSA System	4-159
Activating / deactivating BSA system	4-159
Operating conditions	4-160
BSA is deactivated when:	4-160
RCTW System	4-160
Activating / deactivating RCTW system	4-161
Activation conditions	4-161
RCTA System	4-162
Activating / deactivating RCTA system	4-162
Operating conditions:	4-162
Cases where RCTA system not work	4-163
Cases where the RCTA system malfunctions	4-163

SEW System	4-164
Activating / deactivating SEW system	4-164

LDW (Lane Departure Warning)* **4-165**

To activate / deactivate lane departure warning (LDW)	4-165
LDW ON indicator	4-166
Activation conditions	4-166

Cases that the system is not activated

Cases requiring the driver's attention

LKA (Lane Keeping Assistance)* **4-169**

To activate / deactivate lane keeping assistance (LKA)	4-169
LKA ON indicator	4-170
Operating conditions	4-170

Cases that the system is not activated

Cases requiring the driver's attention

ELK (Emergency Lane Keeping)* **4-173**

RKA-ROADEDGE (Lane Keeping Assist-Roadedge)	4-173
Activation / Deactivation	4-173
Operating conditions	4-173
Does not work when:	4-174
Driver Attention Required	4-175

Centering Lane Keeping Assist (CLKA) **4-176**

To activate / deactivate CLKA	4-176
Centering lane keeping assist (CLKA) ON indicator lamp	4-177
Conditions for activation	4-177
The CLKA does not work when:	4-178

 Driver Attention Required

FVSW (Front Vehicle Start Warning)* **4-181**

How To Set	4-181
Operation	4-181

Parking assist system* **4-182**

Front/rear obstacle detection system	4-182
Activating the obstacle detection system	4-183

Warning buzzer interval	4-184
Sensor and relevant system malfunction	4-184
If the system does not operate or malfunctions	4-185
Cautions regarding the front/rear obstacle detection system.....	4-186
Rear camera system.....	4-186
Double parking (2-row parking)	4-188
Vehicles With EPB.....	4-188

5. Emergency Measures in the Event of Emergency

Warning triangle and OVM (Owner Vehicle Maintenance) tools	5-2
Warning triangle.....	5-2
Storage place of the warning triangle*	5-2
OVM tools	5-2
Location where the OVM tools are stored	5-3

When the engine cannot be started due to depletion of the battery..... 5-4

Starting the engine using the jump cable	5-4
--	-----

When the engine is overheated or other problems have occurred ... 5-6

When the engine is overheated so that the warning light turns on	5-6
Symptoms that appear when the engine is overheated	5-6
Emergency measures when the engine is overheated	5-6
When the engine check indicator turns on	5-7

When a tire is flat..... 5-8

Repairing a flat tire/inflating a tire using the service kit for tire repair	5-9
Components of the service kit for tire repair*	5-9
Storage location of the service kit ...	5-9
Confirming whether it is possible to repair the flat tire with the service kit or not.....	5-9
Operating principle of the service kit	5-10

Repairing a flat tire	5-10
Inflating a tire	5-15
Removing the spare tire (Temporary)*	5-16
Changing a spare tire (Temporary)....	5-17
When replacing a front tire	5-17
When replacing a rear tire.....	5-18
Cautions when changing the tire.....	5-20

When you need to have your vehicle towed..... 5-21

Towing a disabled vehicle	5-21
Towing with tow truck	5-21
For 4WD vehicle	5-21
For 2WD vehicles.....	5-21
When a tow truck is unavailable (in case of emergency)	5-22
Installing the towing hook.....	5-22
Using a towing rope.....	5-23
Trailer towing.....	5-24
Trailer loading	5-24
Maximum Load Limits	5-24
If you want to pull a trailer	5-25
Weight of trailer	5-25
Weight of trailer tongue	5-25

Trailer brakes	5-26
Trailer lights	5-26
Tires.....	5-26
Safety chains	5-26
Brake fluid	5-26
Automatic transmission fluid	5-26
Towing tips	5-26
Driving on hill	5-27
Parking on hills	5-27
When you are ready to leave after parking on a hill	5-27
Maintenance when towing trailer ...	5-27

When the vehicle has stopped due to a failure **5-28**

In the event of an accident **5-29**

Tips when an accident or a malfunction occurs on the expressway	5-29
---	------

In the event of a fire **5-30**

Placing an extinguisher in the vehicle	5-30
How to use the extinguisher.....	5-30
Checking and maintaining the extinguisher	5-30

In the event of a heavy snow **5-31**

6. Periodic Checking and Maintenance

Scheduled maintenance services - gasoline engine **6-2**

Scheduled maintenance services (under severe condition) - gasoline enginei **6-5**

Checking the engine room **6-8**

Engine oil **6-9**

Level Check.....	6-9
Replenishment	6-9

Function of engine oil	6-10
Consumption of Engine Oil.....	6-10

Engine care	6-10
-------------------	------

Change interval	6-11
-----------------------	------

Specification and capacity.....	6-11
---------------------------------	------

Warnings and cautions when checking.....	6-11
Engine	6-12

SAE viscosity classes	6-12
-----------------------------	------

Engine coolant **6-13**

Level Check.....	6-13
Service Interval.....	6-13

Replenishment	6-13
Air cleaner	6-15
Cleaning	6-15
Change	6-16

Brake and clutch fluid (with M/T)..... **6-17**

Specification and Replacement	6-17
Level Check and Replenishment ...	6-17

Washer fluid..... **6-18**

Top up washer fluid.....	6-18
--------------------------	------

Battery **6-19**

Battery Maintenance.....	6-19
Specification	6-19

Spark plugs - Gasoline engine **6-21**

Checking the wipers and replacing the blade **6-22**

Replacing the blade of windshield wiper	6-22
Replacing the blade of rear window wiper	6-22
Specifications of wiper blade	6-22

Checking and replacing fuses and relays..... 6-24

- Engine compartment fuse and relay box..... 6-24
- Interior fuse box 6-24
- Checking and replacing fuses 6-25

Checking and replacing the lamps..... 6-26

- Specifications of lamps and checking..... 6-26
 - Specifications and quantity of lamps and bulbs 6-26
 - Checking the lamps..... 6-27
 - Headlamp desiccant* 6-27
- Position of exterior lights and lamps ..6-28
- Replacing exterior lamps 6-29
 - Replacement of headlamp desiccant..... 6-29
 - Headlamp absorbent* 6-29
 - To replace license plate lamp 6-29
 - To Replace Rear Combination Lamp..... 6-30
- Position of interior lamps..... 6-32
- Replacing the interior lamps 6-33
 - Center Room Lamp (Bulb) 6-33

- Replacing the sun visor/mirror lamp (Bulb) 6-33
- Glove Box Lamp 6-34

Replacing the A/C filter..... 6-35

Checking the tires and wheels..... 6-37

- Checking the tire pressure 6-37
- Prescribed tire inflation pressure 6-37
- Wheel alignment status and the balance between tires and wheels 6-37
- Checking the status of tire wear 6-38
- Rotating the tire positions..... 6-38
- Snow tire 6-38
- Tire chain 6-39
- Cautions for checking the tires and wheels 6-39

Vehicle management during winter..... 6-41

- Starting the engine and driving the vehicle 6-41
- Managing the engine oil..... 6-41
- Managing the engine coolant..... 6-41
- Managing washer fluid 6-41
- Installing a snow tire 6-41

- Managing the A/C..... 6-42
- Other maintenance..... 6-42
- Cautions for parking during winter..... 6-43

Warnings for self-maintenance- 6-44

7. Index

Table of Pictures

Find the desired information using a picture easily even if you do not know the title of the desired information.

Front section

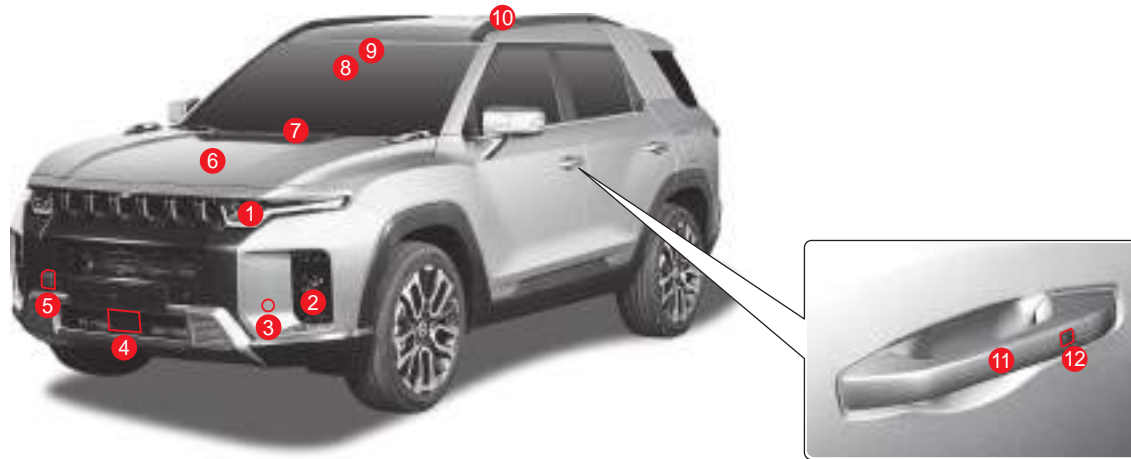

1 Head light (head light).....	3-37	7 Windshield wiper	3-54	9 Auto light/rain sensor.....	3-45/3-55
• Smart High Beam (SHB)	3-41	8 Front camera module (FCM).....	4-126	10 Roof rack	3-91
• Daytime running light (DRL)	3-40	• Autonomous Emergency Braking (AEB).....	4-148	11 Door handle.....	4-14, 4-17
2 Front fog light.....	3-37	• Lane Departure Warning (LDW)	4-165	• Using emergency key	4-17
3 Front obstacle detection sensor.....	4-182	• Lane Keeping Assist (LKA)	4-169	12 Door outside handle switch.....	4-14
4 Front radar	4-126	• Centering Lane Keeping Assist (CLKA)	4-176		
• Intelligent cruise control.....	4-118	• Front Vehicle Start Warning (FVSW)	4-181		
5 Front towing hook	5-22				
6 Engine hood	3-33				

Rear section

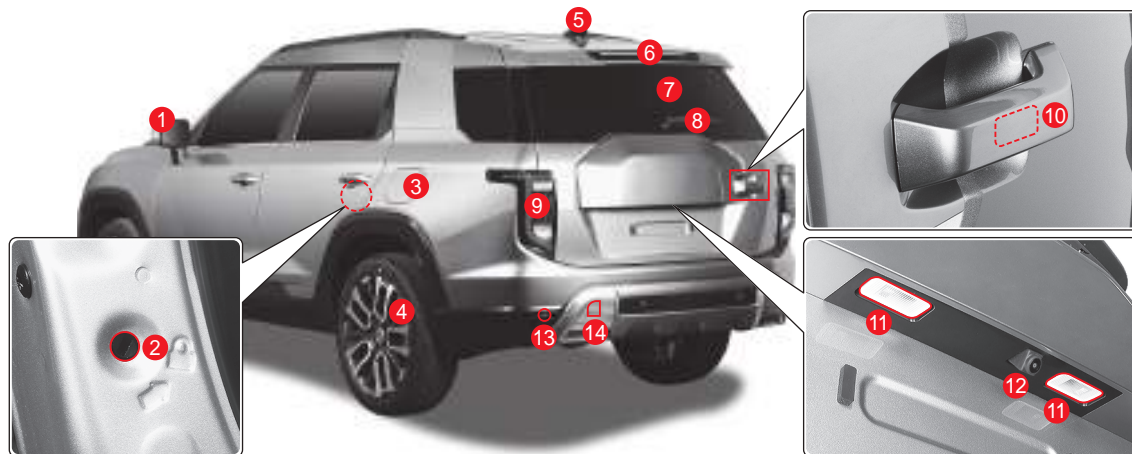

1 External mirror heater	3-66	5 Antenna (GPS, radio)	3-78	10 Tailgate open button	3-25
2 Child safety door lock / unlock	3-5	6 High mounted stop lamp	3-72	11 License plate lamp	3-62
3 Fuel inlet	3-34	7 Rear window heater	3-66	12 Rear camera	4-186
4 Tire and wheel	6-37	8 Rear window wiper	3-55	13 Rear obstacle detection sensor	4-182
• Tire pressure monitoring system		9 Rear lamp	3-36, 6-26, 6-28	14 Rear towing hook	5-22
(TPMS)	2-29				

Driver door and steering wheel section

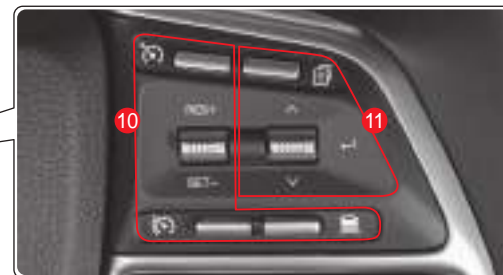

1 Driver door open lever	3-36	6 Foot brake	4-135	10 Cruise control switch	4-112
2 Window button	3-18	• Emergency stop signal (ESS)	4-138	11 Instrument cluster menu and control buttons	4-38
3 Outside mirror angle control switch	3-56	7 Steering wheel telescoping/tilt control lever	3-73	12 Audio system control button	3-77
4 Engine hood opening lever	3-33	8 Light switch	3-37	13 Lane departure warning (LDW) switch/ Lane keeping assist (LKA) switch	4-165/4-169
5 Interior fuse box	6-24	9 Instrument cluster	4-21		

Interior front view

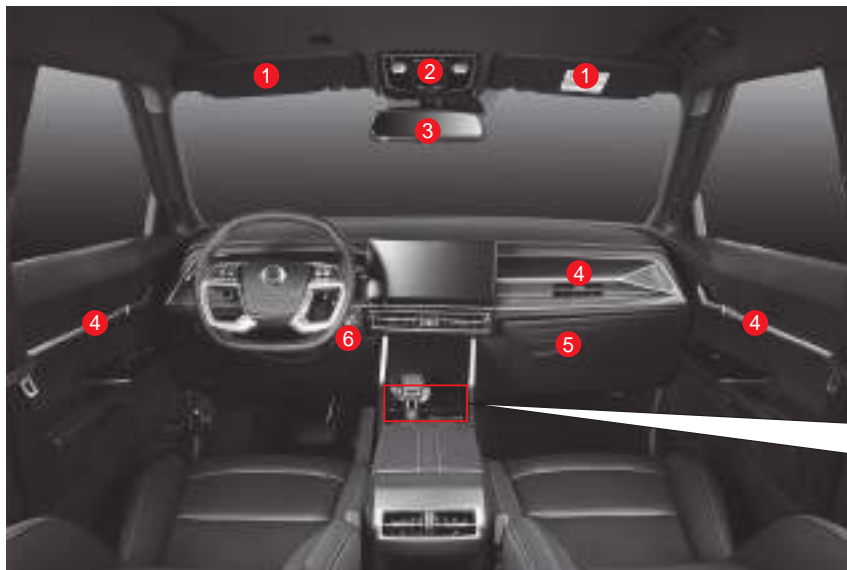

- | | | | | | |
|----------------------------------|------|---|------|--|------|
| 1 Sun visor..... | 3-81 | 3 Inside rear view mirror | 3-57 | 6 START/STOP switch | 4-2 |
| 2 Overhead console assembly..... | 3-47 | 4 Mood lamp (front door & passenger
IP side) | 3-49 | 7 Automatic transmission selector lever..... | 4-95 |
| • Sunroof control switch..... | 3-22 | 5 Glove box..... | 3-84 | 8 USB port | 3-76 |
| • Front room lamp | 3-47 | | | 9 Wireless phone charger system | 3-86 |
| • E-call | 3-50 | | | | |

Interior front view (Buttonless integrated control panel)

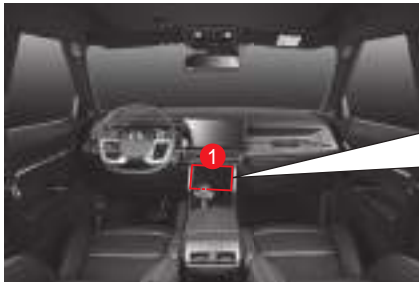

- | | | |
|---|---|---|
| 1 Buttonless integrated control panel configuration 3-69 | 7 Seat belt reminder warning lamp 2-2 | 13 Front obstacle detection ON/OFF switch 4-182 |
| 2 Dehumidify window glass (Auto defogger system) 3-67, 3-68 | 8 Heater and A/C controller 3-62 | 14 AWD LOCK switch 4-106 |
| 3 Glass heater switch 3-66 | 9 Front seat heater/ventilation switch 3-14 | 15 AUTO HOLD switch 4-146 |
| 4 Favorite menu 3-72 | 10 LTCM screen OFF switch 3-70 | 16 ESC OFF switch 3-71 |
| 5 Tailgate interior switch 3-26 | 11 ISG OFF switch 4-109 | 17 HDC switch 4-141 |
| 6 Steering wheel heater switch 3-73 | 12 Driving mode switch 3-71 | 18 Headlamp leveling switch 3-71 |
| | | 19 Interior illumination control switch 3-71 |

Rear seats



1	Rear seat	3-11
2	Baby car seat	2-11
3	Rear seat door open lever	3-36
4	Rear seat window button	3-19
5	Rear seat warmer button	3-16
6	USB charging port	3-79
7	Rear cup holder and armrest	3-83
8	Rear seat belt	2-6
9	Rear seatback release lever	3-12

Luggage compartment

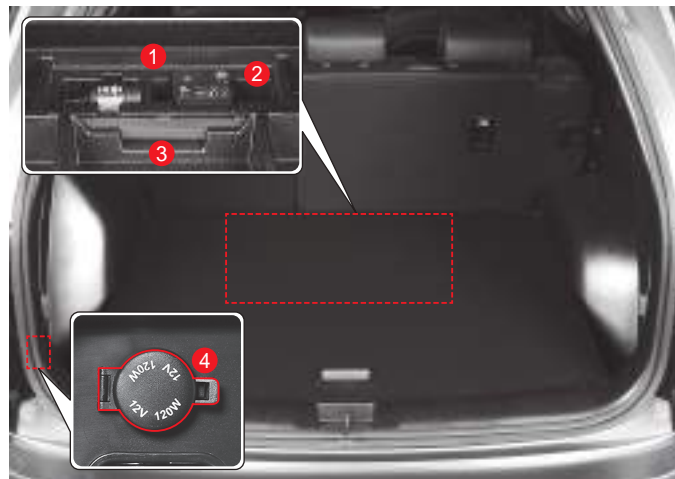

1	Service kit for tire repair	5-9
2	OVM tools	5-2
3	Warning triangle	5-2
4	Power socket (left side of luggage compartment)	3-80

Engine room

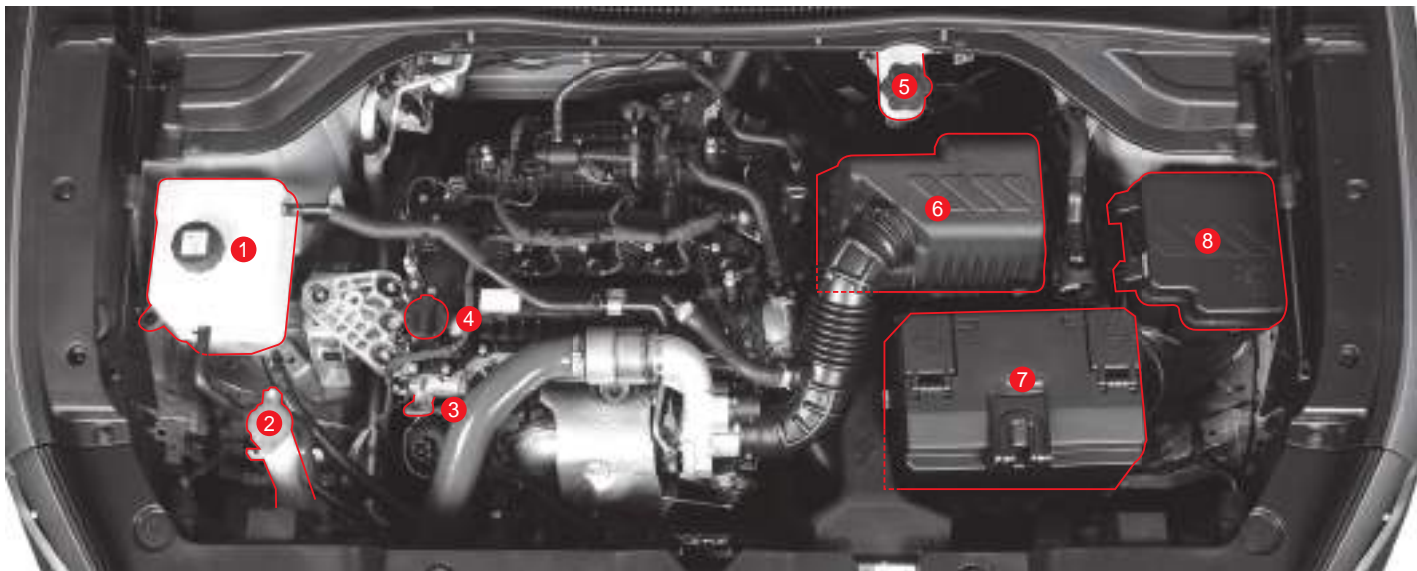

1 Engine coolant reservoir 6-13	4 Engine oil inlet 6-9	7 Battery 6-19
• Checking engine coolant 6-13	• Adding and replacing engine oil 6-9	• Checking and replacing the battery 6-19
2 Washer fluid inlet 6-18	5 Brake and clutch fluid reservoir 6-17	8 Engine compartment fuse and relay
• Checking and adding washer fluid 6-18	• Checking brake and clutch fluid 6-17	box 6-24
3 Engine oil level gauge 6-9	6 Air cleaner 6-15	• Checking and replacing fuses 6-25
• Checking engine oil 6-9	• Cleaning the air cleaner and	
	replacing the filter 6-15	

Warning lights and indicators









Image	Meaning/Relevant page
	Seat belt warning lamp 2-2, 4-25
	Air bag warning lamp 2-20, 4-25
	Global warning light..... 4-31
	Immobilizer/Smart key warning light 2-35, 4-26
	Engine oil pressure warning light 4-25
	Charge warning light 4-26
	Engine overheat warning lamp..... 4-26
	SSPS warning lamp 4-27









Image	Meaning/Relevant page
	Brake warning lamp 4-27, 4-137
	ABS (Anti-Lock Brake System) warning light 4-28, 4-137
	Parking brake ON indicator (red) 4-27, 4-137
	Electronic parking brake (EPB) warning lamp (orange)..... 4-29, 4-143
	Engine check indicator 4-29, 5-7
	Steering wheel heater indicator..... 4-30
	Electronic stability control system (ESC) ON indicator/ warning light 4-30, 4-139
	ESC OFF indicator 4-30, 4-139









Image	Meaning/Relevant page
	Low fuel level warning light 4-31
	Autonomous Emergency Braking System (AEBS) warning light 4-31, 4-148
	AEBS OFF indicator 4-32, 4-148
	Illumination ON indicator ... 4-33
	Front fog light ON indicator 4-33
	SHB indicator..... 4-33
	High beam indicator 4-34
	Turn signal/hazard warning lamp..... 4-34











Image	Meaning/Relevant page
	Hands-off warning lamp 4-35
	Door ajar warning lamp 4-37
AUTO HOLD	AUTO HOLD indicator/warning light 4-29, 4-146
	HDC ON indicator/warning light 4-32, 4-142
	LKAS (LDWS) indicator/warning lamp <ul style="list-style-type: none"> • Lane departure warning (LDW) 4-32, 4-166 • Lane keeping assist system (LKA) 4-32, 4-169
WINTER	Winter mode indicator 4-35
SPORT	SPORT mode indicator 4-35

Image	Meaning/Relevant page
	ISG indicator/warning light 4-35
	ISG OFF indicator 4-36
	4WD CHECK warning light 4-36
	4WD LOCK ON indicator 4-36
	Master symbol 4-37
	Centering lane keeping assist (CLKA) indicator / warning lamp 4-33, 4-176
120 km/h	Over speed (120 km/h) (GCC only) 4-22, 4-37
	Rear fog lamp ON indicator 4-33

<https://www.automotive-manuals.net/>

1. Vehicle Information and Safety Precautions

You can check helpful information for driving and managing the vehicle safely and conveniently.

Information regarding the vehicle identification, specifications, check points before driving the vehicle, safety precautions while driving, and vehicle maintenance methods is provided.

Installation of ADR (Accident Data Recorder) and provision of information

This vehicle has an ADR (Accident Data Recorder).

The ADR (Accident Data Recorder) is a device that can record and check the driving information of the vehicle (vehicle speed and operation status of brake pedal and acceleration pedal, etc.) for a certain period of time before and after an accident, such as a car crash.

The ADR (Accident Data Recorder) helps to better understand an accident situation.

Precautions for potentially hazardous seat belt related goods



Warning

When potentially hazardous seat belt related goods are used, the safety of passengers will be seriously endangered. Never use these goods.

Do not use the clip to disable the seat belt alarm



When this clip is inserted into the seat belt buckle, the seat belt is recognized as fastened, so the seat belt warning lamp and alarm are not activated.

This leads to no fastening of the seat belt, and it is very dangerous when an accident occurs.

Do not use the seat belt stopper



When it is installed on the seat belt, it hinders the normal automatic locking function of the retractor and lowers the performance of the seat belt.

Do not use playroom mat



When it is installed in the rear seat, it will lead to not fastening seat belts and car seats, and it is very dangerous when an accident occurs.

Precautions for the reduction of non-crash incidents



Warning

A part of your body may get stuck or hit and get seriously injured when opening and closing the doors. Caution should be taken.



- When you open and close the doors, a part of your body such as your finger or head may get stuck or hit and get seriously injured. Open and close the doors after ensuring that no part of your body is stuck or hit.



- When you open or close the trunk (tail gate), a part of your body such as your finger or head may get stuck or hit and get injured. Open or close the trunk after ensuring safety.
- The trunk (tail gate) is raised or lowered automatically at below or over a certain level. Always take caution to avoid your face or head from getting hit or your hand from getting stuck.



- Close the windows after checking that other passengers' hands or heads are away from the windows. This is especially important for children, who may get a serious injury, such as suffocation if their head gets stuck.
- When you pull the switch continuously to raise the window at a position where something is pinched first without operating the one touch auto close function, the anti-pinch function will not operate.
- Especially when a part of a child's body is on the window, a certain amount of force (resistance) is not applied to the window, so the anti-pinch function may not operate. Make sure to check before closing the windows.

KG Mobility Corporation environment-related policies aim at comprehensive protection of the environment. This is also a way to save natural resources that become the basis of human survival on earth, and meet and harmonize the demands of nature and mankind.

You can contribute to the protection of the environment by operating our vehicle in an eco-friendly way.

Fuel consumption, engine speed, transmission control and wear of brakes and tires are influenced by driving conditions and habits.

Observe the following content and participate in the protection of the environment.

Driving conditions

- Avoid short trips since it increases fuel consumption relatively.
- Always check if the tire inflation pressure is appropriate.
- Unload unnecessary goods from the luggage compartment.
- Always check the fuel efficiency.
- Have your vehicle checked periodically.



Driving habits

- Do not depress the accelerator pedal when starting the engine.
- Drive off in the vehicle slowly.
- Keep a safe distance with the vehicle ahead and drive carefully.
- Avoid frequent acceleration or deceleration.
- Avoid sudden acceleration, deceleration, or stops.
- In manual mode, shift the gears properly and avoid exceeding 2/3 of the maximum engine RPM in each gear.
- Avoid warming up the vehicle while stopping.
- Turn off the engine when you stop the vehicle for a long time.

Recycling

- Information about eco-friendly product development and vehicle recycling can be found on the KG Mobility Corporation website www.kg-mobility.com/en

1. TIRE PRESSURE MONITORING SYSTEM

CE	<p>Hereby, KG Mobility, declares that the in-vehicle mounted radio systems are in compliance with the essential requirements and other relevant provisions of Directive 1999/5/EC</p>	EU
FCC	<p>Model: TSSSG4G5 and TSSRE4Db FCC ID: OYGTSSRE4DB ORD. No: 14778/DFRS19614/F-50 This device complies with Part 15 of the Federal Communications Commission (FCC) rules. Operation is subject to the following two conditions:</p> <ol style="list-style-type: none"> (1) this device may not cause harmful interference, and (2) this device must accept any interference received, including interference that may cause undesired operation. <div style="border: 1px solid black; background-color: #f8d7da; padding: 5px; margin: 10px 0;"> <p style="text-align: center;"> Warning</p> <ul style="list-style-type: none"> Changes or modifications not expressly approved by the party responsible for compliance could void the user's authority to operate the equipment. </div>	AMERICA
CU TR	<p>LOGO</p>  <p>Certificate in the user manual due to product size Tire Pressure Monitoring System Model: TSSRE4Db The device passed all the conformity assesment procedures to CU TR.</p>  EAC mark in the user manual due to product size.	CIS

2. FOB/FOLDING

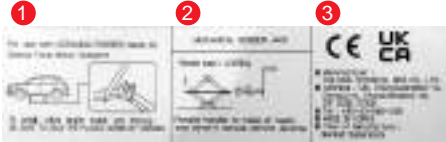

FCC	<p>FCC ID: DEO-MT-FLIP01</p> <p>This device complies with Part 15 of the Federal Communications Commission (FCC) rules.</p> <p>Operation is subject to the following two conditions:</p> <ol style="list-style-type: none"> (1) this device may not cause harmful interference, and (2) this device must accept any interference received, including interference that may cause undesired operation. <div style="border: 1px solid black; background-color: #ffe6e6; padding: 5px; margin-top: 10px;"> <p style="text-align: center;">! Warning</p> <ul style="list-style-type: none"> Changes or modifications not expressly approved by the party responsible for compliance could void the user's authority to operate the equipment. </div>	AMERICA
TR	<p>LOGO</p>  <p>Certificate in the user manual due to product size</p>	CIS

3. JACK LABEL

CE	 <ol style="list-style-type: none"> 1 Model name 2 Maximum allowable load 3 Jack manufacture <div style="border: 1px solid black; background-color: #ffe6e6; padding: 5px; margin-top: 10px;"> <p style="text-align: center;">! Caution</p> <ul style="list-style-type: none"> When using the jack, set your parking brake. When using the jack, stop the engine. Do not get under a vehicle that is supported by a jack. The designated locations under the frame When supporting the vehicle, the base plate of jack must be vertical under the lifting point. Shift into Reverse gear on vehicles with manual transmission or move the shift lever to the P (Park) position on vehicles with automatic transmission. The jack should be used on firm level ground. </div>	EU
----	---	----

1

4. Compressor, Jack

CE	LOGO  (1) Description Model: CE certified parts (2) Representative: KG Mobility European Parts Center B.V. (3) Address: IABC 5253&5254, 4814RD Breda, The Netherlands	EU
UKCA	LOGO  (1) Description Model: UKCA certified parts (2) Importer: KG Mobility UK Ltd (3) Address: G Offices, Parsonage Road, Stratton St. Margaret, Swindon, Wiltshire SN3 4RN	UK

Vehicle identification

The identification numbers including the vehicle identification number and the engine number are the unique information of the vehicle. If you know this information, it is very convenient for making inquiries about the vehicle or placing an order for a component or accessory.

Certification label

The certification label includes information including the vehicle identification number, tire inflation pressure, vehicle weight, and color necessary for maintaining the vehicle properly.

TYPE A

KG MOBILITY	
1-	2-
DATE OF MANUFACTURE	

KG Mobility European Parts Center B.V.
Contact address: SMC 5253 & 5254, 4814RD Breda, The Netherlands

TYPE B

KG MOBILITY		
GOODS VEHICLE		KG
GROSS VEHICLE WEIGHT		KG
TOTAL PAINT WEIGHT		KG
FUEL TANK CAP.		KG
WHEEL HUB CAP.		KG
WHEEL DISC CAP.		KG
WHEEL RIM CAP.		
BODY PAINT COLOR		
DATE OF MANUFACTURE		

TYPE C

SeangYong Motor Co., Ltd.	
1-	2-
DATE OF MANUFACTURE	

Seangyong European Parts Center B.V.
Contact address: SMC 5253 & 5254, 4814RD Breda, The Netherlands

TYPE D

SsangYong Motor Co., Ltd.		
GOODS VEHICLE		KG
GROSS VEHICLE WEIGHT		KG
TOTAL PAINT WEIGHT		KG
FUEL TANK CAP.		KG
WHEEL HUB CAP.		KG
WHEEL DISC CAP.		
WHEEL RIM CAP.		
BODY PAINT COLOR		
DATE OF MANUFACTURE		

The certification label is attached to the driver's door sill (B pillar).

Vehicle Identification Number (VIN)

The vehicle identification number (VIN) is the identification number that includes vehicle model, manufacturing country and manufacturing year.



It is engraved on the front RH seat mounting member.

Vin Label*

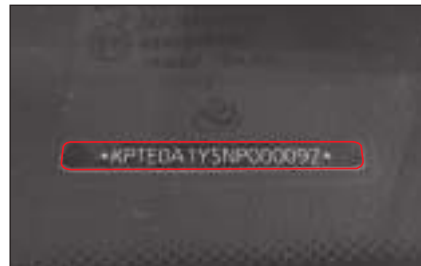

The VIN is stamped on top of the instrument panel.

Engine number

The engine number is the identification number including the type of fuel, engine type and displacement, etc.

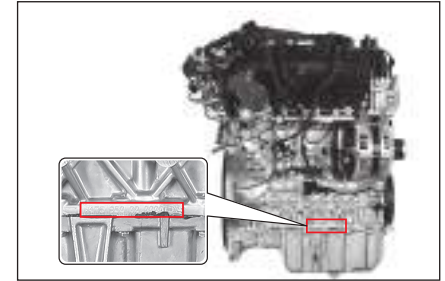

Gasoline Engine: The engine number is stamped on the bottom surface of the cylinder block behind the intake manifold.

1

Dimensions

Front



Top



Rear



Side

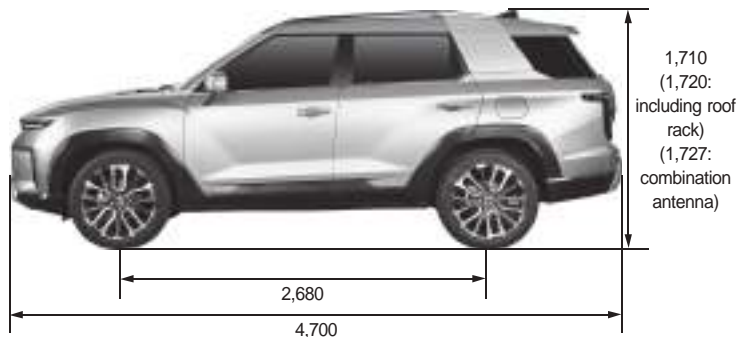

* (): Optional

SPECIFICATIONS (I)

* () Optional

Descriptions		Gasoline 1.5 Engine	
General	Overall length (mm)	4700	
	Overall width (mm)	1890	
	Overall height (mm)	1710 (1720: including roof rack) (1727: combination antenna)	
	Gross vehicle weight (kg)	A/T	4WD: 2170, 2WD: 2080
		M/T	2WD: 2050
	Curb vehicle weight (kg)	A/T	4WD: 1718, 2WD: 1628
		M/T	2WD: 1598
	Fuel	Gasoline	
Fuel tank capacity (ℓ)	50 (EU), 47 (GEN)		
Engine	Engine	G15DTF	
	Number of cylinders/Compression ratio	4 / 9.5:1	
	Total displacement (cc)	1497	
	Camshaft arrangement	DOHC	
	Max. power	120 kW / 5000~5500 rpm	
	Max. torque	280 Nm / 1500~4000 rpm	
	Idle speed	700 ± 50 rpm	
	Cooling system	Water-cooled / forced circulation	
	Coolant capacity (ℓ)	7.0	
	Lubrication type	Gear pump, forced circulation	
	Max. oil capacity (ℓ) (when shipping)	4.5	
	Turbocharger and cooling type	Turbocharger, water-cooled	

* () Options, vehicle weights and gross weights are based on the maximum values and they depend on vehicle options and specifications.

SPECIFICATIONS (II)

* (): Optional

Descriptions		Gasoline 1.5 Engine	
Manual Transaxle	Operating type	Floor change type	
	Gear ratio	1st	3.538
		2nd	1.913
		3rd	1.152
		4th	0.829
		5th	0.689
		6th	0.587
Reverse	3.000		
Automatic Transaxle	Model	Electronic 6-speed	
	Operating type	Floor change type	
	Gear ratio	1st	4.044
		2nd	2.371
		3rd	1.556
		4th	1.159
		5th	0.852
6th		0.672	
Reverse	3.193		
Transfer Case	Model	AWD	
	Type	On demand type	
Clutch (M/T)	Operating type	Hydraulic (CSC) type	
	Disc type	Dry single diaphragm type	

SPECIFICATIONS (III)

* (): Optional

Descriptions			Gasoline 1.5 Engine
Power Steering	Type		Rack and pinion (EPS)
	Steering angle	Inner	31.82
		Outer	37.72
Rear Axle	Drive shaft type	Independent suspension	Ball joint type
	Axle housing type		IRDA type
Brake	Master cylinder type		Tandem type
	Booster type		Vacuum assisted booster type
	Brake type	Front wheel	Disc
		Rear wheel	Disc
	Parking brake		EPB
Suspension	Front suspension		Macpherson + Coil spring
	Rear suspension		Multi link + Coil spring
Air Conditioner	Refrigerant (capacity)	Type A	R-1234yf (530 ± 30g)
		Type B	R-134a (570 ± 30g)
Electrical	Battery type / Capacity (V-AH)	ISG	AGM / 12 - 70
		NON-ISG	MF / 12 - 60
	Starter capacity (V-KW)	ISG	12 - 1.4
		NON-ISG	12 - 0.9
Alternator capacity (V-A)		14V - 130A	

1

Precautions for the modification of the vehicle and structural alteration



Warning

Unauthorized vehicle modification, structural alteration and installation of a component may cause car trouble or a fatal accident. Warranty repair will not be provided in case of product malfunction.

- The vehicle you purchased is made of a lot of precision parts passed through a large numbers of researches and tests, and these parts are linked and operate systematically.
- Modifying or changing any part arbitrarily or installing an unauthorized device may cause car trouble and affect the vehicle's performance, durability, and safety. It may lead to a fatal accident.
- Also, warranty repair will not be provided for a modified part as well as a problem that occurred due to the modification, even during the warranty period.

Do not install a separate accessory or auxiliary device to the vehicle operation device arbitrarily.

- Extending the gear shift lever or installing accelerator pedal or brake pedal pads available in the market arbitrarily may cause an operation mistake due to a change in the operating force of the vehicle. In such case, vehicle damage as well as a serious fatal accident may occur.

Do not modify the engine, driving, and exhaust systems.

- Do not adjust the preset value in the fuel supply system, intake, exhaust, and electric systems arbitrarily, or replace with or add a non-standard part in order to increase the engine output or adjust the exhaust sound. Doing so may cause a serious problem with the vehicle's durability. It is illegal.
- In particular, the modification to an LPG vehicle may adversely affect the vehicle's performance and durability. The engine system as well as the transmission and the wheel alignment are excluded from the warranty.

Do not modify the audio system or install additional electronic devices such as wireless communication equipment, rear view camera, TV, and remote starting devices.

- The electrical system of this vehicle consists of electric wires and fuses for installing standard electronic devices.
- Connecting a number of electric wires to the existing wire for installing various additional electronics may cause overloading, resulting in damage to electronic devices and a risk of fire.
- In addition, drilling for installing an antenna may cause the vehicle to rust.

Do not install non-standard tires or wheel-related parts.

- If you install wider or larger tires than the vehicle specifications, the tires and adjacent parts may come into contact with each other and result in wear and damage to the power train system when you operate the steering wheel or drive on an unpaved road.
- In addition, the degradation of driving performance may occur due to an increase in the fuel consumption and braking distance, vibration of the vehicle body, and degraded handling of the steering wheel, and an impact may occur when shifting with the automatic transmission.
- Moreover, it may affect the speedometer and odometer, displaying an incorrect driving speed or a driving distance longer than the actual driving distance.
- If you install a wheel dust cover in order to improve the appearance of the tires, friction heat generated during braking is not released smoothly, causing the fade or vapor lock phenomenon. This may lead to the degradation of braking performance and cause a serious problem.

Do not install a sunroof available in the market or replace with colored glasses arbitrarily.

- If you cut the roof of the vehicle and install a sunroof, rust or water leaks may occur in the cut part.
- Installing colored glasses to improve the appearance and block UV rays after the vehicle is shipped may cause water leaks. Do not install such glasses.

Do not modify the floor inside of the vehicle arbitrarily.

- Do not install an auxiliary article such as floor coverings on the floor inside the vehicle to enhance the cushioning or convenience for cleaning. Doing so may damage the operating device of various electronic systems and electrical wires, and hinder the function of the seat rail that moves the seat forward and backward.
- Also, the locking system to fix the position of the seats may not operate properly. In such case, the seats may move forward or backward, causing an accident, when driving on a downhill road or an uphill road.

Do not replace the seat with a new one with a different function, or install a separate seat cover.

- There are various types of seats according to the function and role even for the same vehicle type and electric wiring has been applied accordingly.
- Do not bring and over-use or modify an adjacent electrical wire in order to replace a seat with a new one with different functions. In such case, it may damage electronic devices and create a risk of fire due to overloading.
- Replacing a seat cover incorrectly may damage electrical devices due to a short circuit or disconnection, or cause poor ventilation, fire and abnormal noise.

Do not install a bumper guide or a guide bar available in the market.

- If you install a bumper guide or a guide bar arbitrarily, problems such as difficulty in parking and stopping due to an increase in the total vehicle length, the waste of fuel due to an increase in the vehicle weight, and the occurrence of rust on the installation holes may occur. In addition, more serious injury may occur in the event of a collision accident due to the absence of a shock absorber in the bumper guide.

Do not attach a functional product that may decrease the driving resistance such as stickers, molding, air dam, or windproofing products.

- Adhesives of the stickers may damage the coated surface of the vehicle. When drilling is carried out on the vehicle in order to attach molding and other functional parts, the drilled area may rust or abnormal noises may occur while driving.
- Especially if such parts are not attached firmly, such parts may fall off while driving, causing damage to the vehicle as well as a fatal accident.

Checking before driving

Daily inspection



- Check the vehicle once a day before driving.
- Check the engine coolant, engine oil, brake fluid, washer fluid, and belts for abnormality.
- Check for leaks from the battery and the radiator.
- Check the bottom of the vehicle to see if there is an oil or liquid leak.
- Clean the front and rear windshields, rear glasses, side mirrors and room mirror.
- Check the operating status of the various lamps.
- Make sure that there are no obstacles that may hinder the driving around of the vehicle.

Checking engine room

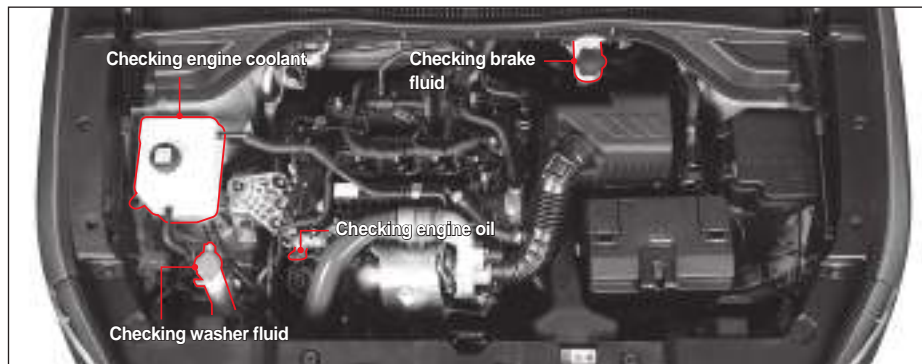

Checking engine coolant



- Check the engine coolant after cooling the engine properly on level ground.
- Check if the coolant level is between the "MAX" mark and the "MIN" mark on the surface of the coolant reservoir. If the level is near or below the "MIN" mark, add coolant.

Checking engine oil



- Check the engine oil after stopping the engine on level ground and waiting for more than 5 minutes.
- Check if the oil level is between the "MAX" mark and the "MIN" mark on the oil level gauge. If the level is near or below the "MIN" mark, add oil.

Checking brake fluid (clutch fluid)



Check if the brake fluid (clutch fluid) level is between the "MAX" mark and the "MIN" mark. If the level is near or below the "MIN" mark, add brake fluid (clutch fluid).

Checking washer fluid

Check the level of washer fluid on the washer fluid tank and add as needed.



Caution

- If the level of engine coolant and various oils drops below the "MIN" mark, have your vehicle checked by KG Mobility Authorized Service Center.

Checking belts

Start the engine and see if there is any abnormal noise.

Have the belts checked by our service center according to the periodic inspection and replacement interval table.

Checking tires



Warning

- **Maintain the tire pressure in a proper condition. Driving the vehicle at a high speed with low tire pressure may cause the tires to burst due to the standing wave effect, resulting in a risk such as a rollover.**
- **Check to see if the wheel nuts (bolts) are tightened. Improperly tightened wheel nuts (bolts) can cause an accident.**
- **Using wheel and tire other than the specified sizes could cause unusual handling characteristics and poor vehicle control, resulting in a serious accident.**
- **The use of tire sizes other than the specified sizes may cause abnormal operation of the steering wheel, increased fuel consumption, increase braking distance, vibration, improper operation of ABS/ESC, or uneven tire wear. It may also damage to the powertrain of the vehicle.**
- **Use only the same tires from same tire manufacturer for all the wheels. Otherwise, the powertrain may be damaged.**

- Always check the tread and side of the tires to see if there is a sign of wear, cracks, or damage.
- Check the conditions and pressure of the temporary (spare) tire as needed and always keep it available. The temporary tire should be replaced with a regular tire as soon as possible.
- Check the conditions of the emergency puncture service kit. The air compressor and sealant canister should be available at any time.
- Check the tire inflation and wear everyday and replace if necessary.



What is the standing wave phenomenon?

The standing wave phenomenon is the occurrence of a wave-shaped wrinkle on a tire with insufficient inflation pressure during high speed driving.

During driving, a tire that has normal inflation pressure repeats compression and restoration, but when a tire with insufficient inflation pressure rolls on the road with high speed, the tire will be compressed significantly and it comes into contact with the road surface again before it is fully restored. If such a situation occurs repeatedly, the standing wave phenomenon will appear.

If the standing wave phenomenon persists, a significant amount of heat is generated on the tire and the tire will be blown out in the end.

Checking the instrument cluster



Check if all the indicators and warning lamps are displayed correctly on the instrument cluster with the ignition switch in ON position.

Also, check if all gauges (fuel gauge, vehicle speed gauge, engine RPM gauge, etc.) are operating properly.

Checking the parking brake

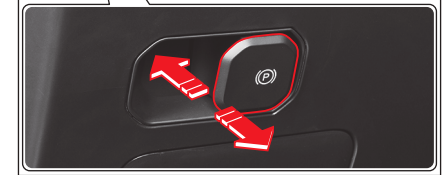

Operate the EPB (Electric Parking Brake) switch and check the operating sound and operation status.

If the parking brake is not applied, have the vehicle checked and repaired by a near-by KG Mobility Authorized Service Center.

Checking the pedals

Check the operation status of the brake pedal, clutch pedal and the accelerator pedal.

If the operation status of the pedal is abnormal in comparison to its normal status, have it checked and repaired by KG Mobility Authorized Service Center.

Cleaning up near the driver's seat

Keep the space near the driver's seat clean all the time. Never leave any object that hinders driving.

Always clean up the space near the driver's seat before driving.



Warning

- **An empty bottle or an article below the pedal hinders the pedal operation and may cause an accident.**
- **If the floor mat is not fixed or is too thick, it may hinder the pedal operation and cause an accident.**

Advisable driving position



Maintain an advisable position for safe and comfortable driving.

- Sit upright on the driver seat with the hip against the seat cushion.
- Adjust the position and height of driver seat in a way that the brake pedal (clutch pedal) can be depressed to the end comfortably.
- With your back against the seat back, adjust the position and height of the seat back and steering wheel so that you can rest your wrists on the top of the steering wheel.
- Adjust the height of the headrest in a way that the center of the headrest is aligned with the driver's eye level.



Warning

- **Do not wear shoes such as slippers or high heels that may hinder driving. Such shoes may hinder the accelerator pedal or brake pedal operation and cause an accident.**

Adjusting the seat, headrest, steering wheel, and mirrors

- Adjust the seat, headrest, steering wheel, and mirrors before driving the vehicle.
- If your steering wheel is adjustable, adjust it to an appropriate height and angle that fits your body and drive the vehicle.
- Adjust the rear glasses, side mirrors and room mirror to an angle that you can see the rear view well.



Warning

- **If an additional adjustment is necessary while driving, make sure to stop the vehicle at a safe place and make the adjustments. Adjusting while driving may hinder driving, causing an accident.**

Wearing the seat belt correctly



- Make sure that all occupants inside the vehicle wear a seat belt.
- Wear the seat belt with your body closely against the seat cushion.
- A child who cannot wear a seat belt should be seated in the rear seat using child restraints.
- For a vehicle where an adjustable top shoulder strap fixing device is provided, wear the seat belt by adjusting the shoulder strap control device to your body type.

Warning

- Do not wear the seat belt under the arm.



- Each seat belt is for one person. Two or more persons should not wear one seat belt together.



- Do not lock the seat belt with a clip or a clamp.



- Insert the seat belt latch only to the relevant buckle.



Safety and cautions for driving

Danger

No drugged, drunk, distracted and drowsy (4D) driving



- Avoid drugged driving. It is an illegal act that may be more dangerous than drunk driving depending on the type and dosage of a drug.
- Avoid drunk driving. Judgment is impaired under the influence of alcohol, making safe driving impossible. It is also an illegal offense that puts the life of occupants in other vehicles in danger.

- Avoid distracted driving. Using a mobile phone or the navigation system, watching DMB, or eating while driving may decrease your concentration, making a risk of an accident higher. In particular, using a mobile phone or watching DMB while driving is an illegal offense that hinders safe driving. When it is inevitable, stop or park the vehicle in a safe place and use the relevant device.
- Avoid drowsy driving. Driving for a long period of time without taking a rest will lead to drowsy driving that may cause an accident. Take a rest at least every 2 hours for safety.

Warning

Cautions for air bag

- The air bag system is an auxiliary safety device. Wearing the seat belt properly can minimize injury.
- Do not apply impact to the air bag by hand or with other articles. Doing so may cause the air bag to deploy.
- Do not place any object on, or attach a sticker or other accessories to the air bag inflation location where the air bag is installed. You may be injured by those objects during deployment.

- A passenger who is smaller than 140 cm should sit in the rear seat. Otherwise, the passenger may get injured during deployment.
- A safety device for infants and children should be installed on the rear 1st row. Installing it on the front seat may cause a serious injury or death if the air bag is deployed.
- A pet should be restrained in the rear seat using a dedicated safety device. A pet in the front seat may get injured if the air bag is deployed.
- When the air bag is deployed, the relevant components may be hot.
- A deployed air bag cannot be used again. Please replace it.
- The air bag system should be checked or replaced after 10 years from its installation even if the system has no abnormality. The air bag system should be checked or replaced by a professional technician in KG Mobility Authorized Service Center.
- Do not modify any part of the air bag system arbitrarily. Do not attach any other electrical device to the air bag system.



Warning

Precautions for infants, children, old people, or pregnant women



- Never leave an infant, a small child or an old person unattended in the vehicle. They may touch a device inside the vehicle, resulting in an accident. When the doors are locked and the windows are closed during summer, the temperature inside the vehicle will increase, resulting in suffocation.
- Do not allow children to use the ignition key, various switches or buttons, and additional devices without permission. Failure to do so may cause car trouble or even an accident. Their body may get caught in the door, window, or sunroof, and receive injury.
- Do not let an infant, a child or an old person sit in the front seat. The impact from the air bag expansion may cause serious injury or death. An infant or a small child should be restrained with a seat belt or protective gear in the rear seat attended by an adult.



Warning

An infant or a small child must be seated in the rear seat with protective gear



- An infant or a small child should be seated in the rear seat with an adult.
- An infant or a small child should be restrained with a seat belt or proper protective gear. Failure to do so may cause serious injury or death in the event of sudden braking or a collision accident.
- Apply the child protection lock system to the rear doors so that children in the rear seats cannot open the rear doors.
 Refer to "Child safety door lock" (p.3-5)



Warning

No sleeping in a sealed vehicle



- Never sleep in a parked car with all the windows closed. In particular, if you sleep with the air conditioner or heater turned on, you can suffocate to death due to a lack of oxygen.
- If you sleep in a sealed space with the engine running, the exhaust gas may flow in, putting you at risk of suffocation.
- While sleeping, you may accidentally touch the gear shift lever or accelerator pedal and cause an accident.
- If you step on the accelerator pedal continuously while sleeping, the engine and the exhaust system may be overheated, causing a fire.

 Warning

Do not drive with the doors or tailgate open



- Do not drive with the doors open. An occupant may fall out of the vehicle and suffer a serious injury.
- If you accidentally operate the door lever while driving and the door is open, it may cause a risk of a serious accident. In particular, do not allow a small child to touch the door lever while driving.
- Avoid driving the vehicle with the tailgate open. Exhaust gas may flow indoors, resulting in gas poisoning.
- If you drive the vehicle with the tailgate open, an article from the inside of the vehicle may fall out, causing an accident.

 Warning

Do not hold a part of your body out of the window or sunroof



- While driving or stopping, do not hold a part of your body such as a hand or head out of the window or sunroof. You may get injured by a passing vehicle or an obstacle.
- In particular, do not allow a child or a pet to hold their hand or head out of the window.

 Warning

Be careful not to have a part of your body caught when using the power window



- Use the power window only after checking that all passengers are safe.
- Before closing the window, check if a part of a passenger's body such as a hand or head is held out of the window and notify them that you will close the window.
- If a small child is seated in the rear seat, press the window lock switch to make the rear window switches inoperative.
 Refer to "Rear seat window lock function" (p.3-20)

 **Warning**

Check for any vehicles or persons passing by when getting out



- When you get out, make sure to check the rear and the front of the vehicle to see if there is any vehicle or person passing by. In particular, opening the door without checking a vehicle or a motor cycle approaching from the rear may cause damage to the vehicle as well as injury.
- Warn other passengers to check around before opening the door.

 **Warning**

Safe parking and stopping

- Never leave an infant or a child unattended in the vehicle with the doors and the windows locked after parking or stopping the vehicle. The temperature inside the vehicle may rise, resulting in suffocation or an accident.
- Always apply the parking brake while parking or stopping. Even a flat area may have a slope. Place the gear shift lever in the P (parking) position and always apply the parking brake.
- Do not stop or park on a steep road. The brake system may be released, causing the vehicle to move.
- When you park on a hillside road, make sure to apply the parking brake and place blocks under the wheels or adjust the wheels to face the wall.
- At this time, place the shift lever in the P (park) position for automatic transmission vehicles and in the 1st gear (uphill) or R (downhill) position for manual transmission vehicles.
- If the vehicle with an automatic transmission, do not use the P (park) position as an alternative to the parking brake, make sure the parking brake is firmly applied during parking.
- Do not park or stop at a place with flammable materials. The heated exhaust pipe may cause a fire.

- If the rear side of the vehicle is too close to a wall, warming up the vehicle for a long period of time, or idling the engine at a high speed may cause the wall to be discolored, or cause a fire due to the heat from the exhaust gas. Keep a proper distance.
- If possible, do not park the vehicle in a humid area or a poorly ventilated area.

 **Warning**

Warming up the engine correctly

- Drive after warming up the engine properly. Driving immediately after starting the engine may decrease the engine's life expectancy.
- Warm up the engine just until the coolant temperature gauge begins to move. The warming up period may vary according to the outside temperature.
- Do not depress the accelerator pedal and increase the engine RPM rapidly during the warming up period. Doing so may damage the engine.
- Do not warm up the engine excessively. Doing so increases the fuel consumption and air pollution.
- Do not warm up the engine in a sealed space. Exhaust gas may flow indoors, resulting in gas poisoning.



Warning

Do not stop the engine while driving

- Do not stop the engine while driving. Doing so may make the steering wheel heavier and lower the brake performance, becoming very dangerous.

However, if you need to stop the engine in an emergency situation while driving due to an accident or a vehicle damage, refer to the following.

☞ Refer to “Stopping the engine while driving (in the event of emergency)” (p.4-4)

No sudden starting, acceleration or braking

- Do not start, accelerate, or brake the vehicle suddenly. Doing so may increase the fuel consumption or cause an accident.
- Accelerate or decelerate the vehicle gently.

Driving on unpaved and mountain roads

- Before driving, check road conditions in advance to see if the road ends suddenly, or if there is enough space to make a U-turn for emergencies.
- In sandy or dry roads with much soil, the vehicle may slide easily. Keep your speed low and steady.
- Drive carefully on mountain roads, since the outer part of the road has a danger of collapsing.
- When driving downhill, downshift, and drive slowly by applying the engine brake.



Warning

In high mountain area

- The operation stability of diesel engine is not guaranteed in high mountainous area over 2,500 meters. The short trip such as passing through tunnel in this area is acceptable. However, do not keep driving there for a long time. If you drive your vehicle in very high altitude for long time, the engine could be damaged. The engine power, climbing ability and emission are subject to the altitude.

Driving on a snowy or icy road

- If possible, drive slowly.
- Since the braking distance is longer than usual, maintain a proper distance from the car ahead.
- Accelerating or braking suddenly may cause your vehicle to slide, resulting in an accident.
- When you drive on a frozen or slippery road, use the engine brake after decelerating properly. Applying the engine brake suddenly may cause your vehicle to slide, resulting in an accident.
- Apply your brakes after decelerating the vehicle speed properly using the engine brake.
- Use snow tires for safer driving when driving on a snowy or icy roads.



Warning

Driving on a sandy or muddy road

- Keep your speed as low and steady as possible.
- Accelerating or stopping suddenly while driving may cause the vehicle to be caught in the sand or mud.
- If the vehicle is caught in the sand or mud, place a stone or a wooden plate below the wheels and drive off from the sand or mud. Or, depress the accelerator pedal slowly and drive off using inertia by forwarding and reversing repeatedly.
- If you depress the accelerator pedal excessively to drive off from the sand or mud, the tires may slip, causing damage to the transmission and relevant driving systems. If possible, have your vehicle towed by another vehicle.



Warning

Driving on a hillside road and downhill road

- Downshift in accordance with the road conditions.
- If you apply the engine brake suddenly while driving on a hillside road or a downhill road, the engine may get damaged. Reduce the vehicle speed and downshift.
- Use the brake pedal and the engine brake together on a long downhill road. Applying the brake pedal continuously on a long downhill road may overheat the braking system, lowering the braking performance and resulting in an accident.



Warning

Driving on a road with a pool of water or a river

- Avoid crossing a road with a pool of water or a river if possible. If water gets into the engine or the electric systems, it may cause serious damage to your vehicle.
- If you need to cross a road with a pool of water or a river unavoidably, select a shallower part where the exhaust pipe will not be submerged under water and cross slowly at a constant speed.
- Before crossing a river, get out of the vehicle and check the bottom of the river. Do not cross through a place where the bottom is sandy or covered with big rocks.
- If several vehicles cross the river together, the path where the vehicle ahead has crossed may have caved in. Cross through a different path if possible.

Cautions for crossing

- If the engine stops while crossing a road with a pool of water or a river, do not restart, and have your vehicle towed.
- Take particular caution not to allow water to enter into the engine through the air cleaner.
- Never change gears while crossing a road with a pool of water or a river.

Checking the vehicle after crossing

- If water gets into brake-related equipment, the brake performance will be lowered. After crossing a road with a pool of water or a river, drive slowly and depress the brake pedal slightly several times. Drive normally after drying the brake discs with the frictional heat and checking the braking performance.
- Check the parts at the bottom of the vehicle where oil and fluid are injected. If you discover any problems, have your vehicle checked immediately.
- Check the lamps and other electrical devices and replace them if necessary.
- Check for any damage on the vehicle body or at the bottom of the vehicle. If you discover any problems, have your vehicle checked immediately.
- If your vehicle is heavily soiled, wash your vehicle to protect the vehicle body.



Warning

Do not use a cellular phone or watch DMB while driving

- Using your cellular phone or watching DMB while driving will distract yourself and may cause an accident. If necessary, pull over your vehicle safely to use your cellular phone.



Warning

Driving on the expressway

- Before driving, check the weather information in advance, and check the fuel level, brake system, cooling system, level of tire wear and pressure, and maintain the vehicle thoroughly.
- Drive slowly for 2km after starting if possible.
- Always observe the speed limit and do not drive too fast.
- Keep a proper safe distance from the vehicle ahead.
- In case of bad weather, maintain more than twice the safe distance from the vehicle ahead than usual and reduce the speed by more than a half.
- Do not load the vehicle with unnecessary articles.
- Check and maintain the vehicle periodically to maintain the best vehicle condition.

Crossing an intersection or railroad crossing

- When you cross an intersection or railroad crossing, stop first, check for safety, and then cross promptly using a lower gear, without shifting if possible.
- If the engine stops in the middle of an intersection or railroad crossing, move the vehicle to a safe place promptly. If necessary, ask people around for help.



Warning

No sudden maneuvering of the steering wheel

- If you maneuver the steering wheel suddenly, the driving condition of the vehicle may become unstable, causing the risk of an accident.

Do not warm up the engine or check the vehicle in a sealed space

- Do not warm up the engine or check the vehicle in an airtight or badly ventilated space. The exhaust gas from the vehicle may cause gas poisoning.

Use of the engine brake

- When driving on a long downhill road, use the engine brake and the foot brake at the same time. When you downshift according to the driving conditions, the engine brake will operate.
- Using the foot brake excessively may cause the fade or vapor lock phenomenon due to overheating of the brake system, lowering the braking performance.

What is the fade phenomenon?

The fade phenomenon is the reduction of braking force due to a decrease in the friction force caused by a temperature increase in the friction surface of brake when the brake is applied excessively on a long downhill road.

What is the vapor lock phenomenon?

The vapor lock phenomenon is the condition that when the brake is applied excessively on a downhill road, bubbles form in the brake fluid in the wheel cylinder or brake pipe of the hydraulic brake so that proper hydraulic pressure cannot be transferred, causing the brake system not to operate properly even if the pedal is depressed.



Warning

Cautions for attaching accessories

- Do not attach accessories or unnecessary articles to the vehicle windows. They may interfere with your driving, and if attached accessories act as a lens (magnifying glass), a fire or an unexpected accident may occur.

Special cautions when checking the coolant

- Never open the engine coolant reservoir cap when the engine is hot. Doing so may cause hot steam or coolant to erupt, causing burns on your body parts including the hands or face.

Do not load hazardous materials

- Do not store any flammable materials such as gasoline, butane gas, or a disposable gas lighter, or explosive materials inside the vehicle. If the indoor temperature rises, the container may burst, causing a fire.



Warning



Do not remove the coolant reservoir cap when the engine and the radiator are hot. The cooling system may spray hot coolant if the cap is removed, causing serious injuries.



Caution

Cautions for vehicle ventilation

- For a new vehicle purchased within 1 year, harmful volatile organic compounds (VOC) to human body may be emitted in the cabin. In particular, riding a vehicle exposed to direct sunlight for a long period of time or without proper ventilation may cause headache, dizziness or nausea.
- Operate the fresh air inflow mode or open the windows periodically to ventilate air inside the vehicle for the health of passengers and a pleasant vehicle environment.



Caution

System protection function (delayed accelerator pedal response)

- Do not depress the brake pedal while driving with the accelerator pedal depressed. Doing so may affect the vehicle driving system and the response from the accelerator pedal may be delayed.
- This symptom is a safety function to protect the vehicle system. This symptom will disappear if you depress and release the accelerator pedal once with the brake pedal not depressed.

Placement of extinguisher

- An extinguisher is an essential item for early extinguishing when a fire occurs. It is recommended to purchase it from a fire-fighting appliance store and place it in the vehicle.

KG Mobility Authorized Service Center and maintenance partners

KG Mobility Authorized Service Center or maintenance partners for checking and repairing the vehicle. If you use other service centers or maintenance shops, warranty repair will not be available and warranty will not be provided for any consequent problems.

Cautions for the depletion of battery when connecting uninterruptible power supply to the black box system

If the vehicle is not operated for a long period of time with the uninterruptible power supply connected to the black box system, the vehicle battery may be depleted.

Turn off the black box system if you will not drive the vehicle for a long period of time.

Long-term parking mode

This mode is for preventing vehicle battery discharge. Set it on the instrument cluster and use it if necessary.

During setup, smart key search is stopped to minimize power and some functions are limited.

Breaking in a new vehicle correctly

Break-in is not required for a new vehicle. However, the driving condition for the first 1,000 km significantly affects the life and performance of the vehicle. Pay attention to the following when driving during this period.

- Allow the engine to reach normal operating temperature before driving.
- Do not speed, accelerate, brake suddenly, or idle the engine excessively.
- Shift properly according to driving speed.
- Do not overload the engine while driving a sloping road.
- Do not tow a trailer during the first 1,000 km.
- During the first 1,000 km of towing a trailer, do not drive at a speed over 80 km/h or with full acceleration. Doing so may damage the engine or other components due to overload.
- Check the level of engine oil frequently until the first 5,000 km of operation and add oil if necessary.

Using genuine parts

Always use genuine parts for maintaining safety and the best performance of your vehicle. Warranty repair will not be provided for car trouble caused by using a non-genuine part.

You can verify a genuine part by its hologram and sticker with the product number.



- **The warranty does not cover problems caused by using non-KG Mobility genuine parts.**
- **You can distinguish an authentic KG Mobility genuine part by its hologram.**

Vehicle washing

After driving on a coastal road (salty road), a road where calcium chloride was spread, an area with excessive smoke or coal tar, or a muddy or dusty area, or when the vehicle is stained with tree sap or insects' or birds' droppings, wash the vehicle immediately since corrosion may occur on the vehicle body.

- Avoid direct sunlight and wash the vehicle in the shade. If your vehicle has been parked under direct sunlight, let it cool properly before washing.
- Dust off the vehicle with cold water.
- Mix cold water with detergent in a bucket and wipe the vehicle from top to bottom using a soft brush, sponge, or cloth.
- Wash off any foreign materials on the vehicle body without damaging the painted surface.
- Any scratched or damaged painted surface causes corrosion, so repair them with paint for repair.
- Remove moisture using a dry and soft cloth.
- After washing, drive the vehicle normally after driving it slowly, and checking the operating status of the brakes.



Caution

- Be careful not to damage the air spoiler when cleaning the vehicle in an automatic car wash.
- When you wash the bottom or exhaust pipe of the vehicle with water (including high pressure washing), be careful not to damage the sensors or connectors connected to the exhaust pipe and prevent water intrusion. Our warranty will not be provided for any consequent failure.
- Avoid washing with water when the brake discs are hot. Hot brake discs may be deformed or damaged if it comes into contact with water.
- If possible, avoid high pressure washing for maintaining and managing the vehicle performance.
- High pressure washing may damage the components and sensors installed on the exterior of the vehicle and the painted surface of the panels. In particular, be careful not to get water into the electrical devices and sensors at the bottom of the vehicle.
- When you use high pressure washing unavoidably, maintain a proper distance between the high pressure water nozzle and the vehicle. If the distance is too close, the sensors on the bumper may malfunction or the painted surface of the panels may be damaged due to the high water pressure.

- Do not use abrasive wax and strong cleaning materials such as steel wool which will scratch the vehicle body and bumper.
- Do not wash the engine compartment using liquid materials such as water or wax. If liquid materials get into the inside of the engine through the electrical devices (sensors) or air ducts located in the engine compartment, various electrical devices may malfunction or the vehicle's operation may not be possible.



Washing the bumper

- Wipe off foreign materials using a soft sponge.
- If the bumper is contaminated by engine oil or any lubricants, wash it off using soapy water.



Caution

- **Do not use abrasive wax or a brush to wipe the bumper or the vehicle body. Doing so may damage the bumper or the surface of the vehicle body (painted surface).**

Washing wheels

Clean the wheels after driving on a salty road to prevent the wheels from being corroded.



Caution

- **Do not use abrasive cleaners, polishes, solvents, wire brushes, and high speed washing brushes since they may damage the wheel surface.**
- **Using acid or alkaline detergents could damage the wheel surface (painted surface), so use neutral detergents for cleaning the wheels.**
- **Using strong cleaners may discolor the wheel surface. Make sure to use natural cleaners. A discolored wheel due to carelessness is not subject to free warranty repair.**

Cautions for polishing the vehicle

- Before waxing, remove dust or moisture from the vehicle.
- Apply a small amount of wax on a soft cloth, apply it to the whole vehicle body evenly, and scrub a wide area in the same direction to polish.
- After waxing, remove residual wax from the vehicle body completely.



Caution

- **Do not polish or wash the vehicle body using wax containing abrasives. Doing so may damage the surface of the vehicle body (painted surface).**

Cleaning and maintaining glass

- Clean the indoor and outdoor sides of glass windows using a glass cleaner and a soft cloth.
- When cleaning the glass windows, be careful not to damage the electric demister element.
- When automatic car washing is used, coating (wax) substance included in the cleaning fluids may adhere to the glass surface and it may not be wiped off easily when it is dried. Spray washer fluid and operate the wipers two or three times to remove coating (wax) substances using the cleaning substances included in the washer fluid.
- Do not wipe the glass surface with a towel stained with oil or wax. Doing so may cause vibrations and abnormal sounds when the wipers are operating and the front and rear windshields may not be cleaned properly when it rains. Also, the reflection of light may occur at night, causing poor visibility and affecting safe driving.

Cautions for window tinting

- All vehicles from our factory have tinted windshields and rear windows that meet the specified percentage of visible light transmission (VLT). Do not tint the windows of the product. Doing so will lower VLT, becoming subject to legal regulation.
- Tinting the windshield and rear window excessively may reduce front and rear visibility at night or in case of rain, causing an unexpected risk.
- When tinting the windshield and rear window, do not allow working solutions to enter into electrical and electronic devices. Failure to do so may cause a malfunction or failure of electrical and electronic devices.
- If the windshield and rear window are modified or tinted arbitrarily, the electric demister element may be damaged by a knife or a tool or an electrical shock.
- If the windshield and rear window are coated or tinted (metallic tinting film), the Hi-Pass system, rain sensor, and radio may not operate normally.
- Do not tint the front camera sensing part. Otherwise, the relevant system may malfunction.

Care and cleaning of the interior

- Use a dry towel for normal cleaning.
- For synthetic resin such as plastic, clean it with lukewarm water and soap and wipe off with a wet towel with no soap.
- Wipe using a dry towel to dry.
- Remove dust on the seats and mats using a vacuum cleaner.
- If the mats are heavily stained, spray a cleanser on them and wipe using a cloth.



Warning

- **To prevent from burning and electric shock, turn off the interior lights before cleaning the vehicle interior.**



Caution

- **When you use chemicals for cleaning the interior, the color or shape of the interior may change.**
- **Do not use chemical products such as acetone, enamel, and bleach for cleaning the interior.**
- **The Leather Seat Maintenance is necessary on Quarter basis with dedicated Leather Milk or Cream in order to feed the Leather and avoid any cracks on the seats and conserving the original look and comfort of the seat.**

Seat Belt Care

- Keep belts clean and dry.
- Clean seat belts only with mild soap and lukewarm water.
- Do not bleach or dye belts since this may severely weaken them.

Cautions for using the vehicle key

- Be careful not to lose your key.
- If your key is lost or stolen, replace the whole key set to prevent the vehicle from theft.
- Do not throw or drop your key. Doing so will damage your key. Do not drop your key in water.
- Use only the same standard battery for the key and be careful not to switch the polarity when inserting the battery.

Corrosion protection

Your car was designed to resist corrosion. When it was built, special and protective finishes were used on most parts of your car to help maintain a good appearance, strength and reliable operation. Some parts which normally are not visible (such as certain parts located in the engine compartment and the underbody of the vehicle) are such that surface rust will not affect their reliability. Therefore, corrosion protection is not needed or used on these parts.

Sheet Metal Damage

If your car is damaged and requires body panel repair or replacement, make sure the body repair shop applies proper anticorrosion material to the parts repaired or replaced so that corrosion protection is restored. (Also refer to “Finish Damage” on the next page).

Foreign Material Deposits

Calcium chloride and other salts, deicing agents, road oil and tar, tree sap, bird droppings, chemicals from industrial chimneys and other foreign materials may damage vehicle finishes if left on painted surface. Prompt washing may not completely remove all of these deposits. Other cleaners may be needed. When using chemical cleaners, be sure they are safe for use on painted surfaces.

Finish Damage

Any stone chips, fractures or deep scratches in the finish should be repaired promptly. Bare metal will corrode quickly and may develop into a major repair expense. Minor chips and scratches can be repaired with touch-up materials. Larger areas of finish damage can be corrected in your Distributor's body and paint shop.

Underbody Maintenance

Corrosive materials used for ice and snow removal and dust control can accumulate on the underbody. If these materials are not removed, accelerated corrosion (rust) can occur on underbody parts such as the fuel lines, frame, floor pan, and the exhaust system even though they have been provided with corrosion protection. At least every spring, flush these materials from the underbody with plain water. Take care to clean any area where mud and other debris can accumulate.

Sediment packed in closed areas of the frame should be loosened before being flushed. If desired, your KG Mobility Distributor can do this service for you.



Caution

- When the engine is washed, fuel, grease or oil residues are washed off. Therefore you should use only a filling station or a KG Mobility Distributor who has oil separator equipment in the car wash bay.
- Used engine oil, brake fluid, transmission fluid, antifreeze, batteries, and tires should be disposed by using the local authorized waste disposal facilities, or have them disposed of by the vendor who is under a statutory obligation to do so when you replace them.
- None of these items should be placed in the household recycling bins or poured into the sewage system.
- Everyone should be concerned about environmental protection.
- Help by doing your share.
- When a strong multi-purpose, acid, or alkaline detergent is used to clean up the surface of the painted body, side mirrors, windshield, plastic moldings or leather, changes, fading of colors or rusting can happen.

- When the windshield is cleaned with an oil-contained or waxed towel, strange sounds and vibrations may occur on the windshield surface when the wipers are operating. Also, decreased visibility, reflection at night, or poor removal of water on the windshield may happen. Do not clean the windshield with an oil-contained or waxed towel.
- An abrasive detergent may damage the painted surface of your vehicle, including the bumper. Do not buff or polish your vehicle with an abrasive detergent.
- An acid or alkaline detergent may damage the painted surface of the aluminum or alloyed wheels.
- When chemical products are used to clean up the interior, the chemical products may change some colors or distort the shape of some interior parts.
- When cleaning up interior parts, do not use chemical products such as acetone, enamel or bleach.

System safety mode

The protective measures including illumination of engine warning lamp and reduced engine power are taken (engine turned off in worst case) when there is a critical fault in the system or a malfunction in the major electrical or fuel system. This indicates the system entering the safety mode to protect the vehicle's drive system.



Danger

- If the safety mode is activated, pull over and stop the vehicle to a safe location immediately and contact your KG Mobility Dealer. Then drive slowly or have the vehicle towed to a KG Mobility Dealer or KG Mobility Authorized Service Center according to the dealer's instruction and have your vehicle checked by a mechanic.
- If you continue to drive in this state, normal driving is not maintained due to the fixed engine rpm and engine can stop. But even more importantly, continued driving with this state may damage the drive system.

Vehicle Fueling from Drums or Storage Containers

For safety reasons (particularly when using noncommercial fueling systems) fuel containers, pumps and hoses must be properly earthed.

Static electricity build up can occur under certain atmospheric and fuel flow conditions if unearthed hoses, particularly plastic, are fitted to the fuel dispensing pump.

It is therefore recommended that earthed pumps with integrally earthed hoses be used, and that storage containers be properly earthed during all noncommercial fueling operations.

Fuel recommendation

Commercially available high-quality fuels are suitable. Fuel quality has a decisive influence on the power output, driveability and life of the engine. The additives contained in the fuel play an important role in this connection. You should therefore use only high-quality fuels.

Gasoline Engine

Fuel with too low an octane number can cause pre-ignition (detonation). KG Mobility can not be held liable for resultant damage.

Fuel Recommendation

Type	Unleaded gasoline (Octane number 95 or higher)
------	---



Caution

- For correct octane rating setting and other use of gasoline (ex. Leaded), consult your KG Mobility Dealer.

 **Caution**

Engine and exhaust system will be damaged.

- **Do not use leaded fuel to the vehicle for unleaded fuel.**
- **Use the fuel with specified or higher Research Octane Number recommended for your country by KG Mobility. It is not covered by warranty.**

Do not Use Methanol

Fuel containing methanol (wood alcohol) which is not qualified EN228 and EN590 standards should not be used in your TORRES. This type of fuel can reduce vehicle performance and damage components of the fuel system.

The warranty policy will not cover damage of the fuel system and any performance problems that are caused by the use of methanol or fuel containing methanol.

Engine check indicator

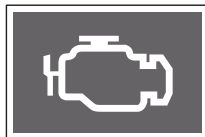

The engine check indicator on the instrument cluster turns on when the fuel system of the engine or main electrical systems are not working properly. At this time, the driving power of the engine may decrease or the engine may turn off.

If it occurs, have your vehicle checked and maintained by our service center.

Other maintenance

After driving on a calcium chloride (salt) sprayed road, wash the bottom of your vehicle as soon as possible to avoid any rust.

When parking on a snow-covered road, the brake system may begin to have some ice on it. The ice will decrease your vehicle's braking ability. If this happens, drive at a low speed and use the brake frequently to remove the ice. After regaining the braking ability, drive your vehicle at a normal speed.

 **Warning**

- **When there is ice on the wiper blades, turning on the wiper switch may put an extra burden on the wiper motor and damage it. Avoid using the wipers when ice is on the blades.**
- **When driving on a snow-covered road, a large amount of snow may build up under each wheelhouse. This buildup prevents the steering wheel from moving freely. Therefore, remove the snow buildup frequently.**

2. Safety Units

You can check information regarding units that allow you to drive the vehicle safely and how to use such devices.

An explanation is provided for seat belts, a child restraint for an infant or a small child, airbags, anti-theft and warning system.

Seat belt

The seat belt is the most fundamental safety unit that protects an occupant and prevents or reduces injury when an accident occurs.

If you do not fasten the seat belt or fasten the seat belt incorrectly, the seat belt does not function properly and you may also get injured by the seat belt.



Warning

- **All occupants must fasten their seat belt before driving. Failure to do so may lead to a fatal accident, in case of emergency or when the brake is applied suddenly.**
- **The air bag can ensure the safety only when the seat belt is fastened correctly. If the air bag inflates when you do not fasten the seat belt or fasten it incorrectly, you may get injured by the inflated air bag.**

Seat belt warning

If the occupants in the driver seat and the front passenger seat do not fasten their seat belts, the warning lamp on the instrument cluster blinks along with a warning buzzer.

The rear seat (left, center and right) reminder illuminates the warning lamp or sounds the buzzer depending on the vehicle conditions and whether the seat is occupied or not.

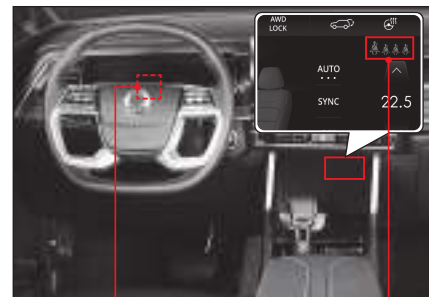

- 1 Warning lamp for driver and front passenger
- 2 Front passenger warning lamp
- 3 Rear (left) seat warning lamp
- 4 Rear (center) seat warning lamp
- 5 Rear (right) seat warning lamp

Front seat (driver / passenger) belt reminder

- The seat belt reminder warning lamp and buzzer are triggered only when the ignition switch is turned on or the engine is started.
- If you turn the ignition switch on or start the engine with the seat belt not fastened, the warning buzzer sounds and warning lamp flashes for about 6 seconds. At this time, when the seat belt is fastened, the warning buzzer stops and the warning lamp flashes for the rest of the time.
- If you turn the ignition switch on or start the engine with the seat belt fastened, only the warning lamp flashes for about 6 seconds.
- If you fasten and then unfasten the driver seat belt, the warning buzzer sounds while the warning lamp flashes for about 6 seconds. However, for the passenger seat, the warning lamp and buzzer do not work even if the seat belt is fastened and then unfastened.
- When driving the vehicle at a speed of about 10 km/h or higher with the seat belt not fastened, the warning lamp comes on for about 100 seconds and the warning buzzer sounds. After 100 seconds, the warning buzzer stops and only the warning lamp stays on.

Front seat (passenger) belt reminder

- The seat belt reminder warning lamp and buzzer are triggered only when the ignition switch is turned on or the engine is started and a front passenger is detected.
- The seat belt reminder is issued at the same time by the instrument cluster and the buttonless integrated control panel.
- If you turn the ignition switch on or start the engine with any front passenger not seated, only the warning lamp flashes for about 6 seconds.
- If you turn the ignition switch on or start the engine without fastening the passenger's seat belt while the system detects that the front passenger seat is occupied, the warning buzzer sounds and warning lamp flashes for about 6 seconds. At this time, when the front passenger seat is detected as unoccupied or the front passenger seat belt is fastened, the warning lamp flashes for the rest of the time.
- If the seat belt is not fastened after 6 seconds, the seat belt reminder will activate and the warning lamp will flash. At this time, when the front passenger seat is detected as unoccupied or the front passenger seat belt is fastened, the warning lamp will go out immediately.
- When a front passenger is detected with the ignition switch in the ON position, the seat belt reminder is activated.

Rear seat (left / center / right) belt reminder*

- The rear seat belt reminder warning lamp comes on for 70 seconds when the ignition switch is turned on regardless of whether the seats are occupied or not and the warning buzzer does not sound.
- The rear seat occupancy sensor recognizes that the corresponding (left, center and right) seat is occupied when the rear seat belt is fastened and then unfastened with the ignition switch turned on.
- If the seat belt is fastened when the warning lamp comes on for 70 seconds by turning the ignition key on the corresponding warning lamp goes off.
- If the rear seat belt is fastened and then unfastened at a vehicle speed of 10 km/h or less, the corresponding warning lamp stays on until the seat belt is fastened. At this time, the warning buzzer does not sound.
- If the rear seat belt is fastened and then unfastened at a vehicle speed of 10 km/h or higher, the corresponding warning lamp keeps flashing until the seat belt is fastened and the warning buzzer sounds for 70 seconds.
- The rear seat occupancy is reset when: the rear door is open and closed with the vehicle stationary (speed of 0 km/h) and ignition switch turned on.



Caution

- The passenger seat belt warning operates only when an occupant on the front passenger seat is detected. When the occupant on the front passenger seat is positioned inappropriately or is too small, the occupant may not be detected.
- When an object is placed on the front passenger seat, the occupant detection sensor may operate and the passenger seat belt warning may operate.
- If the warning lamp or the warning buzzer persists after fastening the seat belt, have your vehicle checked and serviced at a KG Mobility Corporation Authorized Service Center.

Notice

- Seat belt warning may persist until the seat belt is fastened depending on the vehicle condition.
- When the gear shift lever is maintained at the R (reverse) position for 1.5 seconds or longer, the seat belt warning (reminder) does not operate.
- If the vehicle speed falls below about 10 km/h while the seat belt reminder is in operation, the seat belt reminder is deactivated and a seat belt warning is activated.

Fastening the seat belt

- 1 Sit upright on the seat with the hip against the seat cushion.
- 2 Hold the seat belt latch and pull it slowly in the direction of the buckle.

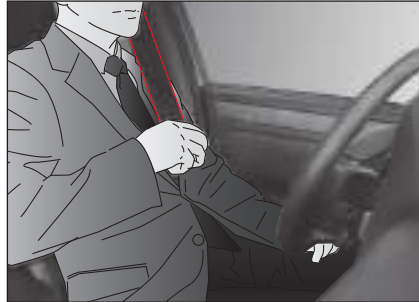

Warning

- Wear the seat belt in a way that it is not twisted. If the seat belt is twisted, it cannot distribute the impact at the time of an accident properly.

Notice

- If the seat belt is locked and does not move, loosen the seat belt a little bit and pull it slowly or strongly. In some cases, you have to pull the seat belt strongly for approximately 2 to 3 seconds to move it.

- 3 With the shoulder belt webbing positioned across the chest and the lap belt webbing positioned across the hips, insert the belt latch into the buckle until it clicks.

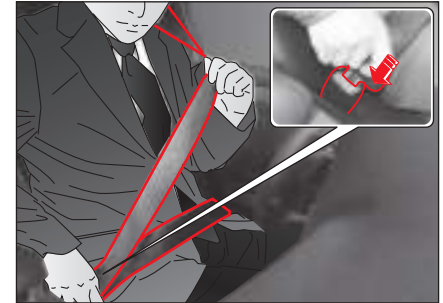

Warning

- Fasten the seat belt in a way that the shoulder belt webbing is positioned across the chest. If the shoulder belt webbing is positioned across the neck, a serious injury may occur by the belt in the event of an accident.
- Position the lap belt webbing as low as possible across the abdominal area. If the lap belt webbing is positioned across the abdominal area, an impact may happen in the event of an accident, resulting in a serious injury.
- Pull the belt latch to make sure that it is securely locked into the buckle.

- 4 Adjust the height of the shoulder belt webbing using the seat belt height adjuster if needed.
- 5 Adjust the belt webbing on the chest and the hips to not be slack.



! Warning

- Do not fasten the seat belt higher than the body or loosely. Doing so may cause the body to slip below the seat belt in the event of a collision accident, resulting in injury.

Unfastening the seat belt

- 1 To unfasten the seat belt, press the red button on the buckle and separate the belt latch from the buckle.



- 2 Hold the belt latch and let the seat belt webbing to be wound slowly.

Managing the seat belt

Adjusting the height of the front seat belt

You can adjust the height of the shoulder belt anchorage to prevent the seat belt from being positioned across the neck.

! Warning

- Adjust the height of the seat belt before driving.

- 1 With the top of the seat belt height adjuster pressed, raise or lower the seat belt holder.



- 2 Release it at the desired position. The seat belt holder is secured.

Rear seat belt storage

If you do not use the rear seat belts or wish to fold the rear seat back, insert the seat belt into the webbing guide installed on the wall as shown in the figure.



Caution

- Remove from the webbing guide first if you wish to use the seat belt. Pulling the seat belt with the webbing guide inserted may damage the webbing guide or the seat belt.

Rear seat buckle storage

If you do not use the rear seat belts, insert the buckle into the buckle storage as shown in the figure.



Rear center seat belt storage

Have the auxiliary latch inserted into the auxiliary buckle always if you do not use the rear center seat belt.

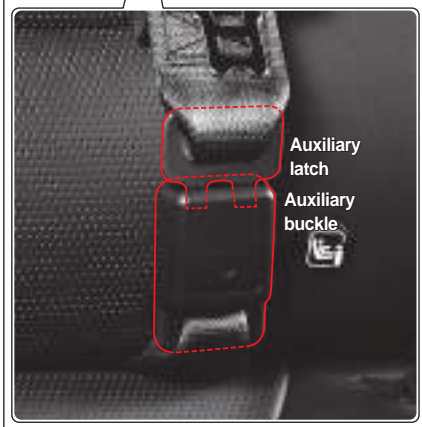

Rear center seat belt release

- 1 Press the auxiliary buckle hole (1) using the emergency key.



- 2 Hold the auxiliary latch (2) and left the seat belt to be wound slowly.

Warning

- If the auxiliary latch retracts at high speed, an adjacent occupant may get injured.
- Do not allow a child to pull and release the auxiliary latch repeatedly.

How to fasten the seat belts (2-point) in rear center seat

- 1 Pull out the latch plate at the bight of the seat.

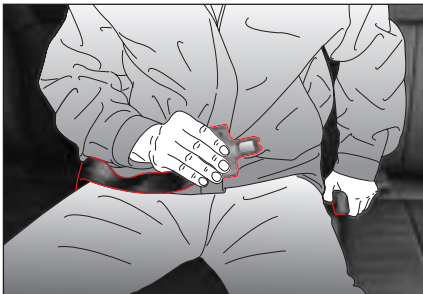

Warning

- Put the lap belt as low as possible across the hips. Do not put it across waist. In an accident, the belt may apply pressure to your abdomen. This may cause serious internal injuries.

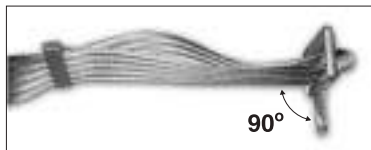

To lengthen, hold the metal latch plate at a right angle to the belt and pull the belt. To shorten, pull the free end of the belt away from the latch plate, then pull the belt clip to take up the slack.

- 2 Insert the metal latch plate into the buckle until it clicks. Position the belt as low as possible across your hips, not across your abdomen.

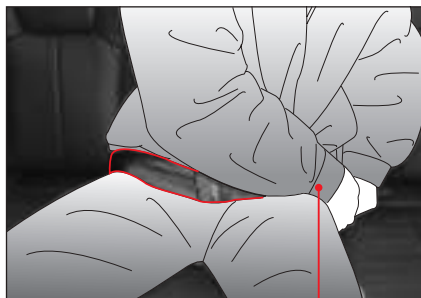

- 3 If the belt is too tight or slack on your hips, readjust the belt.
- 4 To unfasten the seat belt, press the red button on the buckle.

How to fasten the seat belt (3-point) in rear center seat

- 1 Pull out the latch plate from the retractor. If the seat belt is locked when being pulled out, rewind it completely in the retractor, then pull it out to the desired length.



- 2 Insert the latch plate into the right mini buckle until it clicks.

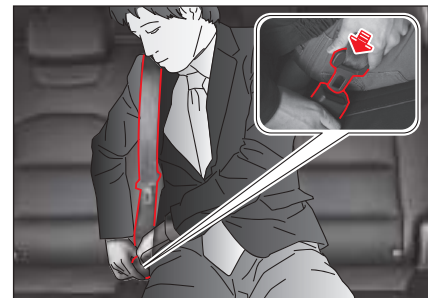

- 3 Position the shoulder belt across the body and the lap belt as low as possible across the hips. Insert the latch plate into the buckle until it clicks.
- 4 Pull the latch plate to make sure it is securely locked. A slack belt will greatly reduce the protection afforded to the wearer.
- 5 To unfasten the seat belt, press the red button on the buckle.

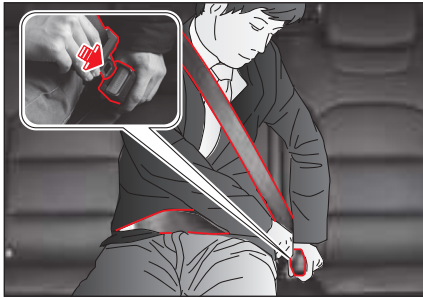

Warning

- Make sure to fasten the seat belt according to the order as described so that it functions properly.
- To prevent the seat belt from bumping against the rear glass, unfasten the seat belt while holding it.
- This seat belt is designed only for a passenger who sits on the center seat in the rear seat.
- Tug on the seat belt to make sure that the latch plate is securely locked.
- Make sure that the seat belt is not twisted.
- Improper wearing of seat belts increases the chance of injury or death in case of a collision.
- Position the seat belt away from your neck and abdomen.

Caution

- Stow the seat belt into the console when it is not in use.

Seat belt pretensioner and load limiter

The seat belt pretensioner and the load limiter are the units that operate at the same time when the driver and front passenger air bags operate, increasing the safety effect of the seat belt and the air bag.

Pretensioner

The seat belt pretensioner is a protection unit that draws back the seat belt on the occupant's chest and hips instantaneously and secures the occupant to the seat to prevent the occupant from bouncing forward in the event of a strong front collision.

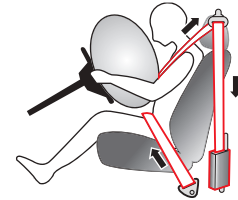

Danger

- The seat belt pretensioner is designed to operate only once. After it operates, replace the seat belt.

Load limiter

The seat belt load limiter is a protection unit that releases the seat belt right after a vehicle collision to prevent a secondary injury due to belt force.

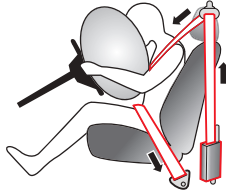

Fastening the seat belt by a pregnant woman

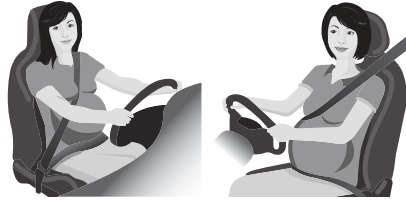

Warning

- It is dangerous for a pregnant woman to drive, so please avoid it if possible. If it is unavoidable, consult a doctor about the precautions and fastening the seat belt during pregnancy.
- Fasten the seat belt before driving. If an accident occurs without fastening the seat belt, may be dangerous for both the pregnant woman and the fetus.
- When a pregnant woman fastens the seat belt, make sure that the belt is not positioned across her abdomen. If the belt presses her abdomen, in the event of a vehicle collision or when applying a sudden brake, may be dangerous for both the pregnant woman and the fetus.

Warnings for the seat belt

Warning

Infants, small children, pregnant women or patients

- The child restraint should be used for an infant or a small child. In particular, please note that the three-point seat belt is designed for a person who is taller than 140 cm.
- In the event of a sudden stop or an accident while a pregnant woman or a patient is wearing the seat belt, strong force may apply to the abdomen or other body parts. Make sure to consult a doctor before fastening the seat belt.

Position and method to fasten the seat belt

- The seat belt is designed for only one person. Two or more persons should not share one belt.
- If the position of the seats is incorrect, it is impossible to fasten the seat belt correctly. Always adjust the position of the seats to their normal status for driving.
- Fasten the seat belt after keeping the seat upright and leaning the back against the seat backrest with the hip against the seat cushion. If the seat belt is positioned too high or fastened too loose, the body may fall out from the shoulder belt webbing or the lap belt webbing, resulting in a serious injury or death.

- If a strong impact occurs while the seat belt is fastened with the seat backrest reclined too much, the body may fall out below the belt, causing the belt to hang around the neck and result in a serious injury.
- If the seat belt is positioned across the neck, a serious injury may occur by the seat belt when an accident occurs. Make sure to wear the three-point seat belt in a way that the belt webbings are positioned across the chest and the hips.
- Do not pull your arm over the shoulder belt. Doing so prevents the seat belt from effectively blocking the body from bouncing forward in the event of a collision. A head or neck injury may occur accordingly and the impact is applied to the ribs that are weaker than the shoulder bone, causing a serious injury.
- When the shoulder belt webbing is positioned across the abdomen, the body may fall out below the belt or a great impact may be applied to the abdomen, causing a serious injury such as intestinal rupture.
- If the belt latch is inserted into another buckle that is not the relevant buckle, the safety belt may not fit the body correctly so that it cannot protect the body properly.
- In addition, if the lap belt webbing of the two-point seat belt is too loose or the seat belt is fastened incorrectly, just as fastening a twisted seat belt, a fatal injury may occur in the event of an accident.

No modification of the seat belt and no attachment of illegal fixtures

- A modified seat belt cannot guarantee safety. Never modify the seat belt.
- Inappropriate work on safety units may adversely affect or hinder the operation of the units. Be sure to have the safety units serviced at a KG Mobility Corporation Authorized Service Center that possess the required expertise, knowledge and special tools.
- If you attach an auxiliary device or accessory to the seat belt separately, the seat belt may not operate normally. Never attach any auxiliary device or accessory to the seat belt.
- Do not loosen the seat belt by locking it with a clip or a clamp. Doing so may cause a fatal injury due to a secondary impact in the event of a collision.

Checking and managing the seat belt and the importance of safe driving

- Do not allow foreign materials to enter into the seat belt buckle.
- If the seat belt and the relevant components are damaged, the seat belt may not operate normally. Check the seat belt frequently for any damage and the status of normal operation, and if any abnormality is discovered, have the seat belt repaired at a KG Mobility Corporation Authorized Service Center immediately.

- If a strong impact has been applied to the seat belt due to an accident, etc., make sure to have the seat belt checked and replaced with a new one as needed even if there is no abnormality visually. Also check and replace the retractor and the seat belt anchorage if there is an abnormality.
- Care should be taken to prevent the seat belt from being contaminated by polishes, oils, chemicals and especially battery acid. When cleaning, wipe the seat belt carefully using a neutral detergent and water. Replace the seat belt if the webbing is frayed, contaminated or damaged.
- Do not place a hard or sharp object in the clothes or a pocket where comes into contact with the seat belt.
- The seat belt can reduce serious injuries. However, it cannot block fatal accidents and injuries completely. Keep this in mind and drive safely.

Child restraint for an infant or a small child

For an infant or a small child who cannot wear the three-point seat belt, have the infant or the small child be seated in a rear seat using a child restraint for an infant or a small child whose quality is certified by the government.

If the infant or the small child sits in the front passenger seat, the infant or the small child cannot be protected from an inflated air bag or other impacts in the event of a vehicle collision.



Warning

Seating an infant or a small child

- Do not let an infant or a small child sit in the front passenger seat. Doing so may cause a serious injury or death due to the inflation impact of the front air bag in the event of a collision accident.
- Do not ride with an infant or a small child in your arms or sitting on your lap. Doing so may cause a fatal injury to the infant or the small child in the event of a collision accident.
- If an occupant who is smaller than 140 cm wears the three-point seat belt, the seat belt cannot function fully. In such case, install and use a child restraint that fits the physical condition of the occupant.

Installing the child restraint

- Never use a rearward facing child restraint on a seat Protected by an ACTIVE AIRBAG in front of it, DEATH or SERIOUS INJURY to the CHILD can occur.
- Use a child restraint for an infant or a small child that passed through the certification and the safety inspection carried out by a certified government agency. Follow the manufacturer's owner's manuals for the installation and precautions of the child restraint.
- If the child restraint for an infant or a small child is installed incorrectly, it may not provide the appropriate protection function. In such case, it may result in a serious risk when an accident occurs.
- If the child restraint for an infant or a small child is not secured completely, injury or death of an infant or a small child may occur in the event of a collision accident.
- Never install a rear-facing child restraint in the front seat with front passenger air bag.
- Install the child restraint for an infant or a small child on the left or right side of the rear seat where the three-point seat belt is installed. If it is installed on the front passenger seat, a fatal injury may occur when the air bag inflates.
- When installing the child restraint for an infant or a small child in the rear seat of a vehicle where a curtain air bag is installed, install it as far as possible from the door. Failure to do so may cause serious injury or death of an infant or a small child when the curtain air bag inflates.
- When the child restraint for an infant or a small child is installed on the rear seat where the three-point seat belt is installed, be careful not to position the seat belt across the neck or face of an infant or a small child.

Using the child restraint

- When the child restraint for an infant or a small child is used, observe instructions provided by the manufacturer. Failure to do so may cause a fatal injury when an accident occurs.
- After installing the child restraint for an infant or a small child, make sure to check if it is secured correctly.
- Make sure that the child restraint is secured correctly by pushing or pulling it in various directions before letting an infant or a small child sit in the child restraint.

Managing the child restraint

- Do not carry the child restraint for an infant or a small child in the vehicle without installing or securing it. Doing so may cause the child restraint to bounce, causing an injury to the occupants in the event of sudden braking or an accident.



Caution

- This information is to help in understanding the necessity and usage of the child restraint for an infant or a small child. Use this information for reference purposes.
- When the child restraint for an infant or a small child is used, install and use it according to the owner's manual provided by the manufacturer.

Infant and child safety

Child Seat

Children that are too small to use the seat belts must be properly secured in a child restraint system.

Warning

- Never install a rear-facing child restraint in the front passenger seat with front passenger air bag.
- Because of the danger that an inflating passenger air bag could impact the rear-facing child restraint and kill the child.
- Use only the qualified child restraint systems. Follow the manufacturer's instructions for installation and use of the child restraint systems.
- Do not carry your child on your lap while driving. You cannot resist against the impact pressure in an accident. The child could be crushed between you and the parts of vehicle.
- Remember that a child restraint seat left in a concealed vehicle can cause it to be very hot. Check the seating surface before putting your child in the child restraint.
- When your child restraint is not in use, remove it from the vehicle or keep it secured with a seat belt to prevent it from being thrown forward in case of a sudden stop or an accident.
- When installing a child restraint, do not let the seat belts come across the child's neck.

Table of Vehicle Handbook Information on Child Restraint Systems Installation Suitability for Various Seating Positions



Rear-facing child seat



Forward-facing child seat



TYPE A



TYPE B

Booster seat

Mass group	Restraint device figure	Front Passenger		Rear Centre ^{*1)}	Rear Out Board
		Air bag off	Air bag on		
O ~ up to 10 kg (0 ~ 9 month)	Rear facing child seat	U	X	U	U
O+ ~ up to 13 kg (0 ~ 2 year)	Rear facing child seat	U	X	U	U
I ~ 9 to 18 kg (9 month ~ 4 year)	Rear facing / Forward facing child seat	U	X	U	U
II ~ 15 to 25 kg (4 year ~ 6 years)	Booster seat	U	U	U	U
III ~ 22 to 36 kg (6 year ~ 12 years)	Booster seat	U	U	U	U

※ Child restraint system are classified into the 5 groups according to the ECE R44

*1) Do not install a CRS with support leg in this seating position

NOTE:

U: Suitable for "universal" category restraints approved for use in the mass group.

UF: Suitable for forward-facing "universal" category restraints approved for use in the mass group.

L: Suitable for particular child restraints given on attached list. These restraints may be of the "semi-universal" categories.

X: Seat position not suitable for children in the mass group.

Table of Vehicle Handbook Information on ISOFIX Child Restraint Systems Installation Suitability for Various ISOFIX Positions

Mass group	Size Class	Fixture	Vehicle ISOFIX Positions		
			Frnt Passenger	Rear Centre	Rear Out Board
CARRYCOT	F (1)	ISO/L1	X	X	X
	G (1)	ISO/L2	X	X	X
GROUP 0 UP TO 10KG	E (2)	ISO/R1	X	X	IL
GROUP 0+ UP TO 13KG	E (2)	ISO/R1	X	X	IL
	D (2)	ISO/R2	X	X	IL
	C (2)	ISO/R3	X	X	IL
GROUP I 9 TO 18KG	D (2)	ISO/R2	X	X	IL
	C (2)	ISO/R3	X	X	IL
	B (3)	ISO/F2	X	X	IUF/IL
	B1 (3)	ISO/F2X	X	X	IUF/IL
	A (3)	ISO/F3	X	X	IUF/IL

NOTE: Key of letters be inserted in the above table

IUF: Suitable for ISOFIX forward child restraints systems of universal category approved for use in this mass group.

IL: Suitable for particular ISOFIX child restraint systems (CRS) given in attached list. These ISOFIX CRS are those of the “specific vehicle”, “restricted” or “semi-universal” categories.

X: ISOFIX position not suitable ISOFIX child restraint systems in this mass group and/or this size class.

- (1) Some child seats are installed transversely and occupy two seats. Make sure that the feet of child are facing the door.
- (2) Slide the front seat forward all the way to install the rear-facing child restraint. Then, slide the front seat back as directed in the manual provided with the child restraint.
- (3) When using a forward-facing child restraint, do not slide the front seat backwards more than halfway for child's safety. In addition, do not tilt the front seat backrest backwards too far (max. 25°) and raise it as high as possible.

Table of Vehicle Handbook Information for Installation in Various Seating Positions on i-Size Child Restraint Systems

Seating Posion	i-Size Child Restraint Systems
Front Passenger Outboard	X
Rear Outboard Left	i-U
Rear Outboard Right	i-U
Rear Center	X

Key of letters to be inserted in the above table:

i-U: Suitable for i-Size "universal" Child Restraint Systems forward and rearward facing. (valid position for forward facing and rearward facing child restrant systems approved under ECE R129)

i-UF: Suitable for forward-facing i-Size "universal" Child Restraint Systems only.

X: Seating position not suitable for i-Size "universal" Child Restraint Systems.(invalid position for child restrant systems approved under ECE R129)

List of suitable universal Child Restraint Systems (CRS)

Please read carefully the installation manual of your child restraint

Mass group	Child Restraint	Features
0	< 10 kg	-
0+	< 13 kg	Maxi Cosi CabrioFix
I	9 to 18 kg	Römer King II LS
II	15 to 25 kg	Römer KidFIX II XP SICT
III	22 to 36 kg	Römer KidFIX II XP SICT
		Peg-Perego Viaggio 2~3 shuttle

List of suitable ISOFIX Child Restraint Systems (CRS)

Please read carefully the installation manual of your child restraint

Mass group	Child Restraint	Features
0	< 10 kg	-
0+	< 13 kg	Maxi Cosi CabrioFix & FamilyFix
I	9 to 18 kg	Römer Duo+
II	15 to 25 kg	Römer KidFIX II XP SICT
III	22 to 36 kg	Römer KidFIX II XP SICT
		Peg-Perego Viaggio 2~3 shuttle

List of suitable i-Size Child Restraint Systems (CRS)

Please read carefully the installation manual of your child restraint

Mass group	Child Restraint	Features
67 cm - 105 cm ≤ 18.5 kg	Maxi Cosi 2way Pearl & 2wayFix	ISOFIX & Support Leg Rearward facing
> 15 months 105 cm ≤ 18.5 kg		ISOFIX & Support Leg Forward facing
100 cm - 135 cm	Besafe iZi Flex FIX i-size	ISOFIX & Support Leg (without side bumpers)

Installation of crs secured by the seatbelt

Front-facing Child Seat



Secure the child restraint with a seat belt as shown in the figure.

Caution

- When installing a child restraint system, follow the instructions provided by the manufacturer.

Warning

Do not use the car seat unless the followings are met.
The child seat may not perform as intended, which may result in a serious injury.

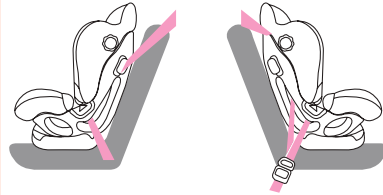

- Make sure that the buckle of the seat belt is securely engaged.
- Make sure that the seat belt is not loose or twisted.
- Make sure that the base does not move due to excessive play in all directions.
- You can't adjust the angle of the backrest with the child seat installed. If you're trying to do so, the seat belt will be slack, which incurs danger. Always adjust the angle of the backrest before installing the child seat.

Rear-facing Child Seat

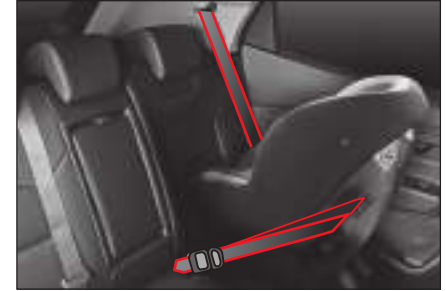

Secure the child restraint with a seat belt as shown in the figure.

Caution

- Never install a rear facing child restraint on the front seat without ensuring that the front airbag is deactivated. KG Mobility Corporation recommends that a child restraint to be installed on the rear seat.

When installing a child restraint, adjust the seat back angle as desired.



Warning

Do not use the child seat unless the followings are met.

The child seat may not perform as intended, which may result in a serious injury.

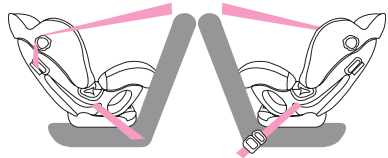

- Make sure that the buckle of the seat belt is securely engaged.
- Make sure that the seat belt is not loose or twisted.
- Check if the angle of the backrest is set to 4 stage.
- Make sure that the base does not move due to excessive play in all directions.
- Make sure that the seat belt is routed through the rear-facing belt path and buckled up.

Securing a child restraint system with “ISOFIX/i-Size” system and “Tether Anchorage” system*

ISOFIX/i-Size system is a standardised method of fitting child seats that eliminates the need to use the standard adult seatbelt to secure the seat in the vehicle.

This enables a much more secure and positive location with the added benefit of easier and quicker installation. An ISOFIX/i-Size-seat can only be installed if it has approval in accordance with the requirements of ECE R44 or ECE R129.

Locations of ISOFIX/i-Size Lower Anchors and Top Tether



- 1 Two ISOFIX/i-Size lower anchors are installed at the bottom of the seatback at each outboard seat as shown in the figure.
- 2 The ISOFIX/i-Size lower anchors can be identified by the symbol attached on the top surface.



- 3 Two (for EURO countries) or three (Australia) ISOFIX/i-Size top tethers are installed at the upper side of seatback.

How to use ISOFIX/i-Size Lower Anchor

The ISOFIX/i-Size lower anchor is exposed when you widen the space between seatback and cushion.



- 1 Now, you can see the ISOFIX/i-Size lower anchors.

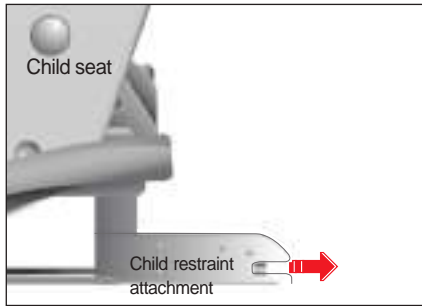

- 2 Insert the child restraint attachments into the ISOFIX/i-Size lower anchors until it clicks.
- 3 Adjust the seatback angle as desired.

Warning

- When using the ISOFIX/i-Size lower anchor, make sure that no interference are around the bar and the seat belt is not stuck.
- Rock the child restraint to check if it is securely installed. Refer to instructions provided by the manufacturer of the child restraint.
- Do not install the child restraint if it hinders the operations of front seat.

How to use Top Tether

- 1 Adjust the seatback angle as desired.



- 2 Connect the top tether connector in child restraint to the top tether on the seatback of the second row seat.
- 3 Securely tighten the child restraint by adjusting the webbing of top tether connector.

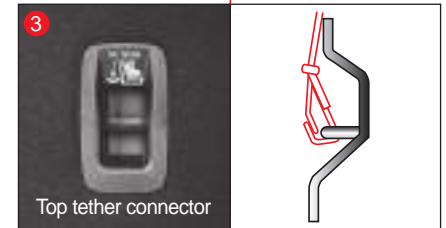

Warning For Child Restraint

- **Use only the officially approved child restraint.**
KG Mobility is not responsible for the personal injury and property damage due to the defect of child restraint.
- **These seats are subject to the ECE R44 or ECE R129 standard.**
- **Use only the child restraint with proper type and size for your baby.**
- **Use only the child restraint at proper location.**
- **Child restraint has 5 categories based on the weight as below according to ECE R44.:**
GROUP 0: 0 ~ 10KG
GROUP 0+: 0 ~ 13KG
GROUP I: 9 ~ 18KG
GROUP II: 15 ~ 25KG
GROUP III: 22 ~ 36KG
- **Group 0 & 0+**
Rear facing child restraint fitted on the rear seat
- **Group I**
Rear facing or forward facing child restraint fitted on the rear seat
- **Group II & III**
Booster seat fitted on the rear seat with seat belt fastened

Always follow the installation and use instructions provided by the manufacturer of the booster seat.

- **i-Size:** child seats with i-Size approval must meet the requirements prescribed in the ECE R129 standard in relation to installation and safety. Child seat manufacturers can tell you which seats have i-Size approval for this vehicle.



Caution

- Top tether is the supplemental device to secure the child restraint system after engaging it by the lower latches. Therefore, do not secure the child restraint system only with the top tether. The increased load may cause the hooks or anchors to break, causing serious injury or death.
- If a child restraint is not properly secured to the vehicle and a child is not properly restrained in the child restraint, the child could be seriously injured or killed in a collision. Always follow the instructions provided by the manufacturer for installation.
- Make sure the latches of the child restraint system are latched to the lower latches. In this case, you can hear the “click” sound.
- The child restraint seat strap may not work properly if attached somewhere other than the correct top tether.
- Make sure that the child restraint system is firmly secured by rocking it in different directions.
- Incorrectly installed child restraint system may cause an unexpected personal injury.

Air bag*

The air bag is an ancillary safety unit that inflates instantaneously in the event of a vehicle collision, protecting an occupant from the impact.

The air bag system is composed of the air bag crash sensor, air bag control module and air bag.

The air bag operates according to various factors including the strength and direction of a vehicle collision, strength of a colliding object, vehicle speed and the condition of the occupant.

Warning

- The air bag is an auxiliary unit that supplements the protection function of the seat belt and it cannot replace the seat belt. The seat belt should be fastened during driving.
- The air bag includes electric sensors and control modules and it only operates when the ignition switch is in the On position or the engine is running.
- The air bag is installed on the part where “AIRBAG” is displayed. Do not apply an impact to, place an article on or attach an accessory to the part where the air bag is installed. Doing so may cause a serious injury when the air bag inflates.
- When 10 years have passed after the air bag is installed, make sure to have the air bag checked at a KG Mobility Corporation Authorized Service Center even if there is no abnormality in the air bag system visually.

Air bag warning label

The air bag warning label displaying the risk of secondary damages in case the air bag inflates and safety information is attached to the passenger side sun visor. Read and familiarize yourself with the safety information before driving.



Warning

- The air bag is a unit that explodes a type of gunpowder in the unit and inflates the air bag instantaneously to protect the occupant. Therefore, noise, glare and smoke occur due to the explosion of gunpowder when the air bag inflates.
- The occupant may get burned when the air bag inflates. In some cases, the occupant may suffer injuries such as a bruise, bone fracture, abrasion and facial blows due to the inflated air bag and secondary damages such as broken glass.

Air bag warning lamp

The air bag warning lamp turns on when the ignition switch is turned On, and it turns off when there is no abnormality in the air bag system.



Warning

- If the air bag warning lamp stays on continuously, it indicates that there is abnormality in the air bag or the seat belt pretensioner system. Have your vehicle checked and serviced at a KG Mobility Corporation Authorized Service Center immediately.

Air bag crash sensor and air bag control module

The vehicle is equipped with sensors that can detect a collision and a module that controls the air bag operation.



- 1 Air bag control module
- 2 Front impact sensor (G-sensor type)
- 3 Side impact sensor (pressure sensor type)
- 4 Side impact sensor (G-sensor type)

Configuration of air bag

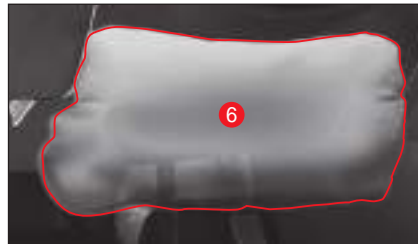
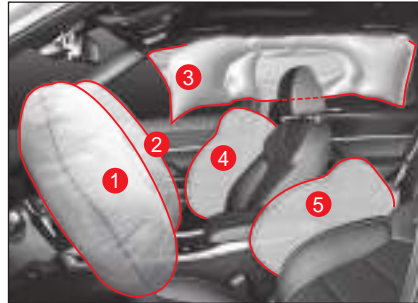

- 1 Driver air bag
- 2 Front passenger air bag
- 3 Curtain air bag
- 4 Front seat side air bag
- 5 Far side air bag
- 6 Driver knee air bag

Passenger Air Bag ON/OFF Switch*



The front passenger air bag is disabled (not inflatable) when placing the passenger air bag ON/OFF switch to "OFF" position. This switch is located on the right side of the instrument panel, and you can see it when opening the front passenger door. Press and turn this switch to operate.

"OFF" position: disabled (not inflatable)

"ON" position: enabled (inflatable)

Driver air bag

The driver air bag protects the driver's head in the event of a front collision.

The driver air bag is installed in the center of the steering wheel.



Warning

- The driver should sit as far as possible from the steering wheel within the range that it does not hinder the driver from controlling the vehicle. If the driver sits too close to the steering wheel, a fatal injury may occur when the air bag inflates.
- Do not place any object on or attach an accessory or a sticker to the air bag cover (steering wheel cover). Doing so may hinder the air bag from operating normally and increase a risk of injury when the air bag inflates.

Driver knee air bag

The driver knee air bag operates along with the driver air bag at the same time in the event of a front collision, protecting the driver's knees.

The driver knee air bag is installed in the dashboard under the steering wheel.



Warning

- Sit as far as possible from the dashboard where the front passenger air bag is installed. If the front passenger sits too close to the dashboard, a fatal injury may occur when the air bag inflates.

Notice

- The front passenger air bag operates along with the driver air bag at the same time.

Front passenger air bag

The front passenger air bag protects the front passenger's head in the event of a front collision.

The front passenger air bag is installed inside of the dashboard in front of the front passenger seat.



Front seat side air bag

The front seat side air bag protects the side of the front seat occupant in the event of a side collision that meets the condition for inflating the air bag.

The front seat side air bag is mounted in the side of the driver seat backrest and the front passenger seat backrest.



Warning

- Do not hang clothes or accessories or use seat covers on the seats where the side air bag is mounted.
- Do not apply impact to the area where the collision detection sensor for the side air bag (front seat backrest) is installed. Doing so may cause the side air bag to malfunction.

Far side air bag

The far side airbag unfolds between the passenger and the driver in the event of a side collision to prevent the passengers from being injured by a physical collision between them.



Warning

- Do not use seat covers or hang clothes/ accessories on the seats with far side air bag.

Curtain air bag

The curtain air bag protects the head of the front seat occupants and the rear seat occupants in the event of a side collision that meets the condition for inflating the air bag.

The curtain air bag is mounted on the roof at the top of the front and rear doors on both sides.



Warning

- Do not apply impact to the curtain air bag crash sensor (bottom part of the B pillar). Doing so may cause the curtain air bag to malfunction.
- Do not slam the door. Doing so may cause the air bag to malfunction.

Notice

- The side air bags and the curtain air bags operate at the same time in the event of a side collision, but the left and right side air bags and curtain air bags operate separately.

Cases where the air bag does not inflate

The air bag does not inflate in all collision accidents. The air bag may not inflate, in any of the following cases:

In the event of a slight collision

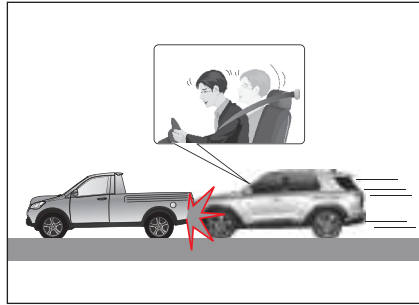

The air bag may not inflate in the event of a slight collision that the collision detection sensor cannot detect or the strength of collision is weak.

In such case, the seat belt can provide enough protection and the air bag operation may instead give secondary damages to the occupant such as a burn or an injury.

In the event of a rear end collision

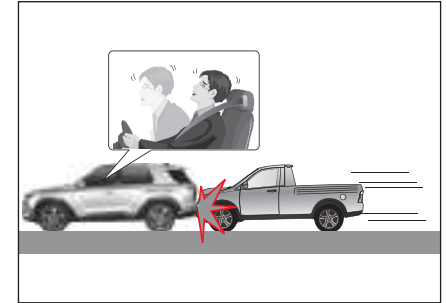

In the event of a rear end collision by another vehicle, the body of the occupants move backwards, so the air bag cannot provide enough protection even if it inflates. In such case, the air bag may not inflate.

In the event of a side collision



In the event of a side collision, the occupants cannot be protected by the front air bags, so the front air bags may not inflate.

However, the curtain air bags and the side air bags operate depending on the degree of impact in the event of a side collision, protecting the front seat occupants.

In the event of a diagonal collision

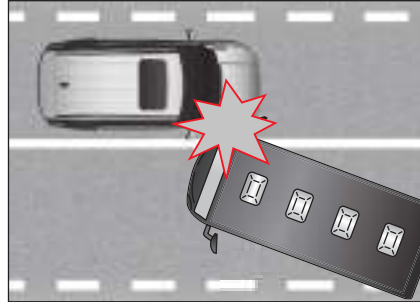

Since the impact of a collision in the diagonal direction is weaker than the impact of a collision in the front or side direction, the air bag may not inflate.

In the event of a collision with a narrow object



In the event of a collision with a narrow object such as a street light, utility pole or tree, the degree of impact applied to the sensor may not be enough, so the air bag may not inflate.

In case the vehicle moves beneath another vehicle

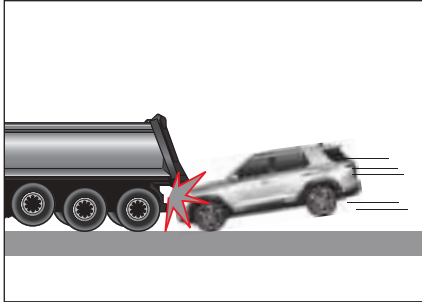

Generally, most drivers apply a sudden brake when an accident occurs, so the front part of the vehicle becomes lower. Therefore, the vehicle often moves beneath the opposing vehicle in the event of an accident against a tall vehicle such as a bus or a truck. In such case, the air bag may not inflate.

In the event of a rollover accident



If the vehicle turns over or rolls over, the occupant cannot be protected fully by the air bag alone. In such case, the air bag may not inflate.

However, the curtain air bag or the side air bag may inflate according to the degree of impact applied to the side when the vehicle turns over.

Secondary injury due to air bag deployment



If the air bag control module detects the impact during an accident, it transmits the signal to deploy the air bag. This signal triggers the explosion of the powder, which is included in the air bag module, and the air bag deploys in a very short time to protect the occupants. When the air bag inflates, there will be heavy noise, glare and smoke. You could suffer secondary injuries caused by inflated air bag such as an abrasion, a bruise, a burn or injury by broken glasses.

Other cases

Cases where the driver/front passenger air bags do not inflate

- When the air bag warning lamp is on
- When an impact is applied to the top of the engine hood by a falling rock, etc.
- When the vehicle falls into a drainage ditch or a puddle

Cases where the side air bags or curtain air bags do not inflate

- When the air bag warning lamp is on
- In case of a front or rear collision
- When the vehicle rolls over or turns over in the side direction with a moderate degree of impact

Warnings for the air bag



Warning

Seating an infant or a small child

- Do not let an infant or a small child sit in the front passenger seat or ride with an infant or a small child in your arms. The infant or the small child and you may get seriously injured or killed when the air bag inflates.
- Do not install a child restraint for an infant or a small child in the front passenger seat. If the air bag inflates, the infant or the small child may get seriously injured or killed due to the impact.
- When installing the child restraint for an infant or a small child in the rear seat of a vehicle where the curtain air bag is installed, install it as far as possible from the door. Failure to do so may cause serious injury or death of an infant or a small child when the curtain air bag inflates.

Driving and riding position

- Only hold the rim of the steering wheel when driving. Doing so ensures that the air bag inflates fully when it operates.
- Do not lean against the steering wheel or maintain your arms in an "X" shape. You may get seriously injured when there is a problem in the air bag operation or the air bag inflates.
- Do not drive while leaning forward or come too close to the steering wheel. You may get hit by the air bag and seriously injured on your head and neck or even killed before it inflates fully.
- If you wear the seat belt in an unstable position or while leaning to one side, the air bag cannot provide enough protection. You may even get seriously injured by the air bag.
- Do not place your feet or hands on the dashboard. You may get seriously injured when the air bag inflates.
- Do not lean against the door or stick your arm out of the window. You may get seriously injured when the curtain air bag inflates.

Handling the air bag

- Do not apply impact to air bag-related devices including the steering wheel, the part where the air bag is installed, wires and the seat belt pretensioner system. You may get seriously injured when the air bag inflates suddenly.
- Do not apply impact to the seat backrest where the side air bag is installed. Doing so may cause the side air bag to malfunction.
- Do not slam the door when closing the door. Doing so may cause the curtain air bag or the front air bag to malfunction.
- Do not place any object between the air bag and the occupant. Doing so may hinder the operation of the air bag and you may get injured by such an object when the air bag inflates.
- After the air bag and the seat belt pretensioner operate, their relevant components become very hot. Never touch such components until they have cooled down.

Operation of the air bag

- The air bag is a unit that protects the life of a passenger from a sudden accident, and it inflates at high speed by hot gas. The occupant may suffer injuries such as a burn, abrasion or bruise according to the circumstances at the time when the air bag inflates.
- A loud noise, dust, smoke or gas that occurs when the air bag or the seat belt pretensioner operates is normal.
- Gas generated when the air bag or the seat belt pretensioner operates is nontoxic, but if your skin, eyes or nose becomes irritated, wash with clean water. If the symptom persists, consult your doctor.
- Caution should be taken that the windshield or window glasses may be broken due to an impact from the operation of the front seat air bag or curtain air bag.

Do not modify the air bag or change the structure

- Do not modify or change the structure of any air bag-related devices including the steering wheel, the part where the air bag is installed or the wires. Do not check an air bag-related circuit with a tester. Doing so may cause the air bag system to malfunction or break down, resulting in personal injury and property damage.
- Do not replace the steering wheel with a product which is not a KG Mobility Corporation genuine part. Doing so may cause the air bag in the steering wheel not to operate normally.

Tire pressure monitoring system (TPMS)*

The tire pressure monitoring system (TPMS) is an auxiliary safety unit that detects if the tire pressure is abnormally high or low and informs such fact to the driver, preventing an accident that may occur due to the tire pressure.

- The global warning light (⚠) comes on if the tire pressure is abnormal.
- Also, if there is abnormality in the tire pressure monitoring system (including the sensor), the global warning light (⚠) blinks and stays on.

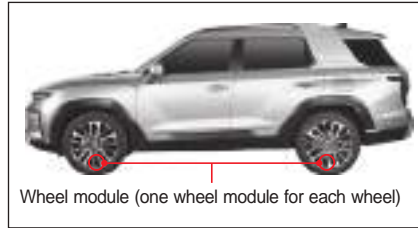

The electronic control unit of the TPMS receives various data including the tire pressure and temperature from the wheel module mounted on each wheel and displays such data on the instrument cluster.

- Proper tire pressure: 34 psi, 2.3 bar
- The proper tire pressure is the value measured at room temperature (20 °C) in the condition of an empty vehicle when the tires have been cooled properly.

Notice

- If the vehicle is driven at a speed of 20 km/h or faster after the engine is started, the tire pressure is detected within 5 minutes although it might be slightly different depending on the system status. If the tire pressure is not sensed, “-” will be displayed.

⚠ Caution

- The tire pressure displayed on the display of the instrument cluster can be changed by various environmental factors including the driving status of the vehicle, number of occupants in the vehicle and the status of air injection into the tires.
- When air is injected into a tire, air with different temperature are mixed, so the tire pressure may be changed until a temperature balance is reached.

Checking the tire pressure

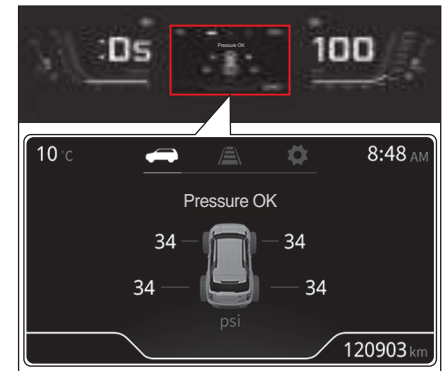

By selecting TPMS status from the main menu of the instrument cluster, you can check all tire pressures from the display of the instrument cluster.

If the tire pressure or the TPMS is abnormal



If the tire pressure or the tire pressure monitoring system is abnormal, the global warning light blinks or comes on.

- Abnormal tire pressure (low/flat): The global warning light stays on.
- Abnormal tire pressure monitoring system (including the sensor): The global warning light blinks for approximately 70 seconds and stays on.



Warning



- If the global warning light comes on in the instrument cluster, the tire pressure is insufficient, excessive or uneven. Make sure to park your vehicle at a safe place and check the tire pressure.
- If the global warning light stays on after checking the tire pressures, starting the engine and driving the vehicle for more than 10 minutes at a speed over 20km/h, have your vehicle checked and serviced at a KG Mobility Corporation Authorized Service Center.
- A sudden tire damage due to an external factor such as a nail or a road debris, etc. may not be detected immediately. If the vehicle becomes unstable while driving, slow down, move the vehicle to a safe place and check the vehicle.
- Do not modify or remodel your vehicle in a way that hinders the operation of the TPMS.
- For safety, always use genuine wheels equipped with the tire pressure monitoring sensor.

Caution

- Adjust the tire pressure when the tires are cold (no driving for 2 or 3 hours).
- Even if the tire pressure has been adjusted to a proper tire pressure, the global warning light () may come on due to a difference in the internal tire temperature and air temperature. This is the phenomenon that the tire pressure drops in proportion to the temperature and this does not indicate that the TPMS is abnormal.
- If you need to drive while the ambient temperature rises or drops rapidly, check and adjust your tire pressure to the prescribed inflation pressure in advance before driving.
- For safe driving, check your tire pressure regularly without simply depending on the TPMS.

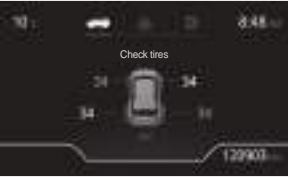
Display of the TPMS status on the instrument cluster

Item	Main menu	Operating condition
Tire pressure OK		<ul style="list-style-type: none"> It is displayed when the tire pressure is normal.
Low pressure		<ul style="list-style-type: none"> In order to detect whether the tire pressure is normal or insufficient, the TPMS wheel module must be properly installed on each wheel. After IGN ON, it takes several seconds for the TPMS ECU and TPMS wheel module to communicate normally, and during this time, each state is displayed.
		<ul style="list-style-type: none"> It is displayed when the tire pressure is insufficient to the extent that it is to be checked (approximately 20% less than the specified tire pressure). The corresponding tire's pressure indicator blinks (alternating white and red) and the global warning light turns on.
Check tires		<ul style="list-style-type: none"> It is displayed when the tire pressure is insufficient to the extent that it is to be checked (approximately 23.9 psi or less). The corresponding tire's pressure indicator blinks (alternating white and red) and the global warning light turns on.

Item	Main menu	Operating condition
Flat tire		<ul style="list-style-type: none"> • It is displayed when the tire pressure drops sharply or there is a flat tire. The corresponding tire's pressure indicator blinks (alternating white and red) and the global warning light turns on.
High pressure		<ul style="list-style-type: none"> • It is displayed when the tire pressure is excessive. The corresponding tire's pressure indicator blinks (alternating white and red).
Pressure imbalance		<ul style="list-style-type: none"> • If the left/right tire pressure differs by more than 5 psi, the corresponding tire pressure indicator blinks (alternating white and orange).

<p>Notice</p>	<ul style="list-style-type: none"> • If a certain tire pressure is shown as "--" while the other tire pressures are shown normally, the TPMS wheel module of the relevant tire may be abnormal. Have your vehicle checked and serviced at a KG Mobility Corporation Authorized Service Center immediately. • If all tire pressures are displayed as "--", it is possible that two or more TPMS wheel modules are defective or communication with the ECU has failed. In this case, immediately have the vehicle checked and serviced at a KG Mobility Dealer or KG Mobility Authorized Service Center.
----------------------	--

When low tire pressure is detected

When a tire with significantly low pressure is detected, the global warning light () comes on and the position of the relevant tire with low pressure is indicated on the instrument cluster.

In such case, slow down, bring your vehicle to a KG Mobility Corporation Authorized Service Center and have your vehicle checked and serviced.



Caution

- If you drive the vehicle continuously with a low tire pressure, the life of the tires, vehicle operating force, brake force and vehicle fuel efficiency may decrease.
- If you cannot bring your vehicle to a KG Mobility Corporation Authorized Service Center, add air to the tire using the service kit for tire repair.

 Refer to "Inflating a tire" (p.5-15)

When you have rotated the tires

When you have rotated the tires, the TPMS resets the position of each tire.

If the vehicle is driven at a speed of 20 km/h or faster, typically the system completes the reset within 5 minutes although it might be slightly different depending on the system status.

 Refer to "Rotating the tire positions" (p.6-38)



Warning

- If you replace a tire where sealant has been injected for repairing the tire, be sure to have the exterior of the TPMS sensor and the TPMS checked for normal operation at a KG Mobility Corporation Authorized Service Center.



Caution

- If you rotated the tires or replaced a wheel module including the tire pressure detection sensor, the tire position may not be recognized correctly at the beginning of driving so that the previous tire pressure may be displayed or the global warning light () may turn on. This is a temporary state which is not a failure.
- The time taken for resetting the tire position may vary depending on the driving condition of the vehicle.

Cautions for the TPMS



Caution

- If a wheel without a wheel module (tire pressure detection sensor) is installed to the vehicle, the global warning light turns on and the TPMS does not operate.
- Do not rely too much on the TPMS and be sure to check the tire pressure status before driving the vehicle.
- The TPMS operates in a way that it communicates with the wheel module by wireless. Therefore, if an electronic device such as a mobile speed camera detector that can create radio interference is installed to the vehicle, the TPMS may not operate normally.
- In an area with a strong electromagnetic field (police stations, government offices, broadcasting stations, military facilities, transmitting towers, etc.), the TPMS may fail and the global warning light (⚠) may turn on.
- If any foreign object is caught in the transmitter attached to the tire wheels while driving on a muddy or snowy road, hindering the communication with the receiver of the vehicle, the radio interference occurs due to strong external waves or a metal object is located near the TPMS, the tire pressure may be displayed with a time delay or may not be displayed normally.

- When you drive the vehicle with snow chains installed, the snow chains may hinder the communication between the wheel module and the antenna so that the TPMS may not operate normally. However, this does not impair the operation of the vehicle.
- When air is injected into a tire, the tire pressure displayed on the air injection device may be different from the tire pressure displayed on the TPMS. This difference is caused by factors including the driving status of the vehicle, number of occupants in the vehicle and the status of air injection into the tire and this does not indicate the failure of the TPMS.
- Be careful not to damage the wheel module when the tires are replaced. If the wheel module receives an impact or is damaged when the tires are replaced, the tire pressure detection function does not operate.
- If you have your tires replaced at a tire shop other than a KG Mobility Corporation Authorized Service Center, be sure to inform that the TPMS has been fitted to the tires.
- The life of the battery in the tire pressure detection sensor (wheel module) may be reduced if abnormalities such as checking tire pressure, low pressure, high pressure and pressure imbalance occur frequently.

Immobilizer system*

The immobilizer system is a vehicle anti-theft system that prevents it from starting the engine unless a permitted key is used.

The engine can be started only when the code of the transponder integrated in the smart key (rekes key) has been authenticated by comparing it with the code of the engine control unit.

Caution

- **The immobilizer system cannot be removed from the vehicle under any circumstance. If you arbitrarily remove or damage the immobilizer system, you cannot start the engine. Never remove, damage or modify the immobilizer system.**
- **The immobilizer system should be repaired only by a licensed technician at a KG Mobility Corporation Authorized Service Center.**
- **When the code of the transponder is deleted or an additional key is registered, observe the process in person.**
- **Do not install a metallic accessory near the smart key (rekes key) or the ignition switch. Such accessory changes the signal delivered to the ignition switch, preventing it from starting the engine.**
- **Do not drop the smart key (rekes key) or apply impact to it. Doing so may damage the transponder.**
- **Do not modify the vehicle arbitrarily to install a remote starting device. Doing so may cause a problem in starting the engine or a fatal accident.**

Immobilizer/smart key warning light

If the immobilizer or the smart key system is abnormal, the immobilizer/smart key warning light will blink.



Notice

- **The communication time between the transponder and the engine control unit varies depending on the case. If the communication time is short, the warning lamp may not be lit.**

If the engine does not start

In the event of the communication error between the transponder and the engine control unit due to a system internal fault or external communication obstacle, the engine will not start.

In such case, the immobilizer warning light will blink.

You may not be able to start the engine in a vehicle with the immobilizer system, in any of the following cases:

- When two or more smart keys come into contact with each other are used
- When the smart keys is used near a device that sends or receives electromagnetic fields or waves
- When the smart keys is used near electric or electronic devices such as lighting equipment, security keys or security cards
- When the smart keys is used near a key chain, a magnet, a metallic object or a battery
- When you start the engine before the engine preheating time ends



Caution

- **You may not be able to start the engine due to an external factor (key chain, magnet, etc.) or early starting before the engine preheating time to cause communication failure with the immobilizer. In such case, eliminate the factor preventing it from starting the engine, place the smart key outside the operation range of the antenna for approximately 10 seconds or longer and start the engine again.**
- **If the immobilizer/smart key warning light blinks continuously and you still cannot start the engine after eliminating the external factor, have your vehicle checked and serviced at a KG Mobility Authorized Service Center.**

When the transponder is damaged

You can't start the engine with a key whose transponder is damaged. In such case, replace the smart key with a new one and register the relevant code on the engine control unit.

When you lose the key

When you lose your key, the transponder code of the lost key registered on the engine control unit should be deleted.

Have KG Mobility Authorized Service Center take measures for preventing vehicle theft by a lost key.

Theft deterrent system

The theft deterrent system is a device that prevents theft of the vehicle by activating the anti-theft alarm when the door, tailgate or engine hood is open in an armed mode.

Entering the theft monitoring mode

When the door lock button (including the door lock/unlock button on the exterior of the front doors) of the remote key or smart key is pressed with all doors, tailgate and engine hood closed, the system enters the theft monitoring mode.

- When the system enters the theft monitoring mode, the warning light blinkstwic and the warning buzzer sounds once.
- **Remote control key:** When the theft deterrent system is armed, the hazard flashers blink twice. However, if you press this button once again in 4 seconds, the hazard flashers blink twice and the buzzer sound once.
- **Smart key:** When the theft deterrent system is armed, the hazard flashers blink twice and the buzzer sound once.
- If approximately 30 seconds have passed without opening the door after unlocking the door using the remote key or smart key in the theft monitoring mode, all doors are locked again and the system enters theft monitoring mode.



Caution

- If you insert the key into the door key hole and lock the doors, only the doors are locked but the theft deterrent system is not activated.
- The system enters the theft monitoring mode only when the ignition switch is on Off and all doors, tailgate and engine hood are closed completely.
- If the ignition switch is on Acc or On or the engine is being started, the system does not enter the theft monitoring mode.

Activating the theft alarm

In the theft monitoring mode, the warning light and the warning buzzer operate at an interval of 1 second for 30 seconds in any of the following cases:

- When an attempt to open the door, tailgate or engine hood without using the smart key is made
- When the key is inserted into the key hole to open the door
- When the door lock lever is placed in the unlock position forcibly

When the theft deterrent system is activated, the alarm stops in any of the following cases: However, the theft monitoring mode is maintained at this time.

- When the door lock button or door unlock button on the smart key is pressed
- When the door lock/unlock button on the exterior of the front door is pressed
- When the ignition switch is On
- **Remote control key:** pressing “Lock”, “Unlock”, “Panic” button on the remote control key, or turning the ignition switch to “ON” position
- **Smart key:** pressing “Lock” or “Unlock” button on the Smart key, pressing the “Lock/Unlock” button on the outside door handle, or turning the ignition switch to “ON” mode by pressing it.

Holding the theft alarm

The alarm does not sound and is on hold in any of the following cases:

- When the tailgate is opened by pressing the open tailgate button on the smart key
- When the tailgate is opened by pressing the open button inside the tailgate door handle with the smart key detected

Notice

- **An armed mode is maintained even if the tailgate is open in an anti-theft alarm hold state. When the tailgate is closed, it also returns to an armed mode.**

Canceling the theft monitoring mode

The theft monitoring mode is canceled when the door is switched to the Unlock position using the remote key or smart key (including the door lock/unlock button on the exterior of the front doors).

Notice

- **When the theft monitoring mode is canceled, the warning light blinksonce and the warning buzzer sounds twice.**
- **All doors are locked again and the system enters theft monitoring mode, when approximately 30 seconds have passed without opening the door after unlocking the door using the smart key in the theft monitoring mode.**

3. Convenient Equipment

You can check information regarding devices that allow you to drive the vehicle conveniently and wisely and how to use such devices.

An explanation is provided for doors, seats, windows as well as various convenient equipment including the tailgate, various lights and lamps, mirrors, heater and air conditioner, Smart Audio, storage and cargo box.

How To Lock/Unlock & Open Door

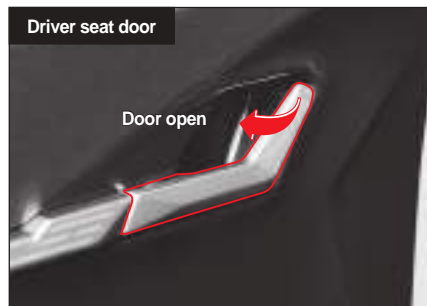

Door Opening Lever

- Driver door opening lever
Pulling the door opening lever with the door locked will unlock all doors and open the driver's door.
- Front passenger door opening lever
Pulling the door opening lever with the door locked will unlock all doors. At this time, pull the door opening lever again to open the front passenger's door.
- Rear door opening lever
Pulling the door opening lever with the door locked will unlock that rear door only. At this time, pull the door opening lever again to open the door.

Warning

- Take care not to allow the door to open by pulling the door opening lever while driving. If any door is open while driving it can pose a serious risk.

How To Check If Door Locked/Unlocked

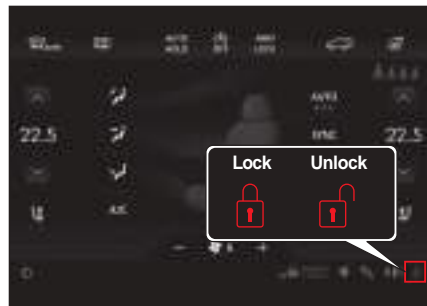

- The buttonless integrated control panel allows you to confirm that the door is locked/unlocked.

Notice

- When any door is unlocked, the door unlock indicator is displayed.

Door Lock/Unlock button

Each time the door Lock/Unlock button on the driver seat is pressed, the status of all doors and the tailgate is changed between locked and unlocked alternately.



Caution

- You cannot lock the door using the door Lock/Unlock button or the smart key when the door is opened even slightly.
- You cannot unlock the door with the driver door Lock/Unlock button in theft monitoring mode.



Warning

- Before driving the vehicle, lock all doors from the driver seat using the door lock/unlock lever. Be sure to drive the vehicle with all doors locked when a child is present in the vehicle. If the door is opened suddenly while driving, you may face a serious risk.
- Before you get out of the vehicle, check the rear and front sides of the vehicle first to see if there is any vehicle, motor cycle, bicycle or person passing by. In particular, opening the door without checking the rear side may lead to an accident.

Auto door lock function at the time of driving

When the vehicle speed exceeds the set speed, all doors and tailgate are automatically locked.

Notice

You can set at **User setting** → **Door / Tailgate** → **Auto lock** under  (user settings) in the instrument cluster.

Auto door unlock function at the time of collision

When a collision accident occurs with all doors locked and the air bag is activated, all doors are unlocked automatically.



Warning

- If the vehicle body or a door has been deformed due to an impact from an accident, the auto door unlock function may not operate normally.

How To Lock Doors In Emergency

If you cannot lock the doors using a smart key because of dead battery, wave interference or etc., you may use the mechanical key (secondary key) to lock the doors manually. (excluding driver door)

☞ Refer to “Unfolding/folding the emergency key” (p.4-17)

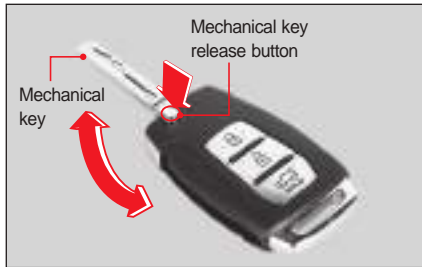

- Pull out the mechanical key by pressing the mechanical key release button of the smart key/REKES key.
- To fold in the mechanical key, fold the mechanical key while pressing the mechanical key release button.

⚠ Caution

- **Attempting to fold in the mechanical key without pressing the mechanical key release button can lead to smart key breakage.**

To lock doors with mechanical key (excluding driver door)

- 1 Open the door, insert the mechanical key into the emergency lock located behind the door and turn the key in the direction of the arrow.

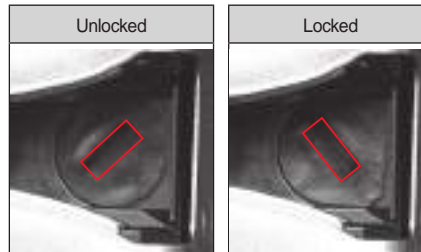

- 2 Close the door with the groove of the emergency lock still locked.

⚠ Caution

- **If the door is locked using an emergency lock, the door can be unlocked using the Smart key/REKES key or by pulling the door opening lever from the vehicle interior.**

Child safety door lock

The child safety door lock is installed in order to prevent a child from opening the door in the vehicle when a child is present in the rear seats.

The child safety door lock is provided at the inner side of the rear seat doors.



Locking/unlocking the door lock

When the child safety door lock is locked, the rear seat doors cannot be opened with the door open lever in the vehicle even if the rear seat doors are unlocked. In such case, the rear seat doors can be opened only from the outside of the vehicle.

Locking the child safety door lock

Place the child safety door lock lever in the lock position by turning it counterclockwise.

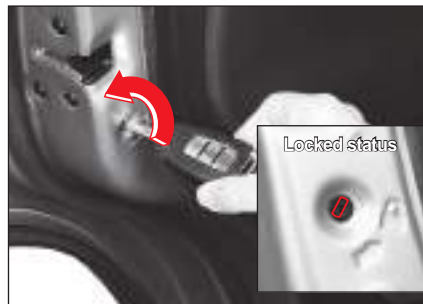

Unlocking the child safety door lock

Place the child safety door lock lever in the unlock position by turning it clockwise.



Warning

- When a child is present in the vehicle, place the child safety door lock lever in the lock position to prevent the child from opening the door in the vehicle.

Seat & adjustment switch / button / lever

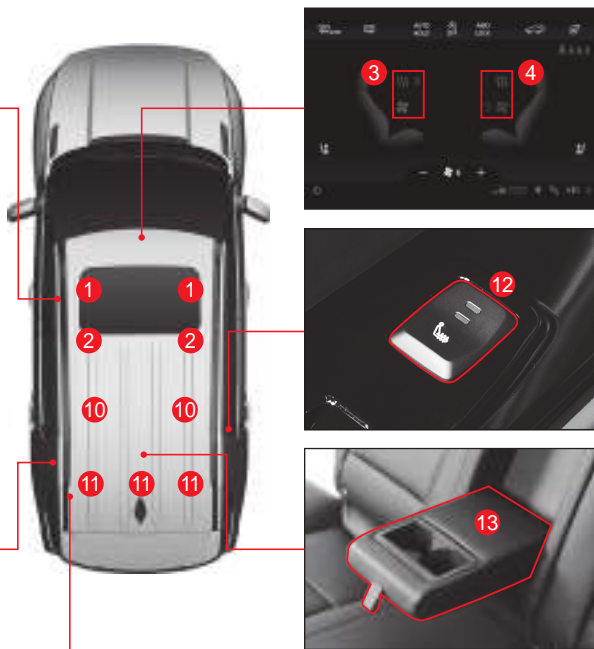
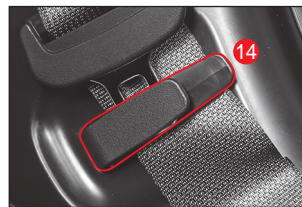

Front seat

- 1 Front seat
- 2 Sliding headrest
- 3 Driver seat ventilation and heating switch (LTCM)
- 4 Front passenger seat ventilation and heating switch (LTCM)
- 5 Backrest angle control lever
- 6 Seat cushion angle control lever
- 7 Seat height control lever
- 8 Seat front and rear position control lever
- 9 Lumbar support control button (driver seat)

Rear seat

- 10 Rear seat (6:4 split type)
- 11 Headrest
- 12 Rear seat warmer button
- 13 Rear armrest (cup holder)
- 14 Rear seat webbing guide
- 15 Seatback reclining adjustment lever (folding)

Front seat

Adjusting the headrest

Adjusting the front and rear angles

- Push the rear section of the headrest (1) in the arrow direction. The angle of the headrest can be adjusted in 3 levels.
- To return the headrest to its original position, push it to the end in the arrow direction again and release it.



Adjusting the height

- To raise the headrest, hold and pull the headrest up.
- To lower the headrest, push the headrest down with the Lock button (1) pressed in the arrow direction.



Notice

- Adjust the height of the headrest so that the center of the headrest is aligned with the occupant's eye level.
- It may not be possible to align the center of the headrest with the occupant's eye level due to the occupant's physical condition. In such case, align the height of the headrest with the highest position for a tall person and the lowest position for a short person.

Separation/installation

Separating the headrest

- 1 Recline the seat backrest to secure necessary space for separating the headrest safely.
- 2 With the Lock button (1) pressed in the arrow direction, separate the headrest by lifting it to the end.



- 3 Return the seat backrest to its original position.

Warning

- Never drive the vehicle with the headrest separated. Doing so may cause head, neck or spine injury.

Installing the headrest

- 1 Recline the seat backrest to secure necessary space for installing the headrest safely.
- 2 Insert the headrest into the groove of the seat backrest.
- 3 With the Lock button (1) pressed in the arrow direction, pull down the headrest to the desired position.
- 4 Return the seat backrest to its original position.

Adjusting the power seat*

Front and rear position adjustment (driver seat/front passenger seat)

Set the seat to the desired position by pulling or pushing the front and rear position adjustment lever.



Adjusting the height (driver seat/front passenger seat)

Set the desired height by raising or lowering the height adjustment lever.



Adjusting the cushion angle (driver seat/ front passenger seat)

Set the desired angle by raising or lowering the cushion angle adjustment lever.



Adjusting the backrest angle (driver seat/ front passenger seat)

Set the desired angle by pulling or pushing the backrest angle adjustment lever.



Warning

- Adjust the seat backrest to be upright as possible to maintain a comfortable position. Reclining the seat backrest excessively may cause the occupant to slip down below the seat belt in the event of a vehicle collision or sudden stopping. In such case, the occupant cannot be protected by the seat belt and the air bag, so the occupant may receive a serious injury or lose his/her life.

Adjusting the lumbar support (driver seat)

Set the lumbar support to the desired position by pressing the Lumbar support adjustment button.

- When you press the Forward/Backward adjustment button (1 / 2), the lumbar support is extended or retracted.



Warning

- Never adjust the seat while driving. If the seat moves suddenly, it may lead to a dangerous situation.
- After adjusting the seat, check that the seat is secured firmly.
- If there is an occupant in the rear seat, adjust the seat while paying attention to the safety of the occupant.
- If the power seat does not operate, drive the vehicle after checking and taking measures.

Caution

- Operating the power seat excessively may damage the electric devices. Use it only for adjusting the seat.
- Operating a number of seat adjustment switches at the same time may damage the motor. Be sure to finish using one function before using another function.
- The power seat operates even when the START/STOP switch is in the OFF status. However, caution should be taken that operating the power seat too frequently when the engine is turned off may cause depletion of the battery.
- If the height of the seat and headrest is high with the front seats pulled forward, be careful when folding the seat backrest forward. Failure to do so may cause the front seats, headrest, sun visor and other components to bump against each other, causing damage.
- If the power seat comes into contact with an object so that it does not move or operate, do not operate it forcibly. Operate it again after eliminating the cause. If there is abnormality, have your vehicle checked and serviced at a KG Mobility Corporation Authorized Service Center.

Adjusting the seat manually

Front and rear position adjustment (driver seat/front passenger seat)

With the front and rear position adjustment lever pulled up, set the seat to the desired position by pulling or pushing the seat.



Adjusting the backrest angle (driver seat/ front passenger seat)

With the backrest angle control lever pulled up, move and set the backrest at the desired angle.



Warning

- Adjust the seat backrest to be upright as possible to maintain a comfortable position. Reclining the seat backrest excessively may cause the occupant to slip down below the seat belt in the event of a vehicle collision or sudden stopping. In such case, the occupant cannot be protected by the seat belt and the air bag, so the occupant may receive a serious injury or lose his/her life.

Adjusting the height (driver seat)

Set the desired height by raising or lowering the height adjustment lever.



Rear seat

Adjusting the height of the headrest

- To raise the headrest, hold and pull the headrest up.
- To lower the headrest, push the headrest down with the Lock button (1) pressed in the arrow direction.



Warning



- Adjust the height of the head restraint so that the center of the head restraint is aligned with the occupant's eye level.
- Do not use the head restraint while it is lowered.
- When there is no occupant in the rear seats, the rear head restraints should be kept as low as possible as since they may obscure the rear view.

Notice

- Due to the occupant's physical condition, the center of the head restraint may not be able to align with the his or her eye level. In this case, set the height of the head restraint to the highest position for tall people and the lowest position for short people.

Seatback reclining adjustment

You can adjust the reclining in step 1 or 2 while pulling the seatback release lever (1) at the side of the rear seat backrest.

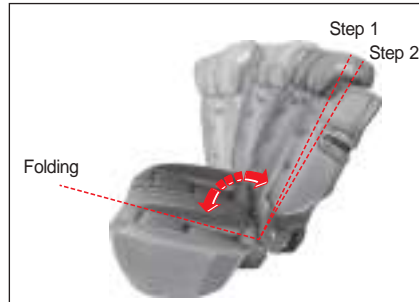

Caution

- When locking the rear seat backrest, make sure that the backrest unlock lever (1) clicks into the locked position so that the red label ("Unlocked" indicator) is not visible.



Rear seat backrest folding

- 1 Insert the seat belt into the webbing guide to prevent the seat belt from being damaged.
- 2 Position the headrest to its lowest level.

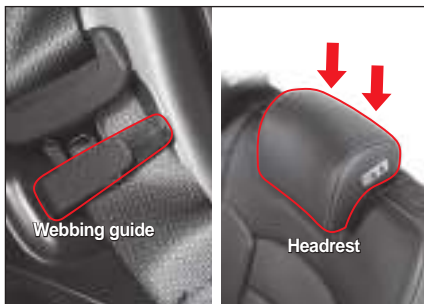

⚠ Caution

- When folding or unfolding the seat, it may hit and damage other components. To prevent such damage, lower the headrest of the seat to be folded to its lowest position and position the backrest of the seats in front of the folded seats.

- 3 Pull the rear seat backrest release lever (1).



- 4 Fold the backrest toward the front side of vehicle.

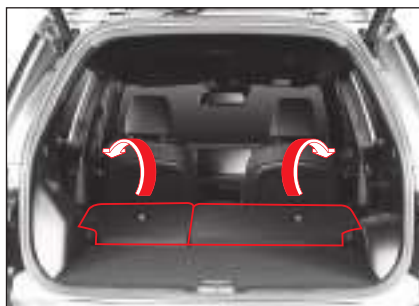

When returning the backrest to its original position, operate it in the reverse order.

⚠ Warning

- After returning the seat to its original position, gently rock the seat to make sure it is securely locked. If the seatback is not locked completely, it can be folded down unexpectedly.
- Be careful not to get your body parts to be caught in between the seats when folding the seat.
- Do not sit on the folded seat. You cannot be protected by the seat belt and other safety units and may be seriously injured in the event of an accident.
- When placing an article on top of the folded seat, secure the article firmly so that it won't move while driving. If the article moves, the driver and other passengers may get injured by the moving article. Also, a secondary accident may occur accordingly.

Seat Ventilation & Heating

Front seat ventilation and heating*

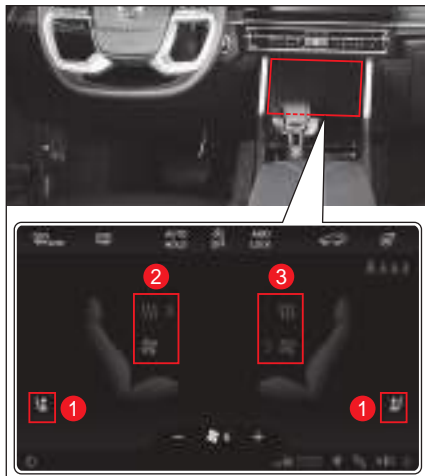

- 1 Ventilation and heating toggle switch
- 2 Driver's seat ventilation and heating switch
- 3 Front passenger's seat ventilation and heating switch

Notice

- If the switch is not operated for a certain period of time (approximately 8 seconds) on the front seat ventilation and heating pop-up screen, it will switch to the climate control screen.

Front seat ventilation

Touch the ventilation and heating toggle switch (1) with the engine started and then touch the ventilation switch (2).

When the ventilation of the corresponding seat is activated, its level is displayed, and the level is indicated by the number of blue dots at the bottom of the toggle switch.

- OFF: Gray symbol shown
- ON:
 - Switch (2) (3): Blue symbol + Show corresponding levels
 - Switch (1): Number of blue dots corresponding to levels displayed



- Each time the ventilation switch is touched, ventilation operates in order of OFF → 3rd level → 2nd level → 1st level → OFF.

Warning

- Do not insert your hand under the seat cushion while the seat ventilation function is operating. Doing so may cause your hand to be hit and injured by the spinning ventilation fan.

Notice

- The seat ventilation function is not the cooling seat that blows out cold air from the air conditioner.
- Since the seat ventilation function draws in air from inside the vehicle and performs the ventilation function, it is efficient to use it together with the air conditioner.
- When you turn off the engine while the seat ventilation function is operating, the ventilation function also turns off. The seat ventilation function won't turn on even if you start the engine again.
- Ventilation is turned off by touching the ventilation switch or turning the engine off and on.

Front seat heating*

Touch the ventilation and heating toggle switch (1) with the engine started and then touch the heating switch (2,3).

When the heating of the corresponding seat is activated, its level is displayed, and the level is indicated by the number of red dots at the bottom of the toggle switch.

- OFF: Gray symbol shown
- ON:
Switch (2,3): Red symbol + Show corresponding levels
Switch (1): Number of red dots corresponding to levels displayed



- Each time the heating switch is touched, heating operates in order of OFF → 3rd level → 2nd level → 1st level → OFF.

Smart front seat heating control

This function controls the heating operation status automatically while assisting you to drive safely in a proper temperature condition.

- If the status of level 3 is maintained for approximately 30 minutes, the status of the heating function is changed to level 2 automatically.
- After the status is changed to level 2
 - When you activate the heating function in level 3 again within 5 minutes, the status of level 3 is maintained for approximately 8 minutes and then the status is changed to level 2 automatically.
 - When you activate the heating function in level 3 again after 5 minutes later, the status of level 3 is maintained for approximately 30 minutes and then the status is changed to level 2 automatically.
- If the status of level 2 is maintained for approximately 60 minutes, the status of the heating function is changed to level 1 automatically.

Warning

- Using seat heating excessively on the driver seat may cause drowsiness and interfere with safe driving.

Notice

- The seat heating function is designed to stop its operation when the temperature rises to a certain level and resume its operation when the temperature falls below a certain level.
- When you turn off the engine while the seat heating function is operating, the heating function also turns off. The seat heating function won't turn on even if you start the engine again.
- Heating is turned off by touching the heating switch or turning the engine off and on.

Rear seat heating*

With the engine on, press the 1st row rear seat heating button.

The operation indicator (yellow) turns on and the heating function is activated in the relevant seat.



- Every time the heating button is pressed, the warmer is operated in the order of OFF → Level 2 → Level 1 → OFF.

Rear seat heating smart control

- This function automatically controls the operation status of the warmer and helps the driver to operate the vehicle safely at an appropriate temperature.
- After operating for about 30 minutes in level 2, it automatically changes to level 1.
- After being changed to level 1
 - If you operate the warmer at level 2 again within 5 minutes, it will stay the level for about 8 minutes and change to level 1 automatically.
 - If you operate the warmer at level 2 again after 5 minutes, it will stay the level for about 30 minutes and change to level 1 automatically.

Warning

- Caution should be taken that using the seat heating function excessively may cause a minor burn. Pay particular attention to an infant, a small child, an elderly, a disabled person, a person who took a drug that induces sleep, a drunk person, an over-worked person or a person with delicate skin.
- Caution should be taken that you may get a low temperature burn if your skin comes into contact with the heated seat for a long period of time.
- While using seat heating, do not place a blanket, cushion or sitting mat on the seat to prevent overheating.
- Using the seat heating excessively may cause overheating or fire. Be sure to check whether the seat heating is operating or not when getting in and out of the vehicle.
- If the seat becomes hotter continuously and out of control, turn off the seat heating function first. And, have your vehicle checked and serviced at a KG Mobility Corporation Authorized Service Center immediately.

Notice

- The seat heating function is designed to stop its operation when the temperature rises to a certain level and resume its operation when the temperature falls below a certain level.
- When you turn off the engine while the seat heating function is operating, the heating function also turns off. The seat heating function won't turn on even if you start the engine again.

Warnings and cautions related to the seats



Warning

- Be sure to finish adjusting the seat before driving.
- Never adjust the seat while driving. If the seat moves suddenly, it may lead to a dangerous situation.
- Adjust the seat backrest to be upright as possible to maintain a comfortable position. Reclining the seat backrest excessively may cause the occupant to slip down below the seat belt in the event of a vehicle collision or sudden stopping. In such case, the occupant cannot be protected by the seat belt and the air bag, so the occupant may receive a serious injury or lose his/her life.
- Never drive the vehicle with the headrest separated. Doing so may cause head, neck or spine injury.
- If the power seat does not operate, drive the vehicle after checking and taking measures.
- Caution should be taken that using the seat heating function excessively may cause a minor burn. Pay particular attention to an infant, a small child, an elderly, a disabled person, a person who took a drug that induces sleep, a drunk person, an over-worked person or a person with delicate skin.



Caution

- The power seat operates even when the START/STOP switch is in the OFF status. However, caution should be taken that operating the power seat too frequently when the engine is turned off may cause depletion of the battery.
- Operating a number of seat adjustment switches at the same time may damage the motor. Be sure to finish using one function before using another function.
- If the power seat comes into contact with an object so that it does not move or operate, do not operate it forcibly. Operate it again after eliminating the cause. If there is abnormality, have your vehicle checked and serviced at a KG Mobility Corporation Authorized Service Center.
- Do not place an object that can damage the seat upholstery on top of the seat.
- Do not use organic solvents such as thinner, benzene, alcohol or gasoline for cleaning the seat upholstery. Doing so may damage the surface of the upholstery.

Window (power window)*



- 1 Driver seat window button (AUTO)
- 2 Front passenger seat window button (AUTO)
- 3 Rear left window button
- 4 Rear right window button
- 5 Rear seat window lock button

Notice

- To operate the window, the START/STOP switch should be in the ON status or the engine should be running.
- Even if the START/STOP switch is switched from the ON status to the ACC status or the OFF status, the Window button can be operated for approximately 30 seconds. However, the operation stops immediately when you open the front door.

Opening the driver seat/front passenger seat window



- Press the Driver seat/Front passenger seat window button slightly. The Window opens only while the button is being pressed.
- Press the Driver seat/Front passenger seat window button to the end and release it. The window opens to the end automatically (auto down).
- When you slightly press or pull the Driver seat/Front passenger seat window button up while the window is opening, the window stops.

Notice

- The vehicles with Auto Down have not fitted with the Auto Up and the window is closed only while the switch is being pulled.

Closing the driver seat/front passenger seat window



- Pull the Driver seat/Front passenger seat window button up slightly. The window closes only while you are pulling the button.
- Pull the Driver seat/Front passenger seat window button up to the end and release it. The window closes to the end automatically (auto up).
- When you press or slightly pull the Driver seat/Front passenger seat window button up while the window is closing, the window stops.

Driver seat window safety function

The driver seat window safety function controls the driver seat window equipped with the auto up function to move down slightly and stop without moving up from its position when it is recognized that a body part or an object is caught in it when the window is closing.



Notice

- The window safety function is activated **only on the driver seat window equipped with the auto up function.**
- The safety function is **not activated for some section of the window that is closed lastly.**
- The window may get frozen during winter so that it may be misrecognized as a body part or an object being caught in it. In such case, close the window little by little by pulling the Window button slightly.
- When you do not release the Window button after pulling it up to the end, the window is closed to the end without stopping even if there is an obstacle in its moving path.

This function is intended to protect the driver from a crime such as robbery and injury.

Opening/closing the rear seat window



The window only works while pressing or pulling the rear seat window button.

Rear seat window lock function

This function locks the window so that it cannot be opened and closed from the rear seats.

Press the Rear seat window lock button.



Warning

- **If a small child is seated in the rear seat, be sure to press the Rear seat window lock button to make the Window buttons inoperative. It can prevent an accident caused by the child's mischief.**

What is wind buffeting?

Wind buffeting is the phenomenon when you feel pressure upon your ears or hear some noises such as the sound of a helicopter when you drive the vehicle with a rear seat window or the sunroof opened to a certain position.

This phenomenon occurs when air flows in through the rear seat window or the sunroof, creating resonance.

If you adjust the open space of the rear seat window or the sunroof when the wind buffeting occurs, such phenomenon disappears or is reduced.



Warning

- **While driving or stopping, do not hold a part of your body such as your hand or head out of the window. You may get injured by a passing vehicle or an outside obstacle.**
- **Be careful not to get a part of your body such as your hand or head to be caught in the window when operating the window.**



Caution

- **Operating a number of Window buttons at the same time may damage the fuse that is the over-current protective device or the window system.**
- **Operating the Window buttons on the driver seat door and a different door in the opposite direction at the same time may damage the window system.**

The sunroof is a secondary window installed on the vehicle roof for supporting pleasant driving such as ventilation and lighting in the vehicle.

The sunroof window can be slide opened and closed and it also operates in a tilting way to lift the rear section of the sunroof up slightly.

The sunroof cover can be opened and closed by hand.



Warning

- While driving or stopping, do not hold a part of your body such as your hand or head out of the sunroof. You may get injured by a passing vehicle or an outside obstacle.

Caution

- The sunroof operates even when the START/STOP switch is in the ON status. However, caution should be taken that using the sunroof excessively while the engine is not running may cause depletion of the battery.
- After finishing the sunroof operation, release the Control button. Pressing the Control button continuously may cause a malfunction.
- If the sunroof is opened completely, the wind buffeting may become intensified. In such case, adjust the open space in the sunroof.
- If the sunroof operation part is frozen during winter, operate it after the frozen part melts completely.
- Remove dust and foreign materials from the rubber part around the sunroof window periodically. If dust and foreign materials are present, noise may occur when the sunroof operates and it may cause a malfunction.

Notice

- To operate the sunroof, the START/STOP switch should be in the ON status or the engine should be running.

Opening the sunroof

Opening automatically

Press the sunroof open button briefly. The sunroof opens automatically.

The rear part (6cm) of the sunroof will not open.

To open the sunroof fully, press the sunroof open button again.



Notice

- Operating the switch while the sunroof is opening stops the sunroof operation.

Opening manually

Press and hold the sunroof open button. The sunroof will only open while the open button is pressed.

To open the sunroof fully, you must keep the open button pressed.

What is wind buffeting?

Wind buffeting is the phenomenon when you feel pressure upon your ears or hear some noises such as the sound of a helicopter you when you drive the vehicle with a rear seat window or the sunroof opened to a certain position.

This phenomenon occurs when air flows in through the rear seat window or the sunroof, creating resonance.

If you adjust the open space of the rear seat window or the sunroof when the wind buffeting occurs, such phenomenon disappears or is reduced.

Closing the sunroof

Closing automatically

Press the sunroof close button briefly. The sunroof closes automatically.



Notice

- Operating the switch while the sunroof is closing stops the sunroof operation.

Closing manually

Press and hold the sunroof close button. The sunroof will be closed only while you are pressing the close button.

In order to close the sunroof fully, you have to keep pressing the close button.

Tilting the sunroof up/down



Tilting up (opening the rear section)

With the sunroof closed, pull the Sunroof button. The rear section of the sunroof will open.

Tilting down (closing the rear section)

With the rear section of the sunroof opened, press the Sunroof button. At this time, the sunroof closes only while the button is being pressed.

To close the sunroof completely, you should press and hold the button.

Sunroof open warning

When you place the START/STOP switch in the ACC or OFF position and open the driver seat door with the sunroof opened, the sunroof open warning buzzer will sound.

When you close the door, the warning buzzer will be turned off.

When the sunroof open warning buzzer sounds, leave the vehicle after closing the sunroof completely.



Caution

- When leaving the vehicle, check if the sunroof is closed completely. Leaving the vehicle with the sunroof opened may cause a robbery case through the sunroof. Also, the inside of the vehicle may get wet when it rains or snows.

Sunroof safety function

The sunroof safety function controls the sunroof to open without closing from its position for safety when it is recognized that a body part or an object is caught in it when the sunroof is closing automatically.



Caution

- The sunroof safety function is not activated for the last section of the sunroof to be closed.
- The sunroof safety function is just an auxiliary system and it is no substitute for the driver's attention. Always exercise caution since it may not operate according to an electrical device or other situations.

Resetting the sunroof

Cases requiring the resetting of the sunroof

- When the battery is depleted or the power supply is suspended with the sunroof opened
- When the sunroof does not open or close completely by operating the button once
- When the sunroof is tilted without stop after it is closed in the sliding method
- When the moving distance has decreased significantly when sliding or tilting the sunroof
- If the sunroof does not operate or operates abnormally when the Sunroof button is pressed

Resetting

With the sunroof tilted up (opening the rear section), pull the Sunroof button continuously for approximately 20 seconds.

- A clicking sound occurs once approximately 5 seconds later and once again approximately 20 seconds later after pulling the Sunroof button. The sunroof resets along with the second clicking sound.
- When you press the Sunroof button slightly after resetting, the sunroof opens and closes again automatically.



Caution

- **If the sunroof does not operate normally after resetting the sunroof, have your sunroof checked and serviced at a KG Mobility Corporation Authorized Service Center.**

The tailgate is a unit that increases the convenience in loading or unloading an article from the vehicle.

The power tailgate allows the user to open and close the tailgate using a simple button operation.

Also, the smart tailgate opens the tailgate automatically when a user approaches to the detection area at the back of the tailgate.



Warning

- Do not disassemble the manual and power tailgate support bars. It is composed of the high pressure devices, which may cause injuries.
- Do not apply heat the manual and power tailgate support bars. It may be damaged by heat and cause injuries.
- Do not dismantle the tailgate's gas lifter. It is composed of the high pressure devices, which may cause injuries.
- Do not heat the tailgate's gas lifter. It may be damaged by heat and cause injuries.
- In order to replace or dispose of the gas lifter, please visit our nearest KG Mobility Authorized Service Center.

Manual tailgate

Opening

- 1 Press the Tailgate open button on the inner side of the tailgate door handle while carrying the smart key.

The tailgate will be unlocked.

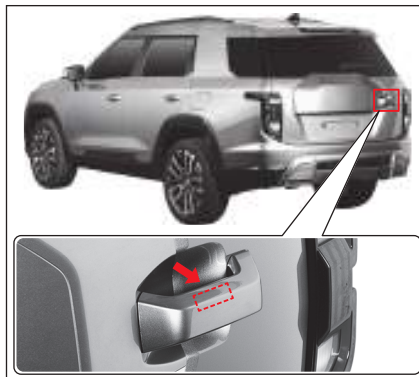

- 2 Lift the tailgate up.

Notice

- The range that the tailgate can recognize the smart key is within approximately 1 m.
- When you press the Tailgate open button, only the tailgate is unlocked. The door, engine hood and other devices remain locked.

Closing

- 1 Hold the inner handle of the tailgate and pull the tailgate down.



- 2 Close the tailgate by pushing it slightly.



Caution

- When the tailgate is opened and closed with the theft monitoring canceled, the mode is not switched to the theft monitoring mode automatically. Be sure to switch the mode to the theft monitoring mode by pressing the Door lock button on the smart key.

Notice

- When the tailgate is opened and closed in the theft monitoring mode, the mode returns to the theft monitoring mode automatically. At this time, the hazard warning lamp blinks twice and the warning buzzer sounds once.

Power tailgate*

The power tailgate is a unit that allows the user to open and close the tailgate using a simple button operation.

The power tailgate operates when the gear shift lever is in P (Parking) position with the START/STOP switch in the ON status or in all positions of the gear shift lever when the engine is turned off.

Notice

- If the vehicle speed is 3km/h or faster with the START/STOP switch in the ON status, the tailgate cannot be opened automatically.

Open/Close Tailgate With Interior Switch



- Touch and hold the interior switch for the tailgate.

After the hazard warning lamp blinks twice and the warning buzzer sounds twice, the tailgate opens or closes.

The tailgate opens if it is closed or it closes if it is opened.

Notice

- When you press the Tailgate button while the power tailgate is opening or closing, the tailgate stops on that position.
- The interior switch for the power tailgate remains visible even when the buttonless integrated control panel is switched off.

Opening/closing with the smart key



- Press and hold the Tailgate button on the smart key. After the hazard warning lamp blinks twice and the warning buzzer sounds twice, the tailgate opens or closes. The tailgate opens if it is closed or it closes if it is open.

Notice

- **When you press the Tailgate button while the power tailgate is opening or closing, the tailgate stops on that position.**

Opening/closing with the button on the tailgate

- Press the Tailgate outside button while carrying the smart key. After the hazard warning lamp blinks twice and the warning buzzer sounds twice, the tailgate opens.



Notice

- The range that the tailgate can recognize the smart key is within approximately 1 m.
- When you press the Tailgate outside button, only the tailgate is unlocked. The door, engine hood and other devices remain locked.

Press the Tailgate inside button with the tailgate opened.

After the hazard warning lamp blinks twice and the warning buzzer sounds twice, the tailgate closes.



Anti-pinch protection function

The anti-pinch protection function controls the tailgate to stop at that position or open completely for safety when a strong impact is received from the outside or a certain level of force is detected while the power tailgate is opening or closing.



Warning

- **The anti-pinch protection function may not operate if the resistance detected by the power tailgate is smaller than a certain level of force or the tailgate is in the position that it is almost closed.**
- **Do not place a part of your body or an article on the moving path of the tailgate on purpose in order to check the anti-pinch protection function during the power tailgate operation. Doing so may cause serious injury or article and device damage.**



Caution

- **If the anti-pinch protection function operates repeatedly for a number of times, close the tailgate manually and operate it again. If there is an abnormality, have your vehicle checked and serviced at a KG Mobility Corporation Authorized Service Center.**

Resetting the opening height

The maximum opening height of the power tailgate can be reset in accordance with the user's physical condition or other conditions such as the parking space.

- 1 Open the tailgate manually and adjust it to a desired height.
- 2 Press the Power tailgate inside button for 3 seconds or more.
When the resetting is completed, a beep sound occurs.
- 3 Close the tailgate completely by pressing the Power tailgate inside button.

When the opening height is reseted, press the Power tailgate outside button to see if the tailgate opens to the set position.

Resetting the power tailgate

If the power supply is reconnected after the battery is fully depleted or the power supply is disconnected or if the power tailgate does not function normally, reset the power tailgate.

- 1 Park the vehicle on a flat ground and shift the gear shift lever to the P (Parking) position.
- 2 With the Tailgate inside button pressed, press and hold the Outside button for 3 seconds or more.
When the resetting is completed, a beep sound occurs.
- 3 Close the tailgate completely by hand.

When the resetting is completed, check that the power tailgate opens and closes normally.



Caution

- Do not operate the power tailgate in any of the following cases since it may malfunction.
 - When one wheel of the vehicle is lifted up for vehicle check or tire replacement
 - When one wheel of the vehicle is in the air unevenly on a sloping road or paving blocks
 - When the vehicle is parked or stopped on a slope or an uneven surface
- The power tailgate operates even when the START/STOP switch is in the OFF status. However, caution should be taken that operating the power tailgate excessively with the START/STOP switch turned off may cause depletion of the battery.
- When you operate the power tailgate for 5 times or more consecutively, the warning buzzer sounds 3 times and the power tailgate stops in order to prevent the drive motor from being overheated. In such case, stop the operation of the power tailgate for 1 minute or longer and then operate the power tailgate again.

- Do not operate the power tailgate manually if possible.
- If it is necessary to operate the power tailgate manually since it does not operate normally, do not apply excessive force. Doing so may damage the power tailgate unit.
- Do not apply excessive force to the tailgate while the power tailgate is operating. Doing so may damage the power tailgate.
- If you close the tailgate immediately after opening it, the tailgate may not be closed. This is a normal operation. Close the tailgate after a short time interval.
- Do not attach a heavy object to the power tailgate. Doing so may damage the power tailgate.
- Do not modify or repair the power tailgate and relevant components arbitrarily.

Smart tailgate*

The smart tailgate is a function that opens the tailgate automatically when a user carrying the smart key approaches the detection area at the back of the vehicle. This is particularly convenient when you are carrying packages in both hands.

Activating/deactivating the smart tailgate

- You may enable this function at **User setting** → **Door / Tailgate** → **Smart Tailgate** under  (user settings) in the instrument cluster.

Notice

- You must enable the power tailgate to enable the smart tailgate.

Opening the smart tailgate

Operating condition

- The engine should be turned off and all doors and the tailgate should be in locked status (theft monitoring mode).
- You should stay in an area within approximately 1 m from the smart tailgate sensor at the back of the vehicle for approximately 3 seconds or more while carrying the smart key.

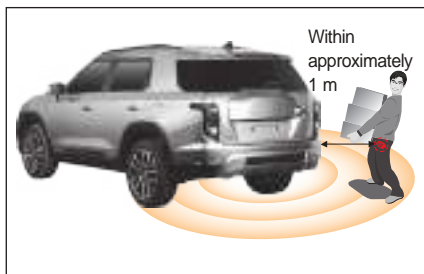

Operation step

The tailgate opens automatically in the following steps after the smart key is detected.



• Step 1

The hazard warning lamp and the warning buzzer sound three times at an interval of 1 second (beep~ beep~ beep~)

• Step 2

The hazard warning lamp and the warning buzzer sound three times (beep beep beep)

• Step 3

The hazard warning lamp and the warning buzzer sound two times (beep beep)

Next, the tailgate opens.

Stopping the smart tailgate function

- Press any button on the smart key.
- Or, get out of the detection area of the smart tailgate.

⚠ Caution

- The smart tailgate begins operating when 30 seconds have passed after entering the theft monitoring mode. This is for preventing the smart tailgate from malfunctioning.
- In any of the following cases, the smart tailgate operation may be delayed or the operating range may change due to frequency interference.
 - When you are in or near a facility where a strong radio frequency is emitted including a police station, government office, broadcasting station, military unit, transmitting tower, airport, harbor, etc.
 - When you carry the smart key along with a mobile phone or a radio set, etc.
- In any of the following cases, the detection range of the smart key may vary, affecting the operation range of the smart tailgate.
 - When one wheel of the vehicle is lifted up for checking the vehicle or replacing tires
 - When the vehicle is parked or stopped on a sloping road or an uneven surface

- Do not stay in the detection area of the smart tailgate unnecessarily while carrying the smart key.
- Familiarize yourself with how to deactivate and stop the smart tailgate function in preparation for an emergency as well as various other situations.
- Be sure to deactivate the smart tailgate function when you wash your vehicle. Failure to do so may cause the tailgate to open automatically, causing a personal injury or damage to the vehicle and other facilities.

Opening the tailgate in the event of emergency

You can open the tailgate using the unlock lever in the tailgate in the event of depletion of the battery, failure of the tailgate devices or other emergency situations.

- 1 Unfold the mechanical key of the smart key or REKES key.

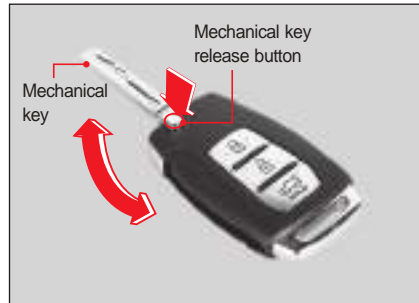

- 2 Insert the mechanical key into the unlock lever hole (1) at the bottom center.



- 3 Press the mechanical key in the direction of the arrow. It unlocks the tailgate.



- 4 Push open the tailgate.

3



Warning

- Only use the tailgate unlock lever in the event of emergency.
- Do not allow children to play in the luggage compartment. If the tailgate unlock lever operates, opening the tailgate suddenly while driving, a serious accident may occur.



Caution

- Familiarize yourself with the position of the tailgate unlock lever and how to use it in preparation for an emergency.



Warning

- Avoid driving the vehicle with the tailgate open.
 - Exhaust gas may flow into indoors, resulting in gas poisoning.
 - An article from the inside of the vehicle may fall out, causing an accident.
 - The tailgate or other vehicle parts may get damaged.
- Driving the vehicle at a speed of 4km/h or faster with the tailgate open, the tailgate open warning light turns on and the warning buzzer sounds 10 times. Move the vehicle to a safe place immediately and close the tailgate firmly.
- Open or close the tailgate after confirming the safety inside and outside of the vehicle. In particular, be careful not to get a part of an indoor occupant or a near-by person's body caught.
- Be careful not to allow a child to operate the power tailgate or smart tailgate by accident while carrying the smart key. Failure to do so may cause damage to a near-by person, article or vehicle, etc.

- Do not open the tailgate after parking or stopping the vehicle on a sloping road. Doing so may cause an article loaded in the vehicle to fall out, causing injury to a user.
- When you close the tailgate, the tailgate may close suddenly due to the weight of the tailgate and other external factors. Be cautious for preventing injury when closing the tailgate.

Engine hood

Opening the engine hood

- 1 Pull the engine hood open lever (1) located at the bottom left side of the driver seat.

The engine hood will be opened slightly.

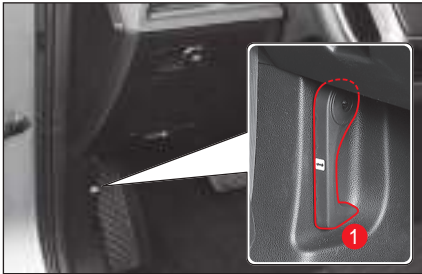

- 2 Lift the engine hood slightly to pull the engine hood latch lever (2) up and lift up the engine hood completely.

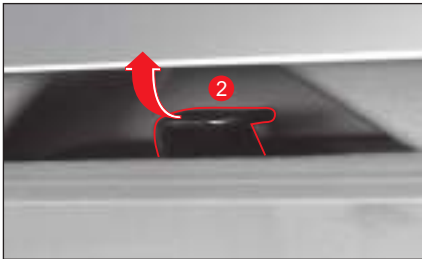

- 3 Lift the engine hood up.
When you lift engine hood half way, it will open to the end automatically.

Closing the engine hood

Checking before closing the engine hood

- Make sure that all inlet caps in the engine room are closed properly.
- Check that no unnecessary items including gloves and tools are left in the engine room.

Closing the engine hood

Pull the engine hood down and close it by pressing it down.

⚠ Caution

- If the engine hood is lifted slightly while it is closed, open the engine hood again and close it by pushing it with stronger force.
- The side garnish (A) mounted on the engine hood is a component for design purposes. Do not use side garnish for hanging ropes, hoops, etc. This may lead to damage to the side garnish and damage to the vehicle.



⚠ Warning

- Open the engine hood after turning off the engine. However, if you need to check and carry out services with the engine on, pay particular attention not to be injured by the operating devices in the engine room.
- Check the engine hood in a place where no wind blows. You may get injured if the engine hood is closed by wind.
- Be careful not to get any of your body parts such as fingers caught when closing the engine hood.
- Confirm that the engine hood is closed completely before driving. If you drive the vehicle with the engine hood open, the vehicle may get damaged and it may block the driver's vision, causing a serious accident.
- Do not disassemble the hood gas lifter. It is composed of the high pressure devices, which may cause injuries.
- Do not apply heat the hood gas lifter. It may be damaged by heat and cause injuries.
- When Replacing and disposing of gas lifter, have your vehicle serviced at a KG Mobility Corporation Authorized Service Center.

Fuel inlet

Opening the fuel inlet

The fuel inlet cover can be opened only when all doors are unlocked.

- 1 Shift the gear shift lever to the P (Parking) position.
(Place the shift lever in the N (Neutral) position for the vehicles with the manual transmission.)
- 2 Apply the parking brake.
- 3 Be sure to turn off the engine.
- 4 Push the center edge of the fuel inlet cover in the arrow direction.



Caution

- If the fuel inlet cover is frozen during winter, do not open it forcibly. Open it by gently tapping on the edge of the cover.

- 5 Open the fuel inlet cover completely by pulling it in the arrow direction.



- 6 Open the fuel inlet cap by turning it counterclockwise.



- 7 Hang the fuel inlet cap on the holder mounted inside the fuel inlet cover.



Warning

- Separate the fuel inlet cap carefully since pressure may be applied to the fuel. If you hear a sound of fuel leakage or deflation, wait until such sound stops and then separate the cap again. Failure to do so may cause fuel to emit, causing a serious injury.
- When you touch the fuel inlet cap or the gas pump, contact a metal part that is far away from the fuel inlet with bare hands first to remove static electricity. Failure to do so may cause a fire due to static electricity.

Closing the fuel inlet

- 1 Close the fuel inlet cap by turning it clockwise until a clicking sound occurs.
- 2 Close the fuel inlet cover by pushing the center edge of the fuel inlet cover.

Information - Fuel label

• PETROL TYPE OF FUEL



The shape for a petrol- type fuel is a circle ("E" stands for specific bio-components present in petrol)

Warning

- Be sure to refuel after stopping the engine. Failure to do so may cause vaporized fuel to ignite due to a spark generated from an electrical device when starting the engine, causing a serious fire.
- Keep any Inflammables such as a lighted cigarette or a lighter away during refueling. Failure to do so may cause a serious fire.
- Do not take an action that may generate static electricity such as getting in and out of the vehicle during refueling. Doing so may cause a serious fire due to static electricity.
- If it is necessary to refuel using a portable container, refuel with the container placed on the ground. Refueling with the container placed on top of or inside the vehicle may cause a serious fire due to static electricity.
- Be sure to refuel after checking the type of the fuel used. If you misfuel a vehicle using diesel or gasoline, the fuel system and other vehicle systems may be affected, damaging the vehicle significantly.
- Do not use fuel containing a lot of moisture, improper fuel or additives. Doing so may damage the fuel system and the exhaust gas system of the vehicle significantly.

- Refuel only until the pump nozzle of the fuel supply gun stops automatically. Filling the fuel tank excessively may cause fuel to overflow, causing a fire and damaging the vehicle body.
- Do not use a mobile phone near a gas station. Doing so may cause a fire due to an electromagnetic wave or current of the mobile phone.
- If a fire occurs while refueling, evacuate to a place far from the vehicle immediately. Then, take measures such as the reporting the fire.

Caution

- Be careful not to allow the fuel to contact the vehicle body as it can damage the painted surface.
- Be sure to use a genuine fuel inlet cap when it is necessary to replace it.

Lights and lamps

Outdoor lights/lamps

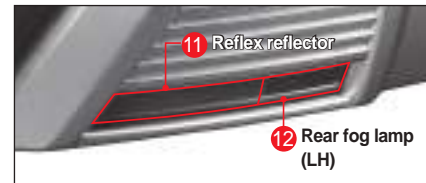
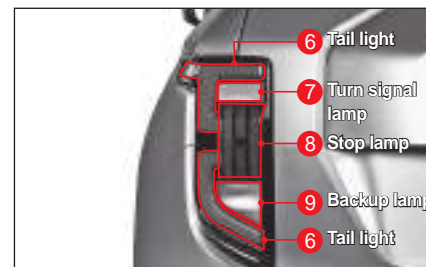
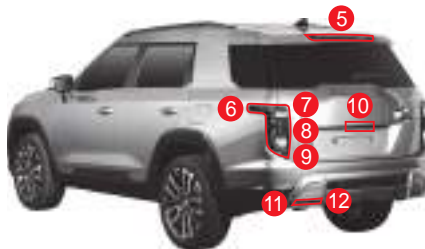
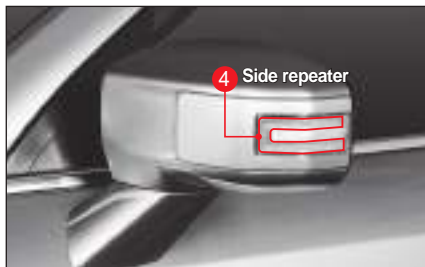
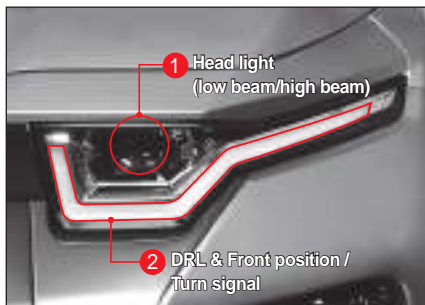

Light switch

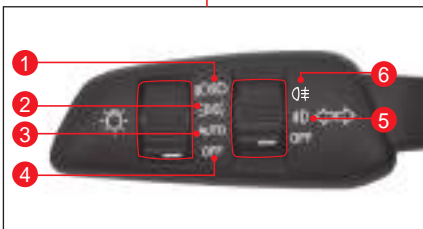

- 1 Head light
- 2 Tail light
- 3 Auto light function
- 4 Turning off all lights
- 5 Front fog light
- 6 Rear fog light

Turning on the head light

The head light turns on along with the sidelight, tail light, license plate lamp, front fog light (in the ON status) and other interior lights.

Turning on the tail light

The tail light turns on along with the sidelight, license plate lamp, front fog light (in the ON status) and other interior lights.

AUTO Activating the auto light function*

The head light and the tail light turn on or off automatically according to the amount of sunshine received by the auto light sensor.

Turning on Smart High Beam Assist (SHB)

Pushing the Light switch in the direction of instrument cluster with the Light switch in the AUTO position activates the SHB.

* Refer to "Smart High Beam (SHB)" (p.3-41)

OFF Turning off all lights

All lights turn off.

Notice

- For the vehicles without the auto light and fog lamp, the light switch has no corresponding function.

Turning on the front fog light*

When you place the Light switch in the  (front fog light) position with the head light or the tail light on, the front fog light turns on.

Turning on the rear fog light*

With the headlights turned on, if you rotate the switch in  position, rear fog lights turn on and the switch returns back in front fog light position. Rear and front fog lights turn on simultaneously. Turning it again will turn off the rear fog lamp.

OFF Turning off the fog light*

The fog light turns off.

Turning on/off the left/right turn signal



- When you push the Light switch down (1), the left turn signal blinks. At this time, the turn signal on the instrument cluster also blinks.
- When you push the Light switch up (2), the right turn signal blinks. At this time, the turn signal on the instrument cluster also blinks.

Turning on/off the high beam



- When you push the Light switch in the direction of instrument cluster and release it with the low beam on, the high beam turns on. At this time, the high beam indicator on the instrument cluster also turns on.
- When you pull the Light switch in the driver's direction and release it with the high beam on, the high beam turns off.

Warning

- **Do not turn on the high beam if there is an oncoming vehicle or a vehicle at the front. The high beam may block the other drivers' vision, causing an accident.**

Turning on the high beam and low beam at the same time (passing light)



The high beam and the low beam turn on at the same time while pulling the Light switch in the driver's direction.

Notice

- **This function operates regardless of the position of the Light switch.**

Hazard warning lamp

The hazard warning lamp is used to give warning to other vehicles in the event of emergency for preventing an accident.

- When you press the Hazard warning lamp switch, all turn signals blink.
- When you press the Hazard warning lamp switch again, the hazard warning lamp turns off.

 Refer to "Emergency Stop Signal (ESS)" (p.4-138)

Caution

- **Do not operate the hazard warning lamp for a long period of time with the engine off. Doing so may cause confusion to other vehicle drivers as well as depletion of the battery.**

Notice

- **The hazard warning lamp operates regardless of the status of the START/ STOP switch**
- **While the hazard warning lamp is operating, the turn signal does not operate independently.**

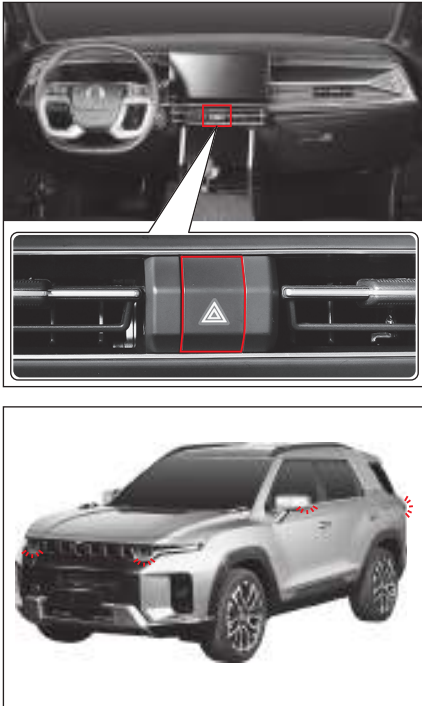

Adjusting the angle of the head light

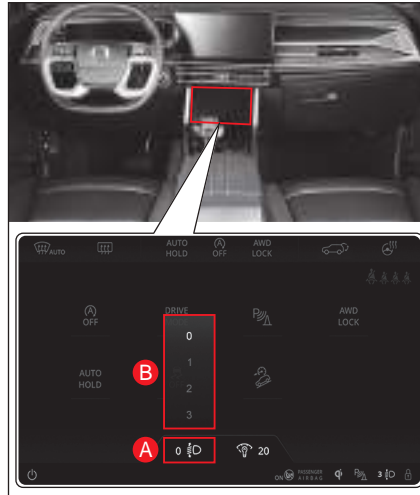

Angle adjustment levels of the head light

The angle of the head light can be adjusted in 4 levels (Levels 0–3) according to the front and rear slope of the vehicle.



- When the vehicle is tilted forward Lower the head light angle adjustment dial (Level 0 direction). The head light is adjusted to face up.
- When the vehicle is tilted backward Raise the head light angle adjustment dial (Level 3 direction). The head light is adjusted to face down.

The front and rear slope of the vehicle may vary depending on the number of occupants, weight and center of gravity of luggage.

In such case, you can adjust the angle of the head light to secure proper vision at night and not to obstruct an oncoming vehicle or a vehicle at the front with a strong light from the head light.

Touch the headlamp aiming switch (A) lightly and touch the angle for each step to secure proper night vision and make sure that the driver of the facing or leading vehicle is not disturbed by the strong light of the headlights on your vehicle.

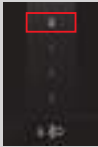
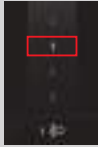
Angle adjustment standard for the head light

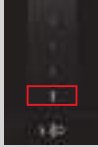
	Number of occupants and loading condition
Level 0 	<ul style="list-style-type: none"> 1~2 occupants (normal driving)
Level 1 	<ul style="list-style-type: none"> 1~2 occupants and luggage (approximately 90 kg) 4~5 occupants
Level 2 	<ul style="list-style-type: none"> 4~5 occupants and luggage (approximately 100 kg)
Level 3 	<ul style="list-style-type: none"> 1 occupant and luggage (approximately 400 kg)



Warning

- Drive the vehicle after adjusting the angle of the head light according to the number of occupants, weight and center of gravity of luggage. Failure to do so may cause an accident.
 - Never drive the vehicle in any of the following cases that go beyond the angle adjustment standard for the head light.
 - Driving the vehicle with level 3 under the condition of level 0 (the angle of the head light is lowered): It takes longer for the driver to recognize an emergency situation on the road ahead if it occurs.
 - Driving the vehicle with level 0 under the condition of level 3 (the angle of the head light is raised): It obstructs the vision of the driver in an oncoming vehicle or a vehicle at the front.
- In such case, it may obstruct safe driving, causing a serious accident.

Daytime Running Light (DRL)*

The DRL also turns on automatically during daytime, allowing you to recognize a vehicle easily.

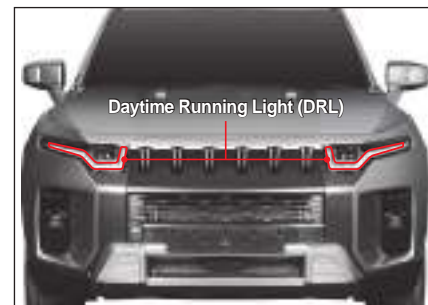

In case the DRL turns on

- If the switch of the tail light, front fog light and head light is not operated with the START/STOP switch in the ON (irrelevant to whether the engine is started or not) status

Notice

- When the DRL turns on, the tail light also turns on at the same time.
- The same lamp is used for the DRL and the tail light, but the DRL is more bright.

In case the DRL turns off

- When the START/STOP switch is in ACC or OFF status
- When you turn on the head light or the head light is turned on by the auto light function
- When you turn on the front fog light
- When parking brake (EPB) applied at the vehicle speed of 3 km/h or less (AUTO HOLD switch turned off)
- When the hazard warning indicator is activated
- When the left / right turn signal indicator is activated

Smart High Beam (SHB)*

The SHB is the function to control the high beam not to obstruct the vision of a driver in an oncoming vehicle or a vehicle at the front with a strong light from the high beam.

The SHB detects the situation through the sensor at the top of the vehicle windshield (front camera module) and turns on or off the high beam automatically.

Setting the SHB

- 1 Place the Light switch in the AUTO position.



- 2 Push the Light switch in the direction of instrument cluster and release it.



- When the SHB function is activated, the SHB indicator turns on.



SHB indicator

In case the high beam turns on

All the following conditions are set with the SHB activated, the high beam turns on.

- When the vehicle speed is 35 km/h or faster
- When the surrounding area is dark that it is detected as night
- When an oncoming vehicle and a vehicle at the front are not detected

When the light beam turns on automatically, the SHB indicator turns on along with the high beam indicator.



SHB indicator



High beam indicator

In case the high beam turns off

The high beam turns off in any of the following cases.

- When the head light of an oncoming vehicle (including a bicycle and a motor cycle) is detected
- When the tail light of a vehicle (including a bicycle and a motor cycle) at the front is detected
- When it is bright in the surrounding area due to streetlights or other lighting sources in the surrounding roadside.
- When the light source of a tunnel is detected
- When the Light switch is not in the AUTO position
- When the SHB function is deactivated
- When the vehicle speed is less than 25 km/h

Notice

- **When the high beam turns off and then turns on again automatically, there may be a delay time for few seconds.**

Operating the Light switch

The detailed operation of the Light switch with the SHB set and activated is as follows.

- When you push the Light switch in the direction of the instrument cluster with the SHB set and operating, the high beam turns on and the SHB setting is canceled.
- When you pull the Light switch in the driver's direction with the SHB set, the high beam turns on and the SHB setting is maintained only while pulling the Light switch.
- When you pull the Light switch in the driver's direction while the SHB is operating, the high beam turns off and the SHB setting is canceled.
- When you place the Light switch in positions other than the AUTO position, the SHB setting is canceled.



Caution

In any of the following cases, the SHB may not operate normally.

- When the vehicle windshield is damaged or contaminated by dust, mist, fog, sticker, snow, etc
- When the lamp of an oncoming vehicle or a vehicle at the front is damaged
- When an oncoming vehicle or a vehicle at the front is out of your front sight
- When an oncoming vehicle and a vehicle at the front are recognized only partially in an intersection or a winding road
- When there is a light source similar to a vehicle lamp or a reflector at the front
- When an illuminator or a reflector is installed in a construction section, etc.

AUTO Approach

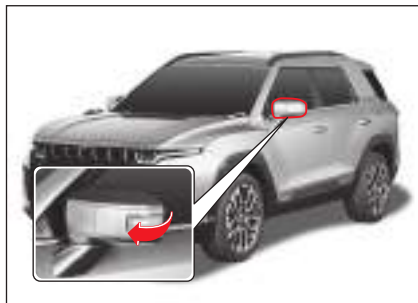

AUTO approach (outside rearview mirror unfolded) is activated when you are approaching within 1 m of the vehicle while carrying the smart key in theft deterrent mode.

Notice

- You may enable this function at **User setting** → **Convenience** → **Approach Welcome or Auto Approach Welcome** under  (user settings) in the instrument cluster.

In case the auto approach lamp turns off

In any of the following cases, the auto approach lamp turns off.

- When approximately 30 seconds have passed after the auto approach lamp turns on
- When the START/STOP switch is in the ON position
- When the vehicle enters the theft monitoring mode
- When the smart door auto lock is activated

Notice

- **The auto approach lamp operates up to 2 times within 10 minutes.**
- You may enable this function at **User setting** → **Convenience** → **Approach Welcome or Auto Approach Welcome** under  (user settings) in the instrument cluster.

Coming home/living home light

The coming home/living home light is the function that turns on the head light automatically when the vehicle arrives or leaves in dark environments, increasing the safety and convenience.

Setting the coming home/living home light

- Select **User setting** → **Light** → **Coming home headlamp or / Living home headlamp set time** (time for which the light comes on) under  (user settings) in the instrument cluster.
(Disable, 10 sec, 20 sec and 30 sec)

Operating the coming home light

- When you turn off the engine with the head light (low beam) on, the head light (low beam) stays on for the set duration.
- When a certain amount of time has passed with all doors and the tailgate closed, the head light (low beam) turns off.

Notice

- If you maintain the door or the tailgate opened within the set time after turning off the engine, the head light (low beam) turns off after 3 minutes.
- When you open and close the door or the tailgate within the set time after turning off the engine, the head light (low beam) stays on for the set time and then it turns off.
- When you place the Auto light and Head light (low beam) switches in the OFF position, the head light (low beam) turns off immediately.

Operating the living home light

- When you cancel the theft monitoring mode by pressing the Door unlock button on the smart key or the Door handle switch, the head light (low beam) stays on for the set time.
- When the set time has passed, the head light (low beam) turns off.

Notice

- When you press the Door lock button on the smart key with the living home light on, the head light (low beam) turns off and the vehicle enters the theft monitoring mode.
- When you place the START/STOP switch in the ON position with the living home light on, the head light (low beam) turns off immediately.

Auto light function*

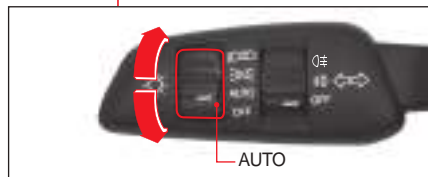

The auto light is the function that detects the amount of sunshine through the sensor and turns on or off the head light and the tail light automatically.

- The auto light function is activated when the Light switch is positioned in the AUTO position.

Auto light sensor



The auto light sensor is integrated with the rain sensor.



Caution

- When you shake or apply an impact to the auto light sensor, the auto light may malfunction.
- Do not wipe the auto light sensor installation part with cleaning agents or wax, etc. The auto light function may malfunction.
- Attaching commercially available window coating or tinting products to the windshield may cause the auto light function to malfunction.
- If the vehicle vibrates significantly just as driving on a road with an uneven surface, the auto light function may malfunction.

- The time to turn on and off the light may vary depending on a change in the climate condition such as fog, snow and rain and surrounding environment.
- When you change the Light switch to the AUTO position or from the AUTO position to another position, the lights inside the vehicle, tail light and head light may blink momentarily. This is a normal phenomenon for recognizing the status of the auto light.
- When passing through a dark place such as a tunnel, do not depend on the auto light function and turn on the head light manually.
- Use the auto light function for the head light and the tail light limitedly only at the time of sunrise and sunset. In general, operate the head light and the tail light manually.
- Do not use the auto light function for the head light and the tail light on a gloomy day. Operate such lights manually.

Interior lamp

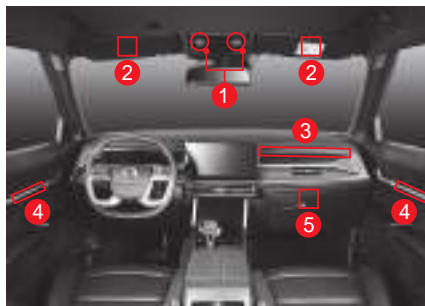
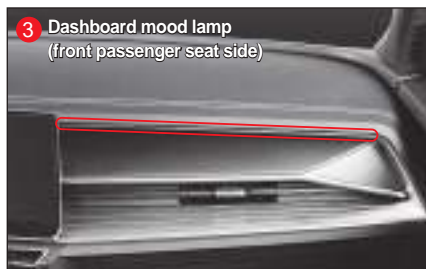
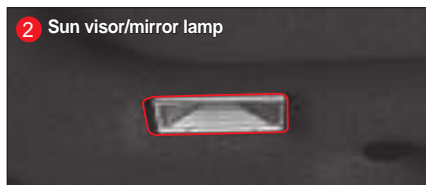

Front room lamp (overhead console)

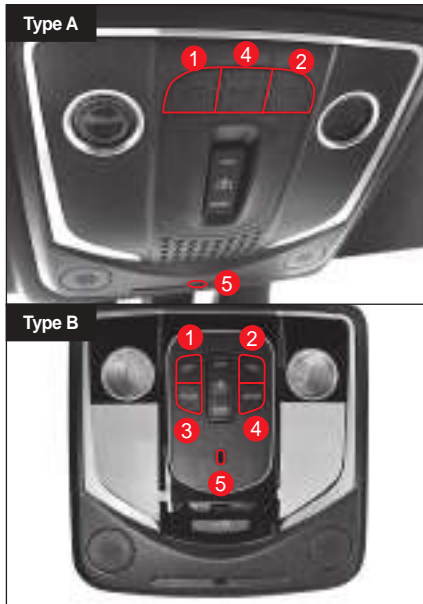

- 1 Driver seat spot switch
- 2 Front passenger seat spot switch
- 3 Driver/passenger/center room lamp/spot switch
- 4 Door-linked switch
- 5 Front spot lamp

Warning

- Avoid using the interior room lamp when driving at night or in a dark place. The light of the interior room lamp may obstruct the front vision of a driver, causing an accident.

Notice

- When the interior room lamp is turned on after the engine is turned off, the room lamp turns off automatically after approximately 10 minutes in order to prevent depletion of the battery.

Driver seat spot switch

When you press the switch (1), the driver seat front room lamp turns on.

Front passenger seat spot switch

When you press the switch (2), the front passenger seat front room lamp turns on.

Driver / passenger / center room lamp spot switch

When you press the switch (3), the driver / passenger / center room lamp turns on.

Door linkage switch

When you open the door with the switch (4) pressed, the front room lamp and the center room lamp turn on, and when you close the door, those lamps turn off.

Front spot lamp (5)

It illuminates when the tail lamp is turned on. It illuminates the front center area dimly. (Comes on only when sunroof is selected)

Linkage function between the smart/rekes key and the front room lamp

When you unlock the door using the smart/rekes key with the front room Lamp door linkage switch pressed, the driver seat and front passenger seat room lamps turn on for 30 seconds.

At this time, when you lock the door by pressing the Door lock button on the smart/rekes key, the driver seat and front passenger seat room lamps turn off immediately.

Caution

- Do not leave the door open for a long time with the room lamp linked to the door or leave the vehicle when the room lamp is turned on. If the room lamp stays on for a long period of time, the battery may be depleted.

Center room lamp



Pressing the center room lamp switch turns on the center room lamp. Pressing the switch again turns off the center room lamp. The center room lamp comes on when the door is opened regardless of the center room lamp switch operation if the door coupled switch is pressed in.

Caution

- Do not open the door for a long period of time with the Door linkage switch pressed. If the center room/luggage room lamp stays on for a long period of time, the battery may be depleted.
- Do not leave the tailgate not closed completely for long period of time. If the center room/luggage room lamp stays on for a long period of time, the battery may be depleted.

Luggage room lamp



- Pressing the switch (1) turns on the lamp and pressing it again turns it off with the tailgate open. (self-return type)
- When you close the tailgate with the luggage compartment lamp on, the luggage compartment lamp goes off.

Sun visor/mirror lamp

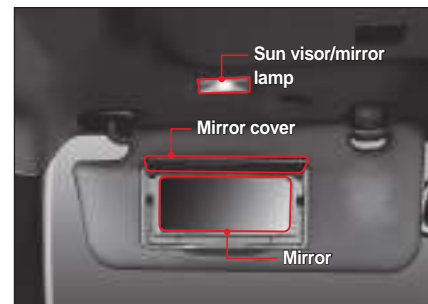

When you pull the sun visor down and open the mirror cover, the lamp turns on.

When you close the mirror cover, the lamp turns off.

Caution

- Be sure to close the mirror cover after using the sun visor mirror. Failure to do so may cause the sun visor lamp to stay on and the battery may be depleted. Also, an open mirror cover may cause injury.

Notice

- When you pull the sun visor down and use it as a sunshade, you can adjust the position of the sun visor.

Glove box lamp



When you open the glove box, the lamp turns on, and when you close the glove box, the lamp turns off.



Caution

- Leaving the glove box opened may cause injury to an occupant in the event of an accident or sudden braking. Be sure to drive the vehicle with the glove box closed.

Mood lamp*

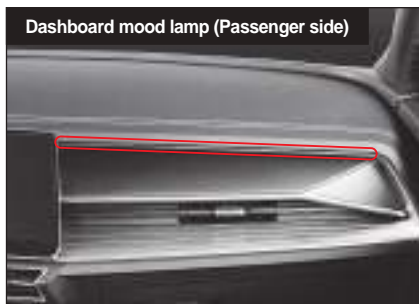

- When the mood lamp is set to enabled, the mood lamp is always lit if the engine is started or the ignition switch is turned on.
- When the tail lamp is turned on, the mood lamp gets dim and gives out a soft light.

Mood lamp setting

- 1 Press the MODE button on the smart audio.
- 2 Press the setting icon on the MODE menu.
- 3 Press the Vehicle Interlock.
- 4 You may select one of six colors and choose auto change or manual color.
- 5 Scroll down to the bottom of the room lamp selection screen to see following additional settings menu:
 - ON/OFF
Turn on and off the entire interior mood lamps.
 - Daytime OFF
Disables in the daytime.

e-call (Emergency call)*

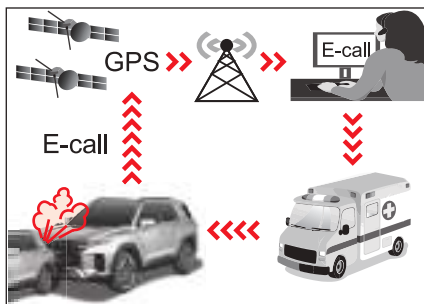

1. Accident occurs
2. Wireless network
3. Call center (PSAP)
4. Emergency center

The e-call is a system to minimize casualties by enabling the relevant information to be passed on to the nearest control center automatically or manually so that immediate action can be taken in case of traffic accidents and emergencies.

- SOS button: When the driver or passenger press this button, e-call is made to the service associate at the PSAP center.
- Test button (Russia only): This button is used to check the system performance. The driver should not press the Test button arbitrarily to activate the test mode.

Notice

- **The Test button is the button to enable the test mode, which is used only by experts for the KG Mobility Authorized Service Center to check system performance.**

- LED indicator: When turning the ignition on, the red and green LEDs light up for 3 seconds. Then, this LED will go off during normal operation. In the event of an issue with the system, the red LED lights up or blinks.

Caution

- If the red LED is still lit under normal driving conditions, it may indicate a malfunction of the E-CALL system.
- Contact the nearest authorized KG Mobility Dealer immediately to determine whether the E-CALL system is faulty or not.
- Otherwise, normal operation of the E-CALL system is not guaranteed. The vehicle owner is responsible for the consequences of not observing the instruction above.

How to use E-CALL system

AutoCall Mode



The ERA-GLONASS (eCall) device automatically makes an emergency call to a single duty dispatcher service for the timely implementation of rescue operations in the event of a car accident.

For the timely provision of assistance and support, the ERA-GLONASS (eCall) system automatically transmits data on a traffic accident to a single duty dispatcher service.

In this case, the emergency call cannot be terminated by pressing the SOS button, and the ERA-GLONASS (eCall) system remains in the connected state until the Unified Duty Control Service operator receiving the call disconnects the emergency call.

Notice

- In cases of insignificant cost of accidents, the ERA-GLONASS (eCall) system may not make an automatic emergency call. In this case, it is possible to make an emergency call in manual mode by pressing the SOS button.

Notice

- The operation of the system will be impossible if there is no coverage of mobile communication networks and no GPS and GLONASS signal. (In Case of EU : Galileo Added)

Manual Mode



The driver / passenger can make an emergency call in single dispatch service manually by pressing the SOS button to call emergency services.

Call to the emergency service using the ERA-GLONASS system can be canceled by pressing the SOS button again only before establishing a connection with the operator of the single duty-dispatch service. (Russia)

Call to the emergency service using the eCall system can be canceled by re-pressing the SOS button within 3 second. (EU)

After activating an emergency call in manual mode for timely assistance and support system ERA-GLONASS (eCall) transmits data on a traffic accident / other incident to the operator of the single duty dispatcher service during a call for help by pressing the SOS button.

- Stop your vehicle at a safe place.
- Lower the e-call button cover.
- Press the SOS button. (Minimal data set for the vehicle and its location is registered to the mobile network)
- The call is connected to the operator at the e-call center.
- EU: MSD (Minimum Set of Data) sent before the emergency call is made, not after it does

- Russia: MSD (Minimum Set of Data) sent before the emergency call is made, not after it does
- EU: For the manual emergency call, you can cancel within 3 seconds after pressing the button.
- Russia: You can cancel before the call is connected.

Test mode

- Russia: When you has replaced and checked the e-call system, you can use the Test button to activate the SOS test mode.

The driver should not press the Test button arbitrarily to activate the test mode.

There is a technical possibility device performance checks ERA-GLONASS installed on your car. In order to prevent erroneous signals anxiety and malfunctioning device, it is necessary to keep checking the device regularly ERA-GLONASS installed in the auto- mobile phone checks are allowed exclusively authorized to the staff in the service area in accordance with this manual (on enabling user testing interface). ERA-GLONASS device check mode is started by pressing a button. "Test Button". The test mode starts with voice guidance to verify performance device ERA-GLONASS. During the performance test of the ERA-GLONASS device, the red and green LEDs remain on. To deactivate the verification mode during the voice guidance output, it is not necessary to press the SOS test button again.



- EU: When you have replaced and checked the e-call system, you can use the scan tool to activate the SOS test mode.

e-call can't be canceled when:

- e-call is made automatically by crash signal from the air bag unit (terminated when an operator at e-call center ends the call)
- 3 seconds is elapsed since manual emergency call made by pressing the SOS button was connected (for EU)
- Operator at e-call center answers the call, for manual emergency call made by pressing the SOS button

Notice

- The battery of the ERA-GLONASS (eCall) system provides power for one hour in case the main power supply of the vehicle is turned off as a result of a collision in an emergency situation.

Notice (Russia only)

- During the operation of KG Mobility transported vehicles (commercial name Korando) in the territory of the Eurasian Economic Union (EAEU), incl. On the territory of the Russian Federation, with the installed UNIT ASSY-ECALL models, which include a multi-chip SIM / eUICC chip, the installation of additional profiles will be prohibited. And in this case, the packet transmission on these samples will be blocked.

Warning

I can be dangerous to remain in the vehicle, even if you have pressed the SOS button in an emergency if:

- you see smoke inside or outside of the vehicle, e.g. if there is a fire after an accident
- the vehicle is on a dangerous section of road
- the vehicle is not visible or cannot easily be seen by other road users, particularly when dark or in poor visibility conditions

There is a risk of an accident and injury. Leave the vehicle immediately in this or similar situations as soon as it is safe to do so. Move to a safe location along with other vehicle occupants. In such situations, secure the vehicle in accordance with national regulations, e.g. with a warning triangle.

Notice

1. Our eCall system provides 112-based eCall service only and conforms to the General Data Protection Regulation specified in EU laws.
2. Processing of such data is strictly limited to the purpose of handling the emergency eCall to the single European emergency number 112
3. Type of data and its recipients
 - MSD Data Items
 - 1) Call Type : Auto Call / Manual Call
 - 2) Test Call : Test Call / Emergency Call
 - 3) Position Can Be Trusted : Yes/No
 - 4) Vehicle Type : M1/M2/M3/N1/N2/N3
 - 5) Vehicle identification number
 - 6) Propulsion Storage Type : Gasoline, Diesel
 - 7) RTA event timestamp : Road Traffic Accident event timestamp
 - 8) Vehicle Location : Latitude, Longitude
 - 9) Vehicle Direction : Vehicle orientation at the time of event
 - Call Log Data Items
 - 1) Trigger time : Time of call initiation event (crash detected or button press).
 - 2) DTC : Diagnostic Trouble Code
 - 3) Tigger type : Manual Call / Auto Call / Retry Call
 - 4) RSSI : GSM(2G) or UMTS(3G) signal strength
 - 5) Ec/No : Energy Carrier/ noise power density
 - 6) Call type : GSM(2G) / UMTS(3G) / Reserved
 - 7) Call end status : Reason for call end

4. The 112-based eCall in vehicle system is designed in such a was as to :
 - Ensure that the data contained in the system memory is not available outside the system before an eCall is triggered
 - Ensure that it is not traceable and not subject to any constant tracking in its normal operation status
 - Ensure that data in the system internal memory is automatically and continuously removed
5. The vehicle's owner has a right of access to data and as appropriate to request the rectification, erasure or blocking of data, concerning him or her, the processing of which does not comply with the provisions of Directive 95/46/EC.
6. The data subject has a right to complain to the competent data protection authority if he or she considers that his or her rights have been infringed as a result of the processing of his or her personal data.

Windshield wiper

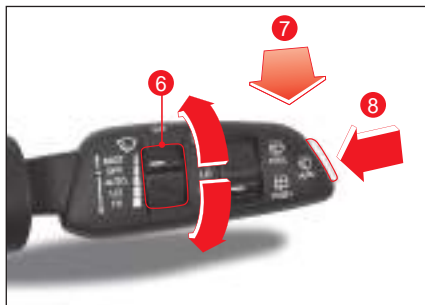
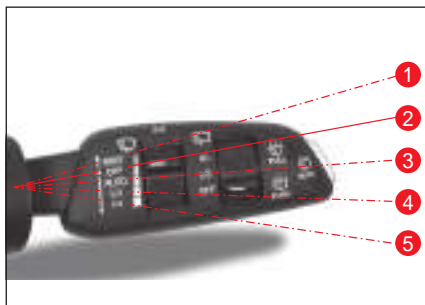

1 MIST

The wiper operates while lifting the wiper operation lever up.

When you release the lever, the level returns to the OFF position and stops.

2 OFF

The wiper stops operating.

3 AUTO

The wiper operation speed is adjusted automatically according to the vehicle speed or the amount of rain (rain sensing wiper).

4 LO

The wiper operates in low speed.

5 HI

The wiper operates in high speed.

Adjusting the operation speed of the windshield wiper

When the wiper operation lever is placed in the AUTO position, the operation speed of the wiper is adjusted.

When you lift the wiper operation speed control lever (6) up, the operation speed of the wiper becomes faster and when you pull the lever down, the operation speed of the wiper becomes slower.

Notice

- When you place the wiper operation lever in the AUTO position with the START/STOP switch in the ON status, the wiper operates once.
- When it becomes dark so that the auto light operates, the wiper speed becomes faster.

Front windshield and washer fluid linkage



This function sprays washer fluid automatically when the windshield wiper is operated.

It operates as follows according to the time to pull the wiper operation lever (7).

- Pull the lever for less than 0.6 second
The washer fluid is sprayed and the wiper operates once.
- Pull the lever for 0.6 second or more
The washer fluid is sprayed and the wiper operates for three times.
- Pull the lever continuously
The washer fluid is sprayed and the wiper operates continuously.

Front auto washer

With the wiper lever placed in the OFF position, press the Front auto washer switch (8).

The washer fluid is sprayed and the wiper operates for four times, and the washer fluid is sprayed again and the wiper operates for three times.

Rear window wiper

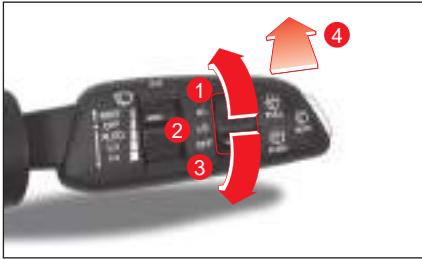

1 HI

The rear window wiper operates in high speed.

2 LO

The rear window wiper operates in low speed.

3 OFF

The rear window wiper stops operating.

Rear window wiper washer fluid linkage function



This function sprays washer fluid automatically when the rear window wiper is operated.

The washer fluid is sprayed and the wiper operates while pushing the wiper operation lever (4).

When you release the lever, the level returns to the OFF position and stops.

Rain sensing wiper*

The rain sensing wiper detects the amount of rain and controls whether or not to operate the windshield wiper and its operation speed automatically.

The rain sensing wiper is activated when the wiper operation lever is placed in the AUTO position.

Rain sensor



The rain sensor is integrated with the auto light sensor.

Warning

- When you place the wiper operation lever in the AUTO position with the START/STOP switch in the ON status, do not touch the windshield where the rain sensor is located or wipe it with damp cloth. Doing so may activate the rain sensing wiper, causing injury to your hand or other body parts.



Caution

- If the windshield is dry, do not only operate the wiper. Doing so may damage the windshield or the wiper blade. Be sure to activate the wiper after spraying the washer fluid.
- Before washing your vehicle, be sure to place the wiper operation lever in the OFF position. Failure to do so may activate the wiper by accident, causing body injury or damage to the vehicle.
- If it is not raining, place the wiper operation lever in the OFF position. It prevents the devices such as the rain sensor from operating unnecessarily.
- Activate the wiper in winter after verifying that the wiper blade is not frozen. Failure to do so may damage the windshield or the wiper blade.

Outside rearview mirror

Folding/unfolding the outside rearview mirror





- When you press the left side of the button (), the outside rearview mirror is unfolded.
- When you press the right side of the button (), the outside rearview mirror is folded.

Auto folding/unfolding function

The following is the function to fold or unfold the outside rearview mirror automatically.

- When the door Lock/Unlock button on the smart key is pressed
- When the door handle Lock/Unlock button is pressed
- When the smart auto door lock function is activated
- When the auto approach function is activated

Activating/deactivating auto folding/unfolding function

- Activating the function
Place the Outside rearview mirror folding/unfolding button in the neutral () position.
- Deactivating the function
Press the left side () or right side () of the outside rearview mirror.

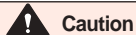



Caution

- **The outside rearview mirror auto folding/unfolding function is activated only when the vehicle has entered the theft monitoring mode.**

Adjusting the outside rearview mirror



- 1 Outside rearview mirror selection dial (L  R )
- 2 Outside rearview mirror control switch ()

Selecting the outside rearview mirror

Turn the selection dial (1) to the left or the right and select a mirror you wish to adjust.

- Turning to the left: The outside rearview mirror on the driver seat side is selected.
- Turning to the right: The outside rearview mirror on the front passenger seat side is selected.

Adjusting the angle of the outside rearview mirror

Adjust the angle of the mirror according to the driver's view by moving the Control button (2) up, down, left, or right.



Warning

- Do not tint the driver seat and the front passenger seat windows. Doing so may make the outside rearview mirror less visible while driving at night, causing an accident.



Caution

- The outside rearview mirror can be folded or unfolded for a certain period of time after the engine is turned off.
- Do not operate the mirror excessively after the engine is turned off. Doing so may cause depletion of the battery.
- Do not operate the mirror more than needed. When the mirror reaches its maximum adjustment angle, its movement stops, but the motor operates continuously while the switch is being pressed, causing the motor to malfunction.

- Do not operate the outside rearview mirror using hands instead of the motor switch. Doing so may cause the mirror and relevant devices to malfunction.
- Do not spray high pressure water directly onto the mirror while washing the vehicle. The outside rearview mirror operates electrically, so it may not operate normally due to an electrical device failure.
- If the mirror is frozen and does not move during winter, do not adjust it forcibly. Adjust the mirror carefully after removing ice by using deicing spray or soaking a soft cloth or sponge in warm water and wiping the frozen part with it.
- Do not scrape ice off even if the surface of the mirror is frozen during winter. Doing so may damage the surface of the mirror.

Interior mirror

The inside rearview mirror can be adjusted up, down or side ways to obtain the best rear view.

ECM room mirror*

The ECM (Electronic Chromic Mirror) room mirror detects a light from a following vehicle automatically through the light sensor and lowers the reflection rate of the mirror to prevent glare for the driver.

- To adjust the angle of the interior mirror, hold and move the body of the mirror with your hand up, down, left and right to obtain the best rear view.



Warning

- Be sure to finish adjusting the mirror before driving.
- Never adjust the mirror while driving. Doing so may distract the driver, causing an accident.
- If the interior mirror is broken, the electrolyte inside the mirror may flow out. Be careful not to allow this electrolyte come into contact with your skin or eyes. If the electrolyte comes into contact with your eyes, wash it with water immediately and consult a doctor.

Caution

In any of the following cases, the automatic anti-glare function of the ECM room mirror may not operate.

- If the head light of a following vehicle is not beamed directly to the light detection sensor
- When the rear window is tinted darker
- If the gear shift lever is in the R(Reverse) position

At this time, the automatic anti-glare function is suspended to enable easy identification of an object.

Manual type inside rearview mirror



The inside rearview mirror can be adjusted up, down or side ways to obtain the best view by holding the body of the mirror with your hand.

Manual Day/Night Adjustment (A)

You can manually adjust the rearview mirror by pushing or pulling its adjusting lever to avoid blindness at night due to other vehicles behind you.

Warning

- For your safety, adjust the mirror before driving off the vehicle.

Caution

- When you are not able to see the back of your vehicle at night, adjust the rearview mirror by holding the mirror body and pushing or pulling it to a desired angle so that you can secure a clear rear view.

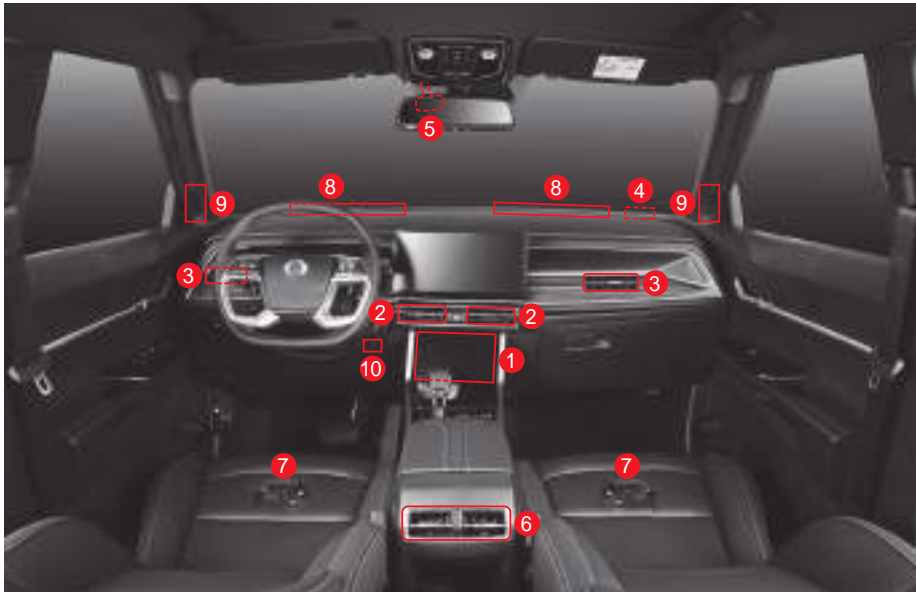

- 1 Heater and A/C controls(Buttonless integrated control panel)
- 2 Vents (front seat center)
- 3 Vents (both front seat sides)
- 4 Solar radiation sensor
- 5 Windshield fog detection sensor

- 6 Vent (rear seat center)
- 7 Rear foot duct (Bottom of front seat)
- 8 Center defroster vents
- 9 Side defroster vents
- 10 Interior temperature sensor

Adjusting the direction of air distribution and blocking the air distribution

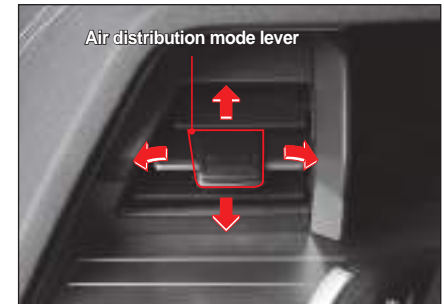

- Adjust air distribution
You can adjust the direction of air distribution by moving the air distribution mode lever up, down, left and right.
- Open and close air vents
If you push the air distribution mode lever all the way to the closing (☒) direction, the air vent closes and the air does not come out. If you put it in the opening (≡) direction, air comes out.

Caution

- Do not attach a cup holder or other devices to the air guide pin of the air outlet. Doing so may damage the air guide pin or other relevant devices.

Rear air distribution and fan speed control

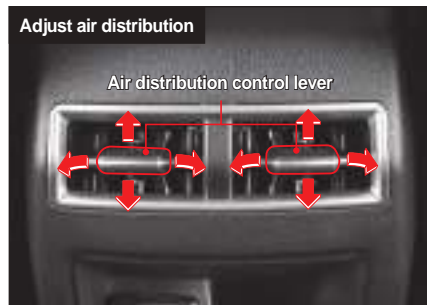

- You can adjust air distribution by moving the air distribution control lever at the vent up and down and left and right.

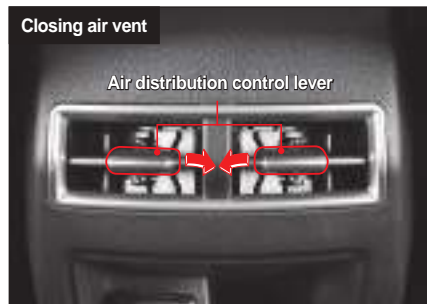

- You can close the air vent by pushing the air distribution control lever all the way in the direction of the arrow.

Cautions for using the heater and air conditioner

Replacing A/C refrigerant/oil

Be sure to replace the A/C refrigerant and oil with the products that meets the specified standard and capacity. Failure to do so may damage the air conditioner system.

Classification	Specifications	
	Type A	Type B
Standard	R-1234yf	R-134a
Refrigerant capacity	530 ± 30g	570 ± 30g
Oil capacity	120cc	120cc

Type A



Type B





Warning

- While driving, select the fresh air mode if possible or open the window and ventilate frequently to allow fresh air to flow in. Failure to do so may make the air inside the vehicle to be stuffy, causing headache or dizziness.
- Caution should be taken that if exhaust gas flows in, it may cause carbon monoxide poisoning.
- When you drive in an area where dust and smoke may flow in, pass the area using the recirculation mode and switch it to fresh air mode for ventilation.
- Do not sleep or stay inside the vehicle for a long period of time while operating the air conditioner or the heater with the doors and the windows closed during midsummer or midwinter. Doing so may cause suffocation due to lack of oxygen inside the vehicle.
- Never leave an infant, a small child or an elderly alone in the vehicle even for a short period of time during midsummer. The temperature inside the vehicle may increase, causing risks such as suffocation.
- Refrigerant is flammable which can cause the fire by the gas leakage or static, so be very careful when handling Refrigerant (R-1234yf).



Caution

- Before driving the vehicle, open all windows to ventilate the air inside the vehicle properly for the health of occupants and a pleasant indoor environment. Especially, if the vehicle has been parked on a place exposed to direct sunlight for a long period of time, the temperature inside the vehicle may have increased, causing volatile organic compounds that are harmful to human body to be emitted.
- Do not start the engine while electrical devices with high electrical load such as the air conditioner and fan are running. In such case, it may be difficult to start the engine and the engine idle speed becomes unstable after the engine is started so that you may feel vibration greater than usual.
- When you drive up on a long sloping road continuously, turn on and off the air conditioner every 3 to 5 minutes. Failure to do so may overheat the engine, causing a failure.
- When you apply a sudden acceleration while the air conditioner is operating, the magnetic clutch in the compressor is detached and may create a clicking sound. This is a normal operation that lowers excessive pressure of the refrigerant to protect the air conditioner system.

- Be sure to operate the air conditioner at a low speed if you use the air conditioner again after it is not used for a while. If the air conditioner is not used for a long period of time, the oil in the compressor is not circulated, causing a failure.
- When you use the air conditioner after it is not used for a long period of time, there may be a smell from the air outlet. In such case, open the window and operate the air conditioner for 20 to 30 minutes to eliminate the smell.
- Do not turn off the engine suddenly while operating the air conditioner. The fan motor stops suddenly and cold or warm air in the duct is condensed in the pipe without being emitted to the outside, creating a bad smell. Before turning off the engine, turn off the air conditioner and emit air in the duct for 2 to 3 minutes in the fresh air mode.
- Do not operate the air conditioner for a long period of time while stopping the vehicle. Doing so may overheat the engine, causing a failure.
- If the engine is not running, do not operate the fan for a long period of time. Doing so may cause depletion of the battery.
- Operate the air conditioner once a week in seasons other than winter to circulate the oil in the air conditioner compressor and relevant parts smoothly. This helps you to maintain the air conditioner in its best condition.

Heater & A/C Controls

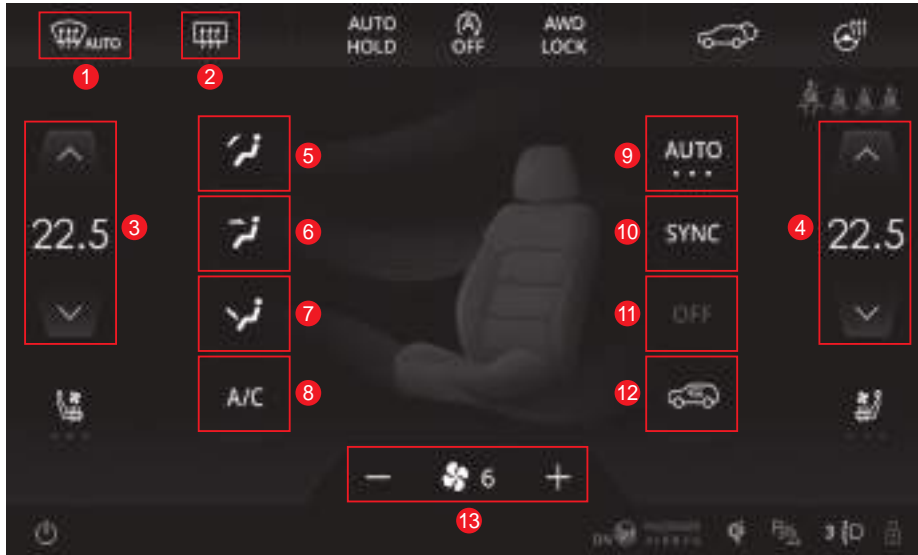

- 1 Defroster indicator (ADS)
- 2 Glass heater switch
- 3 Driver side temperature control switch
- 4 Passenger side temperature control switch
- 5 DEF mode air distribution switch
- 6 VENT mode air distribution switch
- 7 FOOT mode air distribution switch
- 8 A/C switch
- 9 AUTO switch
- 10 SYNC switch (to sync with driver side set temperature)
- 11 Heater and A/C ON/OFF switch
- 12 Air source selection switch
- 13 Fan Speed Control Switch

Turning Heater and A/C On/Off

To turn the heater and air conditioner on or off, lightly touch the OFF switch (1).

- Heater & A/C OFF: White symbol shown
- Heater & A/C ON: Gray symbol shown

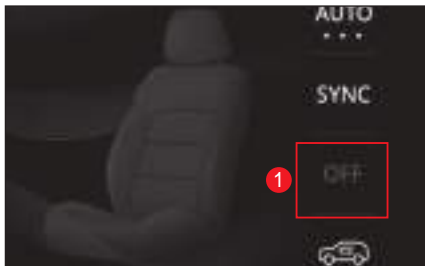

Notice

- The heater and air conditioner will operate as previous operation condition when they are turned on.
- When the heater and air conditioner are off, touch the relevant operation switch to turn them on.

Driver/Passenger Side Temperature Control

To adjust the temperature, lightly touch the driver/passenger side temperature control switch (1).

- The set temperature is indicated in the center of the temperature control switch (2).
- When the driver's seat set temperature synchronization (SYNC) indicator (3) is lit (white symbol shown), the driver's seat and the passenger seat's set temperature are changed equally.
- When the temperature control switch is operated, the increment values are:
 - 0.5°C on long touch.
 - 0.5°C on short touch.

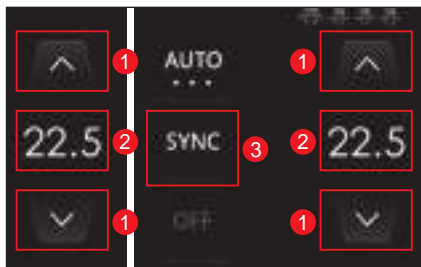

Notice

- Touching the AUTO switch in manual mode changes the climate control system to AUTO mode and the climate functions are controlled automatically based on the set temperature.

Independent Temperature Control (SYNC Off)

To independently adjust the set temperature for the driver's seat and front passenger's seat, operate as follows.

- Turn off the synchronization indicator (3) (gray symbol shown) by lightly touching the driver's seat temperature synchronization (SYNC) switch and the front passenger temperature control switch.
 - Synchronization indicator (SYNC) on: White symbol shown
 - Synchronization indicator (SYNC) off: Gray symbol shown

Temperature Synchronization Control (SYNC On)

Lightly touch the driver's seat set temperature synchronization (SYNC) switch to turn on the synchronization light (white symbol shown) (3). Then the set temperature of the passenger seat will follow the one of the driver's seat.

Notice

- Depending on the driver's seat set temperature, the air conditioner ON/OFF, air distribution, and air source mode are automatically set to:
 - Low temperature setting (LO): A/C ON, FACE mode, recirculation mode
 - High temperature setting (HI): A/C OFF, FOOT mode, fresh air mode

AUTO Mode

To enter AUTO mode, operate as follows with the engine started.

- Briefly touch the AUTO switch (1).
 - AUTO mode on: White symbol shown
 - AUTO mode off: Gray symbol shown
- Set the desired temperature by lightly touching the temperature control switch.

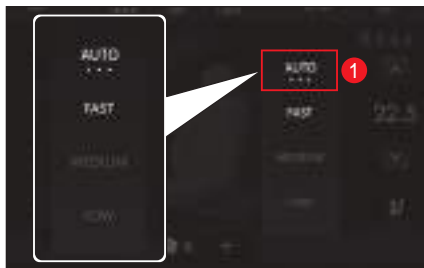

Notice

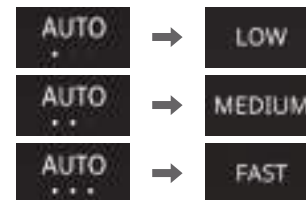

- In AUTO mode, the fan speed, air distribution and etc. are automatically adjusted according to the set temperature, room temperature, and outside temperature.
- Pressing the air source selection switch, fan speed switch, air distribution mode switch, A/C switch, or defroster switch in auto mode deactivates the auto mode and the system enters the manual mode.
- AUTO mode can be set in 3 steps.
- How to set AUTO mode
 - When you touch the switch briefly:
The setting is changed in order of FAST → MEDIUM → LOW → FAST.
 - When you touch and hold the switch:
A settings screen is displayed where you can select one of 3 levels (FAST / MEDIUM / LOW).
- The setting status is indicated by the dot(s) on the lower display bar.



Manual Mode

Operate as follows with the engine started.

- Touch the ON/OFF switch (1).
- Set the room temperature by lightly touching the temperature control switch (2).
 - The currently set temperature is displayed (3).
- Lightly touch the fan speed switch - (decrease fan speed) / + (increase fan speed) (4) to set the fan speed one step at a time.
 - The current fan speed is displayed (5).
 - The fan speed can be changed quickly from 0 to 8 by touching the fan speed indicator (5).
- Lightly touch the air distribution mode switch to select the desired air distribution mode. (You can select more than one air distribution mode.)
 - DEF mode (6) switch
 - VENT mode (7) switch
 - FOOT mode (8) switch

- Press the air source selection switch (9) to switch between the fresh air and recirculation modes.
 - Air recirculation mode: 
 - Fresh air mode: 
- To use the air conditioner, lightly touch the air conditioner switch (10).



Warning

- Do not use the recirculation mode longer than is needed. Doing so may cause headache or drowsiness due to lack of oxygen inside the vehicle. Also, moisture may occur on the window, impairing safe visibility and may result in an accident.
- Be careful not to allow exhaust gas to flow into the inside of the vehicle. Doing so may cause carbon monoxide poisoning.
- Pass an area where dust and smoke may flow in using the recirculation mode. After that, switch the mode to the fresh air mode for ventilation.

Notice

- When you press the AUTO switch in the manual mode, the mode changes to the AUTO mode, and each mode is controlled automatically according to the set temperature.

Air Distribution

Lightly touch the air distribution mode switch to select the desired air distribution mode. (You can select more than one air distribution mode and selected mode is indicated by a white symbol.)



DEF mode (1) switch

Blowing air in the direction of the windshield and door glasses (typical settings for defrosting and defogging)



VENT mode (2) switch

Blowing air in the direction of driver's and/or passenger's face (typical settings for cooling)



FOOT mode (3) switch

Blowing air in the direction of driver's and/or passenger's feet (typical settings for heating)

Notice

- When the air distribution is set to FOOT mode, some air is blown in the direction of the windshield and door glasses to prevent moisture buildup on the windshield.



Activating glass heater

When frost or fogging occurs in the window, the glass heater can be activated to remove it.

- To activate the glass heater, lightly touch the glass heater switch (1). (The glass heater operates for about 12 minutes and the symbol changes to orange.)
- To deactivate the glass heater, lightly touch the glass heater switch (1) again. (The glass heater stops working and the symbol changes to white.)

Rear window heater



Notice

- The glass heater only works when the engine is on.
- When the glass heater is activated, the rear window heater and the outside rearview mirror heater are operated simultaneously.
- If the glass heater is operated again within 10 minutes after completing operation for 12 minutes, it will only operate for approximately 6 minutes.

How to Dehumidify Window Glass

- 1 Lightly touch the defroster and defogger switch (1).
(The symbol changes to orange.)
- 2 Lightly touch the fan speed switch - (decrease fan speed) / + (increase fan speed) (2) to set the fan speed.
(The current fan speed is displayed (3).)
 - To quickly remove moisture from the windows, set the fan to high speed.
 - To defrost the outdoor side window, set the temperature to high.



Warning

- If it is raining or humid, switch the air source selection switch to the fresh air mode and set the air distribution to the windshield. With rainy or highly humid condition, fog may appear on the windows as well as the windshield even the A/C is ON. If this happens, it is dangerous to drive because of poor frontal and side visibilities.

Caution

- Avoid excessive use of A/C with the defroster and defogger turned on and the air distribution set to footwell or to footwell and the windshield. Otherwise, a temperature difference between indoor and outdoor may cause the fogging on the outside of the windshield. If this is the case, use the wiper blades to immediately clear fog on the windshield and change the air distribution mode to vent mode (toward face) to minimize the temperature difference.
- Make sure to remove any foreign materials such as snow and leaves on the air inlets to avoid window fogging, especially in winter and summer.

Notice

- Touching the defroster and defogger switch (1) activates the air conditioner automatically and sets it to fresh air mode and fan speed of 1st level or higher. Touching the switch again returns the system to previous condition.
- To prevent the windshield from fogging up normally, it is recommended to set the air source selection switch (4) to the fresh air mode.

Auto Defogger System (ADS)

In the InfoCon navigation system, ADS (Auto Defogger System) is an auxiliary device that enables safe driving by automatically removing fog when fog is detected on the indoor windshield while the heater and A/C are in operation. To use this function, you must enable the automatic defogger ("Check" under Vehicle Settings → Defogging → Auto Defogger).

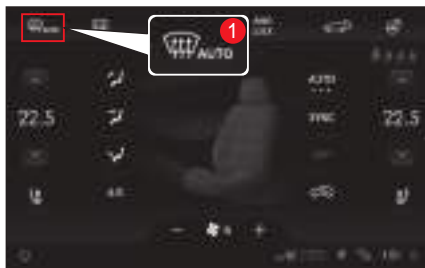

Operation levels of auto defogger system

As the humidity on the inside surface of windshield becomes higher, the auto defogger system operates at a high level. For example, if the humidity cannot be controlled by switching to the fresh air mode that is level 1, the operation is carried out from level 2 to level 4 in consecutive order to control the humidity.

- Level 1 - Switch to the fresh air mode
- Level 2 - Air conditioner ON
- Level 3 - Air distribution towards the windshield
- Level 4 - Increase the fan speed towards the windshield

Warning

- Do not switch the mode to the recirculation mode while the auto defogger system is operating. Doing so may decrease the moisture removal effect, impairing safe visibility and may result in an accident.
- Do not remove the sensor cover on top of the windshield forcibly. Doing so may damage the auto fog detection sensor.

Eco Mode

This is a function that maintains the air source selection mode to recirculation mode for 20 minutes when the vehicle is started, in order to quickly lower the vehicle's cabin temperature during hot weather.

Conditions for activation

- Air source selection: fresh air mode
- Ambient temperature: 24°C or higher
- A/C status: ON

Caution

- The vehicle enters eco mode only once upon starting, with the above operating conditions met.
- When the A/C is changed to the fresh air mode with the eco mode activated, the eco mode is deactivated.
- After 20 minutes of eco mode (recirculation mode) operation, the air source selection changes to the state before eco mode is activated.

Activating glass heater

Switch Between Buttonless Integrated Control Panel Screens

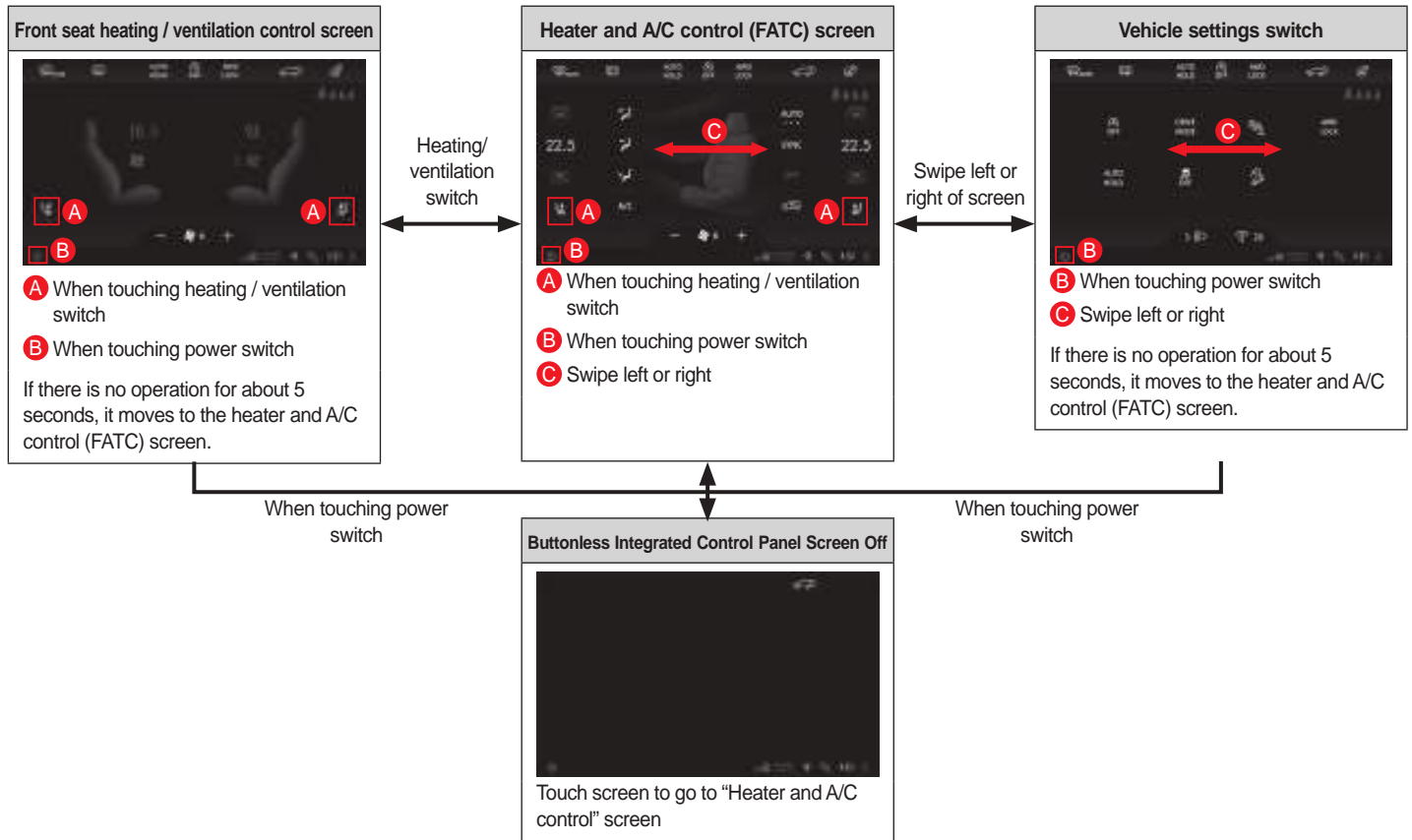

Buttonless Integrated Control Panel Screen Composition

Items to be displayed at all times



- 1 Defroster indicator (ADS)
- 2 Glass heater switch
- 3 Favorite menu switch
- 4 Tailgate switch
- 5 Steering wheel heating switch
- 6 Passenger and rear seat belt reminder indicator
- 7 Buttonless Integrated Control Panel Screen Off switch
- 8 Wireless charging indicator
- 9 Front PAS status indicator
- 10 Headlamp leveling status indicator
- 11 Door lock/unlock indicator

Heater and A/C control (FATC) screen



- 1 Defroster indicator (ADS)
- 2 Glass heater switch
- 3 Driver/Passenger Side Temperature Control Switch
- 4 Air distribution DEF / VENT / FOOT mode switch
- 5 AUTO switch
- 6 SYNC switch (to sync with driver side set temperature)
- 7 Heater and A/C ON/OFF switch
- 8 A/C ON/OFF switch
- 9 Air source selection switch
- 10 Fan Speed Control Switch

Front seat heating / ventilation control screen



- 1 Driver/passenger seat heating switch
- 2 Driver/passenger ventilation switch

Notice

- If there is no operation for about 5 seconds, it moves to the heater and A/C control (FATC) screen.

Buttonless Integrated Control Panel Screen Off

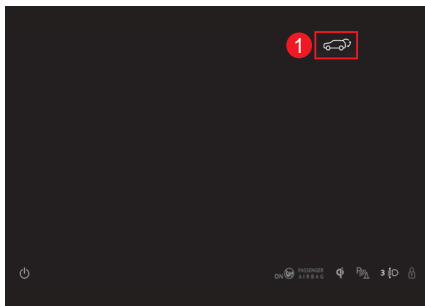

- 1 Tailgate switch

Vehicle settings switch



- 1 ISG OFF switch
- 2 Drive mode switch
- 3 Front obstacle detection ON/OFF switch
- 4 AWD LOCK switch
- 5 AUTO HOLD switch
- 6 ESC OFF switch
- 7 HDC switch
- 8 Headlamp leveling switch
- 9 Room lamp switch

Notice

- If there is no operation for about 5 seconds, it moves to the heater and A/C control (FATC) screen.

Buttonless Integrated Control Panel Favorites

How to set Favorites menu

For your convenience, you can register 3 favorite menus.



- 1 Touch and hold the Favorites menu to enter the setting screen.



- 2 Press and hold the switch you want to add to the Favorites menu, then drag and drop it to the Favorites list.
- 3 The menu is now visible in the Favorites list.

Buttonless Integrated Control Panel Reset

If the following occurs while using the buttonless integrated control panel, please initialize and reboot the system:

- Screen won't touch or switch
- Pop-up screen displayed and system not working

How To Reset

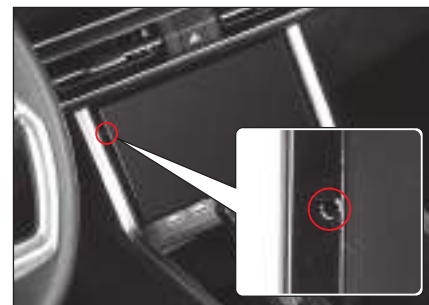

Turn the ignition switch to "IGN ON" position and press the RESET button on the upper right corner of the buttonless integrated control panel for about 1 second.

Notice

- The system reboot takes about 10 seconds or less.

Steering wheel

Adjusting the height/length of the steering wheel

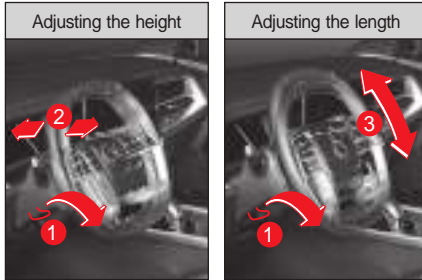

- 1 Push down the steering wheel telescoping/tilt control lever (1).
- 2 Adjust the position of the steering wheel upwards and downwards (2) and forwards and backwards (3) properly.
- 3 Lift the steering wheel telescoping/tilt control lever (1) up.

After adjusting the steering wheel, check that the steering wheel is secured firmly.

Warning

- Check that the steering wheel is secured firmly before driving.
- Do not adjust the steering wheel while driving. Doing so may cause a serious accident.

Caution

- Do not turn the steering wheel left or right to the end and maintain such position for 10 seconds or more with the engine started. Doing so may damage the power steering system due to overload.
- In winter (-10°C or below), starting off the vehicle immediately after starting the engine while the power steering fluid is cold can sometimes cause a momentary delay in the power steering, so be sure to let the engine idle properly before starting.

Steering wheel heater*

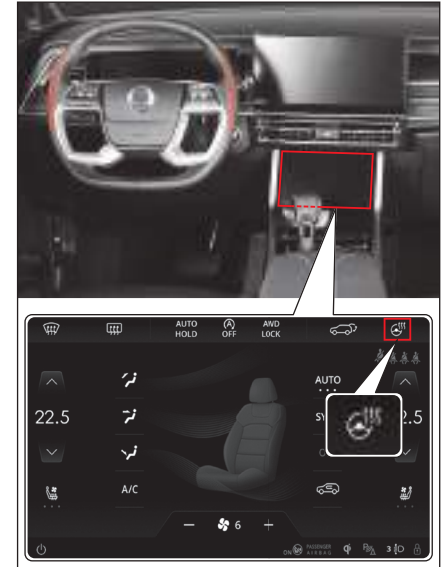

- To activate the steering wheel heater, touch the steering wheel heater switch while the engine is running. The operation indicator on the instrument cluster turns on.
- To deactivate the Steering wheel heater, touch the Steering wheel heater switch again. The operation indicator on the instrument cluster turns off.



Caution

- Do not attach an assist knob to the steering wheel. Doing so may damage the heater in the steering wheel and impede safe steering.

Notice

- The status of the Steering wheel heater switch is maintained even if the engine is turned off and on again.

Horn

Warning horn is sounded while the horn is being pressed.



Caution

- Using the horn may startle pedestrians. Use it carefully only when it is necessary.

Smart audio*



⚠ Caution

- The Android auto and Car Play in the vehicle may not be supported or some functions may not be compatible according to the specification or characteristics of the relevant device.
- The connection of the relevant devices to the vehicle may not be supported or some functions may not be compatible according to the specification or characteristics of the relevant video player, MP3 player.
- The method of use may be different or the connection to the vehicle may not be supported according to the specification or characteristics of the relevant Bluetooth device.

- Some USB storage devices and SD cards may not be compatible with the relevant device in the vehicle. Using a non-compatible memory card may damage the relevant device in the vehicle, memory card or data saved in the memory card.

Notice

- For detailed explanation regarding the infotainment system in the vehicle including smart audio and slots for multimedia, refer to the owner's manual provided separately.
- If you wish to connect an external device to the infotainment system in the vehicle including smart audio and slots for multimedia, refer to the owner's manual of the relevant device for how to connect and use such device.

⚠ Warning

- The rear camera screen does not work during software update. Always stop the vehicle to update the software and do not drive the vehicle until the update is completed.
- Be careful when reversing since the rear obstacle may be hidden by the warning messages and parking guide lines if the rear camera system is activated.

- The smart audio has an 9-inch touchscreen and four buttons, and can be operated with the buttons on the steering wheel.
- The USB port allows you to connect external devices to the multimedia socket.
- Including Bluetooth and rear view camera, the following apps are supported: Android Auto (for Android device) and CarPlay (for iOS device). (iOS devices can be charged through the USB port.)
- The operation information of the smart audio is displayed on the instrument cluster.

⚠ Caution

- During driving, video is not supported and only audio is supported for safety. When the vehicle stops, video is supported again.
- Do not use the audio system for a long period of time with the engine not started. Doing so may cause depletion of the battery in the vehicle.

AV/Navigation*

- You can operate the AV/Navigation on the 9-inch touch screen and the steering wheel buttons (voice recognition function is supported).
- An external device can be connected to the slots for multimedia using the USB port (iPod, iPhone and iPad are supported).
- Android auto (Android devices are supported) and Car Play (iPhone is supported) as well as Bluetooth, SD card (for navigation), rear camera and around view camera are supported.

The operation information of the AV/Navigation is displayed on the instrument cluster.

Warning

- **Be sure to use the navigation and video-related functions after stopping or parking the vehicle at a safe place for safe driving.**

Caution

- **Do not use the AV/navigation system for a long period of time with the engine not started. Doing so may cause depletion of the battery in the vehicle.**

Warning

- **The rear camera screen does not work during software update. Always stop the vehicle to update the software and do not drive the vehicle until the update is completed.**
- **Be careful when reversing since the rear obstacle may be hidden by the warning messages and parking guide lines if the rear camera system is activated.**

Slots for multimedia



With the USB port, you can connect the external music / video playback devices such as USB storage and iPod to the vehicle.

Caution

- **Some USB storage and external music / video playback devices may not be played through the USB port.**

Operating from the steering wheel



- 1 Bluetooth hands-free button
- 2 Mute button / Volume control lever
- 3 Media search (SEEK) lever
- 4 Mode selection button
- 5 Voice recognition button
- 6 LDWLKA SET button

Bluetooth hands-free

You can connect and use your mobile phone in the vehicle through Bluetooth.

Notice

- For detailed explanation regarding the Bluetooth hands-free, refer to the owner's manual provided separately.

MUTE Mute

- Tapping the Mute button with the audio system turned on turns off the voice output. Tapping it again turns on the voice output.
- Pressing and holding down the Mute button with the audio system turned on turns off the audio system.

Controlling the volume

Raises or lowers the volume.

Searching for media (SEEK)

Classification	Tap up/down the SEEK lever	Push up/down and hold the SEEK lever
When playing on the media screen	Plays the previous/next track	Moves to the previous/next list of tracks (The current playback is maintained)
When playing on a screen other than the media screen	Plays the next/previous track	Moves to the next/previous list of tracks (The current playback is maintained)
When listening in the radio screen	Moves to the previous/next saved channel	Moves to the next/previous available radio frequency
When listening in screens other than the radio screen	Moves to the next/previous saved channel	

MODE Selecting the mode

- The AV mode changes each time you press the Mode button.
- Tapping the Mode button with the AV system turned off, turns on the AV system.

Voice recognition function

This convenient function allows you to use various functions of the infotainment system through voice recognition.

Antenna

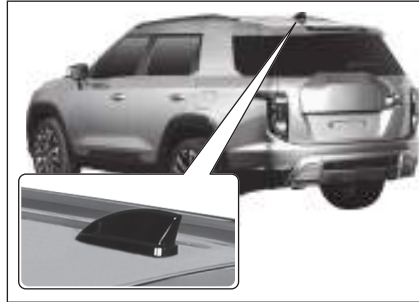

When the audio system is turned on, the antenna receives the following radio waves.

- Smart audio: GPS, radio, DAB (EU, GCC), GSM (e-call)
- AV/Navigation: GPS, radio, DAB, GSM

USB charging port

USB charging port (front side of front seat cup holder)



USB charging port (rear side of center console)



You can charge devices such as a smartphone or tablet PC using the USB charging port.

- In order to charge, connect the charging cable of the device to charge to the USB charging port (5V / 2.1A, 10.5W) in front side of the front seat cup holder with the engine started.
- With the engine turned on, connect the charging cable of a device you wish to charge to the USB charging port (5 V-2.1 A) at the rear side of the center console.
- For charging complete and charging progress, refer to the display screen of the device being charged.

Caution

- **Connect a device you wish to charge to the USB charging port after starting the engine and separate the device before turning off the engine. Failure to do so may damage the device being charged by sudden voltage variation when starting or turning off the engine.**
- **Caution should be taken that using the USB charging port with the engine turned off may cause depletion of the battery.**
- **Do not charge a device whose current consumption exceeds 2.1 A with the USB charging port. Doing so may disable charging, making the charging time longer or damage the USB charging port and the connected device.**
- **Caution should be taken that connecting the USB charging cable incorrectly may damage the fuses in the vehicle or the connected device due to a short circuit.**
- **Caution should be taken that if a foreign material or liquid such as water enters into the USB charging port, the charging port and the device may get damaged.**

Notice

- The charging speed of the USB charging port may vary depending on the type of and compatibility with the connected device, charging cable and other vehicle conditions.

Power socket

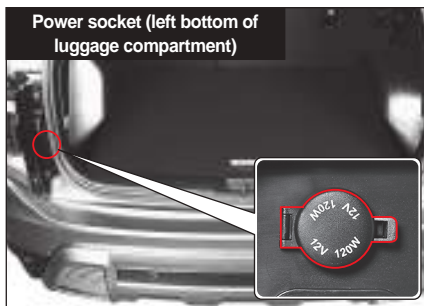
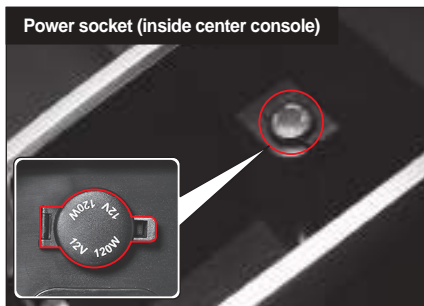

The power socket (12 V, 120 W) is provided in the vehicle to enable the use of a separate electrical device.

Warning

- Caution should be taken that inserting a finger into the power socket may cause injury such as an electric shock.
- Be sure to use a separate electrical device after connecting it to the power socket. Modifying the wires in the vehicle arbitrarily and using an electrical device may cause an accident such as a fire.
- Observe the rated capacity of the power socket (12 V, 120 W). Failure to do so may cause the power socket and the connected device to malfunction or fail.
- Caution should be taken that using the power socket with the engine turned off may cause depletion of the battery.
- If the power socket is not used, be sure to close the power socket cover. Failure to do so may let foreign material or liquid such as water enter into the power socket, causing damage to the device as well as an electric shock.

Sun visor and card holder (driver seat)

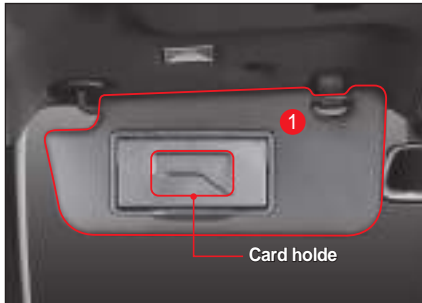

Sun visor

You can block out the sun from the front or the sides by lowering the sun visor (1).

- You can adjust the position of the sun visor (2) for blocking out the sun from the sides.

Card holder

The card holder is provided in the inside cover of the sun visor. It is convenient to store a motorway toll ticket or a card.

Caution

- **Adjusting the sun visor or using the card holder or mirror while driving may lead to careless driving or block the driver's vision, resulting in an accident.**
- **Adjust or use the sun visor and card holder after stopping or parking the vehicle.**

Mirror and lamp

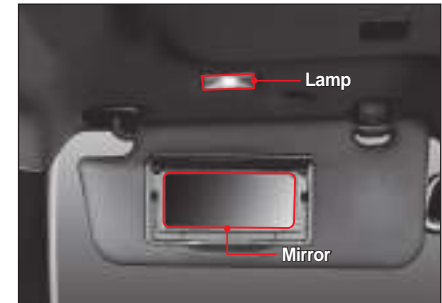

- You can use the mirror by lowering the sun visor and lifting up the cover.
- When you lift up the mirror cover, the lighting lamp turns on.

Caution

- **Be sure to close the mirror cover after using the sun visor mirror. Failure to do so may cause the sun visor lamp to stay on and the battery may be depleted. Also, an open mirror cover may cause injury.**

Grip handle/coat hanger



- The grip handle is installed on the side ceiling of the front passenger seat and rear seats (head lining).
- The coat hanger is included in the grip handle on the ceiling of the rear seats.

Warning

- Do not hang articles other than cloth on the coat hanger. Doing so may cause the side air bag to operate at the time of an impact of an accident, resulting in damage to the vehicle as well as the injury or death of an indoor occupant.

Caution

- Do not hang a heavy cloth on the coat hanger. Doing so may damage the coat hanger and the ceiling (head lining).

Rear seat door roller blind*

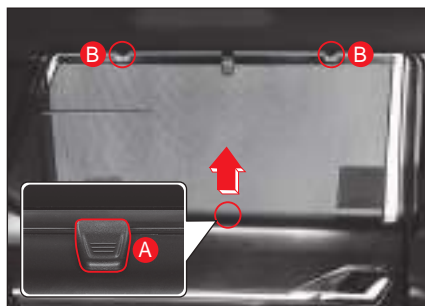

To block external light coming through the rear seat glass, operate the roller blind as follows:

- 1 Hold the roller blind ring (A) and lift it in the direction of the arrow.
- 2 Hang the roller blind on the hooks (B) mounted on both sides.

Caution

- Hanging the roller blind on only one hook may cause the roller blind to get deformed. Therefore, make sure to hang the roller blind on the both hooks.
- If any foreign material, such as coin, get inside the roller blind, it may cause a jam during its operation. Be careful not to do so.
- When lowering the roller blind, always grasp the handle in that status and slowly move it downward to rest it in place and then release the handle.
- Do not hang the objects other than the roller blind on the hooks.
- Pulling the roller blind forcibly or applying an excessive force to it may cause it to get crushed or deformed.
- Be careful when using the roller blind with the rear glass lowered as it may come off the hook.

Front seat/rear seat cup holder*

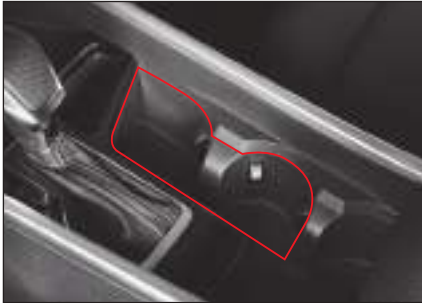

The cup holder is provided in front of the central console section.

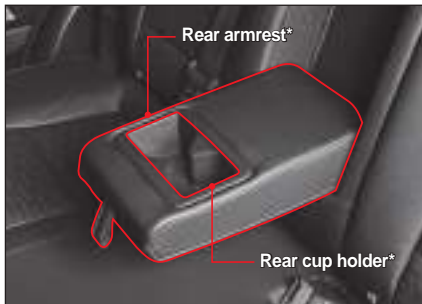

There is a cup holder when you lower the rear seat armrest.

Caution

- Caution should be taken that hot liquid in the cup may overflow or spill, causing a burn.
- Pay particular attention while driving since the cup may fall down or the liquid in the cup may spill over.
- Caution should be taken that if liquid in the cup spills over into the switches or operation buttons, it may cause trouble to the system functions.

Front storage (W/O WPC)

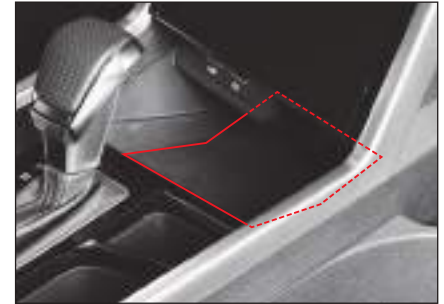

The front storage is provided near the gear shift lever. Use it for storing a small article.

Caution

- Caution should be taken that an article in the front storage may fall down or interrupt the operation of the gear shift lever.

Notice

- The front storage only applies to the vehicles without wireless charging system (WPC).

Front side storage box

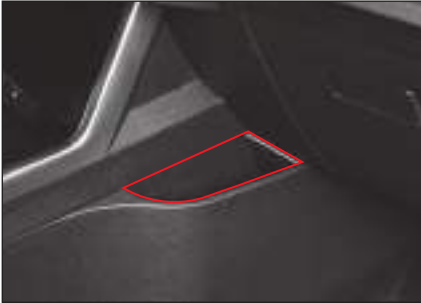

There is a storage box on the side of the center console (passenger side).

Rear storage box



There is a pocket type storage box at the back side of the center console. This is suitable for storing small items.

Glove box

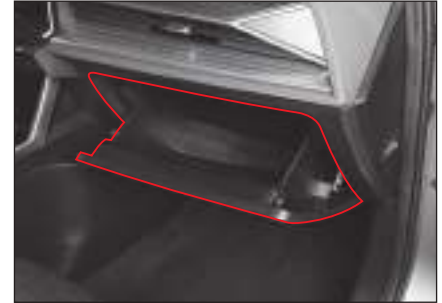

The glove box can be used for storing documents related to the vehicle registration or articles used in the vehicle conveniently.

- Pull on the glove box lever to open the glove box.



Caution

- Leaving the glove box opened may cause injury to an occupant in the event of an accident or sudden braking. Close the glove box while driving.
- Do not store any flammable materials or a cigarette lighter, etc. in the glove box, console or inside the vehicle. Doing so may cause an explosion during midsummer or the air inside the vehicle is heated.

Console



- The front seat console can conveniently store things for passengers in the front seats.



Caution

- Do not store any valuable article on the console for preventing theft.
- Do not store an article that can be damaged easily or creates noise on the console as it may move while driving.
- Do not store any flammable materials or a cigarette lighter, etc. in the console, the glove box, or indoor. Doing so may cause an explosion during midsummer or when the air inside the vehicle is heated.

Door map pocket

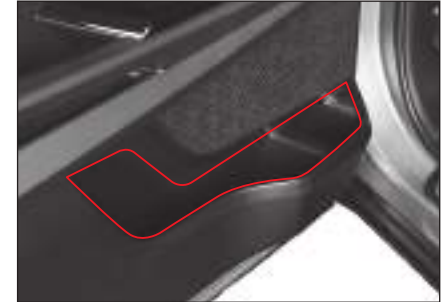

The pocket (bottle tray) where books, magazines, water bottles or beverages can be stored is provided.

Seat backrest pocket



It can be used conveniently for storing magazines or newspapers.



Caution

- Do not store scissors, knives, or other objects with an improper size in the seat backrest pocket. Doing so may cause personal injury in the event of sudden braking or a vehicle collision.

Wireless Phone Charger System*

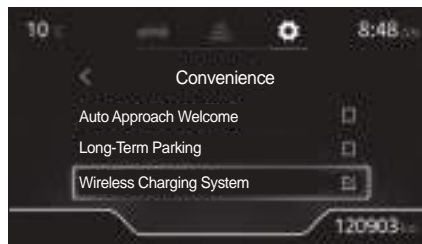

The wireless phone charger system is a device that wirelessly charges the electronic devices (such as mobile phone) that conforms to Qi standard, which is located in front of the transmission selector lever.

The wireless phone charging is available only when the driver sets (ticks) the wireless charging system under User Settings menu in the instrument cluster.

To Charge Phone

- 1 Close all the vehicle doors and start the vehicle.
- 2 Set (Tick) the wireless charging system under User Settings (User setting → Convenience → Wireless charging system) menu in the instrument cluster.
- 3 Remove everything including the smart key on the wireless charging pad. If there is anything other than the phone on the charging pad, it may not charge.
- 4 Place the wireless charging enabled phone in the center of the charging pad.
- 5 When charging begins, the mobile phone's charging status is indicated by the color of the wireless charging symbol displayed on the lower right side of the 8-inch buttonless integrated control panel:
 - Gray: Wireless charging off
 - Green: Phone charging completed
 - Yellow (solid): Charging in progress
 - Yellow (blink): Charging fault



⚠ Caution

- If any phone is on the wireless charging pad after the ignition is off while the wireless phone charger is operating, a reminder message “The phone is on the wireless phone charger.” is displayed on the instrument cluster. After turning off the ignition, be sure to leave the vehicle with your phone.
- The reminder function is turned on when the ignition switch is changed from the ON position to the ACC or OFF position. However, it does not work when changing the ignition switch from the OFF position to ACC position.

Notice

- The wireless phone charger system can be used to charge the mobile phones only that conform to the Qi standard. Whether your phone meets the Qi standard can be checked with a separate accessory cover or phone manufacturer.
- The charging function can be turned on (tick) or off (untick) under the User Settings menu in the instrument cluster.

⚠ Caution

- If the temperature or voltage inside the wireless phone charger system exceeds a certain value, the charging function is temporarily stopped to protect the phone and the system.
- The farther your phone is from the center of the charging pad, the less charging efficiency the phone may have.
- Be sure to position your phone in the center of the wireless charging pad.
- Depending on the type of mobile phone cover, charging may not work or a lot of heat may be generated. (e.g., LED cover, thick cover)
- Charging may stop if the mobile phone is not securely pressed against the wireless charging pad.
- If there are magnetic products (credit card, check card, bankbook, ticket and etc.) around the wireless phone charger, its information may be damaged.
- If a metal object is on the wireless charging pad, charging does not work or may stop and a metal object may become hot during charging.
- The mobile phone which is not Qi standard certified may not be charged.



Caution

- Charging stops temporarily when the smart key detection function is activated. (e.g., when starting the vehicle, immediately after the door is open / closed)
- If the terminal that complies with the Qi standard does not provide a full charge information, charging may continue to generate heat.
- If more than one terminal is placed, charging does not work.
- On some manufacturers' phones, the relevant information may not appear on the instrument cluster.
- For the mobile phones that do not have a built-in wireless charging feature, you have to equip with separate accessories individually.
- If you place a phone or metallic object that does not have wireless charging on the charging pad, you may hear some noise. (The noise is a normal operation sound generated in the process of determining whether the mobile phone can be charged wirelessly, which does not affect the mobile phone and the vehicle.)

Additional equipment in the luggage compartment*

Luggage upper cover

The luggage upper cover is used for covering luggage so that it cannot be seen.

Installing the luggage upper cover

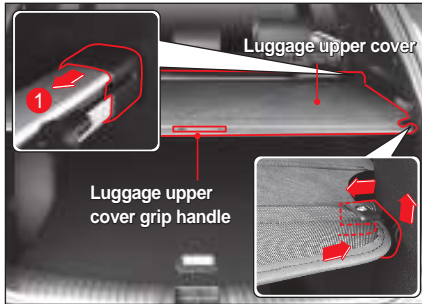

- 1 Fit both ends of the luggage upper cover into the groove on the vehicle body by pressing them in the arrow direction (1).
- 2 Pull the luggage upper cover grip handle and fit it into the groove on the vehicle body.

Caution

- Do not place any article on top of the luggage upper cover. Doing so may cause the article to bounce forward, injuring an occupant or damaging the luggage upper cover.
- Do not press the top of the luggage upper cover forcibly. Doing so may damage the luggage upper cover.
- Do not relocate the luggage upper cover when it is pulled out. Doing so may damage the luggage upper cover.

How to store luggage upper cover



- 1 Lift out the luggage compartment board in the direction of the arrow.



- 2 Pull the left / right end (1) of the luggage compartment upper cover inward and fix it in the groove. The other side is also performed in the same way.



- 3 Make sure that the luggage upper cover is secured firmly.

Luggage compartment

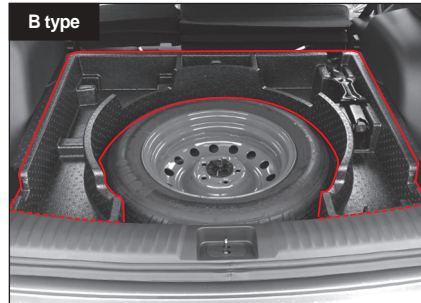
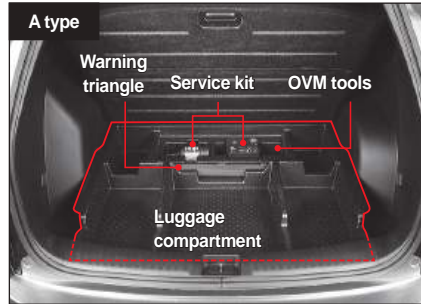

Below the luggage compartment board is a luggage compartment storage box for storing a warning triangle and OVM tools, including a service kit.

Roof rack*

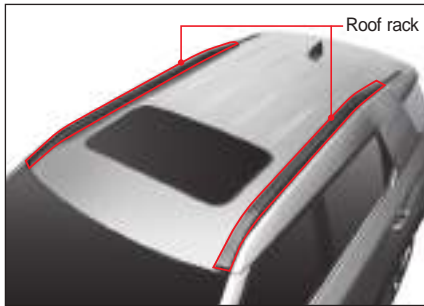

The luggage can be loaded onto the top of the vehicle roof using the roof rack.

Also, leisure sporting goods such as a bicycle, snowboard and skis by installing a separate carrier on the roof rack.

- The maximum loading capacity of the roof rack is 100 kg (220 lbs).

Warning

- The luggage loaded onto the roof rack should not exceed the maximum loading capacity. The luggage loaded onto the roof rack should not stick out of the roof. If the maximum loading capacity is exceeded or the luggage sticks out of the roof rack, the relevant vehicle or other vehicles may be damaged. In addition, it adversely affects the driving stability of the vehicle and may cause an accident while driving.
- Fix the luggage to the roof rack safely, and in case of driving for a long period of time, check the fixing status of the luggage frequently. If the luggage loaded onto the roof rack falls off from the vehicle, other vehicles may be damaged or a pedestrian may get injured. Also, it may cause a bigger accident.
- When luggage is loaded onto the roof rack, the center of gravity of the vehicle becomes higher. If you control the steering wheel suddenly while applying sudden braking, making sharp turn or driving at a high speed, the vehicle may become unstable, causing an accident or overturning of the vehicle.
- If the luggage is loaded onto the roof rack, check the tightening status of roof rack fixing bolts and nuts frequently.
- Drive the vehicle at a low speed if possible when luggage is loaded onto the roof rack.

Caution

- Caution should be taken that if you load luggage onto the roof rack of a vehicle where a sunroof is installed, the luggage should not interrupt the operation of the sunroof.

Notice

- A protective gear such as a cushion or a cloth can be inserted between the luggage and the roof rack in order to prevent the vehicle from being damaged by contact between the luggage loaded onto the roof rack and the vehicle roof.

<https://www.automotive-manuals.net/>

4. Starting and driving

You can check information regarding the basic equipment for safe driving, auxiliary equipment that helps you to drive comfortably, and how to use such equipment.

An explanation is provided for the START/STOP switch and smart key as well as the driving system including the instrument cluster, gear shift lever, 4WD, cruise control, auxiliary driving systems such as the brake and autonomous emergency braking system, rear and side warning, lane departure warning system, and parking assist system.

START/STOP switch (Smart key)*

OFF status

The power is turned off.



The indicator is turned off.

- The power is not supplied to the electric accessories of the vehicle.

Caution

- If the gear shift lever is not placed in the P (parking) position, the START/STOP switch cannot be in the OFF status (vehicle power OFF). Also, the vehicle doors cannot be locked and it is impossible to enter the theft monitoring mode.

Notice

- When the engine is turned on, make sure to place the gear shift lever in the P (parking) position and turn off the engine by pressing the START/STOP switch.

ACC status

Some electric accessories can be used.



Orange ACC indicator turns on.

- With the START/STOP switch in the OFF status, press the START/STOP switch once without depressing the brake pedal.
- The power is supplied to the vehicle and some electric accessories can be used.

Caution

- The START/STOP switch in the ACC status is not the status that the engine is turned on. Using an electric accessory in the vehicle for a long period of time in this status may deplete the battery.

ON status

Most electric accessories can be used.



Red ON indicator turns on.

- With the START/STOP switch in the OFF status, press the START/STOP switch twice without depressing the brake pedal.
- The power is supplied to the vehicle and most electric accessories can be used.

Caution

- The START/STOP switch in the ON status is not the status that the engine is turned on. Using an electric accessory in the vehicle for a long period of time in this status may deplete the battery.
- If the smart key system is abnormal, the indicator blinks 5 times with the START/STOP switch in the ON status. Have your vehicle checked and serviced at a KG Mobility Authorized Service Center immediately.

READY status

Possible to start the engine



Green READY indicator turns on.

- This is the status that the gear shift lever is placed in the P (parking) or the N (neutral) position and the brake pedal is depressed for starting the engine.

Warning

- The engine can also be started after the gear shift lever is placed in the N (neutral) position. However, start the engine after placing it in the P (parking) position for safety.

Notice

- After you start the engine, the READY indicator turns off.

Starting the engine

When you place the gear shift lever in the P (parking) or the N (neutral) position and press the START/STOP switch while depressing the brake pedal, the engine is started.

Starting the engine

- 1 Get in the vehicle while carrying the smart key.
- 2 Be sure that all occupants fasten their seat belt.
- 3 Check for safety that the parking brake is applied.
- 4 Turn off all electric accessories.
- 5 Place the gear shift lever in the P (parking) or N (neutral) position.
 - **Manual transmission**
Place the gear shift lever in the N (neutral) position and depress the pedal.
- 6 Depress brake pedal.
- 7 Check if the READY status indicator on START/STOP switch is turned on.
- 8 If the READY status indicator is turned on, start the engine by pressing the START/STOP switch.

When the engine is started, the READY indicator turns off.



Warning

- **The engine can also be started also after the gear shift lever is placed in the N (neutral) position. However, start the engine after placing it in the P (parking) position for safety.**

Restarting the engine when it cannot be started

Wait for more than 10 seconds with the START/STOP switch in the OFF status and then press the START/STOP switch again to prevent the starting motor from being damaged.



Caution

- **Do not press and hold down the START/STOP switch or press it repeatedly because the engine cannot be started.**
- **The communication with the smart key system is not smooth on top of the seat where the heater function is activated or the floor of the vehicle and the area near the pedal, so the smart key recognition performance may be lowered.**
- **If the engine cannot be started by pressing the START/STOP switch, press the START/STOP switch directly using the smart key or have your vehicle checked and serviced at a KG Mobility Authorized Service Center.**
 - ☞ Refer to “Starting the engine with the dead smart key or interference, etc. (in the event of emergency)” (p.4-19)
- **Maintaining the START/STOP switch ACC or ON status and using the audio system with the engine turned off may deplete the battery.**

Stopping the engine

The engine can be turned off only when the gear shift lever is placed in the P (parking) position and the brake pedal is depressed.

- 1 After stopping the vehicle completely, keep the brake pedal depressed.
- 2 Shift the gear shift lever to the P (Parking - A/T) or N (neutral - M/T) position.
- 3 Apply the parking brake.
- 4 Turn off the engine by pressing the START/STOP switch, and then take your foot off the brake pedal (A/T) or clutch pedal (M/T).

Be sure to check that the engine is turned off and if there are any other abnormalities, and get out of the vehicle with the smart key.

Stopping the engine while driving (in the event of emergency)

If you need to turn off the engine in an emergency situation such as an accident or vehicle damage while driving, press and hold down the START/STOP switch for 3 seconds or more, or press it three times within 1.5 seconds.

The engine is turned off and the START/STOP switch is set to the ACC status.



Warning

- **Never turn off the engine while driving unless there is an emergency situation such as an accident or vehicle damage. Doing so may make the steering wheel heavier and lower the brake performance, becoming very dangerous.**

Notice

- **If the vehicle is driving continuously with the engine turned off, you can start the engine again by placing the gear shift lever in the N (neutral) position and pressing START/STOP switch without depressing the brake pedal.**

System safety mode

If a critical system defect occurs or the main electric and fuel systems of the engine are abnormal, the system enters the safety mode in order to protect the vehicle system.

When the vehicle enters the system safety mode, the engine warning light may turn on and the driving performance may decrease or the engine may be turned off.



Caution

- **When the vehicle enters the system safety mode, stop the vehicle at a safe place immediately, turn off the engine, tow your vehicle to a KG Mobility Authorized Service Center through the emergency roadside service and have the relevant system checked and serviced.**
- **If you drive the vehicle in the system safety mode, the engine RPM is fixed, disabling normal driving and the engine may be turned off. Driving the vehicle continuously may damage the system significantly.**

Cautions for using the START/STOP switch



Warning

- The smart key system allows you to start the engine by pressing the START/STOP switch with the brake pedal depressed within its operation range. Caution should be taken that a person who is unfamiliar with the system such as the engine check and in any other situations, especially a child, may start the engine.
- Never press the START/STOP switch while driving. Doing so may result in a dangerous situation due to the suspension of power supply.



Caution

- Be sure to start the engine with the brake pedal depressed.
- Do not depress the accelerator pedal when starting the engine.
- If the engine cannot be started, wait for 10 seconds or more to prevent the starting motor from being damaged and restart the engine.
- After starting the engine, idle the engine for 1 to 2 minutes and then drive off in the vehicle. In particular, drive the vehicle slowly for approximately 300 m after driving off for smooth rotation of the engine and other driving systems during winter.
- If you open the door and leave the vehicle with the smart key with the START/STOP switch in the ON status or while the engine is running, a warning message is displayed on the instrument cluster with a warning buzzer.
- Pay particular attention not to start the engine when checking the vehicle from the outside, especially the engine room.
- Do not use a non genuine smart key or a replicated key.

- The communication with the smart key system is not smooth on top of the seat where the heater function is activated or the floor of the vehicle and the area near the pedal, so the smart key recognition performance may be lowered.
- The vehicle is controlled by various electronic control units. If you attach and use a device that creates radio waves or electromagnetic waves near the smart key or the vehicle, various vehicle control systems may malfunction.
- When you operate the START/STOP switch while a smartphone is placed near the smart key or charging the smartphone battery through the power socket in the vehicle, the engine may not start occasionally.

Key cylinder (ignition key)

OFF position (LOCK)

The power is turned off.

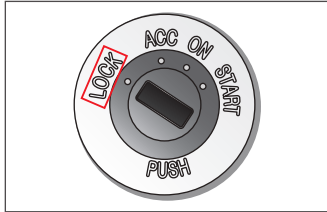

- The power is not supplied to the electric accessories of the vehicle.

Notice

Key hole illumination

- When you open the door to get into the vehicle, the light is lit around the key cylinder. If you close the door, the lights will turn off after about 10 seconds.

ACC position

Some electric accessories can be used.

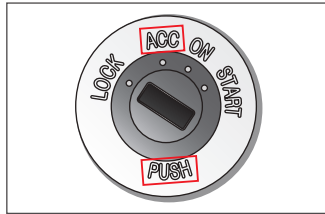

- The power is supplied to the vehicle and some electric accessories can be used.
- To shift from the ACC position to the OFF (LOCK) position, turn the ignition key while pressing the key cylinder with the ignition key.

Notice

Key reminder

- When you open the driver's door with the ignition key inserted in the key cylinder (ACC or LOCK position), a warning beep sounds to inform the driver that the ignition key is inserted in the key cylinder.

ON position

Most electric accessories can be used.

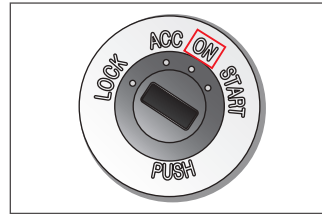

- The power is supplied to the vehicle and most electric accessories can be used.
- It is the position where the ignition key is located when operating the vehicle, with the engine started.

START position

Starting engine

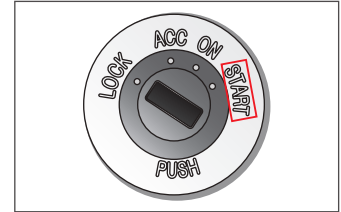

- This is the status that the gear shift lever is placed in the P (parking) or the N (neutral) position and the brake pedal is depressed for starting the engine.
- It is the position to start the engine. Turning the key cylinder to the "START" position will start the engine. Release the ignition key when the engine is started. At this time, the key cylinder returns to the ON position automatically.

Warning

- The engine can also be started after the gear shift lever is placed in the N (neutral) position. However, start the engine after placing it in the P (parking) position for safety.

Starting the engine

In order to start the engine, place the gear shift lever in the P (park) or N (neutral) position, insert the ignition key into the key cylinder and turn it to the START position while depressing the brake pedal.

Starting the engine

- 1 Get on the vehicle with carrying the REKES key (ignition key).
- 2 Be sure that all occupants fasten their seat belt.
- 3 Check for safety that the parking brake is applied.
- 4 Turn off all electric accessories.
- 5 Place the gear shift lever in the P (parking) or N (neutral) position.
 - **Manual transmission**
Place the gear shift lever in the N (neutral) position and depress the pedal.
- 6 Depress brake pedal.
- 7 Insert the ignition key into the key cylinder.
- 8 Turn the key cylinder to the START position to start the engine.



Warning

- **The engine can also be started also after the gear shift lever is placed in the N (neutral) position. However, start the engine after placing it in the P (parking) position for safety.**

Restarting the engine when it cannot be started

To prevent damage to the starter motor, wait at least 10 seconds while the ignition key is in the OFF position and turn the key cylinder to the "START" position again.



Caution

- **Do not leave the key cylinder in the START position for more than 10 seconds even if the engine does not start.**
- **Do not turn the key cylinder to the START position once the engine is started. This can damage the relevant components including the starter motor.**
- **If you leave the key cylinder in the ACC or ON position or use the audio system and etc. for an extended period of time with the engine not started, the battery may be discharged.**

Stopping the engine

The engine can be turned off only when the gear shift lever is placed in the P (parking) position and the brake pedal is depressed.

- 1 After stopping the vehicle completely, keep the brake pedal depressed.
- 2 Shift the gear shift lever to the P (Parking - A/T) position.
- 3 Apply the parking brake.
- 4 Turn off the engine by pressing the START/ STOP switch, and then take your foot off the brake pedal (A/T) or clutch pedal (M/T).

Be sure to check that the engine is turned off and if there are any other abnormalities, and get out of the vehicle with the smart key.

Notice

- Diesel engine learning mode and engine self-cleaning operate in the same way as smart key engine start and engine stop.

System safety mode

If a critical system defect occurs or the main electric and fuel systems of the engine are abnormal, the system enters the safety mode in order to protect the vehicle system.

When the vehicle enters the system safety mode, the engine warning light may turn on and the driving performance may decrease or the engine may be turned off.



Caution

- When the vehicle enters the system safety mode, stop the vehicle at a safe place immediately, turn off the engine, tow your vehicle to a KG Mobility Authorized Service Center through the emergency roadside service and have the relevant system checked and serviced.
- If you drive the vehicle in the system safety mode, the engine RPM is fixed, disabling normal driving and the engine may be turned off. Driving the vehicle continuously may damage the system significantly.



Warning

- Never turn the key cylinder (ignition key) to the OFF (LOCK) position or remove the ignition key while driving. If you operate the key cylinder (ignition key) while driving, the power may be cut off and a dangerous situation may occur.



Caution

- Be sure to start the engine with the brake pedal depressed.
- Do not depress the accelerator pedal when starting the engine.
- If the engine cannot be started, wait for 10 seconds or more to prevent the starting motor from being damaged and restart the engine.
- After starting the engine, idle the engine for 1 to 2 minutes and then drive off in the vehicle. In particular, drive the vehicle slowly for approximately 300 m after driving off for smooth rotation of the engine and other driving systems during winter.
- If you try to open the door and get off the car with the ignition key inserted in the key cylinder, a warning message will be displayed on the instrument cluster and a warning beep will sound.
- Pay particular attention not to start the engine when checking the vehicle from the outside, especially the engine room.
- Do not use non-genuine REKES key or replication key.

Smart key* & REKES key

Function of each button

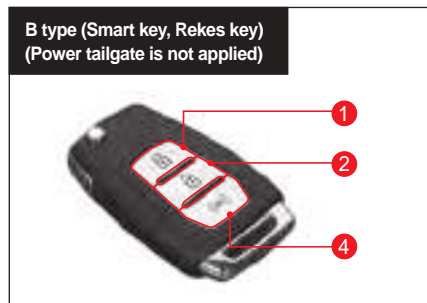
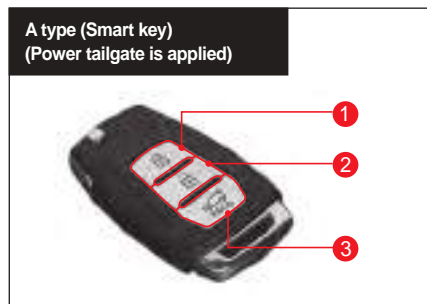

Button	Press briefly	Press and hold down
① Door lock	Lock the door	
② Door unlock	Unlock the door (When the safety unlock is set, only the driver seat door is unlocked)	
③ Tailgate (A type)	Stop the operation	Open/close the power tailgate
④ Panic (B type)	-	Activate/deactivate the panic mode

Locking the door

Pressing the Door lock button (①) briefly locks all doors and the tailgate.

- When switched to the theft deterrent mode, the hazard warning lamp blinks and a buzzer sounds.

	Hazard warning lamp	Buzzer
Smart key (type A/B)	Blinks twice	Sounds once
REKES key (type B)	Blinks twice	-

- If the outside Rearview mirror folding/unfolding button is in the neutral position, the outside rearview mirror is folded.
☞ Refer to "Folding/unfolding the outside rearview mirror" (p.3-56)

Notice

- If the START/STOP switch is in the ACC or the ON status or the engine is running, the door cannot be locked using the Door lock button.

! Caution

- The mode can be switched to the theft monitoring mode only when all doors, tailgate and engine hood are closed. When you press the Door lock button with the tailgate or the engine hood open, only the door is locked and the mode is not switched to the theft monitoring mode.
- After locking the door using the smart key or rekes key, check that the door and the tailgate are locked directly. If the door is not locked completely, the vehicle or an article inside the vehicle may be stolen.

Unlocking the door (when the safety unlock is enabled)

- When the safety unlock is enabled, pressing the Door unlock button (2) only unlocks the driver seat door and cancels the theft monitoring mode.



- Pressing the Door unlock button (2) again with the driver seat door unlocked unlocks all doors and the tailgate.



- Pressing the Door unlock button (2) twice in a row unlocks the driver seat door first, then unlocks all doors and cancels the theft monitoring mode.
- When the theft deterrent mode is deactivated, the hazard warning lamp blinks and a buzzer sounds.

	Hazard warning lamp	Buzzer
Smart key (type A/B)	Blinks once	Sounds twice
REKES key (type B)	Blinks once	-

- When the rear view mirror folding / unfolding button is in the neutral position, the rear view mirrors unfold.

☞ Refer to "Folding/unfolding the outside rearview mirror" (p.3-56)

What is safety unlock?

The safety unlock function unlocks only the driver seat door when the Door unlock button is pressed once to prevent entering through a door other than the driver seat door. Pressing the Door unlock button again unlocks all doors and the tailgate.

To set safety unlock

- Tick the box at **User setting** → **Door / Tailgate** → **Press key twice to unlock** under  (user settings) in the instrument cluster.

- In theft deterrent mode, if a door, tailgate or engine hood is not opened within 30 seconds after the door is unlocked, all the doors are locked automatically.
- In this case, the system is switched to the theft deterrent mode, the hazard warning lamp blinks and a buzzer sounds.

	Hazard warning lamp	Buzzer
Smart key (type A/B)	Blinks twice	Sounds once
REKES key (type B)	Blinks twice	Sounds once

Notice

- In the event of auto lock after 30 seconds, the rear view mirror will not fold even if the rear view mirror folding / unfolding button is in the neutral position.

Unlocking the door (when the safety unlock is disabled)

Pressing the Door unlock button (2), briefly unlocks all doors and the tailgate.



- When the theft deterrent mode is deactivated, the hazard warning lamp blinks and a buzzer sounds.

	Hazard warning lamp	Buzzer
Smart key (type A/B)	Blinks once	Sounds twice
REKES key (type B)	Blinks once	-

- If the outside Rearview mirror folding/unfolding button is in the neutral position, the outside rearview mirror is folded.

☞ Refer to "Folding/unfolding the outside rearview mirror" (p.3-56)

Opening/closing the tailgate (A type)

- You can open or close the tailgate by pressing and holding down the Tailgate button (3).
- Pressing the Tailgate button (3) briefly stops the operation of the power tailgate.
- When you approach within approximately 1 m from the center of the tailgate with the smart key, the smart tailgate operates.

☞ Refer to "Tailgate" (p.3-25)

Activating/deactivating the panic mode (B type)

When you press the Panic button in the event of emergency, the hazard warning lamp turns on and the warning buzzer sounds for a certain period of time.

- When you press and hold down the Panic button (4), the hazard warning lamp blinks and the warning buzzer sounds for approximately 30 seconds.
- Pressing and holding down the Panic button (4) again stops the panic mode.

Additional functions

Smart door auto lock (auto close)

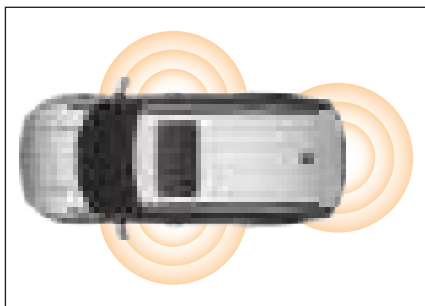

When you move a certain distance away from the vehicle while carrying the smart key, all doors and the tailgate are locked automatically.

If you stay in the smart key detection area of the vehicle for 10 minute or more under the above condition, all doors and the tailgate are also locked automatically for theft prevention.

- When the theft monitoring mode is activated, the hazard warning lamp blinks twice and the warning buzzer sounds once.
- If the Outside rearview mirror folding/unfolding button is in the neutral position, the outside rearview mirror is folded.

☞ Refer to "Folding/unfolding the outside rearview mirror" (p.3-56)

Activating the smart door auto lock function (Activating from the instrument cluster)

- Tick the box at **User setting** → **Door / Tailgate** → **Smart door auto lock** under (user settings) in the instrument cluster. 

Activating the smart door auto lock function (Activating with the smart key)

- 1 With the START/STOP switch in the ON status, press the hazard warning lamp switch.
The hazard warning lamp turns on.
- 2 Press the Door lock button on the smart key three times consecutively within 2 seconds.

Notice

- The smart door auto lock is carried out only if the smart key is detected near the vehicle (in the outside antenna area) when you close the door.
- The detection of the smart key varies depending on the walking speed and surrounding environment.
- If the smart key is present inside the vehicle, the smart door auto lock function is not activated.
- If the smart key battery is depleted, the smart door auto lock function is canceled automatically. Replace the smart key battery and activate it again from  (User Settings) on the instrument cluster.



Caution

- When you lock the door using the smart door auto lock function, check that the hazard warning lamp blinks twice and the warning buzzer sounds once. If the door is not locked completely, the vehicle or an article inside the vehicle may be stolen.

Locking/unlocking the door with the door handle switch

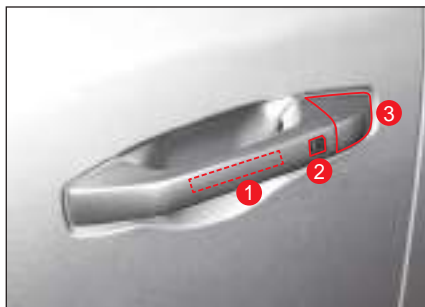
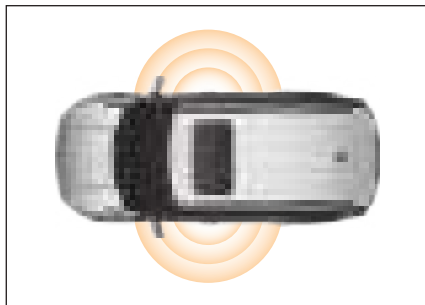

- 1 Outside antenna
- 2 Door lock/unlock button
- 3 Mechanical key hole

To lock with door handle switch

- 1 Stay in the outside antenna area of the vehicle (approximately 1 m) while carrying the smart key.
- 2 Press the door lock / unlock button (2) with all the doors and tailgate closed.
- 3 All the doors and tailgate are closed.
 - When the theft monitoring mode is activated, the hazard warning lamp blinks twice and the warning buzzer sounds once.
 - If the Outside rearview mirror folding/unfolding button is in the neutral position, the outside rearview mirror is folded.

☞ Refer to "Folding/unfolding the outside rearview mirror" (p.3-56)

Notice

- It is not possible to lock the door with the door lock / unlock button when the ignition switch is in ACC or ON position or the engine is started.

To unlock with door handle switch (when the safety unlock is disabled)

- 1 Stay in the outside antenna area of the vehicle (approximately 1 m) while carrying the smart key.
- 2 Press the door lock / unlock button (2).
 - Once the smart key authentication is completed, all the doors and tailgate are unlocked.
 - When the theft monitoring mode is activated, the hazard warning lamp blinks twice and the warning buzzer sounds once.
 - If the Outside rearview mirror folding/unfolding button is in the neutral position, the outside rearview mirror is folded.

☞ Refer to "Folding/unfolding the outside rearview mirror" (p.3-56)



- 3 Open the driver seat door by pulling the door handle slowly.

To unlock with door handle switch (when the safety unlock is enabled)

- 1 Stay around the driver's door outside antenna area (within approx. 1m) with a smart key.
- 2 Press the door lock / unlock button (2).
 - Once the smart key authentication is completed, only the driver's door is unlocked.
 - The hazard warning lamp flashes once and buzzer sounds twice indicating that the theft deterrent mode is deactivated.
- 3 Open the door by pulling the door handle slowly.
 - Press the door lock / unlock button (2) one more time within 4 seconds with the driver's door unlocked if you want to unlock all the doors and tailgate.
 - All the doors and tailgate are unlocked.
 - The hazard warning lamp flashes once and buzzer sounds twice when all the doors are unlocked.

Notice
<ul style="list-style-type: none">• When you press the passenger's door handle lock / unlock button with the safety unlock set, all the doors are unlocked.• When you press the driver door lock / unlock button 4 seconds after the driver door is unlocked, all doors will be locked and the system enters the theft deterrent mode.• Tick the box at User setting → Door / Tailgate → Press key twice to unlock under  (user settings) in the instrument cluster.

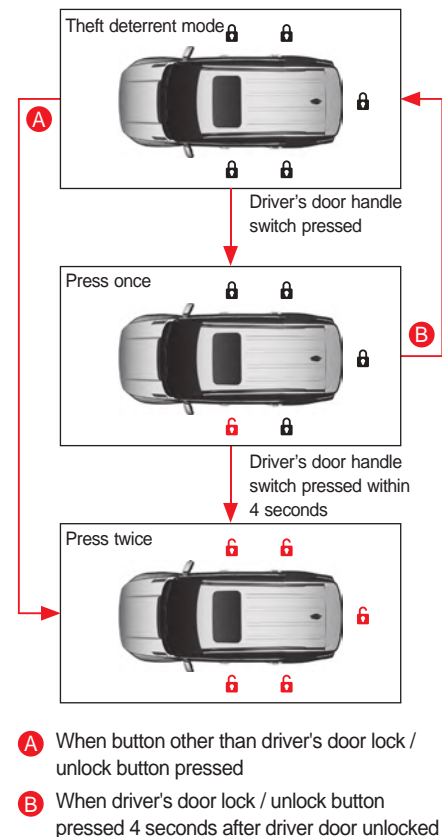

Cautions for using smart key / REKES key



Warning

- Do not leave the vehicle with the smart key in the vehicle when a person (especially a child) who does not know the vehicle system is present in the vehicle. Pressing the START/STOP switch with the brake pedal depressed while the smart key is in the vehicle starts the engine. Other incorrect vehicle controls may occur. In such case, a serious accident may occur. Therefore, always pay attention.



Caution

If the smart key does not operate or is not recognized

- When you lock the door with the door handle lock / unlock button or another smart key outside the vehicle with the smart key inside the vehicle, the smart key in the vehicle will be disabled temporarily (buzzer sounds).

To restore to the original function, deactivate the theft deterrent mode by using the smart key outside the vehicle or door handle lock / unlock button.

- If the vehicle is in a place where strong radio waves are transmitted or received, if the vehicle is equipped with a two-way radio or other transmission and reception systems or if a smart key is used in another nearby vehicle, the smart key system may not function normally.
- The smart key recognition performance may be lowered on a blind spot above the seats where the heater function is activated or the floor of the vehicle and the area near the pedal, so the smart key system may not function. In such case, carry the smart key or place the smart key in a different location.
- If the engine cannot be started while the smart key is placed inside the vehicle or you are carrying it, start the engine by pressing the START/STOP switch with the smart key directly.
- If the smart key is near the outside windshield or the door glass, the smart key may be recognized as being present inside the vehicle. In this case, the smart key system may not operate normally.

Using the smart key

- Carry only one smart key.
- Store each smart key separately. When you lock the door using the LOCK touch sensor on the door handle instead of the Door lock/unlock button on the smart key, be careful not to leave the smart key inside the vehicle.
- If you leave the vehicle even for a moment, turn off the engine and carry the smart key with you and do not store a spare smart key inside the vehicle. Failure to do so may cause vehicle theft or malfunction.
- Using 2 smart keys provided by KG Mobility Corporation on one key chain at the same time may cause the smart key system to malfunction or engine starting failure.

Managing the smart key

- When you lock the door with another smart key with the previously used smart key in the vehicle, the door can be locked normally but you cannot start the engine with the key left in the vehicle until it is used normally next time. This is a safety system for preventing theft.

- Do not allow water or liquid to flow into the smart key. Caution should be taken as the smart key is not fully waterproof, so if moisture or water gets in, it may cause a malfunction that is not covered by the warranty.
- The electronic systems in the smart key are vulnerable to moisture or heat, so placing the smart key in a place with high humidity or high temperature may cause a failure.
- If the smart key is lost, you cannot open the door or start the engine. If you don't have a spare smart key in storage, you need to have your vehicle towed and serviced at a KG Mobility Authorized Service Center. Also, the vehicle or an article in the vehicle may be lost due to the lost smart key, so take measures immediately.

Cautions for using door handle lock / unlock button

- Anyone within the operating range of the smart key can unlock the door with the door handle lock / unlock button. Be careful of theft.
- Do not operate locking or unlocking as soon as you lock / unlock the door.

Using the emergency key

Unfolding/folding the emergency key

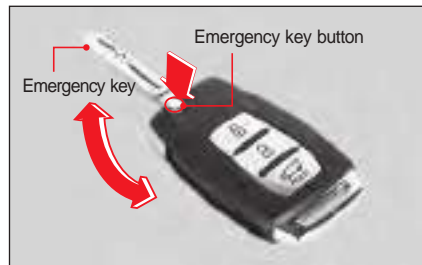

- Pull out the emergency key from the key body by pressing the Emergency key button on the smart key/rekes key.
- To fold the emergency key, fold the emergency key with the Emergency key button pressed.



Caution

- **Folding the emergency key forcibly without pressing the Emergency key button may damage the smart key.**

Locking/unlocking the door using the emergency key

If the door cannot be locked or unlocked due to reasons including the depletion of the smart key battery, interference, and the depletion of the vehicle battery, the emergency key (auxiliary key) can be used.

- 1 Pull the driver seat door handle in the arrow direction in a way that the Emergency key hole cover open button (1) is visible.

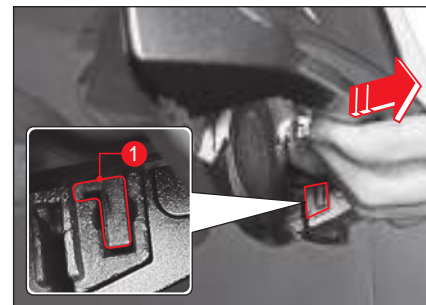

- 2 Press the Emergency key hole cover open button (1) using the emergency key.



- 3 With the Emergency key hole cover open button (1) pressed, push down the top side of the emergency key hole cover to remove it.



Caution

- Be careful not to create a scratch on the driver seat door panel or lose the emergency key hole cover.

- 4 Insert the emergency key into the key hole and do as follows.

- To lock the door, turn it in the lock direction (2).
- To unlock the door, turn it in the unlock direction (3).



Notice

- When unlocking in the theft monitoring mode, the warning buzzer sounds.

Starting the engine with the dead smart key or interference, etc. (in the event of emergency)

You may not be able to start the engine with the START/STOP switch due to the depletion of the battery in the smart key or interference even if you are carrying the smart key in the vehicle.

In such case, take a measure as follows, replace the smart key battery or check the smart key.

Place the gear shift lever in the P (parking) or the N (neutral) position and start the engine by pressing the START/STOP switch directly with the smart key with the brake pedal depressed.



Notice

- If the warning buzzer is sounding, it stops.
- If you open the door while the engine is running when the smart key battery is depleted, a warning message saying “The smart key is not in the vehicle” appears. In such case, when you turn off and start the engine again, the warning message disappears.

Replacing the smart key/rekes key battery

If the operation range of the smart key/rekes key has decreased significantly or the smart key/rekes key malfunctions occasionally, replace the smart key/rekes key battery.

Battery standard	One CR2032 battery
-------------------------	---------------------------

- 1 Remove the cover of the back of the smart key/rekes key carefully using a flat-bladed screwdriver for watches (smallest one) not to create a scratch.

4



- 2 Insert the battery with the positive (+) terminal facing up and the negative (-) terminal facing down.



- 3 Return the cover from the back of the smart key back to its original position.

After replacing the battery, be sure to check if the remote control key operates normally.



Caution

- The circuit inside the smart key/rekes key is vulnerable to static electricity, so if you are not skilled in replacing the battery, have the smart key/rekes key checked and the battery replaced at a KG Mobility Authorized Service Center.
- Be sure to replace the battery with one that meets the standard. Using a battery that does not meet the standard may cause the smart key/rekes key to be inoperable due to contact failure.
- Be careful not to switch the direction of the positive (+) terminal and negative (-) terminal when inserting the battery.
- Since the battery may contaminate environments, discard it in a proper way.

Instrument cluster

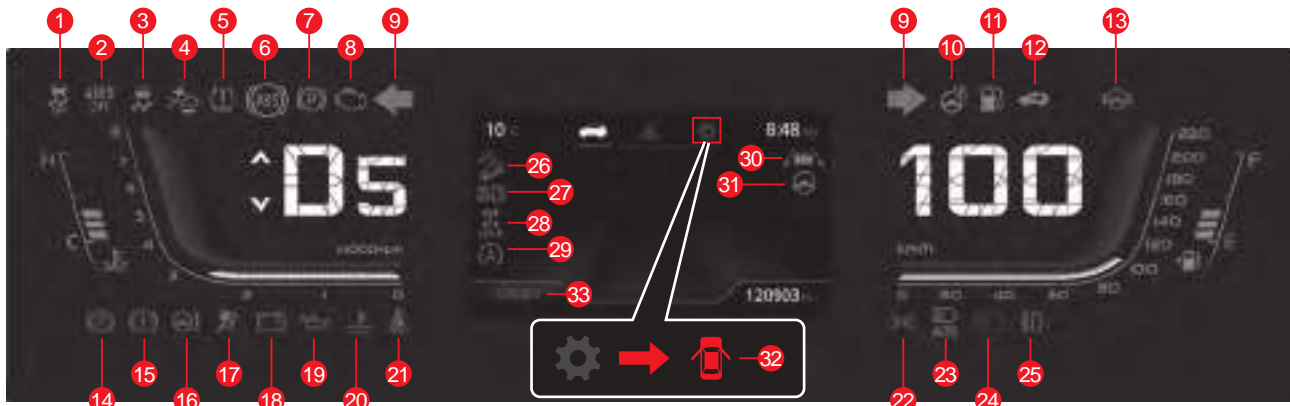

- 1 Electronic stability control (ESC) OFF indicator lamp
- 2 Autonomous emergency braking (AEB) OFF indicator lamp
- 3 Electronic stability control (ESC) ON indicator/warning lamp
- 4 Autonomous emergency braking (AEB) warning lamp
- 5 Global warning lamp
- 6 Anti-Lock brake system (ABS) warning lamp
- 7 Electronic parking brake (EPB) warning lamp
- 8 Engine CHECK warning lamp
- 9 Turn signal lamp/hazard warning lamp
- 10 Steering wheel heating ON indicator lamp
- 11 Low fuel level warning lamp
- 12 Immobilizer/Smart key warning lamp
- 13 Hands OFF warning lamp
- 14 Parking brake ON indicator (red)
- 15 Brake warning lamp
- 16 Electric power steering warning light
- 17 Air bag warning lamp
- 18 Charge warning lamp
- 19 Engine oil pressure warning light
- 20 Engine overheat warning lamp
- 21 Seat belt reminder warning lamp
- 22 Illumination ON indicator
- 23 Smart high beam (SHB) indicator lamp
- 24 High beam indicator
- 25 Front fog lamp
- 26 Hill descent control (HDC) ON indicator / warning lamp
- 27 AUTO HOLD indicator / warning lamp
- 28 4WD LOCK indicator and 4WD CHECK warning lamp
- 29 ISG indicator/warning lamp and ISG OFF indicator lamp
- 30 LKAS indicator lamp
- 31 Center lane keep assistance (CLKA) ON indicator lamp
- 32 Door ajar warning lamp
- 33 WINTER mode indicator and SPORT mode indicator

Driving Information Display

Engine RPM



It shows the engine's revolution per minute (RPM) in bar form.

Since one bar represents 1,000 rpm, multiply the number displayed by the bar by 1,000 to get the current engine rotation speed.

Notice

- There are a total of 8 bars for engine speed, and it can display up to 8,000 RPM.

Driving Speed

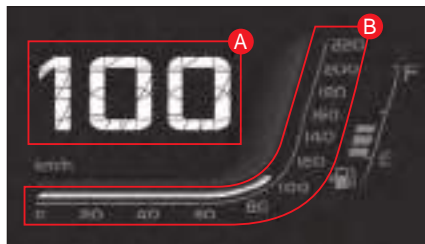

It displays the current speed of the vehicle in the form of both digital numbers (A) and a bar (B).

Caution

- Drive carefully and safely in school zones as unforeseen hazards may arise.

Over speed warning light (GCC only)



Sounds warning chime 5 times initially

Engine Coolant Temperature



This gauge indicates the engine coolant temperature.

Caution

- If the coolant thermometer gauge points near the engine overheating range (H) or the engine overheating warning lamp illuminates, immediately stop the vehicle in a safe place and cool down the engine. If the engine is overheated, continued operation of the vehicle may seriously damage the engine.

Fuel gauge



It displays the remaining fuel level when the START/STOP switch is in the ON status or the engine is running.

Refuel before the pointer of the fuel gauge reaches "E". If the low fuel level warning light turns on, refuel immediately.

The left arrow in the gas pump icon (◀🛢️) indicates that the fuel inlet is located on the left side of the vehicle.

Warning

- Be sure to stop the engine when refueling.

Caution

- If the vehicle is on a hillside road, the remaining fuel level may not be displayed accurately.
- Use only the designated fuel and approved additives. Failure to do so may cause contamination of the fuel tank or clogging of the fuel filter, damaging the engine.
- Drive the vehicle with a proper fuel level. Failure to do so may damage the catalytic converter due to the non-combustion or incomplete combustion of fuel.

Total mileage



The total mileage of the vehicle is displayed in kilometers. The maximum mileage to be displayed is 999999 km.

Notice

- It is normal if the total mileage at the time of shipping is less than 50 km.

Position of gear shift lever



It displays the current position (P, R, N, D) of the gear shift lever and the gear stage (1~6stages) in the M (manual) mode.

Gear position display in D (automatic) mode



In automatic shift mode, the current gear position is displayed depending on the driving condition.

Gear shift point indicator in manual mode



Gear shift point indicator is a supplementary function indicating the optimal shift point for fuel efficiency. The shift point may vary according to road and driving conditions.

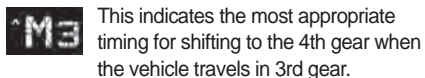

This indicates the most appropriate timing for shifting to the 4th gear when the vehicle travels in 3rd gear.

Notice

- While driving in M (manual) mode, the transmission may automatically shifts up to protect the system if the engine RPM gets high.
- In M (manual) mode, the arrows do not appear separately when downshifting while traveling in 2nd to 6th gears. Drive shifting manually according to driving conditions. If driving without manual shift, RPM will get low and the system will shift down.
- Gear shift point indicator differs and may not be available depending on vehicle specifications.

Manual transmission display



Gear shift point indicator is a supplementary function indicating the optimal shift point for fuel efficiency. The shift point may vary according to road and driving conditions.

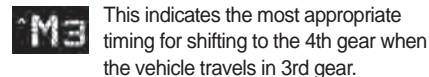

This indicates the most appropriate timing for shifting to the 4th gear when the vehicle travels in 3rd gear.

Notice

- Drive shifting manually according to driving conditions.
- Gear shift point indicator differs and may not be available depending on vehicle specifications.

Warning lights and indicators

Seat belt warning lamp



If the driver seat and front passenger seat occupants do not fasten the seat belt, the seat belt warning light blinks along with a warning buzzer.

If you fasten the seat belt at this time, the warning buzzer stops and the seat belt warning light stays on for the remaining time.

☞ Refer to "Seat belt warning" (p.2-2)

Air bag warning lamp



The air bag warning lamp turns on when the START/STOP switch is in the ON status, and it turns off when there is no abnormality in the air bag system.

If the warning light stays on after starting the engine, the air bag system is abnormal. Have your vehicle checked and serviced at a KG Mobility Authorized Service Center immediately.

☞ Refer to "Air bag" (p.2-20)

Engine oil pressure warning light



The engine oil pressure warning light turns on when the START/STOP switch is in the ON status and it turns off when the engine is started.

This warning light turns on when the engine oil is insufficient or the engine lubrication system is abnormal.

When this warning light turns on while driving, park your vehicle at a safe place, check the engine oil level and add engine oil immediately if it is insufficient.

☞ Refer to "Replenishment" (p.6-9)

Caution

- If the warning light stays on after the engine oil is added, stop driving the vehicle immediately and have your vehicle checked and serviced at a KG Mobility Authorized Service Center.
- Driving the vehicle continuously with the engine oil pressure warning light turned on may damage the engine significantly.

Charge warning light



The charge warning light turns on when the vehicle battery is depleted or the charging system is abnormal.



Caution

- If the charge warning light turns on, it indicates that the charging system is abnormal. Have your vehicle checked and serviced at a KG Mobility Authorized Service Center.

Notice

- Even if the charge warning light does not turn on, the engine may not be started if the battery is not charged smoothly due to insufficient tension of the engine fan belt.

Immobilizer/smart key warning light



If the smart key system is abnormal or the smart key (transponder) authentication fails, the warning light blinks.



Caution

- If the warning light blinks continuously, have your vehicle checked and serviced at a KG Mobility Authorized Service Center.

Engine overheat warning lamp



If the temperature of the engine coolant is abnormally high, the engine overheat warning lamp blinks and the warning buzzer sounds.

If this warning light turns on, park your vehicle at a safe place immediately and cool down the engine.

 Refer to "When the engine is overheated so that the warning light turns on" (p.5-6)



Caution

- If the engine coolant temperature gauge points out near the engine overheating range (H), park your vehicle at a safe place immediately and cool down the engine.
- Driving the vehicle continuously with an overheated engine may damage the engine significantly. Cool down the engine properly and have your vehicle checked and serviced at a KG Mobility Authorized Service Center.

Electric power steering warning light



The electric power steering warning light turns on when the ignition switch is turned on and turns off when the ignition is turned on.

This warning lamp lights on in the event of faulty electric power steering (EPS) system.



Caution

- If the electric power steering warning light comes on or the steering wheel feels heavy, please have it checked and serviced a KG Mobility Dealer or KG Mobility Authorized Service Center.

Notice

- If you keep the steering wheel turned to the left or right all the way while the vehicle is stationary, the warning light will blink as the steering wheel becomes heavy. This is a safety feature to protect the system and will return to normal after some time.
- The EPS (Electronic Power Steering) system is mounted in the steering handle. This system includes functions to compensate the steering power, interlocking with ESC, the supplementary driving safety system, when cornering or braking on the road with different friction. You may feel some difference in steering when these functions are in operation.

Parking brake ON indicator (red)



The parking brake ON indicator comes on when the parking brake is applied.

ABS (Anti-Lock Brake System) warning light



The ABS warning light turns on when the START/STOP switch is in the ON status and turns off approximately 4 seconds later.

This warning light turns on when the ABS system is abnormal.



Warning

- If the ABS warning light turns on, the ABS function does not operate and only normal brake function operates. In such case, have your vehicle checked and serviced at a KG Mobility Authorized Service Center immediately.

Notice

- A vehicle equipped with the ABS system has the self-diagnosis function to check the internal hydraulic system to see if there is an abnormality by transferring the hydraulic pressure to the internal hydraulic system after the engine is started. At this time, a vibration and a noise may occur at the brake pedal. This indicates that the ABS is functioning normally.

Brake warning lamp



When the ignition switch is in the "ON" position, the electronic brake-force distribution (EBD) warning lamp comes on and then goes out after about 4 seconds.

If the EBD (Electronic Brake-Force Distribution) system is faulty its warning lamp comes on.

In such case, drive the vehicle carefully since the vehicle may become unstable if you apply sudden braking.



Warning

- If the EBD warning light turns on, have your vehicle checked and serviced at a KG Mobility Authorized Service Center immediately.
- If the EBD warning light turns on, the EBD function as well as the ABS function do not operate.
- Driving the vehicle continuously with insufficient brake fluid lowers the brake performance since the pressure of brake fluid cannot be transferred normally.

Notice

Driving the vehicle with insufficient brake fluid causes the brake warning light to operate as follows.

- Turn on: When driving the vehicle at a speed of approximately 10 km/h or less
- Blink: When driving the vehicle at a speed of approximately 10km/h or higher for 2 seconds or more

Electronic Parking Brake (EPB) warning light



The Electronic Parking Brake (EPB) warning light turns on when the START/STOP switch is in the ON status and turns off approximately 4 seconds later.

The amber warning light will come on in the event of the faulty electric parking brake (EPB) system.



Warning

- If the Electronic Parking Brake (EPB) warning light turns on, have your vehicle checked and serviced at a KG Mobility Authorized Service Center.
- If you need to park the vehicle with the parking brake not functioning due to the failure of the Electronic Parking Brake (EPB) in an emergency, stop the vehicle on safe flat ground and place the gear shift lever in the P (parking) position.

AUTO HOLD indicator/warning light



When you press the AUTO HOLD button, the AUTO HOLD system enters the ready mode and the white AUTO HOLD indicator on the instrument cluster turns on.

When you press the AUTO HOLD button again, the AUTO HOLD indicator turns off and the AUTO HOLD system is deactivated.

The color of the AUTO HOLD indicator changes as follows according to the status.

- White indicator: AUTO HOLD system in ready mode
- Green indicator: AUTO HOLD system is activated
- Yellow indicator: AUTO HOLD system is abnormal



Warning

- If the yellow warning light turns on, have your vehicle checked and serviced at a KG Mobility Authorized Service Center.

Engine check indicator

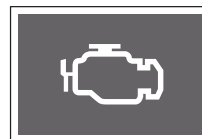

The engine check indicator turns on when the START/STOP switch is in the ON status and turns off the engine is started.

This indicator turns on when various sensors and devices related to engine control (including automatic transmission) are abnormal.



Warning

- If the engine check indicator turns on when you stop the engine, refuel and drive the vehicle again due to an empty fuel tank, the power output may decrease while driving for a certain distance (approximately 30 km).
- If the engine check indicator turns on while driving or occasionally, have your vehicle checked and serviced at a KG Mobility Authorized Service Center.
- If the engine check indicator turns on, the driving performance of the engine may decrease or the engine may stall. This symptom indicates that the vehicle enters the system safety mode in order to protect the vehicle systems. In such case, have your vehicle checked and serviced at a KG Mobility Authorized Service Center.

Steering wheel heater indicator*



If you press the Steering wheel heater button with the START/STOP switch in the ON status or while the engine is running, the steering wheel heater indicator turns on or turns off.

Notice

- When the steering wheel heater indicator turns on, the heater ON/OFF status message is displayed on top of the display of the instrument cluster for approximately 5 seconds.

Electronic stability control system (ESC) ON indicator/warning light



The ESC ON indicator turns on when the START/STOP switch is in the ON status and turns off approximately 4 seconds later.

- Indicator blinks: When the ESC function is activated
- Warning light turns on: When the ESC system is abnormal



Caution

- If the ESC ON warning lamp turns on, have your vehicle checked and serviced at a KG Mobility Authorized Service Center.

Electronic stability control system (ESC) OFF indicator



The ESC OFF indicator turns on when the START/STOP switch is in the ON status and turns off approximately 4 seconds later.

Pressing and holding down the ESC OFF switch (approximately 3 seconds or more) deactivates the ESC function and the ESC OFF indicator turns on.

☞ Refer to “When it is necessary to deactivate the ESC function” (p.4-140)

Low fuel level warning light



If the remaining fuel level is insufficient, the low fuel level warning light turns on. However, the time for the warning light to turn on may vary depending on the vehicle status or the degree of slope.

Refuel before the low fuel level warning light turns on if possible.

If this warning light turns on, do not drive the vehicle for a long distance and refuel immediately.

☞ Refer to "Fuel inlet" (p.3-34)

Notice

- If you drive the vehicle on a steep road or a bumpy road with low fuel level, the low fuel level warning light may turn on.

Global warning light



The global warning light turns on when the START/STOP switch is in the ON status and turns off approximately 4 seconds later.

If the tire pressure monitoring system (TPMS) is abnormal, the global warning light blinks (for approximately 70 seconds) and then stays on. This warning light also turns on if the tire pressure is abnormal (underinflated/overinflated/flat).

☞ Refer to "Tire pressure monitoring system (TPMS)" (p.2-29)



Warning

- If the global warning light turns on, be sure to park your vehicle at a safe place and check the tire pressure. If this warning light stays on, have your vehicle checked and serviced at a KG Mobility Authorized Service Center.

Autonomous Emergency Braking (AEB) warning light



The AEB warning light turns on when the START/STOP switch is in the ON status and turns off approximately 4 seconds later.

If the collision with a front vehicle is expected with the AEB function activated, the AEB warning light operates as follows along with a warning buzzer.

- Blink: The AEB is operating (It operates for 5 second when a collision warning is given.)
- Turn on: The AEB is abnormal

☞ Refer to "Autonomous Emergency Braking (AEB)" (p.4-148)

Autonomous Emergency Braking (AEB) OFF indicator



The AEB OFF indicator turns on when the START/STOP switch is in the ON status and it turns off approximately 4 seconds later.

When the AEB is deactivated and the ESC function is disabled, the AEB indicator turns on, stopping the AEB operation.

Hill Descent Control (HDC) ON indicator/warning light



When you press the HDC switch, the system is switched to the HDC operation ready status and the green HDC indicator turns on.

When you press the HDC switch again, the indicator turns off and the HDC function is deactivated.

The HDC ON indicator operates as follows according to the status.

- Green indicator turns on: The HDC is in ready status.
- Green indicator blinks: The HDC is operating.
- Red warning light turns on: The HDC system is overheated and abnormal.

☞ Refer to "Hill Descent Control (HDC)" (p.4-141)



Caution

- **When the red warning light turns on, have your vehicle checked and serviced at a KG Mobility Authorized Service Center.**

LKA (LDW) indicator / warning lamp*



Pressing the lane keeping assistance (departure) switch activates the lane keeping and lane departure alerts depending on the vehicle setting.

- White indicator turns on: The lane departure system is in ready status.
- Green indicator turns on: The lane departure system is operating normally.
- Yellow warning light turns on: The lane departure system is abnormal.

☞ Refer to "LDW (Lane Departure Warning)"* (p.4-165)

☞ Refer to "LKA (Lane Keeping Assistance)"* (p.4-169)



Warning

- **If the yellow warning light turns on or blinks, have your vehicle checked and serviced at a KG Mobility Authorized Service Center.**

Centering lane keeping assist (CLKA) indicator / warning lamp



The centering lane keeping assist (CLKA) ON indicator comes on and CLKA is activated.

- White indicator illuminated: system in standby
 - Green indicator illuminated: system normal operation
 - Yellow warning lamp illuminated: faulty system
- ☞ Refer to “Centering Lane Keeping Assist (CLKA)” (p.4-176)



Warning

- **If the amber warning lamp is lit or flashes, have the vehicle checked and serviced at a KG Mobility Dealer or KG Mobility Authorized Service Center.**

Illumination ON indicator

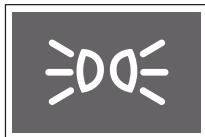

When you turn on the head light or the tail light using the light switch, the illumination ON indicator turns on.

Front fog lamp ON indicator*



When you place the light switch in  (front fog light) position with the head light or the tail light turned on, the front fog light turns on and the indicator turns on.

For a vehicle equipped with the Daytime Running Light (DRL), when you place the light switch in the  (front fog light) position with the switch in the ON status, the front fog light turns on.

Rear fog lamp ON indicator*



With the headlights turned on, if you rotate the switch in  position, rear fog lights turn on and the switch returns back in front fog light position. Rear and front fog lights turn on simultaneously.

SHB indicator*



The SHB indicator turns on when the START/STOP switch is in the ON status and turns off approximately 4 seconds later.

When you push the switch in the direction of the instrument cluster with the light switch in the AUTO position, the SHB is activated and the indicator turns on.

☞ Refer to “Smart High Beam (SHB)**” (p.3-41)



Caution

In any of the following cases, the SHB may not operate normally.

- When the vehicle windshield is damaged or contaminated by dust, mist, fog, sticker, snow, etc
- When the lamp of an oncoming vehicle or a vehicle at the front is damaged
- When an oncoming vehicle or a vehicle at the front is out of your front sight
- When an oncoming vehicle and a vehicle at the front are recognized only partially in an intersection or a winding road
- When there is a light source similar to a vehicle lamp or a reflector at the front
- When an illuminator or a reflector is installed in a construction section, etc.

High beam indicator



When you push the light switch in the direction of the instrument cluster and release it, the high beam turns on and the high beam indicator turns on.



Warning

- Driving the vehicle with the high beam turned on may block the vision of the driver in an oncoming vehicle and interfere with safe driving. Therefore, use the high beam only if the surrounding is too dark or it is difficult to predict the front situation when you drive at night.

Turn signal/hazard warning lamp

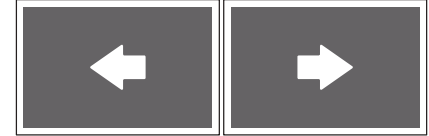

- When you push the light switch down, the left turn signal blinks.
- When you push the light switch up, the right turn signal blinks.
- When you push the hazard warning lamp switch, the left and right turn signals blink at the same time.

WINTER / SPORT indicator lamp



Pressing the drive mode switch in normal driving condition will change the mode as follows:

- NORMAL → SPORT → WINTER → NORMAL

WINTER mode is a function to minimize slippage when starting off on the slippery road surface in winter.



Caution

- If both the WINTER and SPORT mode indicators are lit simultaneously because of the system failure, have the system checked and serviced by a KG Mobility Dealer or KG Mobility Authorized Service Center.

Notice

- There is no indicator lamp for NORMAL driving.

Hands OFF warning lamp*



If the driver releases his/her hands from the steering wheel for a certain period of time during LKA and Intelligent Cruise Control operation, a beep sounds and the warning light turns on.

Notice

- The hands OFF warning lamp is fitted only to the vehicles with standard type.

ISG indicator/warning lamp*



Depending on the ISG operation status, the ISG indicator and warning lamp are operated as follows:

- Green indicator ON : Engine stops due to system operation
- Amber warning lamp ON : faulty ISG system



Caution

- If the amber warning lamp is lit, have the vehicle checked and serviced at a KG Mobility Dealer or KG Mobility Authorized Service Center.

ISG OFF indicator*



When you press the ISG ON/OFF switch, the indicator is lit. Press the switch again to turn off the indicator.

If you do not want to use the ISG system, press the ISG ON/OFF switch to turn off the ISG system.

4WD CHECK warning lamp*



The 4WD CHECK warning lamp is turned on and then off after about 4 seconds when the ignition switch is turned on.

- **ON**
 - Turns on when there is a temporary error in the 4WD system or an error in the related system.
 - A temporary error is resolved after a period of time or when the engine is restarted. In this case, the 4WD system is normal.
- **Blinks**
 - The 4WD CHECK warning lamp blinks to prevent damage to the 4WD system due to overheating. If the warning lamp blinks, immediately stop using the accelerator pedal and allow the 4WD system to cool down sufficiently.
 - If the 4WD system is sufficiently cool and the warning lamp no longer flashes, the 4WD system will operate normally.

4WD LOCK ON indicator*

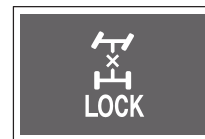

The 4WD LOCK indicator is turned on and then off after about 4 seconds when the ignition switch is turned on.

Pressing the 4WD LOCK switch turns on the 4WD LOCK indicator.

Pressing the 4WD LOCK switch again turns off the indicator and disables 4WD LOCK.

Over speed warning light (GCC only)



The warning light flashes with repeated (5 times) buzzer sound when the vehicle speed exceeds 120 km/h.

If the warning light flashes, slow down for your own safety.

Door open warning light



The door open warning light turns on when a door or the tailgate is opened or not closed completely.

Warning

- **Confirm that all doors and the tailgate are closed completely before driving. Driving the vehicle with a door or the tailgate opened may cause a serious risk to the safety of occupants.**

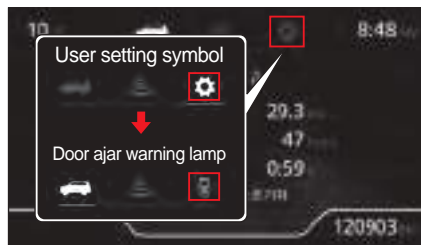

If the door or tailgate is open or not fully closed, the LCD screen (user setting symbol position) will display the door ajar warning lamp.

(User setting symbol changed to door ajar warning lamp)

Master symbol



If the vehicle has a warning message, the master symbol will illuminate.

If the master symbol is illuminated, be sure to check the vehicle warning message.





Notice

- You can check the vehicle warning message(s) in the User Settings in the instrument cluster.
- When the warning message is not found, the corresponding item is not displayed.



Indicator panel on instrument cluster

Main menu

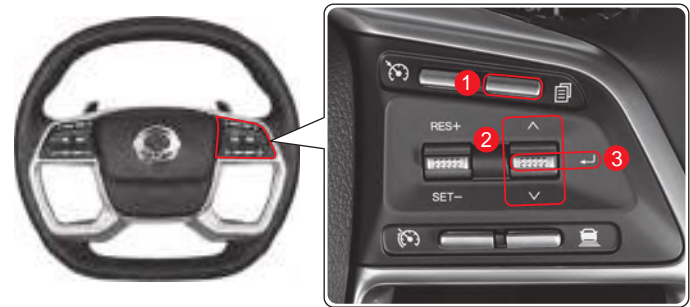

You can check the driving information of the vehicle including mileage and driving time or change the settings through the main menu from the display of the instrument cluster.

- 1 Press the  (menu) button on the right side of the steering wheel.
 - The display moves to the main menu list.
 - Go to upper menu when entering User Settings menu.
- 2 Move to the desired submenu by raising or lowering the  (moving) lever.
- 3 Press the  (select) button briefly to enter the menu, change the setting and confirm.
Pressing and holding down the  (selection) button resets the driving information of the vehicle.



Button and lever	Operation	Function
 Menu button	Press briefly	<ul style="list-style-type: none">• Move to the main menu• Go to upper menu when entering User Settings menu
 Moving lever	Raise/lower briefly	<ul style="list-style-type: none">• Move to the submenu (mode)
 Selection button	Press briefly	<ul style="list-style-type: none">• Enter the menu• Check/select the setting
	Press and hold down	<ul style="list-style-type: none">• Reset the driving information of the vehicle

Main menu list

Main menu	Description
 Trip computer information	<ul style="list-style-type: none"> • Drive Range/AVG. Fuel/Instantaneous fuel economy display • Driving Distance A/AVG. Speed/Driving Time • Driving Distance B/AVG. Speed/Driving Time • After Departure • ISG cumulative time display (AUTO STOP) • Media display • Display the status of the tire pressure monitoring system (TPMS)
 Driving assist Menu	<ul style="list-style-type: none"> • Driver assistance system operation status display • Driver attention alert level display
 User settings	<ul style="list-style-type: none"> • Driving Assist <ul style="list-style-type: none"> • Sound • Door/Tailgate <ul style="list-style-type: none"> • Dashboard Settings & Info • Light <ul style="list-style-type: none"> • Reset All Settings • Convenience

Trip computer information

Distance to empty/average fuel economy/Instantaneous fuel economy

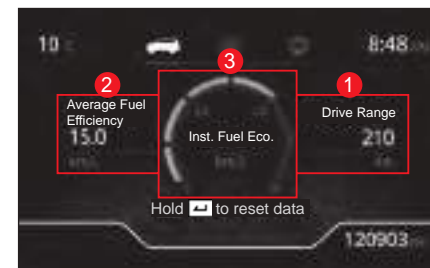

1 Distance to empty

The distance that the vehicle can travel calculated based on the remaining fuel level, average fuel economy and accumulated driving pattern is displayed.

The display range is between 0 km and 1,500 km and “----” blinks if the distance to empty is less than 50 km.

Caution

- Actual fuel level remaining in the fuel tank may be different from the fuel level calculated by the trip computer due to factors including the horizontal condition and driving conditions of the vehicle. Use the distance to empty only for reference purpose and refuel before the low fuel level warning light turns on.

2 Average fuel economy

The average fuel economy calculated using the total amount of fuel used and the mileage since it was reset to "--.--" is displayed.

It indicates the distance (km) traveled using 1 liter of fuel, and the value on the screen is updated every 10 seconds.

The average fuel efficiency is calculated continuously as long as the engine is running even if the vehicle is not actually driven.

3 Instantaneous fuel economy

The instantaneous fuel economy is calculated based on the mileage and the amount of fuel consumption.

The display range is between 0 and 30 km/l.

Resetting the average fuel economy

Press and hold down the  (select) button in the current mode.

The average fuel economy is reseted and "--.--" is displayed, and when the vehicle is driven for a certain distance, the average fuel economy is displayed.

Notice

- **You can set the fuel economy to reset according to the vehicle condition (when starting the engine, when refueling). You can set Average fuel consumption auto reset at Dashboard Settings & Info → Fuel Economy Reset → Reset After Refueling or Reset After Ignition under  (User Settings) in the instrument cluster.**

Mileage/average speed/driving time

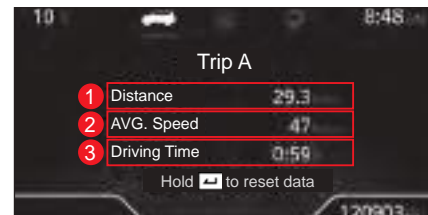

1 Mileage (A/B)

The distance that the vehicle traveled (km), average speed (km/h) and driving time (hh:mm) are displayed.

The distance to be displayed ranges between 0.0 km and 9999.9 km.

When the distance exceeds 9999.9 km, it returns to 0.0 km.

2 Average speed (A/B)

The average speed calculated based on the time and distance and it is updated every 10 seconds.

3 Driving time (A/B)

The time to be displayed ranges between 0:00 and 99:59, and when the time exceeds this range, it returns to 0:00.

Resetting the mileage/average speed/driving time

Press and hold down the  (select) button in the current mode.

The average speed is reseted to "--" and the driving time is reseted to "0:00".

Driving information after departure

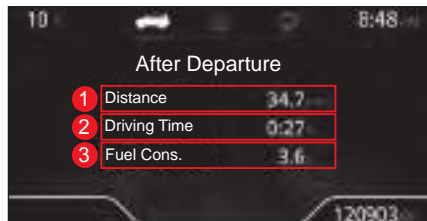

Distance driven (km) after the start-up, driving time (HH:MM) and fuel consumption (L) are displayed.

1 After departure

Total accumulated distance traveled after the engine is started is displayed.

The distance to be displayed ranges between 0.0 km and 9999.9 km.

2 Driving time

The time to be displayed ranges between 0:00 and 99:59, and when the time exceeds this range, it returns to 0:00.

3 Fuel consumption

The total amount of fuel used after the engine is started is displayed in liters (L).

Reset of departure time / driving time / fuel consumption

The information resets automatically when you turn off the engine and start the engine again.

ISG cumulative time



1 ISG cumulative time

Displays the cumulative ISG OFF time (engine stop) by the ISG system after startup.

Reset of ISG cumulative time

Press and hold the  (select) switch in current mode.

The ISG cumulative time is reset as "00:00:00".

Media Display



The audio (AV) screen is displayed in conjunction with the audio (AV) system.

The image that appears in the upper main menu depends on the mode or function you are currently using.

TPMS status

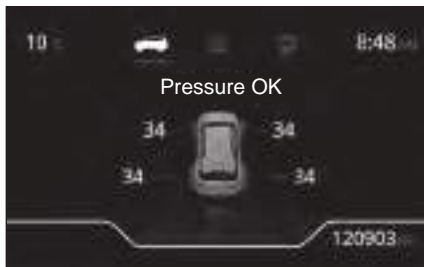

A message indicating the status of tire pressure is displayed.

- If the tire pressure is normal, "Tire pressure OK" is displayed.
- If the tire pressure is abnormal, the corresponding message according to the degree of abnormal tire pressure is displayed, and this message stays on or blinks depending on the tire pressure condition.

☞ Refer to "Tire pressure monitoring system (TPMS)" (p.2-29)

Notice

- **Approximately 15 seconds after entering the tire pressure mode, it will automatically switch to "Distance to empty / Average fuel economy / Instant fuel economy" mode.**

Driving assist Menu

Driving assist



When detecting the lanes according to the vehicle condition, the detected lane is displayed in white and alarm can be issued at the detected lane.

Depending on the operating system, the front vehicle is displayed.

The following are the systems that can display the front vehicle in the driving assistance menu:

- Lane Departure Warning (LDW)
- Lane Keeping Assist (LKA)
- Centering Lane Keeping Assist (CLKA)
- LKA hands-off display
- Auto cruise
- Adaptive cruise control (ACC)
- Intelligent Adaptive cruise control (iACC)

Driver attention alert



The driver's "Cautious driving level" is displayed in 5 steps and the driver can determine the his/her own current cautious driving level.

The "Cautious driving level" is lowered to a poor level according to the driver's travel pattern analysis and when driving for a long period of time without rest.

User settings

※ The menu configuration may vary according to the instrument panel specifications.

Setting menu	Level 1	Level 2	Level 3
Driving Assist	Front Safety Aid	Autonomous Emergency Braking (AEB) <input checked="" type="checkbox"/>	Tick/Not tick (AEBS OFF warning lamp lights on when unticked)
		Forward Collision Sensitivity	Slow <input type="checkbox"/> Medium <input checked="" type="checkbox"/> Fast <input type="checkbox"/>
		Speed Limit Warning <input checked="" type="checkbox"/>	Tick/Not tick
		LDW & LKA Setting	Lane Departure Warning (LDW) <input type="checkbox"/> Lane Keeping Assist (LKA) <input checked="" type="checkbox"/> Emergency Lane Keeping (ELK) <input checked="" type="checkbox"/>
		Adaptive Cruise Level	COMFORT <input type="checkbox"/> NORMAL <input checked="" type="checkbox"/> DYNAMIC <input type="checkbox"/>
		Intelligent Adaptive Cruise <input checked="" type="checkbox"/>	Tick/Not tick
		Front Vehicle Start Warning (FVSW) <input checked="" type="checkbox"/>	Tick/Not tick
		Driver Attention Warning (DAW) <input type="checkbox"/>	Tick/Not tick
		Safety Distance Warning (SDW) <input type="checkbox"/>	Tick/Not tick
		HELP	-

Setting menu	Level 1	Level 2	Level 3
Driving Assist	Rear Side Safety Aid	Rear Side Warning and Collision Assist	OFF <input type="checkbox"/> Collision Warning <input type="checkbox"/> Collision Assist <input checked="" type="checkbox"/>
		Rear Cross Traffic Warning & Collision Assist	OFF <input type="checkbox"/> Collision Warning <input type="checkbox"/> Collision Assist <input checked="" type="checkbox"/>
		Safety Exit Warning (SEW)	OFF <input type="checkbox"/> ON <input checked="" type="checkbox"/>
		HELP	

Setting menu	Level 1	Level 2	Level 3
Door/Tailgate	Auto Lock	Off <input type="checkbox"/> Driving <input checked="" type="checkbox"/> Shifting to R,N,D <input type="checkbox"/>	
	Auto Unlock	Off <input type="checkbox"/> Engine Off <input checked="" type="checkbox"/> Shifting to P <input type="checkbox"/>	
	Auto Lock Speed Setting	10km/h <input type="checkbox"/> 20km/h <input type="checkbox"/> 30km/h <input checked="" type="checkbox"/> 40km/h <input type="checkbox"/> 50km/h <input type="checkbox"/>	
	Lock/Unlock Sound <input checked="" type="checkbox"/>	Tick/Not tick	
	Press key twice to unlock <input checked="" type="checkbox"/>	Tick/Not tick	
	Smart Door Auto Lock <input checked="" type="checkbox"/>	Tick/Not tick	
	Power Tailgate <input type="checkbox"/>	Tick/Not tick	
	Smart Tailgate <input type="checkbox"/>	Tick/Not tick	
	HELP	-	





Setting menu	Level 1	Level 2	Level 3
Light	Leaving-Home Headlamp	Deactivate <input type="checkbox"/>	
		10 sec. <input type="checkbox"/>	
	Coming-Home Headlamp	20 sec. <input type="checkbox"/>	
		30 sec. <input type="checkbox"/>	
	HELP	-	
Convenience	Steering Wheel Alignment Alert <input checked="" type="checkbox"/>	Tick/Not tick	
	Wiper Mode Display <input checked="" type="checkbox"/>	Tick/Not tick	
	Light Mode Display <input checked="" type="checkbox"/>	Tick/Not tick	
	Approach Welcome <input type="checkbox"/>	Tick/Not tick	
	Auto Approach Welcome <input type="checkbox"/>	Tick/Not tick	
	Long-Term Parking <input type="checkbox"/>	Tick/Not tick	
	Wireless Charging System <input type="checkbox"/>	Tick/Not tick	
	HELP	-	
Sound	Welcome & Goodbye Sound <input checked="" type="checkbox"/>	Tick/Not tick	
	HELP	-	





※ Some of the following menus may not be supported depending on the instrument cluster specifications.

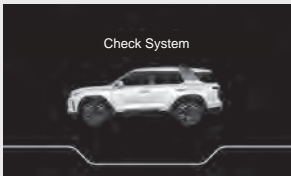
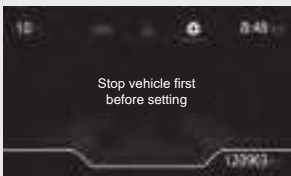

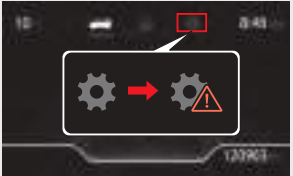

Setting menu	Level 1	Level 2	Level 3
Dashboard Settings & Info	Fuel Economy Reset	OFF <input checked="" type="checkbox"/>	
		Reset After Refueling <input type="checkbox"/>	
		Reset After Ignition <input type="checkbox"/>	
	Fuel Economy Unit	km/L <input checked="" type="checkbox"/>	
		L/100km <input type="checkbox"/>	
Temperature Unit	°C <input checked="" type="checkbox"/>		
	°F <input type="checkbox"/>		
Tire Pressure Unit	psi <input checked="" type="checkbox"/>		
	kPa <input type="checkbox"/>		
	bar <input type="checkbox"/>		
	kgf/cm ² <input type="checkbox"/>		
HELP		-	
Reset All Settings	Yes/No	-	-

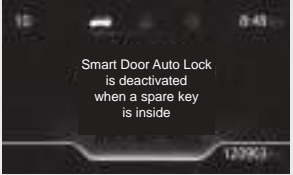

Message on the display of the instrument cluster

The images in the below messages are based on the standard instrument cluster for visibility and depend on the instrument panel specifications.

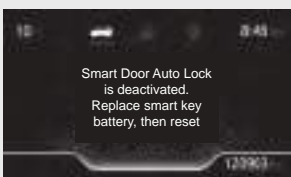
Item	Message	Activation conditions
Welcome message and sound		<ul style="list-style-type: none"> If you tick the box at Sound → Welcome & Goodbye Sound display under  (User Settings) in the instrument cluster, this message is displayed for 4 seconds when the theft deterrent mode is deactivated and the driver door is open and closed. When you change the START/STOP switch to the ON status while the message is being displayed, the message disappears but the sound is played to the end.
Check System		<ul style="list-style-type: none"> This message is displayed once for 4 seconds when the START/STOP switch is in the ON status. If the message persists, visit a nearby KG Mobility Authorized Service Center.
Instrument cluster settings		<ul style="list-style-type: none"> If a vehicle speed is detected when you enter the User Settings menu and carry out the detailed setting, the relevant warning message is displayed for approximately 5 seconds. However, the instrument cluster illumination, driving assist and vehicle warning menu are excluded.
ICE warning light		<ul style="list-style-type: none"> The ICE warning pop-up is displayed as a pop-up message for 5 seconds when the ambient temperature falls 3°C or below. The ICE warning pop-up is only displayed once for the first time when turning ignition switch to "IGN ON". If there is no temperature change (temperature condition for deactivation), the pop-up is not displayed again. ICE warning symbol is turned off when the ambient temperature is 5°C or higher.



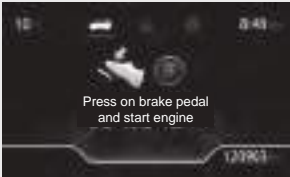
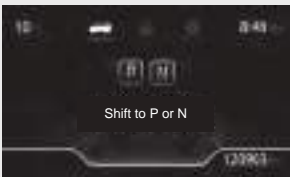
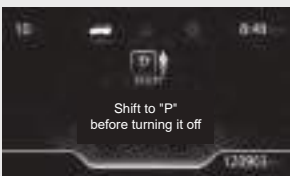



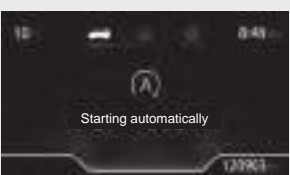
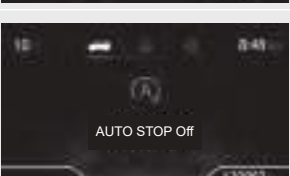
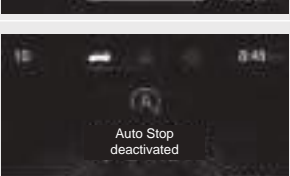

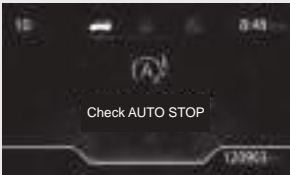















Item	Message	Activation conditions
Vehicle warning log		<ul style="list-style-type: none"> You can see the vehicle warning messages from  (User Settings) on the instrument cluster. <ul style="list-style-type: none"> When the warning message is available at the vehicle, the custom symbol is changed to the master symbol. When the warning message is not available, the corresponding item is not displayed.
Smart key warning		<ul style="list-style-type: none"> When you about to close the door with another authenticated smart key or door handle switch while all the doors are closed and the authenticated smart key is inside the vehicle, this message will be displayed for 5 seconds.
		<ul style="list-style-type: none"> If two or more authenticated smart keys are in the vehicle when a door is opened (excluding the engine hood and tailgate) after the engine is turned off, this message is displayed for approximately 5 seconds.
		<ul style="list-style-type: none"> If no smart key is in the vehicle with the START/STOP switch in the ON status or when the engine is running, this message is displayed.







Item	Message	Activation conditions
Smart key warning	 <p>Press START with smart key</p>	<ul style="list-style-type: none"> If no authenticated smart key is detected when the START/STOP switch is pressed, this message is displayed for approximately 5 seconds.
	 <p>Check smart key system</p>	<ul style="list-style-type: none"> If the vehicle power control from the smart key module or the START/STOP switch is abnormal or an incorrect signal or no signal is received after the smart key is authenticated, this message is displayed for approximately 5 seconds. If the message persists, visit a nearby KG Mobility Authorized Service Center.
	 <p>Replace smart key battery</p>	<ul style="list-style-type: none"> If the battery level of the smart key is low with the auto lock function disabled, this message is displayed for approximately 5 seconds.
	 <p>Smart Door Auto Lock is deactivated. Replace smart key battery, then reset</p>	<ul style="list-style-type: none"> If the battery level of the smart key is low with the auto lock function enabled, this message is displayed for approximately 5 seconds. If you attempt to set the auto lock function using the smart key when the battery level of the smart key is low, this message is displayed for approximately 5 seconds. If the message is displayed, the auto lock is disabled. After replacing the smart key battery, tick the box at Door / Tailgate → Smart door auto lock under  (user settings) in the instrument cluster.



Item	Message	Activation conditions
START/STOP switch warning	 <p>Press on brake pedal and start engine</p>	<ul style="list-style-type: none"> For the vehicles with A/T, when the ignition switch is turned to ACC position a second time by pressing the ignition switch continuously without depressing the brake pedal, this message is displayed for about 5 seconds. This message informs the driver that the engine can be started only if the START/STOP switch is pressed with the brake depressed.
	 <p>Shift to P or N</p>	<ul style="list-style-type: none"> This message is displayed for approximately 5 seconds when you start the engine with the gear shift lever not in the P (parking) or the N (neutral) position. This message informs the driver that the START/STOP switch should be pressed after the gear shift lever is placed in the P (parking) or the N (neutral) position.
	 <p>Shift to "P" before turning it off</p>	<ul style="list-style-type: none"> This message is displayed for approximately 5 seconds when you attempt to start the engine with the gear shift lever not in the P (parking) position. This message informs the driver that the engine can be turned off only when the START/STOP switch is pressed with the gear shift lever in the P (parking) position.
	 <p>Turn it off to prevent battery drain</p>	<ul style="list-style-type: none"> This message is displayed for approximately 5 seconds in order to prevent the vehicle battery from being depleted when the START/STOP switch in the ACC status is maintained for 12 minutes or more or the driver seat door is opened with the START/STOP switch in the ACC status.



Item	Message	Activation conditions
ISG System	 <p>A digital display showing the text "AUTO STOP" and "23:41" below it. The display is part of a larger dashboard interface with various icons and a battery level indicator at the top.</p>	<ul style="list-style-type: none"> The message indicating the cumulative time that the engine has stopped is displayed while the ISG system is normally operating.
	 <p>A digital display showing the text "Starting automatically". The display is part of a larger dashboard interface with various icons and a battery level indicator at the top.</p>	<ul style="list-style-type: none"> This message is displayed when the engine stops and then is automatically restarted while the ISG system is normally operating.
	 <p>A digital display showing the text "AUTO STOP Off". The display is part of a larger dashboard interface with various icons and a battery level indicator at the top.</p>	<ul style="list-style-type: none"> When you press the ISG OFF button, the ISG system stops operating and the system OFF message is displayed for about 5 seconds. However, the indicator on the ISG OFF button will light even if the corresponding message is not displayed according to the pop-up priority.
	 <p>A digital display showing the text "Auto Stop deactivated". The display is part of a larger dashboard interface with various icons and a battery level indicator at the top.</p>	<ul style="list-style-type: none"> If the current status of the vehicle does not meet the ISG system operating conditions, this message is displayed.





Item	Message	Activation conditions
ISG System		<ul style="list-style-type: none"> The message is displayed when the engine stops and is not automatically restarted depending on the vehicle status while the ISG system is normally operating.
		<ul style="list-style-type: none"> This message is displayed in the event of the faulty ISG system. If the message stays on, have the system checked and serviced at a nearest KG Mobility Authorized Service Center.

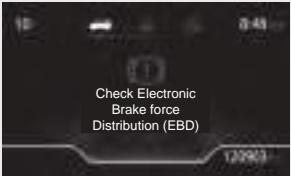
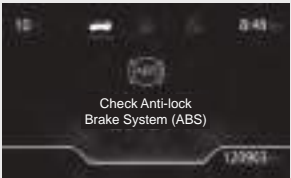

Item	Message	Activation conditions												
Front/rear obstacle detection	<p data-bbox="272 185 576 213">If it is in the R (reverse) position</p> <div data-bbox="272 230 866 689"> <table border="1"> <tr> <td data-bbox="272 230 464 264">LV3</td> <td data-bbox="464 230 663 264">LV2</td> <td data-bbox="663 230 866 264">LV1</td> </tr> <tr> <td data-bbox="272 264 464 454"></td> <td data-bbox="464 264 663 454"></td> <td data-bbox="663 264 866 454"></td> </tr> <tr> <td data-bbox="272 465 464 499">LV0</td> <td data-bbox="464 465 663 499">Error</td> <td></td> </tr> <tr> <td data-bbox="272 499 464 689"></td> <td data-bbox="464 499 663 689"></td> <td></td> </tr> </table> </div>	LV3	LV2	LV1				LV0	Error					<ul style="list-style-type: none"> • Rear PAS (Parking Assist System) (When the gear shift lever is placed in the R (reverse) position with the START/STOP switch in the ON status) <ul style="list-style-type: none"> – When you move the gear shift lever to the R (reverse) position, the warning buzzer sounds briefly once, and when an obstacle near the vehicle is detected, the position and distance from the obstacle are displayed in 4 levels (0-3). – In Level 1 of the rear PAS, the detection result of the front PAS is not displayed, and only the vehicle shape is displayed in Level 0 of the rear PAS. – When the obstacle detection sensor is abnormal, “?” is displayed for the relevant sensor.
	LV3	LV2	LV1											
														
LV0	Error													
														
<p data-bbox="272 712 576 740">If it is in the D (driving) position</p> <div data-bbox="272 757 866 981"> <table border="1"> <tr> <td data-bbox="272 757 464 790">LV3</td> <td data-bbox="464 757 663 790">LV2</td> <td data-bbox="663 757 866 790">Error</td> </tr> <tr> <td data-bbox="272 790 464 981"></td> <td data-bbox="464 790 663 981"></td> <td data-bbox="663 790 866 981"></td> </tr> </table> </div>	LV3	LV2	Error				<ul style="list-style-type: none"> • Front PAS (Parking Assist System) (When the gear shift lever is placed in the D (drive) position with the START/STOP switch in the ON status) <ul style="list-style-type: none"> – When an obstacle is detected in front of the vehicle, the position and distance from the obstacle are displayed in level 3 and level 2, and such position and distance are not displayed in Level 1 and level 0. – The front parking assist system is not activated when the vehicle speed is 15 km/h or higher. ☞ Refer to “Parking assist system*” (p.4-182) – When the obstacle detection sensor is abnormal, “?” is displayed for the relevant sensor. 							
LV3	LV2	Error												
														

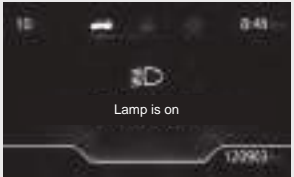

Item	Message	Activation conditions	
Display of door/ engine hood/ tailgate opening	<div style="display: flex; justify-content: space-around;"> <div style="text-align: center;"> <p>Driver door open</p>  </div> <div style="text-align: center;"> <p>Passenger door open</p>  </div> </div>	<ul style="list-style-type: none"> • Displays which door is open. • When the hood or tailgate is open, the corresponding position flashes. • When all doors are closed, the image of a vehicle with all doors closed is displayed for 1 second. 	
	<div style="display: flex; justify-content: space-around;"> <div style="text-align: center;"> <p>Rear left door open</p>  </div> <div style="text-align: center;"> <p>Rear right door open</p>  </div> </div>		
	<div style="display: flex; justify-content: space-around;"> <div style="text-align: center;"> <p>Hood open (flashing)</p>  </div> <div style="text-align: center;"> <p>Tailgate open (flashing)</p>  </div> </div>		
	<p style="text-align: center;">Door warning lamp</p> 		<ul style="list-style-type: none"> • When the door is open, the door ajar warning lamp is displayed on the LCD screen (user setting symbol position). (Main menu symbol changed to door ajar warning lamp)

Item	Message	Activation conditions
Display of tire alignment status	<p>5 levels on the left</p> 	<ul style="list-style-type: none"> • This message is displayed in level 1 to 5 according to the tire alignment status when the START/STOP switch is switched from the OFF status to the ON status. • This message is not displayed when the tire alignment status is level 0. • The message is displayed for 5 seconds up to level 2 and the message is displayed continuously until the condition is met for level 3 to 5. • This message is displayed only when the gear shift lever is in the P (parking) or the N (neutral) position. • For vehicles with the manual transmission, the message is displayed only when the transmission selector lever is in the neutral position and the parking brake is applied.
	<p>0 level</p> 	
	<p>5 levels on the right</p> 	

Item	Message	Activation conditions
Electronic stability control system (ESC) warning	 <p>Check Electronic Stability Control (ESC)</p>	<ul style="list-style-type: none"> If the ESC system is abnormal, the warning light turns on and this message is displayed 3 seconds after the engine is started.
Brake system warning	 <p>Check Electronic Brake force Distribution (EBD)</p>	<ul style="list-style-type: none"> If the EBD system is abnormal, the warning light turns on and the message is displayed 3 seconds later after the engine is started.
ABS warning	 <p>Check Anti-lock Brake System (ABS)</p>	<ul style="list-style-type: none"> If the ABS system is abnormal, the warning light turns on and the message is displayed 3 seconds later after the engine is started.
Engine oil level check	 <p>Check engine oil level</p>	<ul style="list-style-type: none"> If the level of engine oil is insufficient or the engine oil pressure is abnormal, the warning light turns on and this message is displayed 3 seconds later after the engine is started.

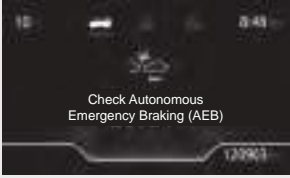
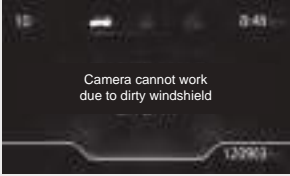

Item	Message	Activation conditions
Exterior lamp ON alert		<ul style="list-style-type: none"> This message is displayed if the exterior lamp is on when the engine is turned off and the driver seat door is opened.
Sunroof open warning		<ul style="list-style-type: none"> A message will be displayed if the sunroof is open after the ignition is turned off.
Refuel warning		<ul style="list-style-type: none"> If the remaining level of fuel is insufficient, the warning light turns on and this message is displayed 3 seconds later after the engine is started.
Low fuel warning (possible to drive up to 30 km)		<ul style="list-style-type: none"> This message is displayed when the distance that can be traveled with current fuel level is approximately 30 km or less.
Smart High Beam (SHB) System Warning		<ul style="list-style-type: none"> In the event of a smart high beam (SHB) system failure, this message will be displayed after 3 seconds of engine start.



Item	Message	Activation conditions
Autonomous Emergency Braking (AEB)		<ul style="list-style-type: none"> • When the operating conditions for the autonomous emergency braking system (AEB) are met, a “Collision Alert” message is displayed for 5 seconds. The AEB warning lamp also flashes for 5 seconds. • If the conditions for displaying warning message are met again during the 5 seconds of the message display, the new warning message will be displayed for 5 seconds with the same flashing of the indicator.
		<ul style="list-style-type: none"> • This message is displayed after the vehicle has stopped by the activation of emergency braking (maximum brake control) by the 3rd warning of AEB.
		<ul style="list-style-type: none"> • If there is a fault in the AEB 3 seconds after the engine start, this warning message is displayed for 5 seconds.
		<ul style="list-style-type: none"> • This message is displayed when the front camera module (FCM) cannot detect the lane markings, preceding vehicles, people, etc. because of the dirt or debris on the windshield glass.



Item	Message	Activation conditions
		<ul style="list-style-type: none"> This message is displayed when the driver untick the box at Driving assistance > Driver attention alert under (User Settings) in the instrument cluster and select main menu (Driving Assistance menu).
Driver Attention Warning (DAW)		<ul style="list-style-type: none"> The driver attention warning (DAW) displays the driver's "cautious driving level" in the 5 bars (5 levels) and if there is no bar at the bottom, the driver will be alerted with a warning message and buzzer. (However, the alarm level will be initialized when the engine is switched off or the driver's seat belt is unfastened and driver's door is open)
		<ul style="list-style-type: none"> This message is displayed in the event of the faulty DAW system. If the message stays on, have the system checked and serviced at a nearest KG Mobility Authorized Service Center.

Driver Attention Warning (DAW)

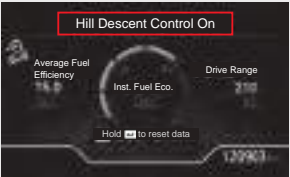
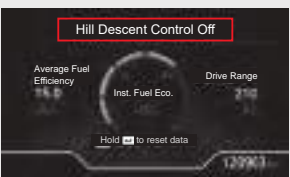
A function that warns and encourages the driver to get some rest by displaying the warning level based on the result of analyzing the vehicle information and the driver's driving pattern.

Item	Message	Activation conditions
Break Time Alert		<ul style="list-style-type: none"> • The message which recommends taking a break is displayed for approximately 10 seconds for your safety after driving for some time. • Alert interval: <ul style="list-style-type: none"> – Only vehicles without DAW will display the message every 2 hours from the time the engine is first started with the ignition switch ON. – For vehicles with DAW, the warning pop-up is displayed by the DAW system.
Refill washer fluid		<ul style="list-style-type: none"> • If the washer fluid level is low, the message asking to replenish washer fluid is displayed. This message is displayed each time the ignition switch is switched from OFF to ON.
Bluetooth photo call standby		<ul style="list-style-type: none"> • When you receive a phone call with the hands-free connected, the caller name or the telephone number is displayed for approximately 5 seconds. If the caller name and the telephone number are incoming at the same time, only the caller name is displayed. • In AV screen (main menu), the pop-up message is not displayed.





Item	Message	Activation conditions
Hill Descent Control (HDC) function ON/OFF		<ul style="list-style-type: none"> • This message is displayed for approximately 5 seconds according to the Hill Descent Control (HDC) ON/OFF status. • The color of the indicator changes according to the HDC operation status. <ul style="list-style-type: none"> – Green indicator turns on: The HDC is in ready status. – Green indicator blinks: The HDC is operating. – Red warning light turns on: The HDC system is overheated and abnormal.
		
HDC System		<ul style="list-style-type: none"> • If the HDC (Hill Descent Control) system is faulty, this message is displayed. • If the message stays on, have the system checked and serviced at a nearest KG Mobility Authorized Service Center.
		<ul style="list-style-type: none"> • If the operating conditions of the HDC system are not met, this message is displayed.

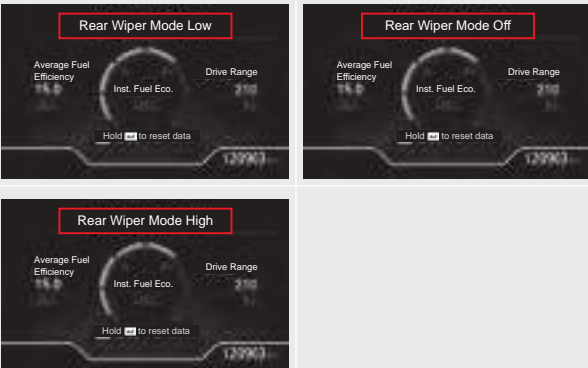

Item	Message	Activation conditions
Cell phone reminder		<ul style="list-style-type: none"> If any phone is on the wireless charging pad after the ignition is off (ignition switch in ACC or OFF position) while the wireless phone charger is operating with the ignition switch in ON position, a reminder message "Cell phone is on the wireless charger" is displayed on the instrument cluster. (However, reminder does not work when changing the ignition switch from the OFF position to ACC position even if the wireless phone charger is operating.)
Driving mode (with A/T)		<ul style="list-style-type: none"> "NORMAL", "SPORT" and "WINTER" are displayed depending on the operation of the driving mode switch touch during driving.

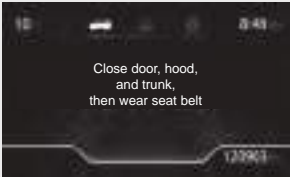
Item	Message	Activation conditions
Steer mode (M/T)		<ul style="list-style-type: none"> • "NORMAL" and "SPORT" are displayed depending on the operation of the driving mode switch touch during driving.



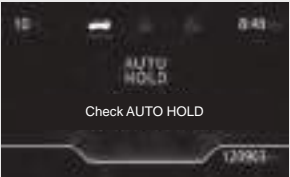
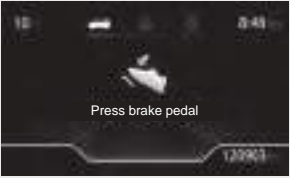

Item	Message	Activation conditions
Steering wheel heater		<ul style="list-style-type: none"> The message is displayed for 5 seconds according to the steering wheel heater ON/OFF status with the START/STOP switch in the ON status or with the engine started.
Light mode		<ul style="list-style-type: none"> The current status among 4 modes is displayed for approximately 5 seconds according to the position of the light switch.

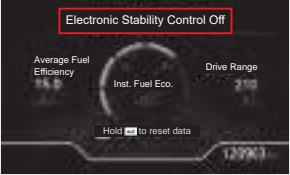
Item	Message	Activation conditions
Windshield wiper mode		<ul style="list-style-type: none"> The current status of the windshield wiper among 4 modes is displayed for approximately 5 seconds according to the position of the wiper operation lever.
Rear window wiper mode		<ul style="list-style-type: none"> The current status of the rear window wiper among 3 modes is displayed for approximately 5 seconds according to the position of the rear window wiper operation lever.

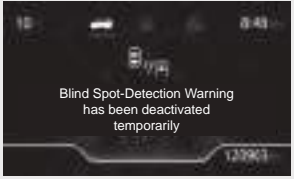

Item	Message	Activation conditions
EPB (Electric Parking Brake)	 <p>Close door, hood, and trunk, then wear seat belt</p>	<ul style="list-style-type: none"> This message is displayed when you press the accelerator pedal with the condition for automatic release not met while the Electronic Parking Brake (EPB) is applied or the AUTO HOLD function is activated.
	 <p>Switching to parking brake</p>	<ul style="list-style-type: none"> This message is displayed when the AUTO HOLD operation status is changed to the Electronic Parking Brake (EPB) status.
	 <p>Activate brake immediately</p>	<ul style="list-style-type: none"> This message is displayed for approximately 5 seconds when the occurrence of vehicle slip or EPB failure is detected with AUTO HOLD activated. However, this message is not displayed if the Electronic Parking Brake (EPB) activated again automatically when a vehicle slip occurs, preventing the occurrence of vehicle slip.
	 <p>Check Electronic Parking Brake (EPB)</p>	<ul style="list-style-type: none"> When the Electronic Parking Brake (EPB) system is abnormal, this message is displayed and the relevant warning light blinks. If the message persists, visit a nearby KG Mobility Authorized Service Center and have your vehicle checked and serviced.

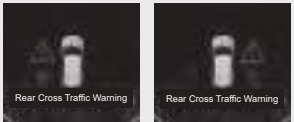
Item	Message	Activation conditions
Auto hold		<ul style="list-style-type: none"> • If the auto hold function is abnormal, the message is displayed. • If the message persists, visit a nearby KG Mobility Authorized Service Center and have your vehicle checked and serviced.
		<ul style="list-style-type: none"> • This message is displayed when you operate the EPB switch without depressing the brake pedal for deactivating the AUTO HOLD function.
Electronic Stability Control (ESC) ON/OFF		<ul style="list-style-type: none"> • This message is displayed for approximately 5 seconds depending on the status of the ESC OFF switch.
		

Item	Message	Activation conditions
Safety Exit Warning (SEW)		<ul style="list-style-type: none"> If you are about to open the door to leave the vehicle when a vehicle is approaching from the rear side, the vehicle exit alert system displays a message and generates a beep sound. However, it operates only when the gear selector lever is in P (park) or N (neutral) position.

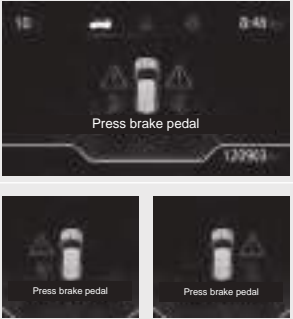
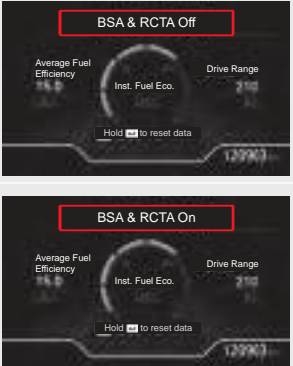

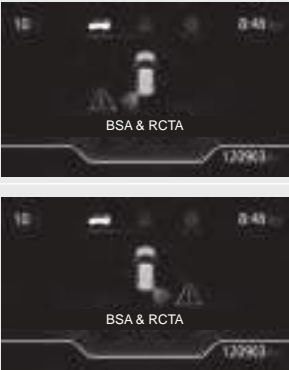

Item	Message	Activation conditions
Blind Spot-Detection Warning (BSW)		<ul style="list-style-type: none"> • This message is displayed in the event of the faulty BSW system. • If the message stays on, have the system checked and serviced at a nearest KG Mobility Authorized Service Center.
		<ul style="list-style-type: none"> • This message is displayed when the BSW system is turned on and the sensor can not normally detect the blind spots: when there are foreign materials on the outside or inside of the rear bumper, a trailer or other equipment is installed in the rear of the vehicle, the width of the road is wide, it snows or rains too much and etc.
Rear Cross Traffic Warning (RCTW)	  	<ul style="list-style-type: none"> • This message is displayed when a vehicle or object is approaching rear left and/or rear right side of the vehicle during the operation of RCTW system.





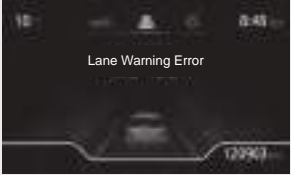

Item	Message	Activation conditions
Rear Cross Traffic Alert Intervention (RCTA)		<ul style="list-style-type: none"> If, the risk of collision is detected due to an approaching vehicle during operation of the RCTA system, emergency braking (braking assistance) is performed while the corresponding alarm is displayed.
Rear cross traffic alert (RCTA)		<ul style="list-style-type: none"> The message will be displayed for about 5 seconds depending on the ON / OFF status of the RCTA system.



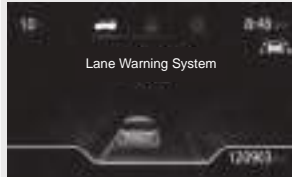

Item	Message	Activation conditions
Blind Spot Collision Assist (BSA)		<ul style="list-style-type: none"> If the risk of collision is detected due to an approaching vehicle during operation of the BSA system, the steering control is carried out while the corresponding alarm is triggered.
Front Vehicle Start Warning (FVSW)		<ul style="list-style-type: none"> This function is enabled when you tick the box at Driving Assist > Front vehicle start warning under  (User Settings) in the instrument cluster. If there is a fault in the FVSW system, this message is displayed. If the message stays on, have the system checked and serviced at a nearest KG Mobility Authorized Service Center.

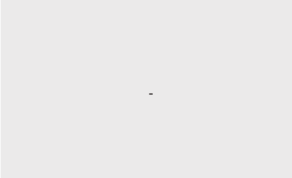



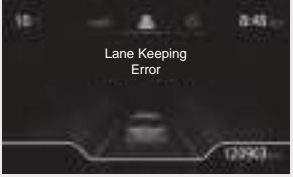

Front Vehicle Start Warning (FVSW)





A function to emit a buzzer and display a message if the driver does not depart the vehicle after the front vehicle has departed and moved a certain distance





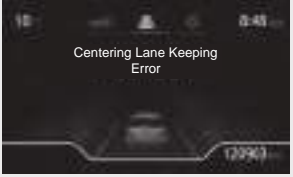

Item	Message	Activation conditions	
Lane Departure Warning (LDW)		-	<ul style="list-style-type: none"> • Displayed when the lane departure warning is disabled.
		-	<ul style="list-style-type: none"> • The lanes are shaded when the vehicle is driven at a low speed of less than 40km/h or at a high speed of 180 km/h or higher or both lanes are not detected.
		-	<ul style="list-style-type: none"> • Displayed when the lane departure warning is disabled.
			<ul style="list-style-type: none"> • This message is always displayed in the event of the faulty LDW. • Displayed as pop-up message 3 seconds after the start-up when there is a fault in the lane departure warning. • If the message stays on, have the system checked and serviced at a nearest KG Mobility Authorized Service Center.

Item	Message	Activation conditions	
LDW Lane Display Area			<ul style="list-style-type: none"> • Even though the left lane is detected only, the detected left lane will be displayed. (Color: blue) • If the driver does not operate the turn signal or turn on the right turn signal and approach the left lane, the lane will blink. (Color: blue ↔ red)
			<ul style="list-style-type: none"> • If only right lane is detected, the detected right lane will be displayed in green. (Color: blue) • If the driver does not operate the turn signal or turn on the left turn signal and approach the left lane, the lane will blink. (Color: blue ↔ red)
			<ul style="list-style-type: none"> • If both lanes are detected, the detected both lanes will be displayed. (Color: blue)
			<ul style="list-style-type: none"> • If both lanes are detected and the vehicle approaches the left or right lane without turning on the turn signal, the lane will blink. (Color: blue ↔ red)



Item	Message	Activation conditions	
LKA (Lane Keeping Assistance)		-	<ul style="list-style-type: none"> • Displayed when the lane keeping assistance system is disabled.
		-	<ul style="list-style-type: none"> • The lanes are shaded when the vehicle is driven at a low speed of less than 40km/h or at a high speed of 180 km/h or higher or both lanes are not detected.
		-	<ul style="list-style-type: none"> • Displayed when the lane keeping assistance system is disabled.
			<ul style="list-style-type: none"> • This message is always displayed in the event of the faulty LKA • Displayed as pop-up message 3 seconds after the start-up when there is a fault in the lane keeping assistance system. • If the message stays on, have the system checked and serviced at a nearest KG Mobility Authorized Service Center.

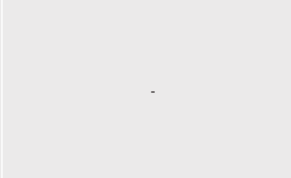

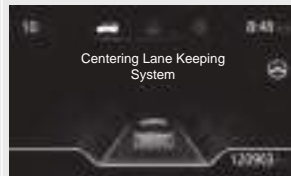
Item	Message	Activation conditions	
LKA lane display area			<ul style="list-style-type: none"> • Even though the left lane is detected only, the detected left lane will be displayed. (Color: blue) • If the driver does not operate the turn signal or turn on the right turn signal and approach the left lane, the lane will blink. (Color: blue ↔ red)
			<ul style="list-style-type: none"> • Even though the right lane is detected only, the detected right lane will be displayed. (Color: blue) • If the driver does not operate the turn signal or turn on the left turn signal and approach the right lane, the lane will blink. (Color: blue ↔ red)
			<ul style="list-style-type: none"> • If both lanes are detected, the detected both lanes will be displayed. (Color: blue)
			<ul style="list-style-type: none"> • If both lanes are detected and the vehicle approaches the left or right lane without turning on the turn signal, the lane will blink. (Color: blue ↔ red)

Item	Message	Activation conditions
Centering Lane Keeping Assist (CLKA)	 <p>Centering Lane Keeping Off</p>	<ul style="list-style-type: none"> Displayed when the centering lane keeping assist (CLKA) is deactivated.
	 <p>Centering Lane Keeping Standby</p>	<ul style="list-style-type: none"> The lanes are shaded when the vehicle is driven at a low speed of less than 1km/h or at a high speed of 180 km/h or higher or both lanes are not detected.
	 <p>Centering Lane Keeping Error</p>	<ul style="list-style-type: none"> Displayed when the centering lane keeping assist (CLKA) cannot be operated.
	 <p>Check Centering Lane Keeping</p>  <p>Check Centering Lane Keeping Assist (CLKA)</p>	<ul style="list-style-type: none"> This message is always displayed in the event of the faulty centering lane keeping assist (CLKA). Displayed as pop-up message 3 seconds after the start-up when there is a fault in the centering lane keeping assist (CLKA). If the message stays on, have the system checked and serviced at a nearest KG Mobility Authorized Service Center.

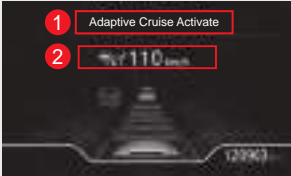

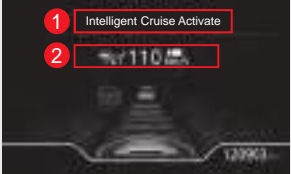

Item	Message	Activation conditions	
Centering lane keeping assist (CLKA) lane display area			<ul style="list-style-type: none"> • Even though the left lane is detected only, the detected left lane will be displayed in blue. • If the driver does not operate the turn signal or turn on the right turn signal and approach the left lane, the corresponding lane will be flashed between blue and red alternately.
			<ul style="list-style-type: none"> • Even though the right lane is detected only, the detected right lane will be displayed in blue. • If the driver does not operate the turn signal or turn on the left turn signal and approach the right lane, the corresponding lane will be flashed between blue and red alternately.
			<ul style="list-style-type: none"> • If both lanes are detected, the detected both lanes will be displayed in blue.
			<ul style="list-style-type: none"> • If both lanes are detected and the vehicle approaches the left or right lane without turning on the turn signal, the corresponding lane will be flashed between blue and red alternately.





Item	Message	Activation conditions
Cruise control (without radar)		<ul style="list-style-type: none"> When you press the cruise control ON/OFF switch with the ignition switch turned on, "Auto cruise ready" message (1) and symbol (2) are displayed and the auto cruise becomes ready.
		<ul style="list-style-type: none"> When you pull down the speed control lever with the auto cruise ready, "Auto cruise set" message (1), symbol and set speed (2) are ready and auto cruise is activated. Adjust the vehicle speed by pushing up or pulling down the speed control lever.
		<ul style="list-style-type: none"> If you disable the cruise control during its operation (ready/auto), "Auto cruise disabled" message is displayed and the cruise control is deactivated.

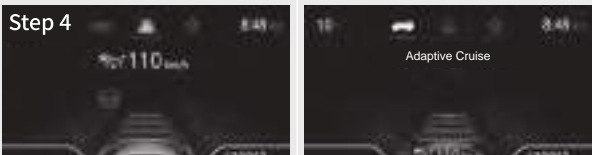



Item	Message	Activation conditions
Adaptive Cruise Control (ACC) (With Radar)		<ul style="list-style-type: none"> When you pull down the speed control lever with the adaptive cruise ready, "Adaptive cruise set" message (1), symbol and set speed (2) are ready and adaptive cruise is activated. If there is no vehicle ahead, the driver's vehicle keeps driving at the set speed. If there is a vehicle driving at a speed lower than the set speed ahead, the driver's vehicle will travel while maintaining a set distance to the vehicle ahead.
		<ul style="list-style-type: none"> During the adaptive cruise control (ACC) operation, when the standby conditions such as the brake pedal are satisfied, the message "Adaptive Cruise Control Ready" (1) and symbol (2) are displayed, and the adaptive cruise control (ACC) enters standby mode. While the adaptive cruise control (ACC) is in standby mode, pushing up the cruise control speed adjustment lever in the RES+ direction activates the adaptive cruise control (ACC).
		<ul style="list-style-type: none"> If you disable the adaptive cruise control during its operation (ready/auto), "Adaptive cruise disabled" message is displayed and the adaptive cruise control is deactivated.



Item	Message	Activation conditions
Intelligent Cruise Control (iACC) (With Radar)	 <p>1 Intelligent Cruise Activate</p> <p>2 110 km/h</p>	<ul style="list-style-type: none"> When you pull down the speed control lever with the intelligent cruise ready, "Intelligent cruise set" message (1), symbol and set speed (2) are displayed and intelligent cruise is activated. If there is no vehicle ahead, the driver's vehicle keeps driving at the set speed. If there is a vehicle driving at a speed lower than the set speed ahead, the driver's vehicle will travel while maintaining a set distance to the vehicle ahead.
	 <p>1 Intelligent Cruise Standby</p> <p>2 110 km/h</p>	<ul style="list-style-type: none"> During the intelligent cruise control (iACC) operation, when the standby conditions such as the brake pedal are satisfied, the message "Intelligent Cruise Control Ready" (1) and symbol (2) are displayed, and the intelligent cruise control (iACC) enters standby mode. While the intelligent cruise control (iACC) is in standby mode, pushing up the cruise control speed adjustment lever in the RES+ direction activates the intelligent cruise control (iACC).
	 <p>Intelligent Cruise Deactivate</p> <p>Lane Warning System</p>	<ul style="list-style-type: none"> If you disable the intelligent cruise control during its operation (ready/auto), "Intelligent cruise disabled" message is displayed and the intelligent cruise control is deactivated.

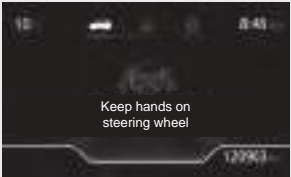

Item	Message	Activation conditions
Intelligent steering assist control		<ul style="list-style-type: none"> • The steering assist symbol is displayed in 3 steps (Ready to set, Set, and Activated) depending on the operating state of the intelligent cruise control. <ul style="list-style-type: none"> – Step 1 (1) : When the intelligent cruise control is in ready mode in the driver assistance main menu – Step 2 (2) : When the intelligent cruise control is set – Step 3 (3) : When driving while maintaining the center of the lane with the intelligent cruise control set
		
		

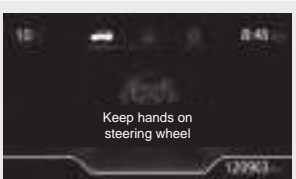
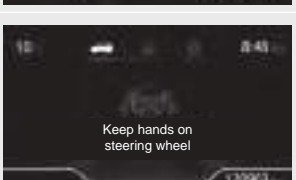

Item	Message	Activation conditions
Intelligent cruise control's distance display (front vehicle not displayed)		<ul style="list-style-type: none"> When you press the safety distance set button with the intelligent cruise control activated, the corresponding message is displayed while the setting is shifted by one step as an order of step 5 → step 4 → step 3 → step 2 → step 1 → step 5.
		
		
		
		



Item	Message	Activation conditions
Intelligent cruise control's distance display (front vehicle displayed)	Step 1 	-
	Step 2 	-
	Step 3 	-
	Step 4 	-
	Step 5 	-
		<ul style="list-style-type: none"> When you press the safety distance set button with the intelligent cruise control activated, the corresponding message is displayed while the setting is shifted by one step as an order of step 5 → step 4 → step 3 → step 2 → step 1 → step 5. At this time, the front vehicle is also displayed on the message.

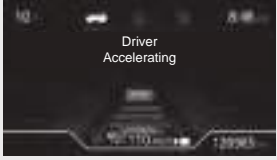

Item	Message	Activation conditions
Lane keeping assistance system hands-off	 <p>Keep hands on steering wheel</p>	<ul style="list-style-type: none"> If the system determines that the driver does not hold the steering wheel with the lane keeping assistance system activated, a message is displayed as the stage 1 warning.
	 <p>Keep hands on steering wheel</p>	<ul style="list-style-type: none"> When a certain period of time has elapsed after the stage 1 warning, the message and beep are given continuously as the stage 2 warning.
	 <p>Keep hands on steering wheel</p>	<ul style="list-style-type: none"> After a period of time since the stage 2 warning message is issued, the message and different beep than 2 stage beep are given as the stage 3 warning.
	 <p>Lane Keeping Assist (LKA) has been deactivated</p>	<ul style="list-style-type: none"> After the stage 3 warning, for safe operation, the LKA is disabled and the relevant message is displayed.

Item	Message	Activation conditions
Intelligent cruise control hands-off	 <p>Keep hands on steering wheel</p>	<ul style="list-style-type: none"> If the system determines that the driver does not hold the steering wheel with the intelligent cruise control system activated, a message is displayed as the stage 1 warning.
	 <p>Keep hands on steering wheel</p>	<ul style="list-style-type: none"> When a certain period of time has elapsed after the stage 1 warning, the message and beep are given as the stage 2 warning.
	 <p>Keep hands on steering wheel</p>	<ul style="list-style-type: none"> After a period of time since the stage 2 warning message is issued, the message and different beep than 2 stage beep are given as the stage 3 warning.
	 <p>Intelligent Adaptive Cruise Control (IACC) has been deactivated</p>	<ul style="list-style-type: none"> After the stage 3 warning, for safe operation, the intelligent cruise control system is disabled and the relevant message is displayed.

Item	Message	Activation conditions
Speed limit		<ul style="list-style-type: none"> When you press the speed limit control ON/OFF switch with the ignition switch turned on, “Speed Limit Standby” message (1) and symbol (2) are displayed and the speed limit becomes ready.
		<ul style="list-style-type: none"> When you pull down the cruise speed selector lever with the speed limit ready, “Speed Limit Activate” message (1), symbol and set speed (2) are displayed and speed limit is activated. Adjust the vehicle speed by pushing up or pulling down the speed control lever.
		<ul style="list-style-type: none"> If you disable the speed limit during its operation (ready / set), “Speed Limit Deactivate” message is displayed and the speed limit control is deactivated.

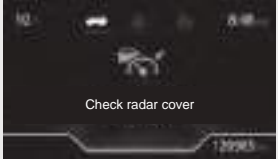
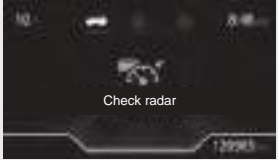
Item	Message	Activation conditions
Adaptive Cruise Control Alert Pop-up	 <p>Forward Collision Warning</p>	<ul style="list-style-type: none"> When the front vehicle is no longer detected for example, due to change of lane, during the adaptive cruise control operation, the message is displayed.
	 <p>When front vehicle departs, operate RES, SET button or pedal</p>	<ul style="list-style-type: none"> If the vehicle stops during the adaptive cruise control operation (or along with ISG), after a certain period of time, you will be prompted to step on the accelerator pedal or raise or lower the cruise control switch to start.
	 <p>Front Vehicle Approach Warning</p>	<ul style="list-style-type: none"> The message is displayed when the distance between the driver's vehicle and the preceding vehicle is getting smaller with the adaptive cruise control activated.
	 <p>Driver Accelerating</p>	<ul style="list-style-type: none"> The message is displayed when the driver depresses the accelerator pedal with the adaptive cruise control activated.

Item	Message	Activation conditions
Adaptive Cruise Control Alert Pop-up	 <p>Adaptive Cruise Control (ACC) has been deactivated</p>	<ul style="list-style-type: none"> The message is displayed when the adaptive cruise control is automatically deactivated.
	 <p>Adaptive Cruise Control (ACC) is not triggered</p>	<ul style="list-style-type: none"> The message is displayed If the operation conditions do not meet during the adaptive cruise control operation.
	 <p>Adaptive Cruise Control (ACC) is deactivated temporarily</p>	<ul style="list-style-type: none"> The message is displayed If the operation conditions do not meet during the adaptive cruise control operation.
Adaptive Cruise Control Check Pop-up	 <p>Check radar cover</p>	<ul style="list-style-type: none"> A message is displayed when the front part of the camera cover is contaminated due to dust, dirt or other materials and can't detect the lane, preceding vehicle or people, etc.
	 <p>Check radar</p>	<ul style="list-style-type: none"> This message is displayed in the event of the faulty radar system. If the message stays on, have the system checked and serviced at a nearest KG Mobility Authorized Service Center.

Item	Message	Activation conditions
Safety distance warning		<ul style="list-style-type: none"> • This function is enabled when you tick the box at Driving assist → Front safety aid → Safety distance warning under  (User Settings) in the instrument cluster. • The message is displayed when your vehicle is approaching the preceding vehicle.
		<ul style="list-style-type: none"> • The message is displayed if the safety distance reminder system is faulty. • If the message stays on, have the system checked and serviced at a nearest KG Mobility Authorized Service Center.

Safety Distance Warning (SDW)

Function to display the message to the driver when it is determined that safety distance is not secured by analyzing the information such as distance to front vehicle, speed and position

To Adjust Instrument Cluster Illumination Brightness

The instrument cluster illumination brightness can be adjusted in 20 steps by lightly touching the instrument cluster illumination control switch (A) with the ignition switch turned on.

At this time, the brightness of the switch light, which is turned on when the tail light is turned on together with the instrument cluster illumination, is also adjusted.



- 1 To make brighter
- 2 To make darker

- A short touch of the instrument cluster illumination control switch will brighten or dim the illumination by one level.
- When you touch and hold the instrument cluster illumination control switch, brightness will lighten or darken by 1 step every about 0.2 seconds.

Notice

- The instrument cluster illumination brightness level is indicated by (A) and (B).
- If the ignition switch is cycled off and on, the instrument cluster illumination remains at the previously set brightness.
- If you keep pressing switch (1), the level will no longer increase above step 20.
- If you keep pressing switch (2), the level will no longer drop in step 1.

Shift lever in manual transmission

The manual transmission in your vehicle has 6 forward gears and 1 reverse gear. To change gears, fully depress the clutch pedal. Then, move the gearshift lever into a desired gear. After shifting, release the clutch slowly.

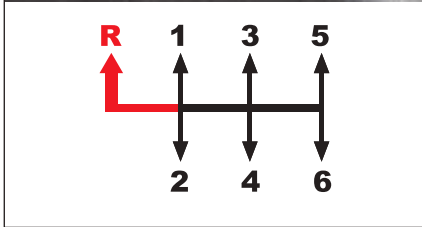
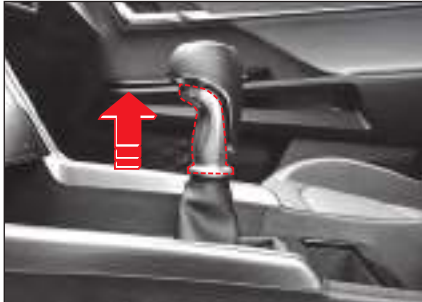

 : Move gear shift lever while pulling reverse shift lever up

 : Move gear shift lever while pulling reverse shift lever up

Reverse Gear

Position for reverse driving.

You should move the gear shift lever while pulling up the lever for reverse shift on the bottom of it.

1st Gear

Position for driving off and high traction force.

Depress the clutch pedal to its travel end and move the shift lever to "1". Then, slowly release the clutch pedal while gently depressing the accelerator pedal to drive off.

3rd Gear

For low- or mid-speed driving.

When upshifting from 2nd gear to 3rd gear, particular caution should be taken not to inadvertently press the gear shift lever sideways in such a manner that 5th gear is engaged.

5th Gear

Position for high speed driving on a highway.

When downshifting from 5th gear to 4th gear, particular caution should be taken not to inadvertently press the gear shift lever sideways in such a manner that 2nd gear is engaged.

6th Gear

Position for very high speed driving on a highway.

4th Gear

Position for normal and high speed driving

2nd Gear

Position for low speed driving

Notice

- Your vehicle is equipped with the gear shift point indicator, which can be shown on LCD display. Refer to Chapter 5. Instrument cluster for details.

Downshifting

When you need to slow down in heavy traffic or while driving up steep hills, downshift the gear to release the load to the engine. Downshifting reduces the chance of stalling and gives better acceleration when you need to increase the vehicle speed again. When the vehicle is driving down steep hills, downshifting provides a safe speed and prolongs the life span of brake system.

Gear position when parking

Always apply the parking brake fully and shut the engine off after parking. Shift the transmission into 1st gear when the vehicle is parked on a level ground or uphill grade, and shift into "R" on a downhill grade.

Using the clutch

The clutch pedal should be depressed all the way to its travel end before shifting. The clutch pedal should be fully released while driving. Do not rest your foot on the clutch pedal while driving. This can cause unnecessary wear in clutch system. Do not operate the clutch pedal rapidly and repeatedly.

Driving tips for normal starting off or starting off on uphill

- 1 Depress the clutch pedal and the brake pedal, start the engine and move the shift lever to the 1st gear (reverse gear in reversing) position.
- 2 If the clutch pedal is released slightly with the brake pedal depressed, the engine rpm increases. (The increase in engine rpm varies depending on the road inclination).

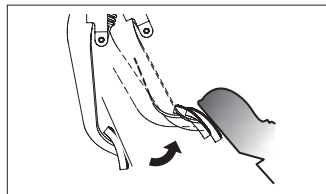

Release the clutch pedal slightly



Increase in engine rpm

- 3 The vehicle starts to move smoothly if you depress the accelerator pedal while releasing the brake pedal after checking that the engine rpm is raising.
- 4 Release the clutch pedal completely after the vehicle starts off.

Notice

- The vehicles equipped with ESP system has HSA (Hill Start Assist) function, which keeps the brake pressure for a certain period of time to prevent the vehicle from slipping on a steep uphill when starting the engine so that you can move your vehicle more safely. HSA system is automatically deactivated after operating for approx. 3 seconds, or the vehicle starts moving with accelerator pedal depressed.
- HSA function does not work when you start the vehicle parked on an uphill in reverse gear, or when you start the vehicle parked on downhill in drive gear.

! Caution

- Because the HSA operation on the brake is automatically cancelled after approx. 3 seconds, you have to release the brake pedal intentionally and depress the accelerator pedal so the vehicle does not slip down the hill.

EPB operation when driving uphill

When driving on a steep uphill, it is safer to use EPB as follows:

Apply EPB and then follow the steps (Vehicle with M/T: steps 1 - 3) EPB will automatically release when the accelerator pedal is pressed while the driver's door, hood and trunk are closed and the seat belt is fastened.



Caution

- To start the engine in manual transmission equipped vehicle, you must fully depress the clutch pedal.
- You should stop your vehicle and fully depress the clutch pedal before you shift into the reverse position.
- If the clutch pedal is frequently half-depressed, the clutch disc will be easily worn out. Use only as needed.
- Do not put your foot on the clutch pedal if not shifting gears.
- When shifting from a higher gear into a lower gear, ensure that the RPM gauge pointer does not go into the red zone on the gauge. Especially, when shifting from the 5th to the 4th gear, moving the gear shift lever to the left too much may result in shifting into the 2nd gear. This will cause a sudden increase of the engine speed and may damage the engine and the transmission.

- When the temperature of the transmission oil is very low on a cold day, you may have some difficulty for shifting gears. This is a normal phenomenon.
- When you have difficulty for shifting into the 1st or reserve gear, put the gear shift lever into the neutral position and release the clutch pedal. Then, depress the pedal again and shift into the intended gear.
- While your vehicle is moving, do not put your hand on the shift lever except to shift gears. Otherwise, the gear may be disengaged from the transmission and the internal transmission components may be damaged.
- Do not shift into the second next higher gear from a lower gear. Also, while the engine is rotating fast, do not shift into a lower gear.
- When using the half clutch mode, there is no need to abruptly depress the accelerator pedal because the engine power increases. When the accelerator pedal is continuously depressed in half clutch mode, the internal components can be worn or damaged. Frequent use of half clutch mode is not recommended.

Gear selector lever in automatic transmission*

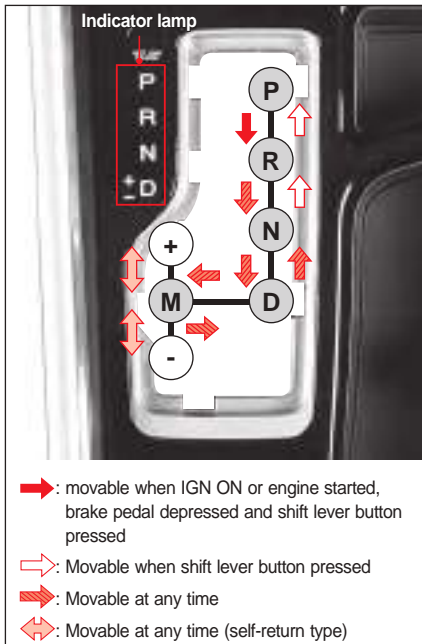

Warning

- When moving the selector lever (shifting), always make sure that the gear position display of the instrument cluster and the left indicator of the selector lever are displayed and lit correctly.

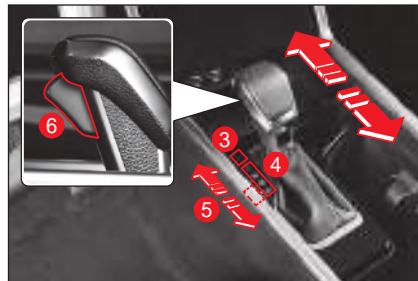

- 1 Paddle shift (-)
- 2 Paddle shift (+)
- 3 P and N position lock release button
- 4 Gear shift lever position (PRND)
- 5 Manual gear control lever (+/-)
- 6 Shift lever button

Paddle shift (-/+)

Shift lever in D (drive) position

- The paddle shift can only be operated while traveling at a speed of 10 km/h or higher.
- Each time you pull the paddle shift + (UP) or - (DOWN), the system enters the manual shift mode by going up or down by 1 step.

If the vehicle speed falls below 10 km/h, move the shift lever from “D” (drive) position to manual mode (+, -) and back to “D” (drive) position while depressing and holding the accelerator pedal for more than 5 seconds. And, the manual shift mode is switched to the automatic shift mode.

- If you move the gear shift lever to the “Manual gear control lever” side, you can use the paddle shift to change the gear position as with the manual transmission.

☞ Refer to “P (parking) position” (p.4-97)

P, N position unlock button

When the gear shift lever is locked in the P (parking) or the N (neutral) position, move the gear shift lever with the Unlock button pressed.

At this time, turn off the engine and move the gear shift lever with the brake pedal depressed.

Gear shift lever position

P: Park / **R:** Reverse / **N:** Neutral / **D:** Drive

When shifting, always make sure that the gear position display of the instrument cluster and the indicator of the selector lever (next to transmission) are lit.

Manual gear shift lever

You can shift the gear by pushing or pulling the manual gear shift lever after moving the gear shift lever from the D (driving) position to the M (manual) position.

Shift Lock

If the driver wants to move the selector lever from the P (park) position to the R (reverse) position, all the following conditions must be met in order to prevent driver's mal-operation and protect the vehicle system:

- Ignition switch and key cylinder ON and engine started
- Brake pedal depressed
- Selector lever button pressed



Caution

- To move the selector lever from the P (park) position to the other positions, make sure that the ignition switch and key cylinder are turned on, the brake pedal is depressed and the selector lever button is pressed.
- If you try to move the selector lever with an excessive force while the selector lever is locked at the P (park) position, it may damage to the selector lever.
- Be sure to follow the operating procedure when releasing the shift lock.

Notice

- When you depress the brake pedal while the selector lever is in the P (park) position, you may hear an operation sound. This is normal sound due to shift lock and lock release operation.

Operation procedures for shift lock



- 1 Depress and hold the brake pedal.



- 2 Turn the ignition switch to the ON position or start the engine.



- 3 While pressing the shift lever button, move the shift lever to other positions.

P (parking) position



Select this position for parking the vehicle, starting or warming up the engine, or stopping the vehicle for a long period of time.

Warning

- Be sure to move the gear shift lever from the P (parking) position to another position while depressing the brake pedal with the START/STOP switch in the ON status. Do not apply excessive force to the gear shift lever when it is fixed to the P (parking) position. Doing so may damage the lever and the transmission.
- Never move the gear shift lever to the P (parking) position while driving. Doing so may cause mechanical damage and an accident. Be sure to move the gear shift lever to the P (parking) position after stopping the vehicle completely.
- Do not use the P (parking) position instead of the parking brake. Apply the parking brake while parking or stopping.

R (reverse) position

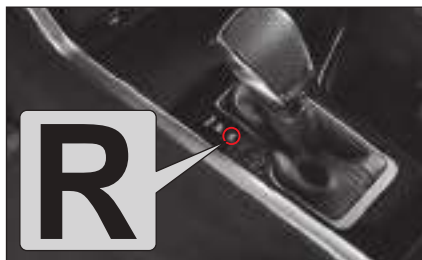

Select this position for reversing the vehicle.

Be sure to move the gear shift lever from the P (parking) or N (neutral) to the R (reverse) position with the brake pedal depressed after stopping the vehicle completely.

When you place the gear shift lever in the R (reverse) position, the PAS is activated.

Warning

- Do not place the gear shift lever in the R position while the vehicle is moving forward. Doing so may cause a transmission shock and damage the transmission.
- If the gear shift lever is placed in the R (reverse) position, the vehicle moves back slowly even if the accelerator pedal is not depressed. Drive carefully by depressing the brake pedal.

N (neutral) position



In this position, no power is transferred.

Since the engine power is not transferred to the wheels in the N (neutral) position, so the vehicle does not move on a flat road. However, if you stop the vehicle with the gear shift lever placed in the N (neutral) position, be sure to depress the brake pedal for safety.



Warning

- Do not apply excessive force to the gear shift lever when it is fixed to the N (neutral) position. Doing so may damage the lever and the transmission.
- Do not move the gear shift lever from the D (driving) position to the N (neutral) position or from the N (neutral) position to the D (driving) position while the vehicle is moving.
- To stop the vehicle with the gear shift lever in the N (neutral) position on a sloping road, be sure to depress the brake pedal.
- Never place the gear shift lever in the N (neutral) position while driving. Doing so may cause the engine brake not to operate, resulting in an accident.

D (driving) position

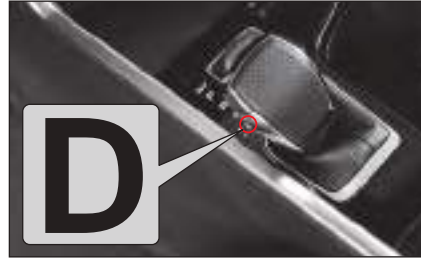

Select this position for driving on a normal road or an expressway.

The gear (1st ~ 6th) is shifted automatically according to the vehicle speed and the depression degree of the accelerator pedal.



Warning

- When the gear shift lever is placed in the D (driving) position, the vehicle moves forward slowly even if the accelerator pedal is not depressed, so drive the vehicle carefully.
- Move the gear shift lever to the D (driving) position after the vehicle has stopped completely. Failure to do so may damage the transmission.
- You can move the gear shift lever from the N (neutral) position to the D (driving) position without depressing the brake pedal. However, move the gear shift lever with the brake pedal depressed for safety.
- Do not drive or accelerate the vehicle suddenly after moving the gear shift lever to the D (driving) position. In particular, when you drive the vehicle after stopping or parking the vehicle on a sloping road, move the gear shift lever to the D (driving) position with the brake pedal depressed, wait for a couple of seconds until the power is transferred in the transmission and drive the vehicle slowly.
- Even if the gear shift lever is placed in the D (driving) position, the vehicle may roll down on a sloping road, so be sure to depress the brake pedal.

+/- (manual) position

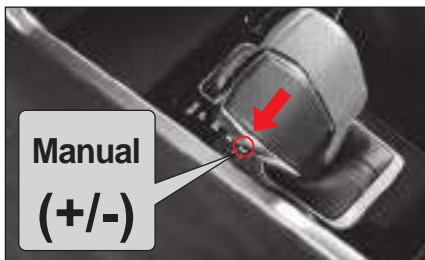

When you move the gear shift lever from D (drive) position to +/- (manual) position, the driver can change the gear position (1st to 6th) manually like the manual transmission.

Warning

- Be careful not to move the gear shift lever inadvertently to the +/- (manual) position while driving. Since the gear position to be shifted is adjusted, this will cause unstable driving situations and can end with an unexpected accident. Especially, be careful when driving in winter.

Caution

- **Upshifting should be carried out properly in accordance with the road and driving conditions. Be careful to keep the engine RPM below the red zone in the tachometer.**

Shifting

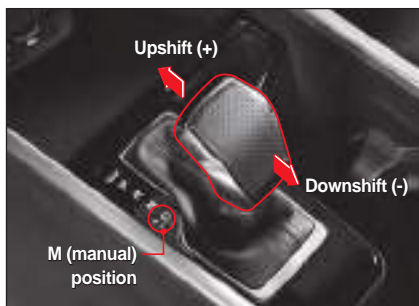

- When the gear shift lever is in +/- (manual) position, the driver can change the gear position by pushing or pulling the shift lever.
- You can shift gear by pulling the paddle shifts fitted to the rear left and right sides of the steering wheel while the paddle shift lever is in the gear shift lever +/- (manual) position.
 - Left (-): Downshift
 - Right (+): Upshift

Notice

- **When you move the gear shift lever to the +/- (manual) position while stopping, you can downshift the gear, and you can start driving the vehicle at the 2nd gear position on a snowy road or a wet road. (WINTER mode function)**
- Sometimes, the gear cannot be shifted when you operate + (upshift) according to the vehicle speed for securing the driving performance. Also, the gear may not be shifted for preventing excessive engine RPM even if you downshift according to the vehicle speed.
- You can adjust the gear position by using the paddle shift switch while the gear shift lever is in D (drive) position but the gear position is changed automatically according to the vehicle condition after a certain period of time.

Display of gear shift lever position on the instrument cluster

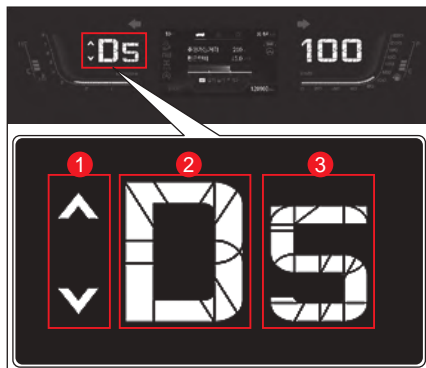

- ① Manual gear-shift point indicator
- ② Shift lever position
- ③ Current gear position

Warning

- Do not downshift (3rd, 2nd, 1st) suddenly while driving the vehicle at a high speed. Doing so may damage the vehicle significantly. The vehicle also may slip, resulting in an accident. (especially when driving on a slippery road)

Caution

- Operate the manual gear shift lever once at a time. If you press and hold down the lever, the gear may be shifted to a number of gear positions consecutively.
- Caution should be taken that if you depress the accelerator pedal fully while driving at the 1st, 2nd, 3rd, 4th, 5th or 6th gear position, the gear may be shifted to a higher gear position.
- If you downshift excessively by operating the manual gear shift lever, the gear may not be shifted for protecting the vehicle system.
- Do not speed up forcibly with the gear shift lever in a lower gear position. Doing so may damage the automatic transmission.

Notice

- The gear shift point indicator lights up while the shift lever is in +/- (manual) position.
- If the gear shift point indicator (①) is displayed during driving with the 3rd gear, it indicates the time to shift to the 4th gear (target) for the best driving.

Using the engine brake

To use the engine brake, downshift the gear by one gear position at a time using the manual gear shift lever from the M (manual) position.



Warning

- **Avoid using the engine brake suddenly.** Doing so may lead to unstable driving. In particular, avoid using the engine brake suddenly while driving on a snowy road or an icy road.



Caution

- **Operate the manual gear shift lever once at a time.** If you press and hold down the lever, the gear may be shifted to a number of gear positions consecutively.
- **When using the engine brake, the gear may be shifted differently depending on the driving condition of the vehicle and you may feel a strong shifting shock.**

If the gear shift lever cannot be moved from the P (parking) position to another position



Although you have operated the gear shift lever according to the shift lock release operation sequence, if it does not move from the P (park) position to the other positions, move it manually as follows:

- 1 Turn off the engine and apply the parking brake.
- 2 Depress the brake pedal and press the shift lock release button with your finger to move it to the N (neutral) position. (Press the knob button when moving the shift lever.)
- 3 In the N (neutral) position, depress the brake pedal and start the engine.
- 4 Move the gear shift lever to the D (driving) position.
- 5 Release the parking brake, take your foot off the brake pedal and drive the vehicle.



Caution

- **If the gear shift lever cannot be moved from the P (parking) position to another position, be sure to have your vehicle serviced at a KG Mobility Authorized Service Center.**

Driving a vehicle equipped with automatic transmission

Place the gear shift lever in the P (parking) position and start the engine with the brake pedal depressed.

- 1 Ensure that the engine RPM is in normal range and place the gear shift lever in the D (driving) or the R (reverse) position with the brake pedal depressed.
- 2 Release the parking brake, take your foot off the brake pedal and drive the vehicle slowly.



Warning

- Do not depress the accelerator pedal when starting the engine. Doing so may make the vehicle move suddenly, causing an accident.
- The engine can also be started after the gear shift lever is placed in the N (neutral) position. However, start the engine after placing it in the P (parking) position for safety.
- Do not drive or accelerate the vehicle suddenly after moving the gear shift lever from the P (parking) position to the D (driving) or the R (reverse) position.
In particular, when you drive the vehicle after stopping on a hillside road, move the gear shift lever to the D (driving) or R (reverse) position with the brake pedal depressed, wait a number of seconds until the power is transferred in the transmission and drive the vehicle slowly.

- Caution should be taken that the vehicle may roll down when it is parked on a sloping road even if the gear shift lever is placed in the D (driving) or the R (reverse) position.
- When moving the gear shift lever while stopping the vehicle, be sure to depress the brake pedal for safety.
- Never depress the accelerator pedal when moving the gear shift lever.
- Be sure to apply the parking brake and depress the brake pedal when stopping on a sloping road.
- On a steep uphill road or downhill road, the vehicle may move in the opposite direction of its moving direction even if the creep phenomenon occurs. Be sure to depress the brake pedal when stopping on an uphill road or a downhill road.
- Do not move the gear shift lever to the N (neutral) position while driving. Doing so may cause the engine brake to not be applied, resulting in an accident. The devices inside the transmission also may not be lubricated smoothly, damaging the transmission.

Notice

- Take your foot off the brake pedal and drive the vehicle slowly by depressing the accelerator pedal after checking that the vehicle moves slowly (creep phenomenon).
- Moving the gear shift lever with the force applied to the driving system of the vehicle due to a slope such as parking or stopping on a hillside road may cause a shock and a noise. This is a mechanical phenomenon that occurs in the P position of the automatic transmission and it is not a system failure.
- In order to maintain the engine in its optimal status, the engine control unit learns and memorizes the inspection characteristics of the injector in accordance with various factors of the engine. Slight vibrations and noises may occur within a short period of time when idling in such a process. This is normal operation of the engine system. Do not misunderstand it as a failure.

What is the creep phenomenon?

The creep phenomenon is the phenomenon that the vehicle moves slowly without the accelerator pedal depressed if the gear shift lever is placed in the D (driver) or the R (reverse) position while the engine is running. You can move the vehicle or adjust the speed by simply operating the brake pedal in heavy traffic or when driving the vehicle slowly in a narrow area.

What is automatic shift point?

The automatic shift point of the automatic transmission may vary depending on various driving elements including the road condition (flat ground, hillside road), position of gear shift lever, vehicle speed and depression degree of accelerator pedal. This is a normal operation for securing smooth and stable shifting, proper economy and vehicle performance.

Using the engine brake

When driving a long downhill road, use the engine brake and the foot brake at the same time. When you downshift according to the driving condition, the engine brake will operate.

What is the engine brake?

The engine brake is the decelerating force that occurs due to the deceleration of the engine when you take your foot off from the accelerator pedal while driving. Down shifting while driving a downhill road can receive the braking effect without using the foot brake frequently due to the decelerating force that occurs in the engine. The lower the gear, the higher the engine brake effect.



Warning

- **Do not use the foot brake excessively on a downhill road. Doing so may cause the fade or vapor lock phenomenon due to overheating of the brake system, lowering the braking performance.**
- **The engine brake does not operate when the gear shift lever is placed in the N (neutral) position.**
- **Do not apply the engine brake suddenly. Doing so may cause the tires to slip, resulting in an accident.**

Using the kick down function

You can use the kick down function by depressing the accelerator pedal to the end when you need instantaneous accelerating force for passing a vehicle.

What is the kick down function?

The kick down function downshifts the gear by one or two lower gear positions when the accelerator pedal is depressed to the end while driving. It can be used when instantaneous accelerating force is necessary.



Warning

- Do not use the kick down function on a slippery road or a sharply curved road. If the tires slip, an unexpected accident may occur.
- Using the kick down function excessively may adversely affect the durability and fuel economy of the vehicle.

Safety mode of the automatic transmission

When an electrical or mechanical defect occurs in the automatic transmission, the automatic transmission enters the safety mode in order to prevent the transmission from being damaged while maintaining the minimum driving status.

When the automatic transmission enters the safety mode, any of the following symptoms may occur.

- A significant shock occurs when moving the gear shift lever.
- The driving force is reduced while driving the vehicle at a high speed.
- When the gear shift lever is fixed to the driving position (D, R) and the vehicle speed does not increase even if the accelerator pedal is depressed (the speed is fixed to the medium speed).



Caution

- If the safety mode symptom appears due to an electrical or a mechanical defect of the automatic transmission, do not drive the vehicle and have your vehicle checked and serviced at a nearby KG Mobility Authorized Service Center.

Resetting the safety mode when the gear shift lever is fixed to a position

Resetting the safety mode

- 1 Stop the vehicle and place the gear shift lever in the P (parking) position.
- 2 Turn off the engine and wait for 10 seconds or longer.
- 3 Start the engine.

After resetting the safety mode, you can drive the vehicle normally.

If the fixed gear shift lever phenomenon appears after resetting the safety mode

The following fixed gear shift lever symptom appear after resetting the safety mode.

- The gear shift lever is fixed to the D (driving) position (forward 2nd gear position)
- The gear shift lever is fixed to the R (reverse) position (reverse 2nd gear position)

In such case, have your vehicle checked and serviced at a nearby KG Mobility Authorized Service Center.



Caution

- If the safety mode symptom persists after resetting the safety mode, do not drive the vehicle forcibly and have your vehicle checked and serviced at a KG Mobility Authorized Service Center immediately.

Cautions for using a vehicle equipped with automatic transmission



Warning

- Never move the gear shift lever to the P (parking) or the N (neutral) position while driving. Doing so may cause mechanical damage and an accident.
- Starting the vehicle is available when the gear shift lever is placed in the P (parking) or the N (neutral) position. Start the engine with the gear shift lever in the P (parking) position for safety.
- Do not down shift suddenly while driving the vehicle at a high speed. Doing so may damage the vehicle significantly. Doing so also may lead to unstable driving and result in an accident.



Caution

- Do not place the gear shift lever in the R position while the vehicle is moving forward. Doing so may cause a transmission shock and damage the transmission.
- Do not place the gear shift lever in the N (neutral) position when driving on a downhill road or an uphill road. Placing the gear shift lever back in the D (driving) position for driving after placing it in the N (neutral) position may damage the driving system due to a transmission shock.
- The P lock (P position → R position) and the R lock (N position → R position) functions that allow the operation of the gear shift lever only when the brake pedal is depressed for safe driving.
- When you unlock the gear shift with the brake pedal depressed by the P lock and the R lock functions, there may be a normal operating sound of locking and unlocking the gear shift lever.
- When you move the gear shift lever related to the R lock function from the D (driving) position to the P (parking) position rapidly, there may be intermittent trapping in the N (neutral) position. This is a normal phenomenon for safety and the protection of the transmission. However, avoid sudden operation if possible.

What is Electric AWD (All Wheel Drive)?

The electric AWD (All Wheel Drive) is usually operating in 2WD mode.

If the vehicle determines that 4WD is needed because of the differences in slip and cornering between front and rear wheels, road gradient and etc., it is switched to 4WD automatically by the computerized control unit.

This equipment improves the straight-line stability and turning performance of the vehicle and secure the drivability in dangerous situations such as rainy road, snowy road and sandy path, etc., so that the vehicle can maintain stable driving state compared with the 2WD mode.

In some cases, the 4WD LOW mode known as 4WD LOCK can be used to maximize driving force.

What is 4WD?

4WD stands for Four Wheel Drive and drives all the wheels to maximize the vehicle's driving force on the unpaved road, rough road, steep hills, sandy or muddy road for enhanced driving performance.

4WD LOCK Shift

Lightly touch the switch AWD LOCK (4WD LOCK shift) (A). The vehicle will enter 4WD LOCK mode.

- ON: 4WD LOCK indicator lit on instrument cluster / switch shows white symbol
- OFF: 4WD LOCK indicator turned off on instrument cluster / switch shows gray symbol

When the speed of the rear wheel exceeds 40 km/h in 4WD LOCK mode, 4WD LOCK mode is canceled and system returns to 4WD AUTO mode. However, the 4WD LOCK indicator remains turned on / switch remains show white symbol and system will return to 4WD LOCK mode if the speed falls below 40 km/h.

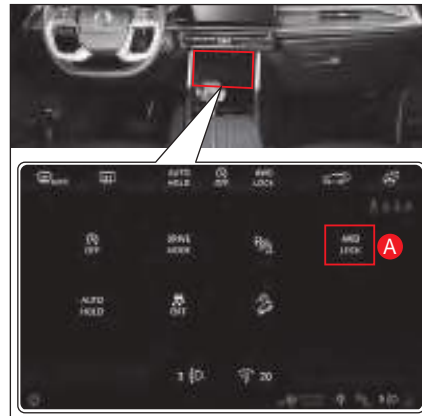

Driving Modes and Indicators

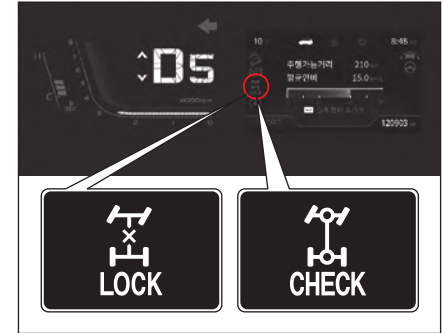

4WD LOCK indicator (green)

When the vehicle enters 4WD LOCK mode, the 4WD LOCK indicator on the instrument cluster lights up. (The switch shows the white symbol.)

4WD CHECK warning lamp (red)

This warning lamp comes on when the 4WD system is faulty. If the warning lamp is turned on, have the vehicle checked and serviced at a KG Mobility Dealer or KG Mobility Authorized Service Center. Excessive use of the 4WD system may cause the warning lamp to blink. At this time, the 4WD system will not operate normally, but driving is possible. After a certain period of time, the warning lamp will turn off and the 4WD system may return to normal function.

Driving Modes

4WD AUTO

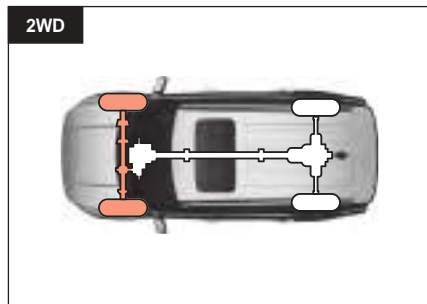

Normal driving condition.

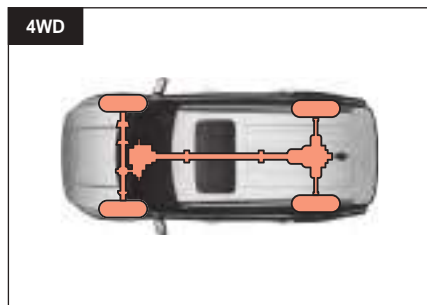

When the system determines that greater driving force and driving stability is needed, it is switched to 4WD automatically by the computerized control unit.

4WD LOCK

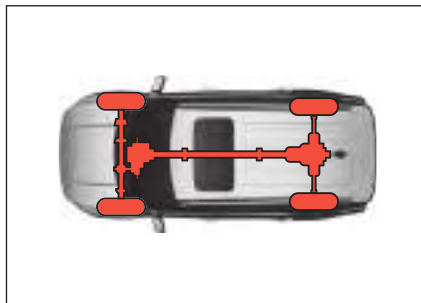

Use in situations where maximum driving force is required such as unpaved road, rough road, steep hills, sandy or muddy road.

Cautions for using 4WD system

Caution

- Always start the engine prior to operating the 4WD LOCK dial to use 4WD LOCK mode.
- Always use 4WD AUTO mode when driving on a public road. Driving on a public road in 4WD LOCK mode (especially when cornering) may damage 4WD system relevant components and may cause noise and vibration to the vehicle.
- When you drive the vehicle on a public road in 4WD LOCK mode (especially when cornering at low speed), slight noise and vibration may occur. This is extremely normal and disappears when 4WD LOCK mode is deactivated .
- In addition, a slight shock may occur when 4WD LOCK mode is deactivated on an incline. This is a normal phenomenon that occurs when the driving force that was simultaneously acting on the front and rear wheels is released.
- If the 4WD CHECK warning lamp  lights up, 4WD will be disabled. Have the vehicle checked and repaired immediately by a KG Mobility Dealer or KG Mobility Authorized Service Center.



Caution

- For the vehicles with the constant 4WD system, do not allow the vehicle to be towed with the tire on the ground. To prevent damage to the driving-related parts, always lift the towed vehicle wheels on the tow truck or place the dolly under the rear wheel when towing.
 - ☞ Refer to “When you need to have your vehicle towed” (p.5-21)
- In 4WD mode, the vehicle performance depends greatly on the tire condition.
 - Check tire wear and tire pressure on a regular basis.
 - For vehicles with 4WD system, to prevent damage to the drive system, the tires with same size from the same manufacturer should be used for all 4 wheels. When replacing the tire and wheels, replace all four wheels at the same time.

ISG (Idle Stop & Go) System*

The ISG (Idle Stop & Go) system stops the engine when the vehicle is stationary and restarts the engine when driving resumes to improve fuel economy and reduce exhaust emissions.



1 ISG ON indicator

2 ISG OFF switch



Caution

- Some warning lamps may light up momentarily when the engine is started by the ISG system. This is a normal phenomenon due to momentary current consumption.

Engine Automatic Shutdown

If the vehicle speed is 0 km/h (stationary) and the brake pedal is depressed while the ISG system is operating, the engine will automatically stop.

At this time, a message is displayed on the instrument cluster LCD showing the accumulated time of engine shutdown.



Notice

- The automatic shutdown of the engine by ISG system is maintained for up to 3minutes, and the engine restarts automatically after 3 minutes.

Automatic Engine Restart

When the engine is automatically stopped, releasing the brake pedal automatically restarts the engine. At this time, the instrument cluster LCD displays a message indicating that the engine has been restarted.



Notice

Engine restarts automatically when:

- Releasing brake pedal (AUTO HOLD disabled for vehicles with EPB)
- Moving shift lever to R or +/- (for manual) position while depressing brake pedal
- Applying EPB

ISG system OFF

- 1 When you touch the ISG OFF switch (1) lightly, the ISG function stops and the ISG OFF indicator (2) lights up.
- 2 Lightly touching the ISG OFF switch again resumes normal operation of the ISG system and turns off the ISG OFF indicator on the instrument cluster.



Conditions for ISG system activation

- Driver's seat belt fastened
- Driver's door closed
- Engine hood closed
- With no accelerator pedal depressed
- Idling speed of 1,350 rpm or less
- Coolant temperature between 35°C and 105°C
- Appropriate level of brake negative pressure
- Battery sensor active and meets ISG condition
- Steering wheel 180° or less when stationary
- No certain signal to heater and A/C controller
- Gentle road slope
- Battery temperature between -5°C and 60°C
- Ambient temperature -2°C or higher
- Vehicle stops after moving at least 1 m
- Vehicle stops after reaching vehicle speed over 9 km/h
- No faulty ISG system-related parts
- Shift lever in D (drive) or N (neutral) position

Forced restart conditions

- Press ISG OFF touch switch to stop ISG system
- Engine coolant temperature higher than 110°C
- Heater and A/C controller operating at maximum level
- Defroster in operation
- Poor battery charge level
- Vehicle speed over 2 km/h
- Engine automatic shutdown maximum time (3 min) elapsed
- Faulty components of ISG system and start system
- Release brake pedal and depress accelerator pedal slightly during AUTO HOLD execution
- Driver seat belt unfastened or driver's door open
- Steering wheel angle 180° or greater or steering wheel turned 180 deg/s or higher
- A/C in operation
- Changes in vehicle interior and exterior temperatures within a short period of time
- EPB applied

Battery sensor (BSC)

The battery sensor (BSC) is fitted to the battery negative (-) terminal and monitors the battery information (such as voltage, current, temperature and charge status) and communicates with the EMS to operate the ISG (Idle Stop & Go) system.

When you disconnect the battery sensor connector to repair the vehicle or remove and refit the battery negative (-) terminal, the battery sensor will be deactivated and ISG system may have limited functionality.

If the battery sensor is deactivated, refer to the activation conditions to activate it prior to using the ISG system.

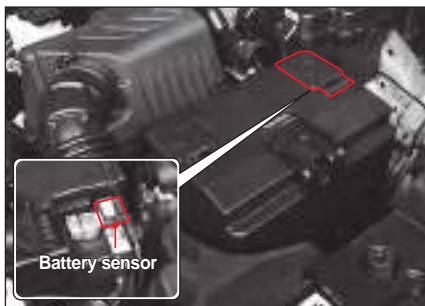

Conditions for activating battery sensor (BSC)

While the electrical equipment in the same condition as factory shipment is connected after re-installing the battery with the ignition switch off, if the vehicle monitors the battery voltage for more than about 3 hours and judges it to be stabilized, the battery sensor will be activated.

Caution

- **If the ISG system does not work after the battery sensor activation conditions are met, have the system checked and serviced at the nearest KG Mobility Authorized Service Center.**

Warning

- **When replacing the battery, always replace with the our genuine ISG system battery (AGM). Otherwise, it may result in serious system failures, battery damage, and explosion due to overcharging, etc.**

Cruise control system

The cruise control system is an auxiliary convenience system that allows the driver to drive the vehicle at a set speed without depressing the accelerator pedal with the flow of traffic where more than a legal safe distance is secured.

The cruise control system is not a safe driving system. Be sure to always drive the vehicle while paying attention to the vehicle speed and surrounding situations.

The cruise control system can be activated when the vehicle is driven at a speed of approximately 40 km/h or greater and less than 180 km/h.

Conditions for using the cruise control

Be sure to use the cruise control only under the following traffic and road conditions.

- Use the cruise control when the current traffic condition is light.
- Use it only on a driveway or an expressway where no change in the vehicle driving condition due to traffic lights, vehicles, pedestrians or other factors is expected.
- Do not use it on a normal road.

Warning

- Use the cruise control system only on a motorway or an expressway where the road is in good condition.
- Stop using the cruise control system in the following road conditions since control may become impossible, causing an accident.
 - When a strong wind or a side wind blows
 - When there is traffic congestion
 - Slippery road, sloping road or continuously curved road

Cruise control switch and indicator

Cruise control switch

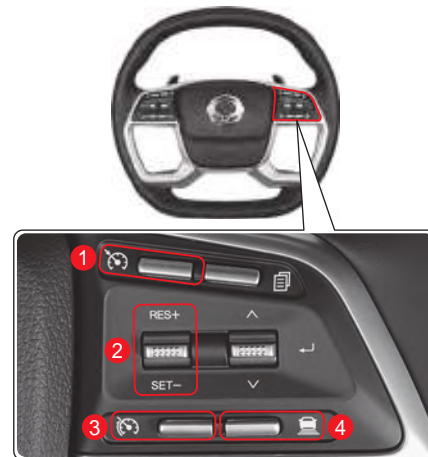

1 Cruise control ON/OFF switch

2 Speed selector lever

RES+

- Reactivating cruise control
- Increasing speed

SET-

- Set driving speed on cruise control
- Decreasing speed

3 Speed limit ON/OFF switch

4 Button for setting safe distance

Cruise Control Ready / Enabled Display

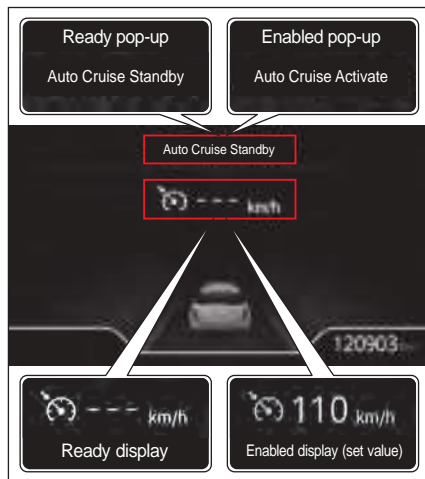

Auto cruise READY

The following message is displayed on the instrument panel LCD screen and the system enters auto cruise READY mode when you press the cruise control ON/OFF switch.

- "Auto cruise READY" pop-up displayed
- Symbol and "--- km/h" indicating that system ready to display speed displayed

Auto cruise ENABLED

When the cruise control is in the Ready mode and the speed control lever is lowered, the following message is displayed on the instrument panel LCD screen and the cruise control is enabled.

- "Set Auto Cruise" pop-up displayed
- Symbol and set speed, "100km/h" displayed

The cruise control works when driving at a vehicle speed of about 40 km/h or higher.

Setting the cruise control driving speed

- 1 Press the cruise control ON/OFF switch.
The instrument cluster shows "Auto cruise is ready".
- 2 Adjust the vehicle speed so that the speed range for the cruise control operation is between approximately 40 km/h and 190 km/h.
- 3 Set the desired driving speed by raising or lowering the speed control lever of the cruise control in the SET- direction.
Now, the vehicle is driven at the set speed without depressing the accelerator pedal.

4



Warning

- Activate or deactivate the function after fully familiarizing yourself with the cruise control system. The cruise control operation speed should be set while driving. Operating it improperly or without fully familiarizing yourself with the system may lead to an accident.
- When you activate the cruise control while driving, do not change the gear shift lever to the N (neutral) position. Doing so may damage the relevant system or cause an accident.
- When you drive the vehicle at a fixed speed with the cruise control system activated, be sure to drive safely in order to be able to deal with any situation that can occur on the road and drive the vehicle in a way that you can operate the brake pedal and the accelerator pedal immediately.
- Be sure to always secure safe braking distance, depress the brake pedal if necessary.
- The actual speed for driving up or down a hillside road may be slightly different from the set speed. Avoid using the cruise control system on a hillside road or a sloping road if possible.
Use the engine brake and the foot brake on a steeply sloping road for driving safely and protecting the vehicle system.

Caution

- When not using the cruise control, press the cruise control ON/OFF switch to turn off the auto cruise READY indicator.

Notice

- To reset the cruise control operation speed, carry out Step No. 2 and No. 3 again with the cruise control activated.
- If the tires of your vehicle are replaced with tires with different size at your disposal, it may cause an error in the set speed. In this case, please contact our service center.
- Refer to the following contents for the detailed operation for each vehicle operation condition.

Speed acceleration process of the cruise control

When the cruise control system is activated

To increase the set vehicle speed while driving with the cruise control activated, push the speed control lever up in the RES+ direction with the accelerator pedal not depressed.



- Pushing the speed control lever up briefly once increases the speed by 1 km/h.
- If you push up the speed control lever for a long time, the speed increases by 1 km/h. The vehicle setting speed increases continuously while the lever is being raised.

When the cruise control system is not activated

The following steps describe how to activate the cruise control system when it is not activated and raise the set vehicle speed.

- 1 Press the cruise control ON/OFF switch.
The instrument cluster shows "Auto cruise is ready".
- 2 Depress the accelerator pedal until the vehicle speed becomes approximately 40km/h or higher in order to activate the cruise control.
- 3 When the desired set speed is reached, adjust the speed by pressing the speed control lever in the SET- direction.
While you are pushing up the speed control lever toward RES+, the vehicle setting speed increases by 1km/h.
- 4 After setting the speed, take your foot off from the accelerator pedal slowly.

Increasing the set speed by phases with the cruise control activated

To increase the speed cruise control slightly by phases with the cruise control activated, carry out the following steps.

- Push the speed control lever up briefly in the RES+ direction (within 0.5 second). The set vehicle speed increases by approximately 1 km/h each time you push the speed control lever up.
- For example, if you wish to increase the set vehicle speed by approximately 10 km/h, push the speed control lever up briefly in the RES+ direction 10 times.
- Push up and hold the speed control lever toward RES+ for more than 0.8 seconds. The vehicle setting speed increases by 1 km/h every about 0.8 second while you're pushing up the lever.

Speed deceleration of the cruise control

When the cruise control system is activated

To decrease the set vehicle speed with the cruise control activated, push the speed control lever down in the SET- direction with the brake pedal not depressed.



- The set vehicle speed decreases by 1 km/h each time you push the speed control lever down briefly.
- Pushing and holding the speed control lever down continuously decreases the set vehicle speed continuously.
However, when the vehicle speed becomes approximately 40 km/h or less, the cruise control function is deactivated.

Decreasing the set speed by phases with the cruise control activated

To decrease the speed cruise control slightly by phases with the cruise control activated, carry out the following steps.

- Push the speed control lever down in the SET- direction briefly (within 0.5 second). The set vehicle speed decreases by approximately 1 km/h each time you push the speed control lever down.
- For example, if you wish to decrease the set vehicle speed by approximately 10 km/h, push the speed control lever down briefly in the SET- direction 10 times.
- Lower and hold the speed control lever toward SET- for more than 0.8 seconds. The vehicle setting speed decreases by 1 km/h every about 0.8 second while you're lowering the lever.

Deactivating the cruise control

When the following deactivation signal is detected with the cruise control activated, the cruise control system is deactivated (auto cruise is ready).

Deactivation condition

- When the brake pedal is depressed for braking
- When the cruise control ON/OFF switch is operated once (cancel the operation when the switch is operated twice)
- When the gear shift lever is shifted to the N (neutral) position while driving

Other deactivation conditions according to the vehicle condition

- When the Electronic stability control system (ESC) is activated
- When the decelerated speed of the vehicle is approximately 40km/h or less
- When the parking brake is depressed while driving
- Clutch pedal is depressed to shift (M/T only).
- When the cruise control switch is abnormal
- When an abnormal signal from the brake system is detected
- When the engine RPM is approximately 5,700 rpm or higher
- When road shock is severe

If normal conditions for the deactivation of cruise control are not met or an intermittent malfunctions occur, turn off the engine, wait for a little bit and start the engine again. The system is resets so that you can activate the system normally.

Resuming the cruise control

When the cruise control is deactivated due to a cruise control disabled signal (auto cruise ready), the cruise control can be reactivated.

Push up the speed control lever toward RES+ briefly at a vehicle speed of about 40 km/h or higher without depressing the brake pedal.



- The last set speed memorized before the cruise control was deactivated is resumed.
- The AUTO CRUISE indicator on the instrument cluster turns on.

Intelligent / Adaptive Cruise Control*

Intelligent cruise control system

This system keeps the vehicle speed constant even if the driver does not depress the accelerator pedal and brake pedal. When a preceding vehicle is detected, it keeps the distance to the preceding vehicle constant at the preset distance. It allows the vehicle to travel in the middle of the lane via steering wheel (steering force) control.

Adaptive cruise control system

This is a convenient device to keep the vehicle speed constant even if the driver does not depress the accelerator pedal and brake pedal. When a preceding vehicle is detected, it keeps the distance to the preceding vehicle constant at the preset distance.

Intelligent Cruise Control Ready / Enabled Display

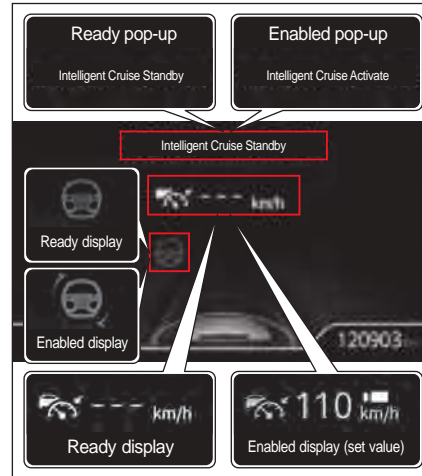

Set intelligent cruise (enabled)

When the intelligent cruise control is in the Ready mode and the speed control lever is lowered, the following message is displayed on the instrument panel LCD screen and the intelligent cruise control is enabled.

- “Intelligent cruise set” pop-up displayed
- Symbol and set speed displayed

The adaptive cruise control works when driving at a vehicle speed of about 10km/h or higher.

Notice

- **The description in this section is based on the intelligent cruise control. Steering wheel (steering force) control does not work when the adaptive cruise control system is operating.**

Intelligent Cruise Control Ready

The following message is displayed on the instrument panel LCD screen and the system enters intelligent auto cruise READY mode when you press the cruise control ON/OFF switch.

- “Intelligent cruise READY” pop-up displayed
- Symbol and “--- km/h” indicating that system ready to display speed displayed

To enable intelligent cruise control at instrument cluster

- Go to **Driving Assist Setting** → **Intelligent Adaptive Cruise Control** under  (User Settings) in the instrument cluster and tick the box.

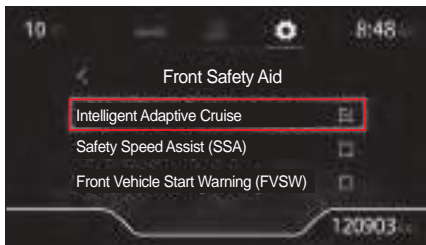

To set intelligent cruise control

- 1 Press the cruise control ON/OFF switch. “Intelligent cruise control READY” message is displayed on the instrument cluster.
- 2 Adjust the vehicle speed within the operating speed range of the intelligent cruise control.
 - Set speed (30 km/h ~ 180 km/h)
 - Operating speed (0 km/h ~ 180 km/h)
- 3 Lower the cruise speed selector lever toward SET- or raise toward RES+ to enable the cruise control.
 - “Intelligent cruise control set” message is displayed on the instrument cluster.
 - Then, the vehicle maintains the set speed without depressing the accelerator pedal and keeps driving in the middle of the lane via steering wheel (steering force) control.
 - If a preceding vehicle is detected, the driver’s vehicle will travel while maintaining a set distance to the vehicle ahead.



Caution

- The vehicle speed may decrease or increase temporarily on uphill or downhill while the intelligent cruise control is operating.

4

Increasing speed

To increase the set speed during intelligent cruise control operation, push the speed selector lever up toward RES+ without depressing the accelerator pedal.



- Each time you push up the speed selector lever briefly, the speed increases by 1 km/h.
- If you push up the speed control lever for a long time, the speed increases by 10km/h. The vehicle setting speed increases continuously while the lever is being raised. (The set speed increases by a factor of 10.)
- You can set up to 180 km/h.

Caution

- **Since if you push up and hold the lever the vehicle speed increases quickly, be careful of the surrounding situation when operating.**

Decreasing speed

To decrease the set speed during intelligent cruise control operation, push the speed selector lever down toward SET- without depressing the accelerator pedal.



- Each time you push down the speed selector lever briefly, the speed decreases by 1 km/h.
- If you push down and hold the speed selector lever, the speed decreases by 10 km/h. The set speed decreases continuously while the lever is being lowered. (The set speed decreases by a factor of 10.)
- The lowest settable speed is 30 km/h.

Temporary acceleration (override)

Depress the accelerator pedal to accelerate the vehicle temporarily while intelligent cruise control is in operation.

Temporary acceleration is possible by driver's will without affecting the set speed.

In order to return the set speed, release the accelerator pedal. The vehicle will travel at the set speed.

Caution

- **If you depress the accelerator pedal for more than about 60 seconds for temporary acceleration, the intelligent cruise control system will stop operating.**

Deactivating

If any of the following conditions is met while intelligent cruise control is operating, it will be disabled. (intelligent cruise control ready mode)

Disable conditions

- Brake pedal depressed for braking
- Cruise control ON/OFF switch pressed once (pressing twice deactivates system)
- Depressing accelerator pedal for more than 60 sec (override)
- Electric vehicle posture stability control system in operation (e.g., ESC, TCS and ABS)
- Electric vehicle posture stability control system OFF (by ESC OFF switch)
- Shift lever in positions other than D (drive)
- EPB applied
- Driver's door open
- Maximum adaptive cruise control speed (180 km/h) exceeded
- Engine speed below 350 rpm or above 7,000 rpm

- 3rd warning, emergency braking applied by AEB
- HDC system in operation
- Heavily contaminated radar sensor cover

Other disable conditions

- No preceding vehicle at the time of restart after vehicle stop by control
- Distance to front vehicle too far or too close during vehicle stop control
- Vehicle stop control occurs frequently

Notice

- If "Intelligent cruise control READY" message is displayed on the instrument cluster with the disable conditions met, when you push up the speed selector lever toward RES+ briefly, the intelligent cruise control is reactivated.
- To restart the vehicle in which ISG and AUTO HOLD are operating at the same time, you should depress the accelerator pedal.

If the intelligent cruise control is disabled, check the road situations and driving conditions. In addition, depress the brake pedal to adjust the vehicle speed properly.

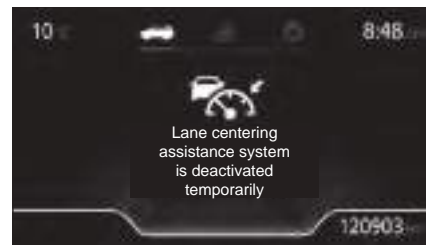

Notice

- The message is displayed if the intelligent cruise control is disabled abnormally.

Resume

If the intelligent cruise control is disabled (intelligent cruise control ready), you may reactivate it.

Push up the speed control lever toward RES+ briefly at a vehicle speed of about 10km/h or higher without depressing the brake pedal or accelerator pedal.



- The set speed returns to the value before intelligent cruise control was disabled.

Caution

- **When resuming, the vehicle speed can be increased or decreased quickly to the set speed just before it is disabled. Be aware of the surrounding road conditions before resuming.**

If the following message is displayed on the instrument cluster while the vehicle is stationary, push up or lower the speed selector lever briefly toward RES+ or SET-.

Then, the intelligent cruise control resumes.

Depressing the accelerator pedal also resumes the intelligent cruise control.



To Deactivate

In order to deactivate the intelligent cruise control completely, press the cruise control ON/OFF switch twice or press the speed limit switch.

- Intelligent cruise pop-up disappears on the instrument cluster.

When not using the intelligent cruise control, always press the switch to deactivate it.

Caution

- **If you depress the accelerator pedal for more than about 60 seconds for temporary acceleration, the intelligent cruise control system will stop operating.**



Warning

- When not using the intelligent cruise control, always turn off the system.
- Always set the speed of the intelligent cruise control within the speed range specified by law.
- Check the surrounding road conditions prior to using the intelligent cruise control.
- Do not use the intelligent cruise control under following circumstances:
 - Near high interchange and tollgate
 - Where there are a lot of metals around road such as construction site and iron tunnel
 - Where lanes and guard rails in close proximity
 - Where there is no lane such as parking lot
 - Uphill or downhill with steep incline
 - Poor visibility due to factors such as fog, heavy rain, heavy snow, etc.
- The intelligent cruise control is a convenience feature for the driver. Do not use it as a safety device.
- The vehicle control should be determined by the driver at his/her own discretion. Relying on intelligent cruise control only increases the risk of accidents.

Steering wheel (steering force) control alert

If the driver does not hold the steering wheel while driving during intelligent cruise control's steering wheel control, the hands-off warning will be displayed to the driver in 3 steps and the intelligent cruise control system stops operating.



Step 1: Message

- Warning message is displayed.



Step 2: Message + Beep

- Warning message is displayed and beep sounds.



Step 3: Message + Beep (different from step 2)

- Warning message is displayed, and a beep different from one in step 2 will sound.



Step 3: Message + System disabled

- "Intelligent cruise control disabled" message is displayed and steering control is disabled at the same time. However, the cruise control still functions.



Caution

- If the driver hold the steering wheel so weakly that there is no left or right movement when driving on a straight road, the system may determine that the driver does not hold the steering wheel and may generate a hands-off warning.
- Hands-off warning may be issued late depending on the road conditions. Always hold the steering wheel while driving.

Notice

- For the safe operation of the driver, the IACC (Intelligent Adaptive Cruise Control) will be deactivated when the ignition switch is in the OFF position.
- In order to use IACC, you need to reset it.



Caution

The steering wheel (steering force) control system may not function or intervene unnecessarily under following circumstances:

- The system cannot recognize the lane markings because of rain, snow, dust, standing water or puddles, other obstruction on the road.
- The color of the lane markings is not clearly distinct from the road color.

- The lane markings are not clear or tampered by the traffic, or there are 2 or more lane markings on one side.
- There are other markings similar to the lane markings on the roads.
- The lane markings are covered in shadows of the median barriers, guardrails, noise barrier walls, roadside trees.
- There are environmental barriers, such as bollard.
- The traffic is heavy due to the construction in the area or traffic control items, such as traffic cones, are used to separate traffic flows.
- The lane markings are suddenly discontinued at roundabouts and road intersections.
- The vehicle is passing through a certain section, such as highway interchange, where the number of lanes increases or decreases.
- The width of the driving lane is too narrow or wide.
- The distance to the vehicle ahead is too short or a wheel of the vehicle ahead is touching the lane marker.
- There are other roadway markings on the roads, such as crosswalk markings, arrows, symbols, along with the lane markings.
- Poor visibility due to factors such as fog, heavy rain, heavy snow, etc.

- Hard to recognize other vehicles and pedestrians because of poor visibility.
- There is rapid change of illumination, for example at tunnel entry and exit points.
- The headlamps are not turned on or the brightness of the lamps is too low when driving at night or through tunnels.
- When you are traveling within or near the outer edges of the bus-only lane.
- The vehicle is driven on a steep hill or around sharp corners.
- the vehicle is driven under specific conditions which cause severe vibration.
- Objects with reflective surface (white paper, mirror, etc.) are on the dashboard.
- The windshield glass in front of the camera module is covered with ice, snow, slush, mud, dirt or debris.
- Fog or mist on the windshield.
- The temperature around the front view camera is too high because of the direct sunlight.
- The vehicle is moving towards a light source.
- The light from the sun, streetlamps, or headlamps of oncoming vehicles is reflected by the wet road surface.
- Bend such as sharp S-curve

To set safety distance to front vehicle

If the preceding vehicle is detected while the intelligent cruise control is operating, this system allows the driver's vehicle to maintain a distance to the preceding vehicle constant.

If the intelligent cruise control is activated, it will operate with the previously set safety distance without separate operation. If necessary, press the safety distance set button to change the inter-vehicle distance (safety distance) in 5 steps.

Set the safety distance according to the current vehicle speed.



Step 5 → Step 4 → Step 3 → Step 2 → Step 1
↑

- The set speed returns to the value before intelligent cruise control (IACC) was disabled.



- If no preceding vehicle is detected, the vehicle travels at a speed set to the intelligent cruise control system.
- When the preceding vehicle accelerates and the inter-vehicle distance increases, the driver's vehicle accelerates only up to the set speed and then travels at constant speed.

Forward situation awareness



If the distance to the front vehicle is so close that a collision can occur or the front vehicle disappears from the front view due to lane change, etc. while the intelligent cruise control is activated, the message is displayed on the instrument cluster.

- If the driver has to operate the brake pedal or steering wheel, immediately reduce the vehicle speed or change the direction.

Caution

- **If the front vehicle disappears from the front view due to lane change, etc. while traveling and maintaining the distance to the front vehicle constant at a low speed the driver's vehicle may collide with a newly appearing stationary vehicle or object.**

Starting at congested areas



When the intelligent cruise control is operating, in congested areas, drive the vehicle while maintaining the distance to the front vehicle constant. Depress the accelerator pedal or push up the speed selector lever toward RES+ briefly or lower it toward SET- briefly to restart the vehicle 3 seconds after since the vehicle stops due to the front stationary vehicle.

Front detection sensor (Front radar + front camera)

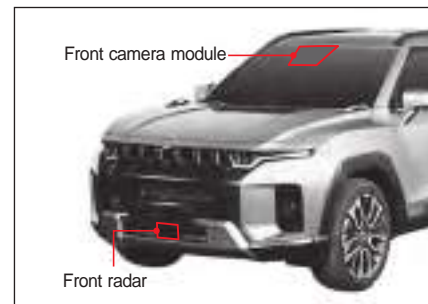



Front radar

It is a sensor that detects the front vehicle and allows the driver's vehicle to maintain the distance to the front vehicle constant and follow the front vehicle. If snow, rain, or foreign objects are stuck around the front sensor, the sensing performance of the sensor may deteriorate and intelligent cruise control may not function or may be temporarily disabled. Always keep the area around the front radar sensor clean.

Front camera

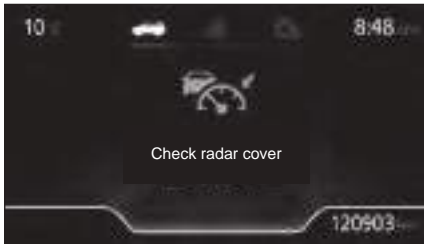
The camera detects the lane ahead of the vehicle through the sensor of the front camera module (FCM), allowing the vehicle to maintain the middle of the lane during intelligent cruise control operation. Always keep the area around the front camera module clean.



 **Caution**

- Always keep the area around the front detection sensor clean and never attach any accessory (license plate molding, sticker etc.).
- Be careful not to damage the sensor due to high-pressure washing or to prevent water from entering during car washing (lower part).
- After car washing, be sure to wipe off moisture around the sensor.
- Avoid subjecting the front bumper to impacts. The impact may change the sensing area of the sensor.
- Use a genuine sensor only.
- Do not paint the front bumper arbitrarily.

Vehicle detection is difficult under the following circumstances:

- Driving on a steep hill or sharp corners
- Driving under specific conditions which cause severe vehicle vibration
- A vehicle or a pedestrian recklessly cuts in front of you
- There is an approaching or reversing vehicle
- there is a vehicle with arbitrary shape
- Vehicle traveling close to one side lane or ahead
- Vehicle traveling at a very low speed or performing abrupt deceleration
- Stationary vehicle
- Vehicle with narrow rear structure (trailer, motorcycle, bicycle, etc.)
- When driving on a narrow road or a road with heavy curve
- When operating steering wheel
- When front part of vehicle lifted upwards due to excessive load in luggage compartment
- Foreign object stuck in sensor due to snow, rain, fog, etc.
- Vehicle which moves or is parked perpendicular to the direction of travel for your vehicle

 **Caution**

- The system may not recognize the preceding vehicle under the circumstances described earlier. Special care is required. Always be careful of motor traffic and reduce the vehicle speed by depressing the brake pedal, if needed.

Not detected preceding pedestrian

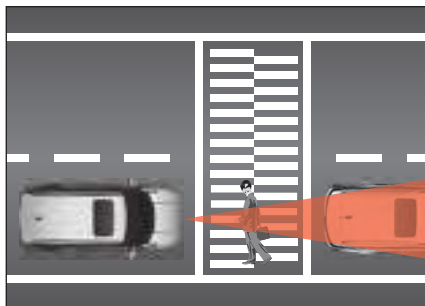

- The intelligent cruise control may not detect people.
- When traveling while maintaining the inter-vehicle distance, if a pedestrian appears in front of your vehicle, which can cause a dangerous situation.

Curved road



- The system may fail to recognize a preceding vehicle in the same lane on a curved road and accelerate the vehicle to the set speed rapidly.
- If the preceding vehicle is suddenly detected, the vehicle speed may decelerate rapidly.
- Always be careful of motor traffic and reduce the vehicle speed by depressing the brake pedal, if needed.



- It may detect a vehicle in a different lane on a curve and which may affect the driver's vehicle speed. Always be careful of motor traffic and reduce the vehicle speed by depressing the brake pedal.
- In this case, check the traffic conditions around you, then step on the accelerator pedal to prevent unnecessary deceleration.

Uphill or downhill

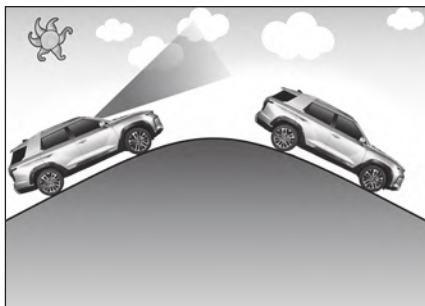

- The vehicle may accelerate to the driver set speed rapidly by failing to recognize a preceding vehicle in the same lane on an uphill or downhill.
- If the preceding vehicle is suddenly detected, the vehicle speed may decelerate rapidly.
- Always be careful of motor traffic on the uphill or downhill and reduce the vehicle speed by depressing the brake pedal, if needed.

To change lane

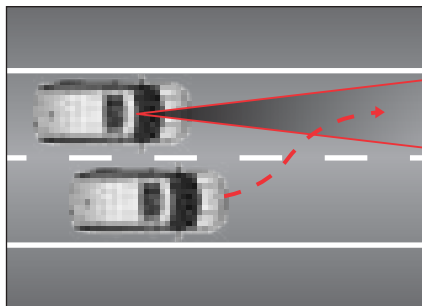

- When a vehicle in the lane next to you enters the same lane, the system may fail to recognize this vehicle until it enters into the sensor detection area.
- Be cautious at all times since the sensor may detect a vehicle cutting in suddenly late.
- Make sure to decelerate to maintain the vehicle-to-vehicle distance when an interposing vehicle's speed is lower than the driving speed.
- Make sure to keep the set speed to maintain the distance to a preceding vehicle when an interposing vehicle's speed is faster than the driving speed.

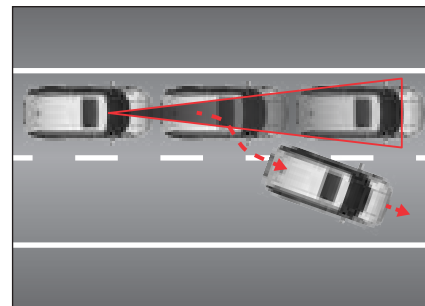

- If the front vehicle leaves the lane due to lane change, etc., be careful that there is a risk of collision because the system can not detect another vehicle ahead.

Detecting vehicle ahead

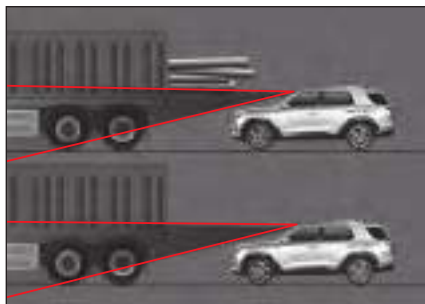

- Your attention is always required while driving behind a vehicle carrying cargo longer than the cargo bed or with high ground clearance because the AEBS may not work properly.

Warning

- In the event of an emergency, always stop the vehicle by depressing the brake pedal.
- Keep safety distance at all times. In particular, if you set the distance to the preceding vehicle to closer at high speed, it can cause a very dangerous situation such as collision with the front vehicle.
- The adaptive cruise control system can not cope with the vehicles parked in front, vehicle stopping suddenly, pedestrians, vehicles coming on opposite sides, etc. The driver should always be careful to look ahead and respond to unforeseen circumstances.
- If the preceding vehicle changes lanes frequently, the sensor recognition response rate may be slower. The driver should always be careful to look ahead and respond to unforeseen circumstances.
- The adaptive cruise control is a convenience device for the driver and not a safety device. The safe maneuvering and controls are always the driver's responsibility.

Warning

- The driver should always be aware of the adaptive cruise control set speed and distance to the front vehicle.
- Always allow for extra distance between your vehicle and the vehicle ahead. Reduce the vehicle speed by depressing the brake pedal, if needed.
- The adaptive cruise control can not recognize complicated traffic conditions, so you should always be careful about traffic conditions while it is operation and the driver must adjust the vehicle speed personally in dangerous situations.
- To use the adaptive cruise control more safely, be sure to read and familiarize yourself with the user manual before using it.

Caution

- The adaptive cruise control may be deactivated in an instant by strong electromagnetic waves.

Speed Limit*

The speed limit system is a safety device that prevents the vehicle from accelerating beyond the set speed even if the driver depresses the accelerator pedal on his/her own will.

Images that show readiness and operation

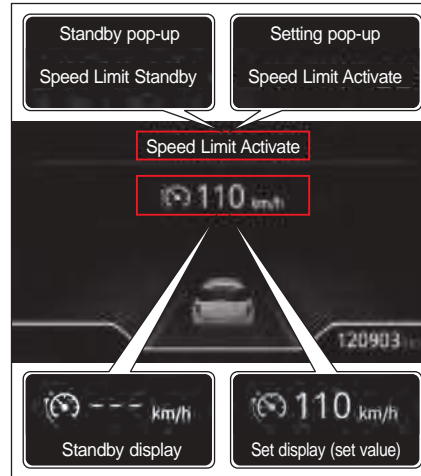

Speed limit ready

The following message is displayed on the instrument panel LCD screen and the system enters speed limit READY state when you press the speed limit ON/OFF switch.

- “Speed limit READY” pop-up displayed
- Symbol and “--- km/h” indicating that system ready to display speed displayed

To set speed limit

When the speed limit is in Ready state and the speed selector lever is lowered, the following message is displayed on the instrument panel LCD screen and the speed limit is set (activated).

- “Speed limit set” pop-up displayed
- Symbol and set speed displayed

How to enable speed limit in instrument cluster

- Go to **Driving Assist** → **Front Safety Aid** → **Speed Limit Warning** under  (User Settings) in the instrument cluster and tick the box.



- Press the speed limit ON/OFF switch twice with the speed limit control set (activated). The speed limit control will be deactivated. (pressing the switch once changes to standby (ready) state.)

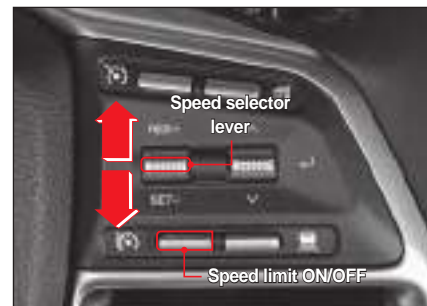
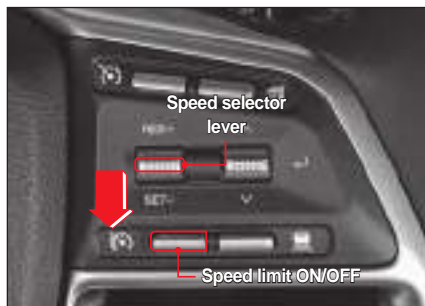

Notice

- If the tires of your vehicle are replaced with tires with different size at your disposal, it may cause an error in the set speed. In this case, please contact our service center.

To Turn Speed limit ON/OFF



- Press the speed limit ON/OFF switch. "Speed limit READY" message is displayed on the instrument cluster.
- Lower the cruise speed selector lever toward SET- to set (activate) the speed limit.
 - "Speed limit set" message is displayed on the instrument cluster.
 - After that, the vehicle will not accelerate beyond the set speed, even if the accelerator pedal is depressed.

To set speed

- When you raise or lower and hold the speed selector lever with the speed limit set (activated), the set speed is changed by 5 km/h.
- When you raise or lower the speed selector lever briefly with the speed limit set (activated), the set speed is changed by 1km/h.

To deactivate speed limit warning

- Operate speed limit warning ON/OFF switch twice
- Operate cruise control ON/OFF switch once

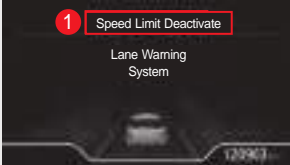
Item	Message	Operating conditions
Speed limit system		<ul style="list-style-type: none"> When you press the speed limit control ON/OFF switch with the ignition switch turned on, "Speed limit READY" message (1) and symbol (2) are displayed and the speed limit becomes ready.
		<ul style="list-style-type: none"> When you pull down the cruise speed selector lever with the speed limit ready, "Speed limit set" message (1), symbol and set speed (2) are displayed and speed limit is activated. Adjust the vehicle speed by pushing up or pulling down the speed control lever.
		<ul style="list-style-type: none"> If you disable the speed limit during its operation (ready / set), "Speed limit disabled" message is displayed and the speed limit control is deactivated.

Brake system

Warning Light and Indicator Related to Brake



ABS warning light



Parking brake ON indicator (red)



Electronic parking brake (EPB) warning lamp (orange)



Brake warning lamp



Electronic stability control (ESC) ON indicator/warning lamp



Electronic stability control (ESC) OFF indicator lamp



Hill descent control (HDC) ON indicator / warning lamp



AUTO HOLD indicator / warning lamp

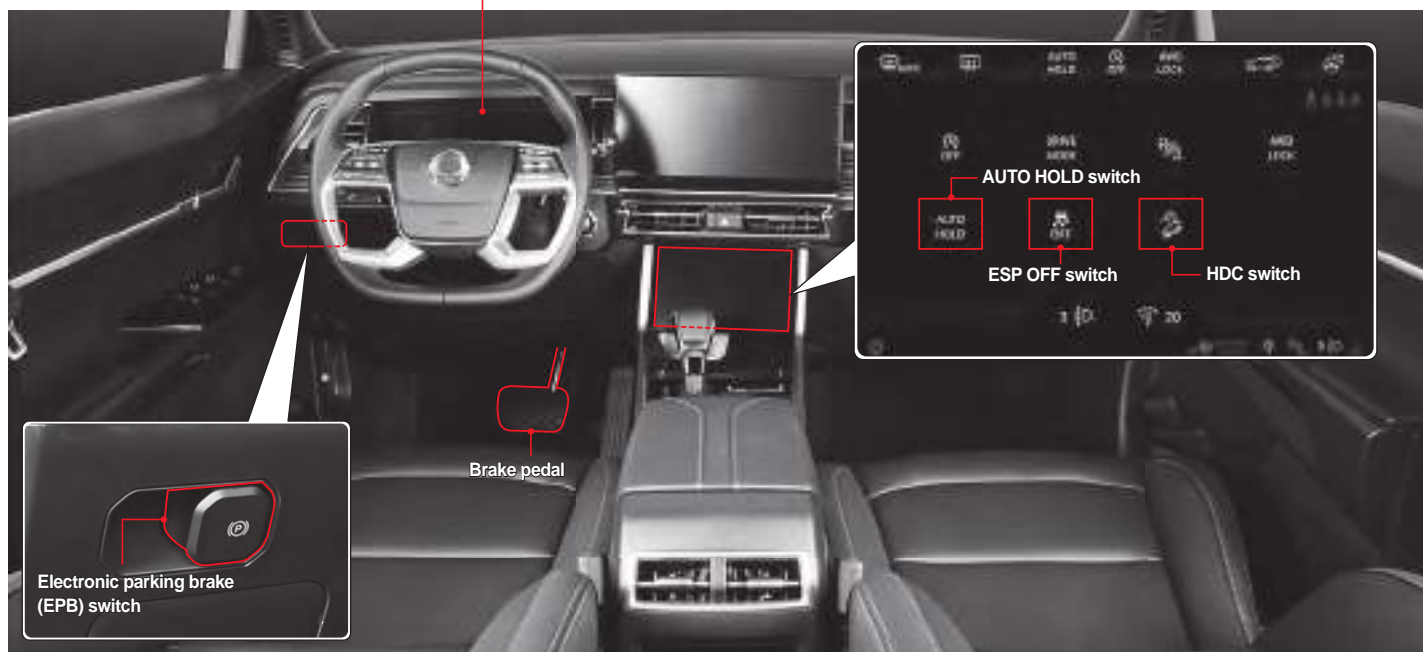

Foot brake

Depressing the brake pedal can reduce the vehicle speed or stop the vehicle.

If the foot brake is used for a long period of time on a long downhill road, the fade or vapor lock phenomenon may occur due to the overheating of the brake system, reducing the braking performance and causing an accident.

Use the engine brake with a lower gear along with the foot brake on a long downhill road.



Caution

- Reduce the speed properly using the engine brake on a slippery road such as an icy road or a snowy road.

What is the fade phenomenon?

The fade phenomenon is the reduction of braking force due to a decrease in the friction force caused by a temperature increase in the friction surface of a brake when the brake is applied excessively on a long downhill road.

What is the vapor lock phenomenon?

The vapor lock phenomenon is the condition that when the brake is applied excessively on a downhill road, bubbles form in the brake fluid in the wheel cylinder or brake pipe of the hydraulic brake so that proper hydraulic pressure cannot be transferred, causing the brake system not to operate properly even if the pedal is depressed.



Warning

Checking for foreign materials on the pedal operation area



- Before driving the vehicle, clean up the area where the brake pedal or the accelerator pedal is operated. If an empty can or an article is present below the pedal, it may obstruct the pedal operation, causing an accident. Be sure to check before driving the vehicle.

Checking and replacing the brake pads/discs

Check the brake pads and discs at every 15,000 km of driving and replace if necessary. When replacing the brake pad, replace the left and right brake pads at the same time.

The replacement period of the brake pads and discs may vary depending on the driver's driving habit.



Warning

- **If you hear a screeching sound when you depress the brake pedal, have your vehicle checked and serviced at a nearby KG Mobility Authorized Service Center. Failure to do so may cause the brake not to operate, causing a serious accident.**

If the brake is not working

If the foot brake is not working while driving, decelerate the vehicle speed as much as possible using the engine brake and stop the vehicle safely by applying the parking brake slowly.

ABS (Anti-Lock Brake System)

If you apply sudden braking or apply braking on a slippery road, the vehicle continues to move forward but the wheels are locked, not rotating. In such case, steering may not be possible or the vehicle may spin, causing an accident.

In such case, the ABS controls the locking of the wheels properly to maintain the steering force and improve the steering stability of the vehicle.

In normal driving conditions, the braking system of a vehicle equipped with the ABS operates in the same way as the braking system of a normal vehicle.



Warning

- **The ABS system prevents a situation that the wheels are locked, disabling the steering of the vehicle, when the braking is applied. Therefore, the ABS system does not affect the braking distance significantly.**
- **When the ABS system operates and the braking force is created, the braking distance may become longer or shorter than the braking distance of a vehicle without the ABS system according to the road surface condition.**
- **When applying a sudden braking, depress the brake pedal strongly until the vehicle stops completely. Never take your foot off from the pedal or depress the pedal in a pumping manner.**
- **Even a vehicle equipped with the ABS system cannot prevent a risk of the vehicle skidding sideways. Be sure to keep a proper safe distance from a preceding vehicle and drive the vehicle at a low speed on a slippery road.**



Caution

- A vehicle equipped with the ABS system performs the self-diagnosis function to check whether the system is abnormal or not after the engine is started and the vehicle is driven. In this process, the hydraulic pressure is transferred to the internal hydraulic system forcibly and the motor operates accordingly, so noises and vibrations may occur on the brake pedal. This indicates that the ABS is functioning normally.
- When the ABS system operates, you may feel vibrations through the brake pedal along with some noise. This is a normal phenomenon that occurs when the ABS system operates.

ABS warning light



This warning light turns on when the START/STOP switch is in the ON status and it turns off if the system is normal.



Warning

- If the ABS warning light stays on after the engine is started or it turns on while driving, this indicates that an ABS-related system is abnormal, and the ABS system does not operate and only normal braking function is activated. In such case, have your vehicle checked and serviced at a KG Mobility Authorized Service Center promptly.

Electronic Brake-Force Distribution (EBD)

The EBD system distributes the braking force to the front wheels and the rear wheels efficiently by controlling the braking pressure electronically when the brake pedal is depressed.

The EBD system is activated when the speed difference between the fastest front wheel and the slowest rear wheel is approximately 1 km/h or more, and it is deactivated when the ABS operates.

Brake warning lamp



This warning light turns on when the ignition switch is set to the ON position and turns off when there is no fault in the system.



Caution

- When the EBD warning light turns on, have your vehicle checked and serviced at a KG Mobility Authorized Service Center.

Emergency Stop Signal (ESS)

The ESS function informs of a dangerous situation to a following vehicle by blinking the emergency braking light fast when a sudden braking is applied or the ABS system operates while driving.

The ESS function operates when the vehicle speed is 50 km/h or higher, and it operates in the sequence of "Input ESS signal" → "Operate emergency braking light" → "Operate the hazard warning lamp".

Notice
<ul style="list-style-type: none">• If the hazard warning lamp is on, the ESS function is not activated.

Activation and deactivation conditions

	Emergency braking light
Activation conditions	<ul style="list-style-type: none">• When the vehicle speed is 50 km/h or higher• When a sudden braking with the vehicle deceleration of 6.5m/s² or higher is applied• When the ABS system is operating while applying braking
Deactivation conditions	<ul style="list-style-type: none">• If there is no ESS from the vehicle• When the hazard warning lamp is activated• When the ABS operation is finished

	Hazard warning lamp
Activation conditions	<ul style="list-style-type: none">• If the vehicle speed is 50km/h or less at the time when the operation of the hazard warning lamp indicator is finished (canceled)• If the hazard warning lamp blinks for 10 seconds
Deactivation conditions	<ul style="list-style-type: none">• When the hazard warning lamp is activated• When 10 seconds have passed after the hazard warning lamp is activated• When the vehicle speed has increased by 10 km/h or more after the hazard warning lamp is activated

Electronic stability control system (ESC)

The ESC system is an auxiliary driving safety system that controls the braking of each wheel or the engine output in order to correct the vehicle stability when it becomes unstable such as rapid cornering, helping the vehicle to avoid a dangerous situation.

- The ESC function is activated only when the vehicle becomes extremely unstable and it is not activated in normal driving conditions. You can confirm its activation from the blinking of the ESC indicator on the instrument cluster.

ESC indicator/warning light



- Indicator blinks: When the ESC function is activated
- Warning light turns on: When the ESC system is abnormal

Caution

- If the ESC indicator blinks, drive slowly without accelerating.
- If the ESC warning light turns on, visit a KG Mobility Authorized Service Center and have your vehicle checked and serviced.

Notice

- The hazard warning lamp blinks for approximately 10 seconds to allow a vehicle right behind or around to prepare in advance when you apply sudden braking at the vehicle speed of 50 km/h or higher or the ABS system operates. (Emergency Stop Signal)

ESC OFF indicator



A light touch of the ESC OFF switch will stop the ESC operation and illuminate the indicator.

Caution

- If the ESC OFF indicator stays on even though you did not deactivate the ESC function, visit a KG Mobility Authorized Service Center and have your vehicle checked and serviced.

Notice

- A light touch of the ESC OFF switch will illuminate the ESC OFF indicator and the ESC function will not operate.
- Autonomous emergency braking (AEB) operates normally even when the ESC is turned off.

Phenomenon that occurs when the ESC is activated

If the ESC is activated due to tight cornering, the ESC controls each wheel, so you can feel that the braking is applied to the relevant wheel, and vibrations on the brake pedal and noises may occur due to a change in the hydraulic pressure inside the system.

Also, the engine RPM may not increase due to the engine output control function if you depress the accelerator pedal.

When it is necessary to deactivate the ESC function

If the left and right driving wheels are slipping on a snowy road or an icy road continuously, the ESC function is activated to control the engine driving force. Accordingly, the engine RPM cannot be increased even if you depress the accelerator pedal, disabling you to drive the vehicle.

In such case, deactivate the ESC function to restore the engine driving force so that you can drive the vehicle.

- To deactivate the ESC function, press and hold down the ESC OFF touch switch (for 3 seconds or more).

The ESC OFF indicator on the instrument cluster turns on and the ESC function is deactivated.

- Pressing the ESC OFF touch switch again activates the ESC function.



Warning

- Do not touch the ESC OFF switch while the ESC is operating. Touching the ESC OFF switch to interrupt the ESC function during rapid acceleration on a slippery surface or swivel acceleration may cause the vehicle to slip suddenly, leading to a very dangerous situation. Always deactivate the ESC function by touching the ESC OFF switch only when driving at a constant speed on a straight, flat road.

Notice

A vehicle equipped with the ESC includes various auxiliary functions for improving the driving safety of the vehicle. The typical functions are as follows.

- BAS (Brake Assist System)

The BAS function detects a sudden braking situation and increase the brake pressure for a driver with leg strength who cannot apply sudden braking in a sudden braking situation.

- ARP (Active Roll-over Protection)

The ARP is an auxiliary safety function that helps the vehicle to maintain normal stability prior to the ESC when the driving status of the vehicle is highly unstable.

Caution

- The ESC is just a driving safety assist system of the vehicle and it cannot control the vehicle beyond its physical limitation. Do not rely too much on this system and be sure to drive safely.
- The activation of the ESC (the ESC indicator blinks) indicates that the vehicle is highly unstable. In such case, reduce the vehicle speed and drive the vehicle safely.
- The ESC is not activated when reversing the vehicle.

- Do not drive the vehicle immediately after starting the engine. When you drive the vehicle within 2 seconds after starting the engine, the self-diagnosis function of the ESC is not carried out and the ESC is activated in early stage while driving so that symptoms such as the ESC warning light turning on, warning buzzer and the generation of braking force on each wheel may occur.
- When the ARP function is activated, the braking of the engine and each wheel is controlled more powerfully in comparison to normal ESC operation, so the vehicle speed may decrease rapidly or strong braking force on each wheel is created, making the steering status unstable.
- When the ESC operates, vibrations and noises may occur on the brake pedal and other relevant devices due to a change in the hydraulic pressure inside the device.
- A vehicle equipped with the ESC may have slight vibrations while the self-diagnosis function is being carried out for the system, but this is a normal phenomenon.

Hill Descent Control (HDC)

HDC is the system that decelerates the vehicle automatically to allow the driver to drive the vehicle at a low speed without depressing the brake pedal when the driver intends to drive the vehicle on a steep road at a low speed.

The variable type HDC applied to this vehicle operates flexibly in the range between 5 km/h and 30 km/h according to the vehicle environments (operation status of brake and accelerator pedal).

Warning

- Do not use the HDC function on a normal road. The HDC function is for driving on a downhill road, and using it on a normal road may cause a collision with a following vehicle.

Activating/deactivating the HDC function

- Lightly touching the HDC switch turns on the HDC indicator on the instrument cluster and set the HDC system in Standby state.
- Touching the HDC switch again turns off the HDC indicator and deactivates the HDC function.

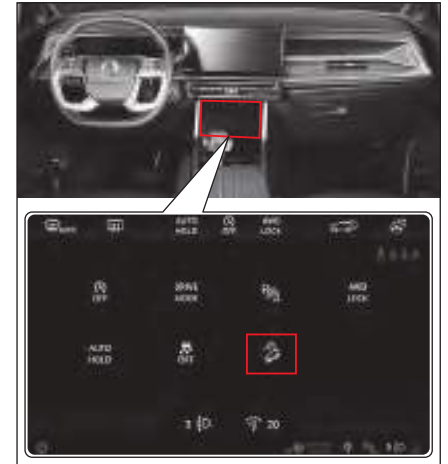

HDC indicator/warning light



- Green indicator turns on: HDC in ready status
- Green indicator blinks: The HDC is operating.
- Red warning light turns on: The HDC system is overheated and abnormal.

Caution

- **When the red warning light turns on, the HDC function is not activated.**
- **When the red HDC indicator turns on, it indicates that the HDC system is overheated or abnormal. If the red HDC indicator stays on after the HDC-related device has been cooled down properly, have your vehicle checked and serviced at a KG Mobility Authorized Service Center.**

HDC activation conditions

- When the HDC function is activated (green HDC indicator turns on)
- Within a certain degree of slope or higher and the operating speed range (approximately 2 km/h ~ 50 km/h)
- When the ESC function (including the BAS function) is not activated

HDC deactivation conditions

- When the HDC function is deactivated (green HDC indicator turns off)
- Degree of slope below the HDC activation condition
- When the vehicle speed is less than 2 km/h or more than 50 km/h
- When the HDC system is abnormal
- When the HDC system is overheated

Notice

- **While the HDC function is being activated, the driver can accelerate or decelerate the vehicle to the desired speed (approximately 5~30km/h) for driving by depressing the brake pedal or the accelerator pedal. However, if the vehicle speed is less than 2 km/h or more than 70 km/h, the HDC function is deactivated.**

HDC operation

If the conditions for activating the HDC are met, the HDC is activated and the green HDC indicator on the instrument cluster blinks. If the vehicle speed becomes less than 2 km/h or more than 70 km/h or the sloping road becomes gentle while the HDC function is being activated, the HDC operation stops.

While the HDC function is operating, strong operating sounds and vibrations occur on the brake and this is normal according to the HDC operation.

Caution

- **The HDC function is for off-road driving on a steep downhill road.**
- **If the HDC function is used frequently, the brake system or the ESC may not operate normally.**
- **Avoid using the HDC function when driving on a normal road. If you drive the vehicle with the HDC ready status on a flat road, the HDC function may be activated when you make a tight cornering or pass through a speed bump.**
- **When the HDC is activated, vibrations and noises occur on the brake pedal and other relevant devices due to a change in the hydraulic pressure inside the device. This is a normal phenomenon according to the activation of the HDC.**

Electronic Parking Brake (EPB)

The EPB is the parking brake system with enhanced safety and stability that the parking brake is applied and released through a simple switch operation.



Warning

- Do not allow a person who is unfamiliar with the EPB (especially a child) to operate the EPB. Failure to do so may cause an accident according to the parking and stopping status.

Caution

- When the temperature falls down below zero during winter, the parking brake may not be released due to the freezing of EPB-related devices.
- Driving the vehicle forcibly with the parking brake not released due to the freezing of a EPB-related device may damage the relevant device. Noises may also occur when driving the vehicle.
- When you park the vehicle on a flat and safe place in a weather with below zero temperatures, use a chock on the wheels after parking instead of using the EPB.

Applying the EPB

- 1 Park the vehicle on a flat and safe place.
- 2 Pull the EPB switch.
The parking brake warning light on the instrument cluster turns on and the EPB is applied.



4

Releasing the EPB

With the brake pedal depressed, press the EPB switch.

The parking brake warning light on the instrument cluster turns off and the EPB is released.



Releasing the EPB automatically

When you fasten the seat belt with the driver seat door, engine hood and tailgate closed and drive the vehicle normally, the EPB function is released automatically.

Notice

- If the driver seat door, engine hood or tailgate is not closed or the seat belt is not fastened, the EPB auto release function is not activated.

EPB warning light/brake warning light

EPB warning light



- The EPB amber warning light turns on when the EPB system is abnormal.

Parking brake ON indicator (red)



The warning light turns on in any of the following situations.

- When the parking brake is operating normally
- When the gear shift lever is moved to the P (parking) position with the AUTO HOLD activated

! Caution

- When applying or releasing the EPB, check if the parking brake warning light turns on or off on the instrument cluster.
- If the EPB switch is operated abnormally (excessive or continuous operation), the EPB warning light may turn on. At this time, when you turn off the engine and turn the START/STOP switch in the ON status, the warning light turns off and the EPB operates normally.
- If the EPB warning light stays on, have your vehicle checked and serviced at a KG Mobility Authorized Service Center.
- If the parking brake warning light stays on even though the parking brake has been released, have your vehicle checked and serviced at a KG Mobility Authorized Service Center immediately.

EPB emergency mode

When you pull the EPB switch up if the brake system malfunctions or you cannot depress the brake pedal while driving, the EPB is applied while the EPB is being pulled.

However, the braking distance may increase significantly in comparison to normal brake operation.

! Warning

- **Never use the EPB emergency mode while driving unless it is an emergency. Doing so may damage the vehicle system and may make the driving status unstable due to the braking force while driving, resulting in an accident.**
- If the brake system has a critical failure, the EPB emergency mode may not operate.

! Caution

- If you need to park the vehicle with a faulty EPB, place the gear shift lever in the P (parking) position and park the vehicle on flat ground.
- If a noise or a smell of burning occurs from the relevant devices after operating the emergency mode, have your vehicle checked and serviced at a KG Mobility Authorized Service Center.



Caution

- Before driving, be sure to check if the parking brake warning and the low oil warning light on the instrument cluster turn on.
- Be sure to release the parking brake before driving. Driving the vehicle with the parking brake applied may damage the brake system.
- When you use the parking brake for stopping while driving, move the gear shift lever to the P (parking) position or the N (neutral) position for safety.
- Do not use the P (parking) position of the gear shift lever instead of the parking brake. Be sure to apply the parking brake firmly when stopping or parking the vehicle.
- If you intend to place the gear shift lever in the N (neutral) and park the vehicle, turn off the engine with the gear shift lever in the P (parking) position, press the Gear shift lever unlock button and move it to the N (neutral) position.
- Be sure to place the gear shift lever in the P (parking) position when parking or stopping the vehicle. If the gear shift lever is not in the P (parking) position when parking or stopping, the vehicle may move due to an impact from the outside or along the road surface.

When parking the vehicle on a uphill road

- When you park the vehicle on an uphill road, park the vehicle with the steering wheel turned in the opposite direction from the curb.

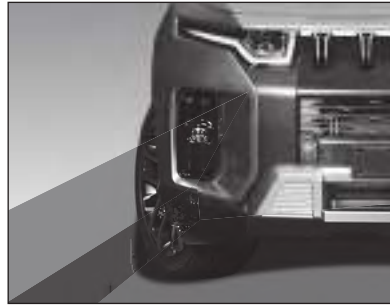

When parking the vehicle on a downhill road

- When you park the vehicle on a downhill road, park the vehicle with the steering wheel turned in the direction toward the curb.

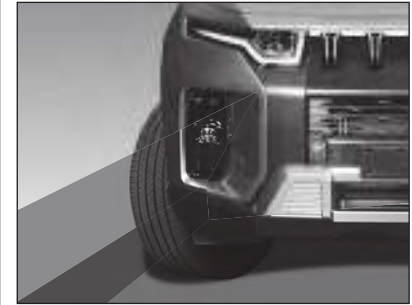

AUTO HOLD

When the "AUTO HOLD" function is activated, the vehicle keep the brake pressure in order to hold the vehicle stationary when you stop the vehicle by depressing the brake pedal in order to wait for a signal or in case of traffic congestion.

- In R (reverse) position, the AUTO HOLD function does not work.
- When you depress the accelerator pedal, the brake is released automatically, allowing you to drive the vehicle.



To Set / Deactivate AUTO HOLD Function

- Lightly touching the AUTO HOLD switch sets the AUTO HOLD function.
- When the AUTO HOLD function has been set, lightly touching the AUTO HOLD switch deactivates it.
- If you turn the ignition off and back on, the AUTO HOLD function will be deactivated.
- When the ignition switch is turned off and turned on back, the AUTO HOLD function maintains the state before turning off the ignition.

Using the AUTO HOLD function

- 1 Touch the AUTO HOLD switch.
The AUTO HOLD indicator (white) on the instrument cluster turns on.
- 2 Stop the vehicle completely by depressing the brake pedal while driving.
The color of the AUTO HOLD indicator changes from white to green and the brake is applied.
- 3 Depress the accelerator pedal slowly when driving the vehicle.
The color of the AUTO HOLD indicator changes from green to white, and the brake is released.

Warning

- When you drive the vehicle on a downhill road, do not depress the accelerator pedal suddenly. Doing so may cause the vehicle to move fast, causing a dangerous situation.

AUTO HOLD indicator/warning light



- White indicator turns on: AUTO HOLD function in ready status.
- Green indicator turns on: AUTO HOLD function is activated and maintain the brake pressure to keep the vehicle stationary.
- Yellow warning light turns on: When the AUTO HOLD system is abnormal.

Caution

- The Auto Hold does not operate when:
 - The driver's door is opened
 - The engine hood is opened
 - The tailgate is opened
 - The gear shift lever is in 'P'(Park) position
 - The EPB is applied
- The 'Auto Hold' automatically switches to EPB in such cases:
 - Shifted to P (park) position
 - The driver's door is opened
 - The engine hood is opened
 - The tailgate is opened
 - The vehicle is in a standstill for more than 10 minutes
 - The vehicle is standing on a steep slope
 - Ignition turned off

Caution

- In R (reverse) position, the AUTO HOLD function does not work.
- Be sure to deactivate the AUTO HOLD function if wheel drive is necessary such as automatic car wash.
- During the break-in period of parking brake pads, the braking force of the parking brake may be slightly reduced. (If the vehicle is parked on a sloping road, the vehicle may roll down.)
- Check the brake pads for wear and the operation status of the Electronic Parking Brake (EPB) every 10,000 km.
- When the Electronic Parking Brake (EPB) is applied, a mechanical operating sound may occur. This is a normal operating sound of the Electronic Parking Brake (EPB) system.
- If the Electronic Parking Brake (EPB) warning light turns on, the Electronic Parking Brake (EPB) operation is abnormal, have your vehicle checked and serviced at a KG Mobility Authorized Service Center. If you need to park the vehicle in case of emergency, stop the vehicle on flat ground, place the gear shift lever in the P (parking) position and use a chock on the wheels.

Autonomous Emergency Braking (AEB)*

The AEB (Autonomous Emergency Braking) is an assist device that warns the driver of the risk of collision when a collision with the front vehicle or pedestrian is expected by the sensor of the front sensor module (front camera module and front radar).

This system informs the driver about the collision risk with the warning message and warning buzzer according to the level of collision risk. If this collision risk persists, this system controls the braking force to avoid collision or relieves the shock when a collision occurs, improving the safety of the driver and pedestrians.

1st collision alert → 2nd collision warning → 3rd emergency braking → Vehicle stop



Warning

- AEB is only an auxiliary system for helping the driver to secure safety in a dangerous situation and it does not avoid a collision situation automatically. The driver is responsible for the vehicle safety and control.

Notice

- The AEB is set and Medium is set for the sensitivity of the forward collision warning as the factory default settings.

AEB indicator/warning light

AEB OFF indicator



The AEBS OFF indicator lights up on the instrument cluster when the AEB function is disabled.

Notice

- A light touch of the ESC OFF switch will illuminate the ESC OFF indicator and the ESC function will not operate.
- Autonomous emergency braking (AEB) operates normally even when the ESC is turned off.

AEB indicator/warning light



The AEB indicator and warning light operate as follows depending on the AEB status.

- Blink: AEB is operating
- Turn on: AEB is abnormal

A warning message is displayed on the display of the instrument cluster as follows according to the AEB status.

AEB is operating



AEB is abnormal



AEB is activated

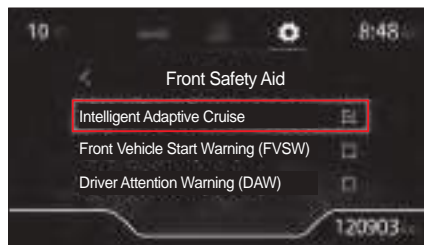

When you put a check mark on  (User Settings) → Driving assist → Front Safety Aid → AEB (Automated Emergency Braking) from the instrument cluster, the function is activated and the AEB OFF indicator on the instrument cluster turns off.

When you remove the check mark from the AEB, the function is deactivated and the AEB OFF indicator turns on.

Caution

- Activate or deactivate the AEB system before driving the vehicle or after stopping the vehicle at a safe place for safety.
- When the ESC function is deactivated, the AEB function is also deactivated automatically even if it was activated previously. The AEB function can also be activated from the User Settings menu on the instrument cluster.

Setting the sensitivity of the forward collision warning

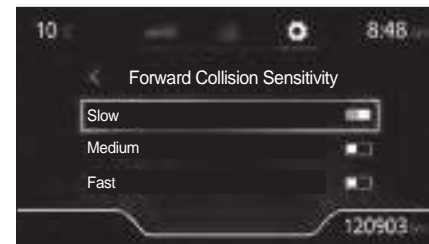



You can change the setting from  (User Settings) → Driving assist → Forward Collision Sensitivity on the instrument cluster.

- If Fast is set, the AEB warning is issued fast.
- If the AEB warning is too fast, set it to Medium or Slow.

Caution

- Even if Fast is set for the sensitivity of the AEB warning, you may feel it is slow when a front vehicle applies a sudden braking.

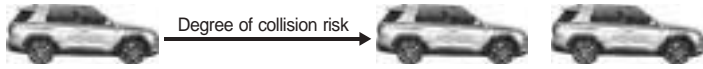
AEBs operation

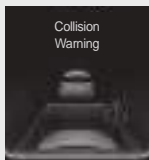
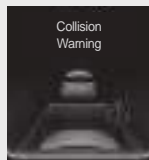
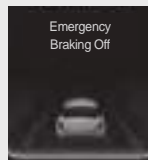
	Collision alert (1st warning)	Collision alert (2nd warning)	Emergency braking (3rd warning)	Vehicle stop
Classification				
Display window of the instrument cluster				
Warning buzzer	Sounds 7 beeps for 1 second			-
Vehicle control	-	The system applies partial braking.	Full brake control before collision.	Maintain the braking force for approximately 2 seconds after the vehicle stops.



Warning

- The AEB is an auxiliary system that helps the driver to secure safety in a dangerous situation and it does not guarantee safety.
- The AEB does not recognize all urgent and dangerous situations.
- Do not attempt dangerous driving for activating the AEB.
- The AEB does not avoid a collision situation automatically. The driver is responsible for the vehicle safety and control.
- Always secure safe braking distance and depress the brake pedal to reduce the vehicle speed if necessary.
- The AEB is activated according to the distance from a front vehicle or a pedestrian, relative speed and the driver's response.
- The AEB detects the driving situation through the front sensor module (front camera module and front radar). If the driving situation is not covered by the front camera, the performance of the system may deteriorate.

Activation conditions

When the following conditions are met after the AEB is activated, the system operates normally.

- When the AEB is activated
- When the Electronic stability control system (ESC) is activated
- When the Front Camera Module (FCM) recognizes a vehicle and a pedestrian at the front normally
- When the vehicle speed is between 8 km/h and 60 km/h

Notice

- **The AEB is ready to operate in preparation of an urgent (dangerous) situation and when the driver depresses the brakepedal, this auxiliary system responds promptly.**
- **When the AEB is activated, it supplements the optimal braking force required for decelerating the vehicle.**
- **If the urgent (dangerous) situation is cleared, the AEB control stops.**
- **The 1st warning is activated up to the vehicle speed of 180 km/h.**

Deactivation conditions

When the following conditions are met after the AEB is activated, the system is deactivated and the AEB does not operate.

- When the AEB is deactivated
- When the vehicle speed exceeds 60 km/h
- When the steering wheel is operated
- When the gear shift lever is placed in the P (parking) or the R (reverse) position
- When the accelerator pedal is depressed

The AEB cannot detect a vehicle properly:

- on a sharply curved section or a steeply sloping road
- when the vehicle wobbles significantly
- when the tail lights of a front vehicle are asymmetrical or are not turned on at night
- when the rear side of a front vehicle is asymmetrical
- when a vehicle cuts in suddenly
- An animal, an object or a vehicle driving, or when the vehicle is driving in the opposite direction
- An approaching vehicle or a vehicle that is reversing
- An odd-shaped front vehicle
- When there is rapid change of illumination (tunnel entrance, etc.)
- When the shape is not visible due to shade right below an overpass

- There is poor visibility due to bad weather such as snow, rain and fog
- When the moisture formed on the glass of the windshield is not removed completely
- When the reflection from an object placed on the dashboard panel obstructs the recognition of the Front Camera Module (FCM)
- When there is a narrow object such as a motor cycle or a bicycle in front of the vehicle
- A vehicle moving or stopping perpendicularly to the driving direction at an intersection



Caution

- **The driver's attention is required since the AEB may not respond normally or the system may malfunction when it is difficult to detect a vehicle.**

Curved road



On a curved road, a front vehicle on the same lane cannot be detected and the AEB performance is reduced so that unnecessary warning or braking is applied or the system may not operate.

Check the front road and driving conditions on a curved road and adjust the vehicle speed directly by depressing the brake pedal if necessary.



A vehicle on another lane may be detected, affecting the speed. Check the front road and driving conditions and adjust the vehicle speed directly by depressing the brake pedal if necessary.

In such case, you can prevent unnecessary deceleration by depressing the accelerator pedal.

Sloping road

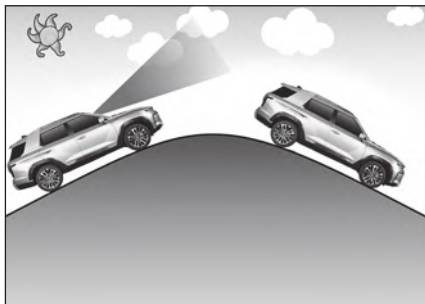

On a uphill road or a downhill road, a vehicle on the same lane cannot be detected and the AEB performance is lowered so that unnecessary warning or braking is applied or the system may not operate.

Also, a front vehicle is detected suddenly and the warning and braking may be applied.

Check the front road and driving conditions on a uphill road or a downhill road and adjust the vehicle speed directly by depressing the brake pedal if necessary.

When changing the lane

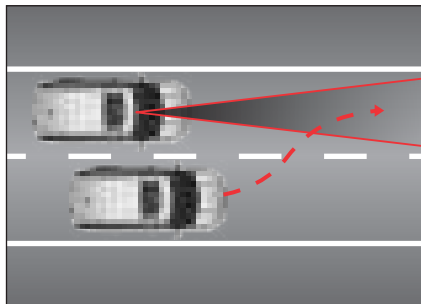

When a vehicle on the next lane changes the lane to the same lane, the vehicle may not be detected until it enters the detection range of the Front Camera Module (FCM).

Always pay attention since a vehicle that cuts in suddenly may be detected late.

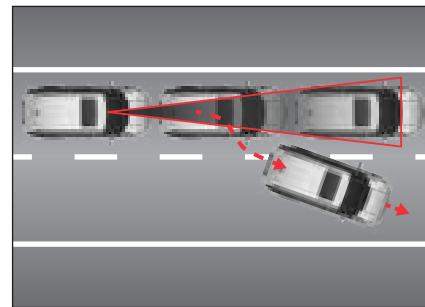

Caution should be taken that if there is a vehicle stopped in front of the vehicle ahead and the vehicle ahead moves out of the lane while your vehicle has been decelerated due to the AEB operation, the vehicle stopped at the front is not selected as the control target, causing a collision risk.

Recognition of a vehicle ahead

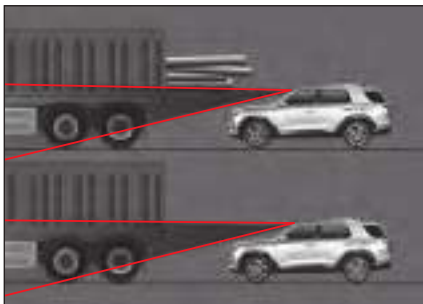

Caution should be taken that a tall vehicle or a vehicle with cargo sticking out the back of the vehicle may cause a dangerous situation.

The AEB cannot detect a pedestrian

- who is not standing normally
- whose body is hidden or who does not walk upright
- who moves fast
- who cuts in suddenly
- who wears clothes in a color similar to the background
- when the surrounding illumination intensity is too high or too low
- at night or when the surrounding area is dark
- if there is a structure similar to a person
- if he/she is short
- whose behavior is unstable
- When there is a situation that disables the AEB to detect a pedestrian by environments
- when there are many people gathered together
- When there is an object (cart, bicycle, two-wheeler, suitcase, stroller, etc) pushed by the pedestrian



Warning

- The AEB is not activated in all situations. Therefore, do not test the AEB targeting a person or an object. Doing so may cause serious injury or death.
- When you start the vehicle, the AEB is always activated automatically. If you need to deactivate the function, use the User Settings menu on the instrument cluster.
- If the AEB is activated and you apply a sudden braking, occupants in the vehicle may face danger. Therefore, always pay attention just in case.
- If the front camera is stained with foreign materials, its detection function is lowered and the AEB is deactivated temporarily. Always keep the camera clean.
- If the front camera has deviated from its normal position due to a shock, the system may not operate normally even if the warning light does not turn on or the warning message is not displayed on the instrument cluster.
- At night, the vehicle and pedestrian detection performance may be lowered since the lighting condition is poor in comparison to daytime.
- If frost forms on the windshield during winter, the front camera may not detect normally. Be sure to remove the frost.

- Failure to do so may result in unnecessary warning and braking, and the warning and braking may not be applied due to the detection limitation of the sensor.
- If a vehicle ahead applies a sudden braking, proper brake application may not be carried out, causing a collision. Always pay attention in preparation for a dangerous situation.
- If you tow another vehicle or a trailer, cancel the AEB setting. Applying braking while towing may lower the safety of the vehicle.
- When you load the vehicle on a truck, a train or a ship that transports a vehicle, deactivate the AEB. The system may be activated according to the contact condition in the loading process.



Caution

- The AEB may be deactivated temporarily by a strong electromagnetic wave.
- Do not tint the Front Camera Module (FCM) detection area. Doing so may cause the relevant system to malfunction or not to operate.

Part prohibited for tinting (FCM detection area)



Rear and side warning system*

The rear and side warning system is an auxiliary system that detects and informs the blind spot area that cannot be detected by the driver using the detection sensor located inside of both edges of the rear bumper.

- The rear and side warning system includes the following warning systems.
 - Blind spot-detection warning (BSW) system
 - Blind spot collision assist (BSA) system
 - Lane change warning (LCW) system
 - Rear cross traffic warning (RCTW) system
 - Rear cross traffic assist (RCTA) system
 - Safety exit warning (SEW) system

Display of rear and side warning system activation



When the outside rearview mirror warning light blinks twice with the START/STOP switch in the ON status or while the engine is running, it indicates that the rear and side warning system is operating normally.

Note

- You can change the BSW system settings in User Settings in the instrument cluster.

Warning

- The rear and side warning system is an auxiliary system that helps the driver to drive the vehicle safely. Avoid depending on the rear and side warning system in any case and drive the vehicle while checking the road condition.

Caution

- Always keep the rear bumper clean. The sensor that detects the rear and both sides of the vehicle is installed inside of both edges of the rear bumper. If the rear bumper is stained with foreign materials, the sensors may not function normally.
- When the rear bumper is replaced, painted or repaired, the system operation performance may be lowered.
- The detection sensors of the system may not operate depending on the surrounding environment. Drive the vehicle while checking the road condition directly for an emergency situation.
- Failure to do so may cause the system to malfunction due to a strong electromagnetic wave.

Warning Steps in BSW System

A first warning or second warning is issued when a vehicle approaching at a driving speed that matches the function settings of the blind spot-detection warning system is detected.

1st warning

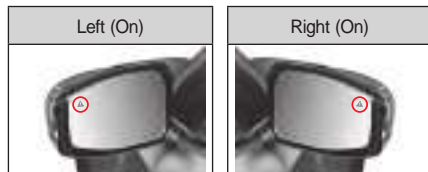

- Red warning lamp flashes on outside rearview mirror
- Functions affected by first warning
 - Blind spot-detection warning (BSW) system
 - Lane change warning (LCW) system

2nd warning

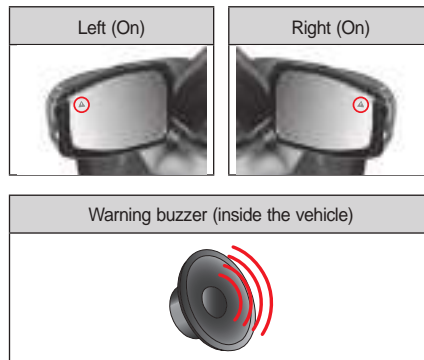

- Red warning lamp flashes on outside rearview mirror
- Warning buzzer sounds in vehicle
- Functions affected by second warning
 - Blind spot-detection warning (BSW) system
 - Blind spot collision assist (BSA) system
 - Lane change warning (LCW) system
 - Rear cross traffic warning (RCTW) system
 - Rear cross traffic assist (RCTA) system
 - Safety exit warning (SEW) system

When the rear and side warning system is abnormal



When the rear and side warning system is abnormal, a warning message is displayed on the display of the instrument cluster.

Caution

- **When the warning message on the faulty RCTW is displayed, all the RCTW relevant functions are disabled.**
- **If the warning message persists, have your vehicle checked and serviced at a KG Mobility Authorized Service Center.**

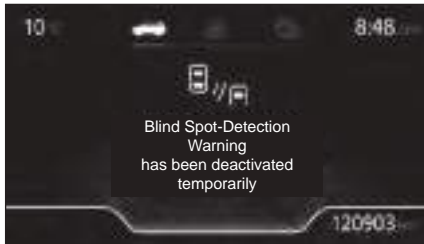

If the sensor cannot detect the rear and both side areas of the vehicle normally with the rear and side warning system activated, the message is displayed on the display of the instrument cluster.

- When there is a foreign material on the outside and inside of the rear bumper
- When equipment such as a trailer is installed on the rear of the vehicle
- When driving on open area where no objects around road continuously (e.g., desert, meadow)
- When there is a heavy snow or a heavy rain
- When the width of the road is wide

Blind Spot Detection Warning (BSW) system

The BSW system detects a vehicle approaching the blind spot on the rear and both sides of the vehicle and informs it to the driver by turning on the outside rearview mirror warning light.

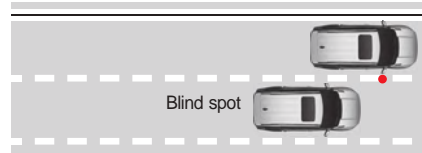

Activating / deactivating BSW system

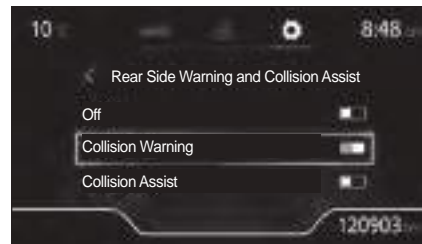

- Go to Driving Assist → Rear Side Safety Aid → Rear Side Warning and Collision Assist → Collision Warning in  (User Settings) in the instrument cluster and tick the check box.

Activation conditions

The BSW system is activated when the following conditions are met.

- When the rear and side warning system is activated
- When the vehicle speed is more than 20 km/h and less than 255 km/h
- When a vehicle is present in the blind spot detection area

Warning

- **The Blind Spot Warning (BSW) system can only give a warning in a limited area and the warning function may not operate for a vehicle approaching the rear blind spot depending on the surrounding situation and driving conditions.**

Lane Change Warning (LCW) system

The LCW (Lane Change Warning) system is designed to alert the driver by flashing the outside rearview mirror and sounding the beep when a fast approaching vehicle is detected from the rear side of the driver's vehicle.

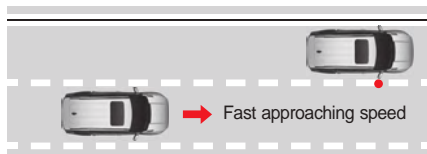

Operating conditions

The LCW system activates the warning system when the following conditions are met:

- BSW system is activated.
- Vehicle speed is between 20 km/h and 255 km/h.
- When a vehicle approaching at a high speed is in the detection area.
- Driver's vehicle is driving on a straight road.

Warning

- **This system is an aid to ensure the driver convenience. If you depend on this system, it may cause accidents. Always check the surroundings with a side mirror when changing lanes.**

BSA System

The BSA (Blind Spot-collision Assist) system is a system that, when the driver's vehicle unintentionally closes to the lane, directs the vehicle through one-sided braking to the center of the lane when a collision with the vehicle in the rear blind spot is expected, and notifies the driver by illuminating the warning light in the outside rearview mirror.

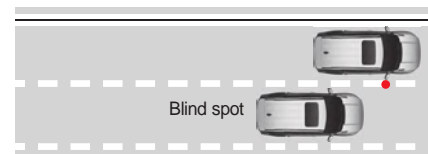

Activating / deactivating BSA system



- Go to Driving Assist → Rear Side Safety Aid → Rear Side Warning and Collision Assist → Collision Assist in  (User Settings) in the instrument cluster and tick the check box.

Operating conditions

The blind spot collision assist (BSA) system issues a warning when:

- Blind spot collision assist (BSA) is set.
- Vehicle speed is between 60km/h and 140km/h.
- Vehicle is driving on a road where both lanes are recognized normally with no brake applied. (including AEB and ACC)

BSA is deactivated when:

- Driver turns the steering wheel sharply.
- Part of vehicle has already entered the next lane.
- Brake pedal is depressed.
- The brake-related function is working (such as ACC, AEB, ESC and ABS)

Caution

- **After changing lanes, you must move to the center of the lane. The system may not work if the vehicle continues to drive close to the lane.**

Warning

- **The braking control may not work depending on the electronic stability control (ESC).**
- **When the electronic stability control (ESC) warning light comes on, the braking control does not work.**
- **When the electronic stability control (ESC) performs another function, the braking control does not work.**

RCTW System

The RCTW (Rear Cross Traffic Warning) system is a system that, when a vehicle is detected approaching from the rear left/right side during reversing the vehicle, displays a warning message in the instrument panel display window, sounds a audible alert and illuminates the warning lamp in the outside rearview mirrors to inform the driver.

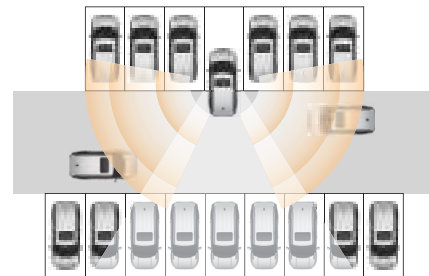

Activating / deactivating RCTW system



- Go to **Driving Assist** → **Rear Side Safety Aid** → **Rear Cross Traffic Warning and Collision Assist** → **Collision Warning** in  (User Settings) in the instrument cluster and tick the check box.

Activation conditions

- RCTW system is activated
- If the gear shift lever is placed in the R (reverse) position
- When the vehicle speed is less than 10km/h
- If a vehicle exists within the RCTW range and the speed of the approaching vehicle is 24 km/h or less

If an approaching vehicle is detected, the approach message from the relevant side is on the display of the instrument cluster.



RCTA System

The RCTA (Rear Cross Traffic-collision Assist) system is an assistive device that outputs a warning message and a buzzer to inform the driver of risk of collision due to a vehicle approaching to your side when backing up and help collision avoidance or mitigate damage by applying brake assist.

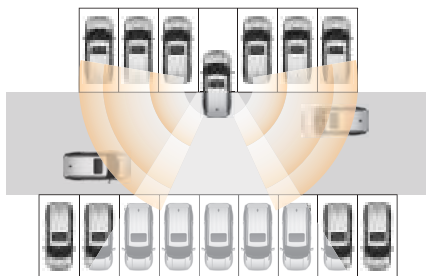

Activating / deactivating RCTA system



- Go to **Driving Assist** → **Rear Side Safety Aid** → **Rear Cross Traffic Warning and Collision Assist** → **Collision Assist** in  (User Settings) in the instrument cluster and tick the check box.

Operating conditions:

- Rear cross traffic-collision assist (RCTA) enabled
- Shift lever in R (reverse) position
- Vehicle speed of below 8 km/h
- Vehicle in warning area with approaching speed of less than 24 km/h
- If the risk of collision is detected due to an approaching vehicle during operation of the RCTA system, emergency braking (braking assist) is performed.

- The braking assist does not restart for about 10 seconds after it operates.

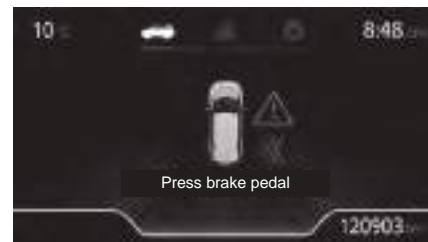

Note

- **This system may not function depending on the operation of ESC system.**
 - When ESC warning lamp light up
 - When ESC system is operating

Cases where RCTA system not work

In any of the following cases, the RCTA may not operate.

- If the target vehicle is out of the RCTA detection area
- If the target vehicle is right behind
- If the target vehicle is moving in the same direction
- If the speed of the target vehicle is fast
- If the speed of the target vehicle decreases suddenly
- If the detection sensor is covered with an obstacle

Cases where the RCTA system malfunctions

In any of the following cases, the system may malfunction, so the driver's attention is necessary.

- If the rear bumper is stained with foreign materials (rain, snow, dust, sticker, etc)
- When equipment such as a trailer is installed on the rear of the vehicle

- When the rear bumper is damaged or the vehicle body is distorted
- Sharp curve, tollgate entrance and exit section
- Tire pressure imbalance and excessive loading
- Bad (heavy snow, heavy rain) weather
- When there is a fixed object (median strips, guardrails, noise barriers) on the road or a construction section
- When a large vehicle or a small motor cycle (bicycle) is driving at a close range
- When your vehicle is passing by heavy-duty trailer
- When you accelerate the vehicle with an opposite vehicle together at the same time
- When the speed of a vehicle behind is very fast (passing)
- When you change the lane
- Steep uphill road, downhill road or a road condition where the height of lanes is different
- When an opposite vehicle is driving very closely to the rear side of the vehicle
- When a vehicle behind driving closely passes
- When the area near the sensor is covered with a vehicle, a column or a wall in the parking lot
- A vehicle that moves in the same direction when reversing the vehicle
- A small moving object such as a person, a shopping cart or a stroller

- When parking conditions are complicated (diagonal parking, near the ramp, obstacle, etc.)
- A vehicle with very low vehicle body
- A narrow road densely covered with trees or grass
- When the width of the road is very wide
- When the road surface is wet
- When the sensor detection area is changed due to a rear collision

Warning

- **The Rear Cross Traffic Warning (RCTW) system does not give a warning for an article adjacent to the vehicle and the warning function may not be activated for a vehicle approaching fast in the rear.**
- **The BSW and RCTW are assistive devices for the driver, not the safety devices. If you depend on these systems, it may cause accidents. The driver is responsible for safe driving of the vehicle by maneuvering the brake pedal. Depending on the surrounding environment and driving conditions, the warning and control functions of the system may not operate or may operate unnecessarily. Always check the surroundings while driving.**

SEW System

The SEW (Safety Exit Warning) system is an assistive device that warns the driver and passengers about the risk of an accident by displaying a warning message on the instrument panel along with a buzzer when there is a vehicle approaching from the rear side when the driver or passenger is getting off the vehicle.

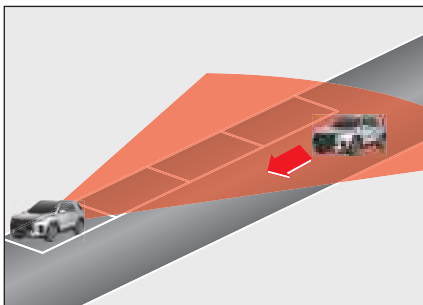

Caution

- The exit assist function operates for about 10 minutes after the ignition switch is turned off. After about 10 minutes, the exit assist function does not work to prevent battery drain.
- When you lock the door with a smart key, the exit assist function will not work immediately.

Activating / deactivating SEW system



- Go to **Driving Assist** → **Rear Side Safety Aid** → **Safety Exit Warning** in  (User Settings) in the instrument cluster and tick the check box.

Operating conditions:

- Shift lever in P (park) or N (neutral) position
- Vehicle parked
- You are about to open the door to leave the vehicle when a vehicle is approaching from the rear side

If a vehicle approaching from the rear side is detected, a warning message is displayed on the instrument panel display along with a buzzer to inform the driver and the passenger.



LDW (Lane Departure Warning)*

The LDW is a driving assist system that its Front Camera Module (FCM) detects the lanes ahead and issues a warning message and sounds the warning buzzer to help the driver to drive the vehicle while maintaining the vehicle on the line properly when the vehicle deviates from the lane with the turn signal not activated.

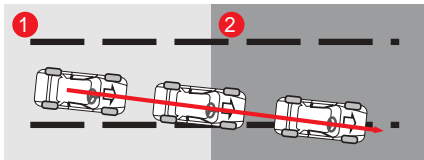

- 1 Detect the deviation of the lane with the turn signal not activated
- 2 Display a warning message and sound the warning buzzer



Warning

- The LDW prevents the lane departure, gives a warning to the driver and sounds the warning buzzer. Never depend on the lane departure warning system in any case and drive while checking the road condition.

To activate / deactivate lane departure warning (LDW)



- Go to **Driving Assist** → **Front Safety Aid** → **LDW & LKA Setting** → **Enable LDW** in  (User Settings) in the instrument cluster and tick the check box of Lane Departure Warning (LDW).

Turn the ignition switch to the "ON" position and press and hold the LKA setting button.

At this time, the lane departure warning (LDW) indicator will illuminate and LDW is activated regardless of the centering lane keeping assist (CLKA) settings.

While the lane departure warning (LDW) is activated, press and hold the button again to deactivate the function.

Notice

- Depending on the instrument cluster setting, the Lane Departure Warning (LDW) or Lane Keeping Assistance (LKA) is always in standby mode.

LDW indicator



LDW ON indicator



When the lane departure warning system is activated, the indicator on the instrument cluster turns on.

- White indicator turns on: The lane departure warning system is in ready status (the vehicle speed is below a prescribed speed or the lane is not recognized).
- Green indicator turns on: The lane departure warning system is operating normally.
- Yellow warning light turns on/blinks: When the LDW is abnormal

Activation conditions

If the following conditions are met, the LDW is activated.

- When the LDW is set
- When the vehicle speed is between 40 kph and 175 kph
- When the front camera recognizes the left and right lanes
- A straight road or gently curved road

☞ Refer to "LKA (LDW) indicator / warning lamp"
(p.4-32)

Notice

- **Entry and release conditions depending on vehicle speed**
 - **Entry conditions: 40 kph or above, 175 kph or less**
 - **Release conditions: 35 kph or less, 185 kph or above**



Warning

- **Be sure to hold the steering wheel while driving.**
- **The driver is responsible for operating the steering wheel to ensure the safe driving of the vehicle.**
- **Do not steer the vehicle rapidly when the lane departure warning system is activated.**
- **The lane departure warning system only gives a warning and sounds the warning buzzer. Therefore, the driver should keep the vehicle in the lane by steering the vehicle carefully while driving.**
- **The lane departure warning system may be deactivated, may not operate or may operate unnecessarily according to road condition and surrounding environment. Therefore, pay attention while driving.**
- **Do not attempt dangerous driving for activating the lane departure warning system.**



Caution

- Do not tint or attach a sticker or an accessory to the Front Camera Module (FCM) detection area. Doing so may cause the relevant system to malfunction or not to operate normally.
- The lane departure warning system recognizes a lane using the camera, and if the lane is not recognized properly, the system may be deactivated or may operate unnecessarily, so be careful when using the system.
- If the lane is not recognized properly, be sure to check the conditions for driver's attention.
- Do not detach any component from the LDW or apply an impact to the LDW.
- Do not place a reflecting object (white paper or mirror) on the dashboard. Doing so may cause the system to malfunction due to the reflection of light.
- The warning buzzer of the LDW may not be heard due to the loud sound from the audio system.

Cases that the system is not activated

- When the turn signal and the hazard warning lamp are operated for changing the lane
- When both the left and right lanes are not recognized
- When the vehicle is driven on one side of the lane continuously without moving to the center of the lane after changing the lane
- If the steering wheel is operated suddenly for changing the lane (the system is not activated temporarily)
- When the Electronic stability control system (ESC) is activated
- When the vehicle is circling fast on a curved road
- When the vehicle speed is less than 40 kph and more than 175 kph
- When you need to change the lane rapidly
- When the width of the lane is too narrow or too wide so that the lane cannot be detected
- When there are 2 or more lane markings on the lane while driving (example: construction section)
- If the radius of a curved road is too small

- In case of a steep sloping road
- When the vehicle speed is reduced rapidly
- When the tinted part of the windshield covers a part of the Front Camera Module (FCM) detection range



Warning

- Change the lane after operating the turn signal switch.



Caution

- Do not tint the Front Camera Module (FCM) detection area. Doing so may cause the relevant system to malfunction or not to operate.

Part prohibited for tinting (FCM detection area)



Cases requiring the driver's attention

In any of the following cases, the system may not operate or may operate unnecessarily. Therefore, the driver's attention is necessary.

- If the lanes are not visible due to foreign substances (rain, snow, dust, puddle, wet road surface)
- If the color of lane markings and the road cannot be distinguished clearly
- If the lane markings are not clear or are damaged or two or more lane markings are present on one side
- If there are markings other than or similar to the lane marking near the lane
- If the lane markings are covered in the shade of median strips, guardrails, noise barriers, other structures or roadside trees
- If there are boundary structures such as sidewalk blocks
- If the lane is crowded due to the construction section or some lanes are replaced with structures
- When the lane suddenly disappears or is invisible on the intersection
- There is a section where the number of lanes increases or decreases or the lanes intersect complicatedly (tollgate entrance, road junction/merge section, etc)
- If the lane is too narrow or too wide
- If the distance from a vehicle ahead is extremely short or a vehicle ahead is driving while hiding the lane
- There is a marking for a crosswalk or road sign on the road surface
- If the visibility is poor due to bad weather such as fog, heavy rain or heavy snow
- If the visibility is poor so that the lane cannot be recognized
- When the brightness outside the vehicle changes rapidly such as the entering a tunnel
- When the light is weak or the head light of the vehicle is not used at night or in a tunnel section
- When you drive the vehicle on the bus-only lane or on the left or right lane of the bus-only lane
- On a sharply curved section or a steeply sloping road
- when the vehicle wobbles significantly
- When a reflecting object (white paper or mirror, etc.) is placed on the dashboard
- When the windshield or the front side of the camera lens is contaminated with dust
- When the moisture formed on the glass of the windshield is not removed completely
- When the temperature near the camera is very high due to direct sunlight
- When there is backlight in the moving direction of the vehicle
- When the sunlight, streetlight or the light from an incoming vehicle is reflected by water on the road surface
- When front camera is arbitrarily refitted (Be sure to visit our authorized service center to perform the calibration of the front camera. Otherwise, it may cause the camera to malfunction.)

LKA (Lane Keeping Assistance)*

The LKA (Lane Keeping Assist) is an assistive vehicle operation technology that detects vehicles up ahead using the FCM (Front Camera Module), and when the system detects that the vehicle is departing from the current lane without a lane change indication, the vehicle visually and audibly warns the driver through the LDW (Lane Departure Warning), and if the vehicle continues to depart from the lane, the vehicle maintains stays in the current lane by taking control using the ESC system.

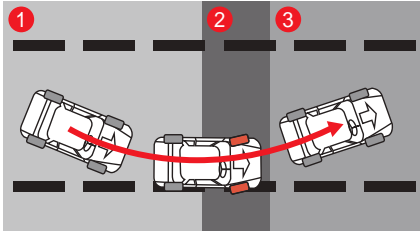

- 1 Lane departure without activation of turn signal lamp detected
- 2 Steering control by ESC as well as warning message and buzzer
- 3 The vehicle is steered toward the center of the lane.

Warning

- The LKA assists the driver with audible and visual warnings so that the vehicle does not move out of the driving lane unintentionally. Do not drive the vehicle in a dangerous or reckless manner relying on the LKA. Always drive safely paying attention to the road conditions.
- The LKA is an assistive device that precisely controls the steering wheel so that the vehicle does not leave the lane regardless of the intention of the driver.

To activate / deactivate lane keeping assistance (LKA)



- Go to **Driving Assist** → **Front Safety Aid** → **LDW & LKA Setting** → **Enable LKA** in  (User Settings) in the instrument cluster and tick the check box of Lane Keeping Assist (LKA).

Turn the ignition switch to the "ON" position and press and hold the LKA setting button.

At this time, the lane keeping assistance (LKA) indicator will illuminate and LKA is activated regardless of the entering lane keeping assist (CLKA) settings.

While the lane keeping assistance (LKA) is activated, press and hold the button again to deactivate the function.

Notice

- Depending on the instrument cluster setting, the Lane Departure Warning (LDW) or Lane Keeping Assistance (LKA) is always in standby mode.

LKA indicator

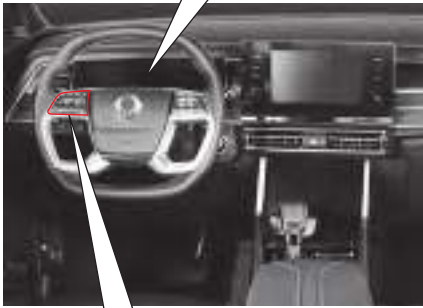

LKA ON indicator



This indicator light up on the instrument cluster when the LKA is activated.

- Indicator ON in white: System READY state (Vehicle speed below specified value or no lane detected)
- Indicator ON in green: LKA operates normally
- Indicator ON in yellow / flash: Faulty LKA system

Operating conditions

The LKA system is activated when:

- LKA is enabled
- Vehicle travels at a speed between 40 kph and 175 kph
- Front camera recognizes left/right lanes
- Driving on a straight road or gentle curve
- Turn signal is not activated

☞ Refer to "LKA (LDW) indicator / warning lamp" (p.4-32)

Notice

- Entry and release conditions depending on vehicle speed
 - Entry conditions: 40 kph or above, 175 kph or less
 - Release conditions: 35 kph or less, 180 kph or above

Warning

- Do not release your hands from the steering wheel while driving.
- The driver is responsible for safe driving of the vehicle by maneuvering the steering wheel.
- Do not steer the vehicle rapidly while the LKA is activated.
- The LKA does not always control the steering wheel automatically.



Warning

- The LKA is only a device to assist with the steering wheel operation, and the driver is entirely responsible for maintaining the lane with the steering wheel operation.
- The LKA may be deactivated, not work at all, or activated when it is not desired depending on the road conditions and surrounding environment.
- Never drive the vehicle in a dangerous or reckless manner to test the LKA.
- When replacing the steering wheel system-relevant parts, have the system checked and serviced at a KG Mobility Dealer or KG Mobility Authorized Service Center.



Caution

- Do not attach sticker, accessory, tinting films on the detection area of the FCM. This can cause malfunctions and abnormal operation of the related systems.
- The LDW recognizes the lanes by using the images from the cameras. Keep in mind that the LDW may be deactivated or activated when it is not desired if the lanes are not recognized successfully.
- Pay close attention especially when the LKA fails to detect the lane markings.



Caution

- Do not remove any part of the LDW or apply impact on it.
- Do not put any object with reflective surface (white paper, mirror, etc.) on the instrument panel. Reflected lights can cause system malfunction.
- You may not hear the audible alert (chime) if the sound from your audio source is too loud.
- If you drive without holding the steering wheel for too long, LKA will be turned off automatically after the hands off alert.
- Please note that when driving at high speed, the steering assist force of the lane keeping assist system may be reduced, which can cause the vehicle to leave the lane.
- The driver is responsible for operating the steering wheel.
- The driver can still steer the vehicle in the event of the faulty LKA.
- Please operate the steering wheel by hand without using the LKA when:
 - Weather is bad
 - Road condition is not good
 - Frequent steering wheel control is required
- You may feel that the steering wheel is heavy or light when the LKA is not operating.

Cases that the system is not activated

- When the turn signal and the hazard warning lamp are operated for changing the lane
- When both the left and right lanes are not recognized
- When the vehicle is driven on one side of the lane continuously without moving to the center of the lane after changing the lane
- If the steering wheel is operated suddenly for changing the lane (the system is not activated temporarily)
- When the Electronic stability control system (ESC) is activated
- When the vehicle is circling fast on a curved road
- When the vehicle speed is less than 40 kph and more than 180 kph
- When you need to change the lane rapidly
- When the width of the lane is too narrow or too wide so that the lane cannot be detected
- When there are 2 or more lane markings on the lane while driving (example: construction section)
- If the radius of a curved road is too small
- In case of a steep sloping road
- When the vehicle speed is reduced rapidly
- When the tinted part of the windshield covers a part of the Front Camera Module (FCM) detection range

Warning

- Change the lane after operating the turn signal switch.

Caution

- Do not tint the Front Camera Module (FCM) detection area. Doing so may cause the relevant system to malfunction or not to operate.

Part prohibited for tinting (FCM detection area)

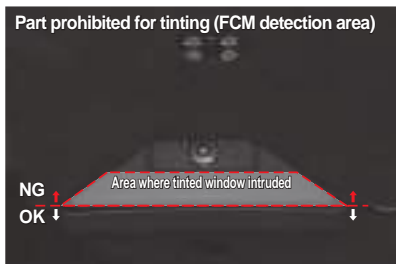

Cases requiring the driver's attention

In any of the following cases, the system may not operate or may operate unnecessarily. Therefore, the driver's attention is necessary.

- If the lanes are not visible due to foreign substances (rain, snow, dust, puddle, wet road surface)

- If the color of lane markings and the road cannot be distinguished clearly
- If the lane markings are not clear or are damaged or two or more lane markings are present on one side
- If there are markings other than or similar to the lane marking near the lane
- If the lane markings are covered in the shade of median strips, guardrails, noise barriers, other structures or roadside trees
- If there are boundary structures such as sidewalk blocks
- If the lane is crowded due to the construction section or some lanes are replaced with structures
- When the lane suddenly disappears or is invisible on the intersection
- There is a section where the number of lanes increases or decreases or the lanes intersect complicatedly (tollgate entrance, road junction/merge section, etc)
- If the lane is too narrow or too wide
- If the distance from a vehicle ahead is extremely short or a vehicle ahead is driving while hiding the lane
- There is a marking for a crosswalk or road sign on the road surface
- If the visibility is poor due to bad weather such as fog, heavy rain or heavy snow
- If the visibility is poor so that the lane cannot be recognized
- When the brightness outside the vehicle changes rapidly such as the entering a tunnel
- When the light is weak or the head light of the vehicle is not used at night or in a tunnel section
- When you drive the vehicle on the bus-only lane or on the left or right lane of the bus-only lane
- On a sharply curved section or a steeply sloping road
- when the vehicle wobbles significantly
- When a reflecting object (white paper or mirror, etc.) is placed on the dashboard
- When the windshield or the front side of the camera lens is contaminated with dust
- When the moisture formed on the glass of the windshield is not removed completely
- When the temperature near the camera is very high due to direct sunlight
- When there is backlight in the moving direction of the vehicle
- When the sunlight, streetlight or the light from an incoming vehicle is reflected by water on the road surface
- When front camera is arbitrarily refitted (Be sure to visit our authorized service center to perform the calibration of the front camera. Otherwise, it may cause the camera to malfunction.)

ELK (Emergency Lane Keeping)*

RKA-ROADEDGE (Lane Keeping Assist-Roadedge)

The RKA-ROADEDGE (Lane Keeping Assist-Roadedge) is a driving assistance system that helps the driver's vehicle maintain a Road-edge through the steering wheel (EPS) control if the front camera module (FCM) recognizes the left and right roads in front and the driver's vehicle departs the Road-edge without using a turn signal in that direction.

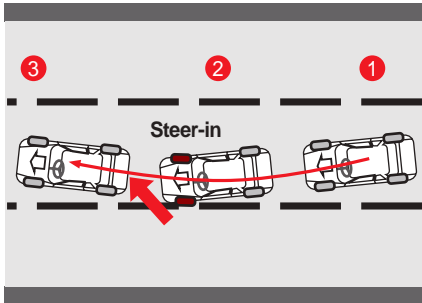

- 1 Road-edge departure detected with no turn signal operated
- 2 EPS steering control
- 3 Vehicle enters middle of driving road

Warning

- RKA-ROADEDGE is an assist system to precisely control the steering wheel so that the driver's vehicle does not leave the Road-edge, regardless of the driver's intention.

Activation / Deactivation

To activate ELK : Turn the ignition switch on.

To deactivate ELK : Please untick "ELK" in the User Settings on the instrument cluster.

Operating conditions

The RKA-Roadedge system is activated when:

- Vehicle travels at a speed between 60 km/h and 175 km/h
- Front camera recognizes left/right Road-edge
- Driving on a straight road or gentle curve
- Turn signal is not activated

Warning

- Do not release your hands from the steering wheel while driving.
- The driver is responsible for safe driving of the vehicle by maneuvering the steering wheel.
- The RKA-Roadedge does not always control the steering wheel automatically.

Warning

- The RKA-Roadedge may be deactivated, not work at all, or activated when it is not desired depending on the road conditions and surrounding environment.
- Never drive the vehicle in a dangerous or reckless manner to test the RKA-Roadedge.
- When replacing the steering wheel system-relevant parts, have the system checked and serviced at a KG Mobility Dealer or KG Mobility Authorized Service Center.

! Caution

- Do not attach sticker, accessory, tinting films on the detection area of the FCM. This can cause malfunctions and abnormal operation of the related systems.
- The RKA-Roadedge recognizes the Road-edge by using the images from the cameras. Keep in mind that the RKA-Roadedge may be deactivated or activated when it is not desired if the Road-edge are not recognized successfully.

! Caution

- Do not remove any part of the RKA-Roadedge or apply impact on it.
- Do not put any object with reflective surface (white paper, mirror, etc.) on the instrument panel. Reflected lights can cause system malfunction.
- Please note that when driving at high speed, the steering assist force of the RKA-Roadedge may be reduced, which can cause the vehicle to leave the Road-edge.

Does not work when:

- The driver activates the turn signal lamps or hazard warning lamp.
- The vehicle keeps being driven too close to any side of the lane after changing the lane.
- The driver changes the lane with abrupt steering wheel operation. (temporarily system inactivated)
- ESP (Electronic Stability Program) system is activated.
- The vehicle is cornering at high speed.
- Vehicle speed is below 55 km/h or above 180 km/h
- The driver changes the lane abruptly.
- The lane is too narrow or too wide to recognize it.
- The vehicle is driven around a curve with too small radius.
- The vehicle is driven on steep hills.
- The vehicle decelerates abruptly.
- The windshield tinting film covers the detection range of the front camera module (FCM).

! Warning

- Activate the turn signal lamps before trying to make a lane-change.

! Caution

- Do not apply tinting film on the FCM detection area. This may cause the related system to malfunction or not work.

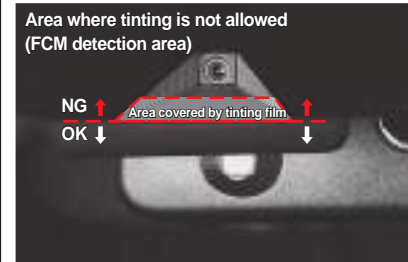

Driver Attention Required

The RKA-ROAEDGE may not work at all or be activated when it is not desired in the following conditions:

- The system cannot recognize the Road-edge markings because of rain, snow, dust, standing water or puddles, other obstruction on the road.
- The color of the Road-edge markings is not clearly distinct from the road color.
- The Road-edge markings are not clear.
- The Road-edge markings are covered in shadows of the median barriers, guardrails, noise barrier walls, roadside trees.
- There are environmental barriers, such as bollard.
- The Road-edge markings are suddenly discontinued at roundabouts and road intersections.
- The vehicle is passing through a certain section, such as highway interchange, where the number of lanes increases or decreases.
- The distance to the vehicle ahead is too short or a wheel of the vehicle ahead is touching the Road-edge marker.
- Poor visibility due to factors such as fog, heavy rain, heavy snow, etc.
- There is rapid change of illumination, for example at tunnel entry and exit points
- The headlamps are not turned on or the brightness of the lamps is too low when driving at night or through tunnels.
- The vehicle is driven on a steep hill or around sharp corners.
- The vehicle is driven under specific conditions which cause severe vibration.
- Objects with reflective surface (white paper, mirror, etc.) are on the dashboard.
- The windshield glass in front of the camera module is covered with ice, snow, slush, mud, dirt or debris.
- Fog or mist on the windshield.
- The temperature around the front view camera is too high because of the direct sunlight.
- The vehicle is moving towards a light source.
- The light from the sun, streetlamps, or headlamps of oncoming vehicles is reflected by the wet road surface.

Centering Lane Keeping Assist (CLKA)

The centering lane keeping assist is a driving aid that, once the front camera module (FCM) recognizes the lane ahead, helps the driver's vehicle stay on the road-edge through steering wheel (EPS) control.

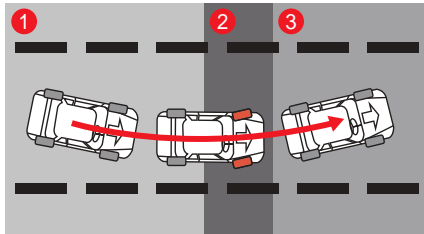

- 1 Vehicle leaving center of lane detected
- 2 Steering control by EPS as well as warning message and buzzer
- 3 Controls vehicle to move to center of lane

Notice

- To operate the centering lane keeping assist (CLKA), the driver must always press the LKA setting button briefly after turning the ignition switch to the ON position.

Warning

- The centering lane keeping assist (CLKA) is the system that provides a visual and audible warning to the driver to keep the driver's vehicle between lanes (center). Do not drive the vehicle in a dangerous or reckless manner relying on the CLKA. Always drive safely paying attention to the road conditions.
- The CLKA is an assistive device that precisely controls the steering wheel so that the vehicle does not get out of the middle of the lane regardless of the driver's intention.

To activate / deactivate CLKA

Turn the ignition switch to the "ON" position and press the LKA setting button briefly.

At this time, the centering lane keeping assist (CLKA) indicator will illuminate and CLKA is activated regardless of the lane departure warning (LDW) and lane keeping assistance (LKA) settings.

While the CLKA is activated, press the button briefly again to deactivate the function.

Centering lane keeping assist (CLKA) indicator



Centering lane keeping assist (CLKA) ON indicator lamp



- When the centering lane keeping assist (CLKA) is activated, the indicator illuminates on the instrument cluster.
- Indicator ON in white: CLKA standby mode (Vehicle speed below specified value or no lane detected)
- Indicator ON in green: CLKA normal operation
- Indicator ON in yellow / flash: In the event of faulty CLKA

Notice

- **For safe operation, turning the ignition switch to the OFF position cancels the setting of the centering lane keeping assist (CLKA). Press the button briefly to operate the CLKA.**
- **If intelligent cruise control (IACC) is activated during CLKA operation, CLKA will be disabled. If IACC is subsequently disabled, CLKA is automatically reactivated.**

Conditions for activation

CLKA will be activated when:

- LKA setting button is pressed briefly.
 - Vehicle speed is 180 km/h or lower.
 - Front camera recognizes left/right lanes.
 - The vehicle is driving on a straight road or gentle curve.
 - Turn signal is not activated.
 - Turn signal on the opposite side of direction in which you are about to move is operated.
- ☞ Refer to “Centering lane keeping assist (CLKA) indicator / warning lamp” (p.4-33)



Warning

- **Do not release your hands from the steering wheel while driving.**
- **The driver is responsible for safe driving of the vehicle by maneuvering the steering wheel.**
- **Do not steer the vehicle unnecessarily rapidly while the CLKA is activated.**
- **The CLKA does not always provide the steering wheel control automatically.**
- **The CLKA is only a device to assist with the steering wheel operation, and the driver is entirely responsible for maintaining the lane with the steering wheel operation.**
- **The CLKA may be deactivated, not work at all, or activated when it is not desired depending on the road conditions and surrounding environment.**
- **Do not try to drive the vehicle in a dangerous or reckless manner to see how the CLKA is operated.**
- **When replacing the steering wheel system-relevant parts, have the system checked and serviced at a KG Mobility Dealer or KG Mobility Authorized Service Center.**



Caution

- Do not attach sticker, accessory, tinting films on the detection area of the FCM. This can cause malfunctions and abnormal operation of the related systems.
- The CLKA recognizes the lanes by using the images from the cameras. Keep in mind that the CLKA may be deactivated or perform unnecessary operations if the lanes are not recognized successfully.
- Pay close attention especially when the LKAS fails to detect the lane markings.
- Do not remove any part of the CLKA arbitrarily or apply impact on it.
- Do not put any object with reflective surface (white paper, mirror, etc.) on the instrument panel. Reflected lights can cause system malfunction.
- You may not hear the audible alert (chime) from CLKA if the sound from your audio source is too loud.
- If you drive without holding the steering wheel for too long, CLKA will be disabled automatically after the hands off alert.



Caution

- Please note that when driving at high speed, the steering assist force of the CLKA may be reduced, which can cause the vehicle to leave the lane.
- The driver is responsible for operating the steering wheel.
- The driver can still steer the vehicle in the event of the faulty CLKA.
- Please operate the steering wheel by hand without using the CLKA when:
 - Weather is bad
 - Road condition is not good
 - Frequent steering wheel control is required
- You may feel that the steering wheel is heavy or light under conditions in which CLKA does not assist steering wheel operation.

The CLKA does not work when:

- The driver activates the turn signal lamps or hazard warning lamp.
- Both lanes are not detected.
- The vehicle keeps being driven too close to any side of the lane after changing the lane.
- The driver changes the lane with abrupt steering wheel operation. (temporarily system inactivated)
- Electronic stability control (ESC) is activated.
- The vehicle is cornering at high speed.
- Vehicle speed is below 40km/h or above 180 km/h
- The driver changes the lane abruptly.
- The lane is too narrow or too wide to recognize it.
- There are 2 or more lane markings (e.g. construction zone).
- The vehicle is driven around a curve with too small radius.
- The vehicle is driven on steep hills.
- The vehicle decelerates abruptly.
- The windshield tinting film covers the detection range of the front camera module (FCM).



Warning

- **Activate the turn signal lamps before trying to make a lane-change.**



Caution

- **Do not apply tinting film on the FCM detection area. This may cause the related system to malfunction or not work.**

Area where tinting is not allowed (FCM detection area)

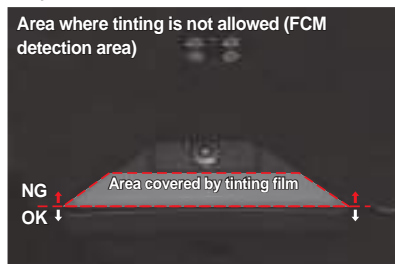

Driver Attention Required

The CLKA may not work at all or be activated when it is not desired in the following conditions:

- The system cannot recognize the lane markings because of rain, snow, dust, standing water or puddles, other obstruction on the road.
- The color of the lane markings is not clearly distinct from the road color.
- The lane markings are not clear or tampered by the traffic, or there are 2 or more lane markings on one side.
- There are other markings similar to the lane markings on the roads.
- The lane markings are covered in shadows of the median barriers, guardrails, noise barrier walls, roadside trees.
- There are environmental barriers, such as bollard.
- The traffic is heavy due to the construction in the area or traffic control items, such as traffic cones, are used to separate traffic flows.
- The lane markings are suddenly discontinued at roundabouts and road intersections.
- The vehicle is passing through a certain section, such as highway interchange, where the number of lanes increases or decreases.
- The width of the driving lane is too narrow or wide.
- The distance to the vehicle ahead is too short or a wheel of the vehicle ahead is touching the lane marker.
- There are other roadway markings on the roads, such as crosswalk markings, arrows, symbols, along with the lane markings.
- Poor visibility due to factors such as fog, heavy rain, heavy snow, etc.
- Hard to recognize other vehicles and pedestrians because of poor visibility.
- There is rapid change of illumination, for example at tunnel entry and exit points
- The headlamps are not turned on or the brightness of the lamps is too low when driving at night or through tunnels.

- When you are traveling within or near the outer edges of the bus-only lane.
- The vehicle is driven on a steep hill or around sharp corners.
- the vehicle is driven under specific conditions which cause severe vibration.
- Objects with reflective surface (white paper, mirror, etc.) are on the dashboard.
- The windshield glass in front of the camera module is covered with ice, snow, slush, mud, dirt or debris.
- Fog or mist on the windshield.
- The temperature around the front view camera is too high because of the direct sunlight.
- The vehicle is moving towards a light source.
- The light from the sun, streetlamps, or headlamps of oncoming vehicles is reflected by the wet road surface.
- When front camera is arbitrarily refitted (Be sure to visit our authorized service center to perform the calibration of the front camera. Otherwise, it may cause the camera to malfunction.)

FVSW (Front Vehicle Start Warning)*

It is a system that notifies the driver when the driver does not recognize that the ahead vehicle departed while the driver's vehicle is stationary, using the sensor (FCM) at front of the vehicle.

FVSW : Front Vehicle Start Warning

How To Set



You can enable (check) or disable (uncheck) this feature under the instrument cluster main menu, "User Settings → Driving Assist → Front Safety Aid → Front Vehicle Start Warning" with the vehicle turned on.

Operation



If the driver does not perform any operation (such as not starting the vehicle) about 1 second after the ahead vehicle departs, the message will be displayed on the LCD and alarm will sound.

Caution

- For safe driving, be sure to check the front and surrounding road conditions before starting the vehicle.
- The FVSW (Front Vehicle Start Warning) does not work in stop situations other than stop by the brake pedal, auto hold, or smart cruise control system.
- If you stop the vehicle with shift lever in N (neutral) position, it may not operate or may generate a false alarm.
- In an environment other than the normal driving situation (non-motorway / highway), it may generate a false alarm.
- The FVSW works only when the shift lever is in D (drive) or N (neutral) position.
- There may be a false alarm if you stop at a speed bump or ramp.

Parking assist system*

Front/rear obstacle detection system

The front/rear obstacle detection system is a parking assist system that detects an obstacle through the ultrasonic sensor installed on the bumper and informs the driver with a warning buzzer when the driver places the gear shift lever in the D (driving) or the R (reverse) position and drives the vehicle.



Activating the obstacle detection system

D (driving) position	4 obstacle detection sensors
	

If the transmission selector lever is in the D (drive) position, the detection sensor operates when:

- Vehicle starts to move after initial start (at vehicle speed of 15 km/h or lower).
- Transmission selector lever is changed from R (reverse) position to D (drive) position (at vehicle speed of 15 km/h or lower).
- Front obstacle detection warning switch is turned on (at vehicle speed of 15 km/h or lower).

However, it will remain off after the vehicle speed exceeds 15 km/h.

R (reverse) position	6 obstacle detection sensors
	



When the gear shift lever is placed in the R (reverse) position, 2 front obstacle detection sensors and 4 rear obstacle detection sensors are activated at the same time.

Notice
<ul style="list-style-type: none"> • Even if the front parking assist warning ON/OFF switch in the OFF position (indicator off), the front obstacle detection sensor operates when reversing the vehicle. • An alarm may sound intermittently in the event of rain and this is not a malfunction but normal operation.

Indication on the display of the instrument cluster

When an obstacle is detected, the relevant edge indicating the detection distance and direction blinks.



Display of the instrument cluster	
D (driving) position	R (reverse) position
	

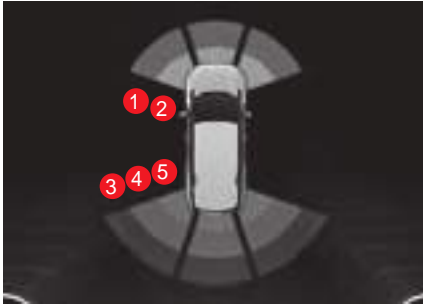

When no obstacle is detected



The range of front and rear sensors is displayed and blinks (no warning buzzer)

If an obstacle is detected from 40 cm at the front left side or the front right side



Line No. ① at the front left side is deleted and Line No. ② blinks (Warning buzzer sounds)

If an obstacle is detected from 80 cm at the rear left side, front side or right side



Line No. ③ at the rear right side is deleted and Line No. ④ blinks (Warning buzzer sounds)

Warning buzzer interval

The warning buzzer sounds as follows depending on the distance from the obstacle.

Front obstacle detection sensor (level 2 warning buzzer)



Warning buzzer interval	Distance from the obstacle	
	Center	Side
No warning buzzer	100 cm	60 cm
① 0.15 second	50 cm ~ 100 cm	40 cm ~ 60 cm
② Continuous	25 cm ~ 50 cm	25 cm ~ 40 cm

Rear obstacle detection sensor (Level 3 warning buzzer)

Warning buzzer interval	Distance from the obstacle	
	Center	Side
③ 0.3 second	80 cm ~ 120 cm	-
④ 0.15 second	50 cm ~ 80 cm	-
⑤ Continuous	25 cm ~ 50 cm	-

Sensor and relevant system malfunction



Display of the instrument cluster	
D (driving) position	R (reverse) position
	

When the obstacle detection sensor is abnormal, “?” is displayed for the relevant sensor. If this message is display on the display of the instrument cluster, have your vehicle checked and serviced at a nearby KG Mobility Authorized Service Center.



Caution

- If the distance between the sensor and the obstacle is 25 cm or less, the warning buzzer does not sound. However, if the obstacle is recognized clearly, the warning buzzer may sound.
- When the warning buzzer sounds, the distance from the obstacle may be different from the actual distance by approximately ± 10 cm.
- Do not rely too much on the parking assist system and reverse the vehicle while checking the rear side.
- If an abnormal warning buzzer whose duration is different from a warning buzzer that occurs due to the detection of an obstacle or a long warning buzzer for 3 seconds occur when the gear shift lever is placed in the R (reverse) position, the obstacle detection system or the detection sensor is abnormal. Have your vehicle checked.

If the system does not operate or malfunctions

If there is an object that cannot be detected by the sensor

- A thin object such as steel wire, rope or chain
- An object such as cotton, sponge, fiber or snow that absorbs sound waves
- An object that is located lower than the bumper (example : drainage or puddle)

The sensor cannot detect

- when the sensor is frozen (the normal function is restored after thawed.)
- When sensor is clogged by foreign materials such as snow, mud or water drops (the normal function is restored after removed)

When the sensor detection range becomes narrower

- The sensor is partially covered with snow or mud so that the signal detection area becomes narrower (the normal function is restored after removal)
- When the temperature near the sensor is extremely high or low

Cases that may cause malfunction although it is not a system failure

- Driving the vehicle on bumpy roads, gravel roads, hillside road, or grass
- When the height of the bumper is lowered due to heavy load
- When other ultrasound waves are received (metallic sound, air brake sound of a large vehicle, etc)
- When a high-power radio set is used
- When there is a heavy rain
- When an accessory is attached to or near the area where the sensor is installed

When towing a trailer

- The sensor may detect the trailer, sounding the warning buzzer continuously.

Cautions regarding the front/rear obstacle detection system



Caution

- When parking or reversing the vehicle, check if there is any person, animal or especially a child around. If you cannot check it properly, be sure to get out of the vehicle and check.
- The parking assist system is only a system for the user's convenience and this system does not guarantee safety. The driver should pay attention to all possible conditions.
- When you strongly press or apply an impact to the sensor part on the bumper or strong water pressure is applied during car wash, the sensor may be damaged.
- When the system is normal and the gear shift lever is placed in the R (reverse) position with the START/STOP switch in the ON status, a beep sounds once briefly.
- If an abnormal warning buzzer whose duration is different from a warning buzzer that occurs due to the detection of an obstacle or a long warning buzzer for 3 seconds occur when the gear shift lever is placed in the R (reverse) position, the obstacle detection system or the detection sensor is abnormal. Have your vehicle checked.

- In the parking space shown in the figure below, the upper portion of the vehicle may collide before the detection sensor at the bottom operates. Park the vehicle while checking through the outside rearview mirror or turning your head directly.



Rear camera system

The rear camera system is an auxiliary safety system that allows the driver to view the situation behind the vehicle through the rear camera using the monitor when the gear shift lever is placed in the R (reverse) position.

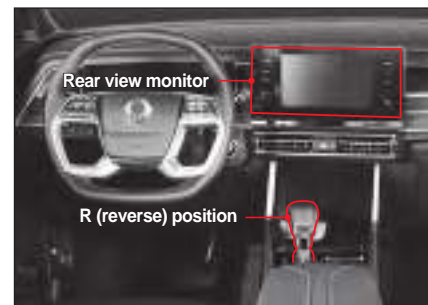

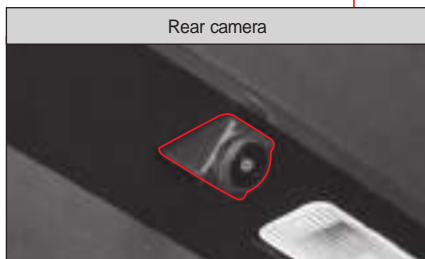
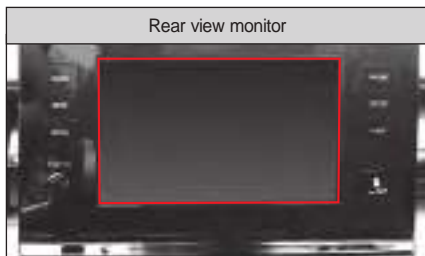

 **Caution**

- The rear camera uses a wide-angle lens to secure a wide view, so the actual distance is different from what you see through the monitor. Be sure to check the rear, left and right view directly.
- The screen shown on the monitor is a part of, not the whole background view of the vehicle.
- Clean the rear camera lens frequently using a camera lens cleaner to prevent it from being contaminated.

 **Warning**

- The rear camera screen does not work during software update. Always stop the vehicle to update the software and do not drive the vehicle until the update is completed.
- Be careful when reversing since the rear obstacle may be hidden by the warning messages and parking guide lines if the rear camera system is activated.

Double parking (2-row parking)

Vehicles With EPB

Since double parking (2-row parking) is required due to insufficient parking space, operate as follows.

- 1 With the START/STOP switch in the ON status or while the engine is running, release the Electronic Parking Brake (EPB).



Notice

- If the AUTO HOLD function is activated, the EPB is activated automatically. Be sure to deactivate the function by pressing the AUTO HOLD switch before carrying out the process.

- 2 Depress the brake pedal, place the gear shift lever in the P (parking) position and turn off the engine.



Notice

- When the gear shift lever is placed in a position other than the P (parking) position, the engine cannot be turned off.

- 3 Depress the brake pedal, press the unlock button and move the gear shift lever to the N (neutral) position. (Press the knob button when moving the shift lever.)



Warning

- Be sure to carry out double parking (2-row parking) on completely flat ground and take a separate measure such as placing a chock on the wheels. Failure to do so may cause the vehicle to move, that is very dangerous.

5. Emergency Measures in the Event of Emergency

You can check useful information and emergency measures for various emergency situations you can face while driving.

Information regarding the warning triangle and OVM tools, the correct procedure in case of a dead battery, engine overheating, flat tire, and towing a vehicle is provided. An explanation is also provided for how to respond to a fire, heavy snow, vehicle trouble, and an accident safely.

Warning triangle and OVM (Owner Vehicle Maintenance) tools

Warning triangle

A warning triangle is a stop sign that should be placed in the rear side of the vehicle in order to prevent any secondary accidents in the event of emergency such as car trouble or the occurrence of an accident.

Carrying and placement of a warning triangle is mandatory by the Road Traffic Act. A fine is imposed if you violate it.

Storage place of the warning triangle*

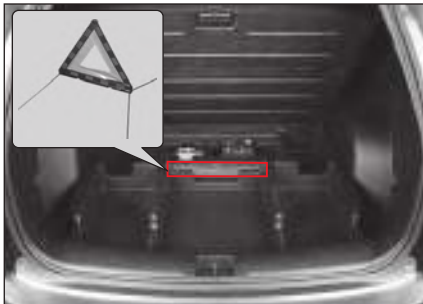

The warning triangle is stored at the bottom of the luggage board.

Caution

- The KS standard automotive warning triangle (sign of broken down vehicle) should be stored in the vehicle according to the Road Traffic Act. Failure to do so is subject to a fine.
- While paying particular attention to surrounding traffic conditions, place the warning triangle in a position where its reflecting plate can be clearly visible to vehicles approaching from the rear.
- Place a road flare in addition to the warning triangle at night.
- If your vehicle becomes operational again or the problem is fixed, move the vehicle promptly while paying particular attention to the traffic conditions.

OVM tools

The OVM tools are apparatuses or tools stored in the vehicle in preparation for a failure or an emergency situation that can occur while driving the vehicle.

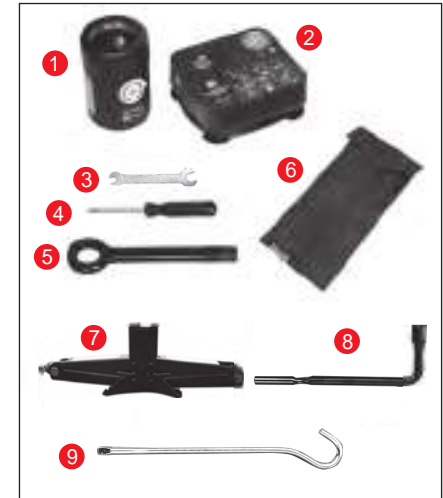

- 1 Sealant (Emergency sealing compound in case of a flat tire)
- 2 Compressor (managing the tire pressure and injecting sealant in case of a flat tire)
- 3 Spanner
- 4 Screwdriver (+ and -)
- 5 Vehicle towing hook
- 6 Tool roll pouch
- 7 Jack
- 8 Wheel nut wrench
- 9 Jack connection

- Service kit: 1, 2, 3, 4, 5, 6
- Spare tire: 3, 4, 5, 6, 7, 8, 9
- Non spare tire: 3, 4, 5, 6

※ CE, UKCA certified parts: Compressor (2),
Jack (7)

(1) CE

- Representative: KG Mobility European Parts Center B.V.
- Address: IABC 5253&5254, 4814RD Breda, The Netherlands

(2) UKCA

- Importer: KG Mobility UK Ltd
- Address: G Offices, Parsonage Road, Stratton St. Margaret, Swindon, Wiltshire SN3 4RN

Location where the OVM tools are stored

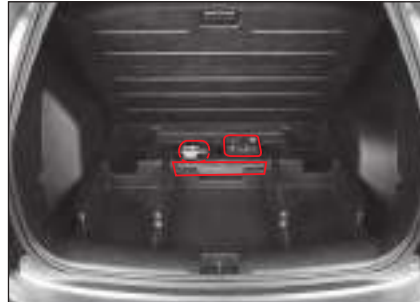

The OVM tools are stored in the storage box at the rear left side of the luggage compartment.
Take out and use the OVM tools any time when necessary.

When the engine cannot be started due to depletion of the battery

If the engine cannot be started due to depletion of the battery, you can start the engine by connecting a battery of the same standard and capacity from another vehicle or an auxiliary battery to your battery using the jump cable.

Starting the engine using the jump cable

Move another vehicle that has the same 12 V power or an auxiliary battery closely to the depleted battery that can be reached by the jump cable and start the engine according to the following order.

- 1 Switch off all electrical accessories of the depleted vehicle.
- 2 Place the gear shift lever of the depleted vehicle in the P (parking) position and apply the parking brake.
- 3 Connect the jump cable in the following order.
 - + terminal (1) of the depleted battery
 - + terminal (2) of the battery in another vehicle or an auxiliary battery that provides power supply
 - - terminal (3) of the battery in another vehicle or an auxiliary battery that provides power supply
 - Vehicle body of the depleted vehicle (4) (a location far from the battery)

- 4 If the battery of another vehicle is used, start the engine of the relevant vehicle and idle the engine for several minutes.
- 5 Start the engine of the depleted vehicle.

- 6 When the engine is started, separate the jump cable in the following order.
 - Jump cable connected to the minus (-) terminal
 - Jump cable connected to the positive (+) terminal

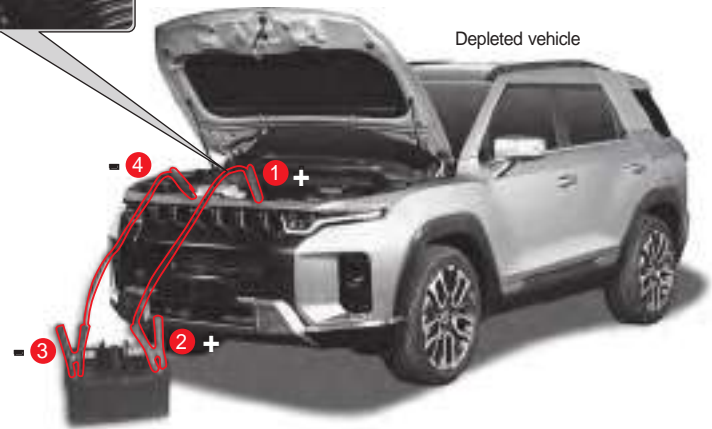
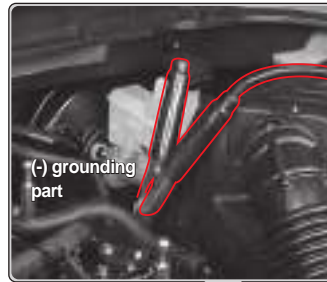



Warning

- Follow the procedure to start the engine using the jump cable explained in this owner's manual. Failure to do so may cause an injury or damage the vehicle due to a battery explosion.
- If the battery is frozen, do not attempt to start the engine using the jump cable. Doing so may lead the battery to burst or explode, causing serious injury.
- Be sure to wear insulated gloves for starting the engine using the jump cable to prevent an electric shock.
- Make sure that two vehicles do not come into contact with each other. Failure to do so may result in ground connection status, causing an electric shock and a vehicle failure.
- Be sure to use the jump cable of the specified standard and a battery of the same standard and capacity. Failure to do so may cause a spark when the jump cables are connected and gas generated from the battery may explode.
- When using the battery of another vehicle, connect the jump cable with the engine of the other vehicle turned off for safety.

- When connecting the jump cables, make sure that the positive (+) and negative (-) cables do not come into contact with each other. Otherwise, an electric spark may occur, resulting in the explosion of the battery.
- Do not connect the jump cable to the negative (-) terminal of the depleted battery directly. Otherwise, an electric spark may occur, resulting in the explosion of the battery. Be sure to connect the jump cable to the vehicle body of the depleted vehicle.
- Make sure that the jump cables are securely fixed to each terminal. Failure to do so may cause disconnection due to an instantaneous vibration when the engine is started. If the jump cable is separated and comes into contact with the vehicle body, an electric shock may be applied to the vehicle, damaging electric and electronic components.
- The battery fluid is very acidic, so if it comes into contact with your eyes or on your skin, take off the clothes that are stained with the battery fluid immediately, rinse the contacted area with clean water continuously and contact your doctor. While being transported to a hospital, gently wipe the contacted area with a water-wet soft cloth or sponge continuously.



Caution

- Make sure when starting the engine that the jump cable is not wound around the fan in the engine room.
- After starting the engine using the jump cable, do not turn off the engine for a certain period of time to allow the depleted battery to be recharged. Otherwise, you may not be able to start the engine again according to the charging status of the battery.
- If the cause of the depleted battery is not clear, have your vehicle checked at a KG Mobility Authorized Service Center.

When the engine is overheated or other problems have occurred

When the engine is overheated so that the warning light turns on



When the engine is overheated, various symptoms appear such as the warning light turns on and steam comes out from the engine.

In such case, park your vehicle at a safe place immediately and take the necessary action.



Symptoms that appear when the engine is overheated

- The engine overheat warning lamp blinks and the warning buzzer sounds.
- The coolant temperature gauge indicates the H part.
- Steam comes out from the engine.
- A decrease in the engine output

Emergency measures when the engine is overheated

Place the warning triangle at the rear side of the vehicle, evacuate all occupants to a safe place, check for safety again if necessary and take emergency measures according to the following procedure.

- 1 Place the gear shift lever in the P (parking) position and apply the parking brake.
- 2 Turn off the heater and the air conditioner.
- 3 Open the engine hood so that the engine room can be well ventilated.

At this time, if steam comes out of the engine, turn off the engine immediately.

If steam does not come out, idle the engine continuously with the engine hood opened.

If the coolant temperature gauge does not go down while the engine is idling, turn off the engine and let it cool down properly.

- 4 Check the coolant level on the coolant reservoir.
If the coolant level is low, add coolant and check if a leak occurs from the connecting part of each hose and the radiator.
Cover the reservoir cap with a cloth, turn it a little bit to release steam pressure, remove the cap and add the coolant. Close the reservoir cap after adding the coolant.

If the engine is overheated when the coolant level is normal, have the cooling systems (including the electric fan) and belts checked and serviced at a KG Mobility Authorized Service Center.

Warning

- **Caution should be taken that hot steam or coolant may come out when you open the engine hood.**
- **Be careful not to allow your clothes or hands to come into contact with the driving parts (belts, etc.) of the engine when you open the engine hood while the engine is running.**
- **Do not open the coolant reservoir cap rapidly when the engine is hot. Hot steam or water may come out, causing a burn. Be sure to open the coolant reservoir cap slowly after the engine is turned off and the engine has been cooled down properly.**



Caution

- If the engine is overheated with insufficient coolant, turn off the engine immediately, cool down the engine and add coolant.
- Do not add cold coolant suddenly when the engine is overheated. Doing so may damage the engine or the radiator.
- Only use the KG Mobility genuine coolant that meets the standard.
- If the engine is overheated continuously after taking the emergency measures, have your vehicle checked and serviced at a KG Mobility Authorized Service Center.

When the engine check indicator turns on

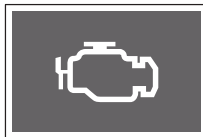

The engine check indicator turns on when various sensors (including automatic transmission) and equipment related to the engine control are abnormal.

If the engine check indicator turns on while driving, have your vehicle checked and serviced at a KG Mobility Authorized Service Center.



Caution

- If the engine check indicator turns on, the driving power of the engine may decrease or the engine may stall.

When a tire is flat



If a tire becomes flat while driving, do not panic and take action according to the following order.

- 1 Turn on the hazard warning lamp indicator.
- 2 Stop the vehicle at a safe place.
For such purpose, hold the steering wheel firmly, take your foot off the accelerator pedal, decelerate the vehicle slowly and depress the brake pedal slightly to stop the vehicle safely.
- 3 Place the gear shift lever in the P (parking) position and apply the parking brake.
- 4 Place a chock in front of and at the back of the tires located in the diagonal direction of the flat tire.

- 5 Be sure to place the warning triangle on a road or an expressway where other vehicles are driving.

The position that is easily identified by a driver in an approaching vehicle while maintaining a safe distance (100 m during daytime, 200 m in the rear during night time) is an appropriate place to place the warning triangle.

- 6 If there are other occupants besides the driver, evacuate such occupants to a safe place.
- 7 Judge if the flat tire can be repaired using the service kit for tire repair (stored in the storage box of the luggage compartment) and take the necessary action accordingly.

Warning

- If a tire becomes flat while driving, do not steer the vehicle or depress the brake suddenly. Doing so may cause the vehicle to lose its stability, leading to an accident.
- Do not drive the vehicle for even a short distance with a flat tire. Doing so may damage the wheels and disable normal driving, leading to a dangerous situation.
- Turn on the hazard warning lamp indicator, move the vehicle to the shoulder of the road or a safe location and place the warning triangle in a place easily identified by a driver in an approaching vehicle.
- If possible, park the vehicle on a flat, solid, and non-slippery road surface and repair the tire with no occupants in the vehicle.

Notice

- If you are not good at repairing a flat tire, request a KG Mobility Authorized Service Center or your auto insurance company for help.

Repairing a flat tire/inflating a tire using the service kit for tire repair

Components of the service kit for tire repair*

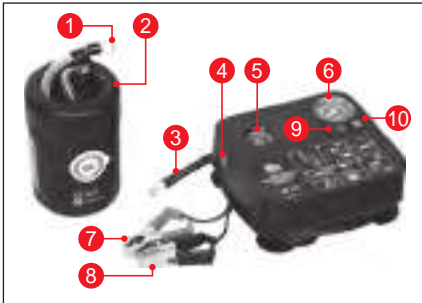

- 1 Sealant filler hose
- 2 Sealant
- 3 Air injection hose
- 4 Sealant removal button
- 5 Sealant mounting
- 6 Pressure gauge
- 7 Positive (+) cable
- 8 Negative (-) cable
- 9 Power switch
- 10 Deflating button

Storage location of the service kit

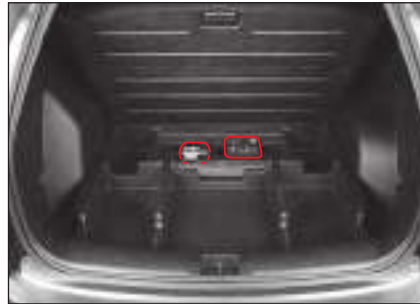

The service kit for tire repair is stored in the storage box at the rear left side of the luggage compartment with the OVM tools.

Confirming whether it is possible to repair the flat tire with the service kit or not

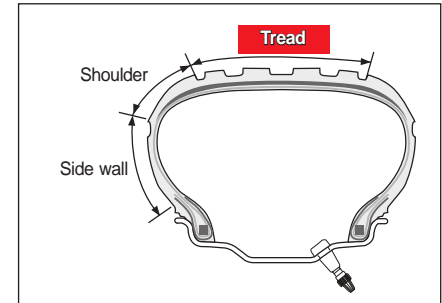

When a tire is flat, check the position of the hole first and use the service kit after judging whether it can be repaired using the service kit or not.

- If the size of the hole on the tread of the tire is less than 6 mm, it can be repaired using the service kit.

Warning

- Do not repair the tire using the service kit if the tire shoulder or the side wall is torn or there is a sign of cracks or damage. In such case, have the tire checked and serviced at a KG Mobility Authorized Service Center or contact your car insurance company.

Operating principle of the service kit

When the vehicle is driven after the sealant is injected using the compressor, the sealant is spread on the inner surface of the tire, filling up the hole and enabling temporary driving.



Repairing a flat tire

When a tire is flat, it can be repaired in the following method using the service kit.

- 1 Take out the tire repair service kit from the bottom of the luggage compartment board.



- 2 Remove the speed limit sticker on the side of the sealant container and attach it to the steering wheel.



Caution

- The speed limit sticker alerts the driver that the tire has been repaired using the service kit and the speed should be limited. Do not drive the vehicle at a speed faster than 110 km/h at any time.

- 3 Take out the sealant filler hose at the top of the sealant container.

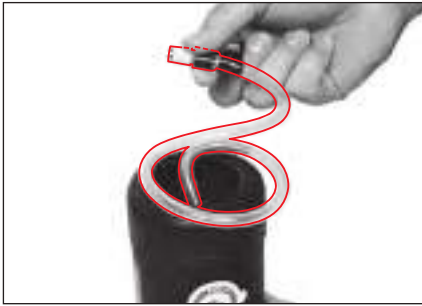

! Caution

- Check the expiration date of the sealant. The expiration date is marked on top of the sealant. Replace expired sealant with a new one since the sealing performance of the expired sealant may be degraded.
- Be sure to read the cautions on the container before using the sealant.

Notice

- Before using the sealant, shake the container well to mix the contents.

- 4 Fix the sealant container onto the compressor body completely.



- 5 Remove the air valve cap of the flat tire.
- 6 Connect the sealant filler hose which you took out at the sealant container to the air valve of the flat tire firmly.

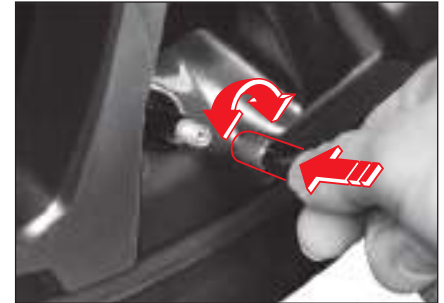

5

! Caution

- The power switch of the service kit should be in the OFF position.

- 7 Take out the + (red) / - (black) cables at the bottom of the compressor.

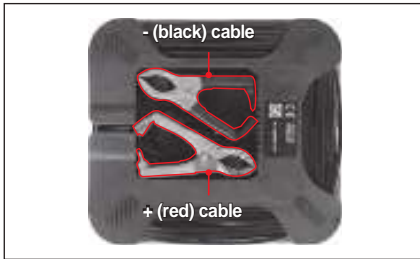

- 8 Connect the + (red) (1) cable of the service kit to the vehicle battery and then connect the - (black) (2) cable.

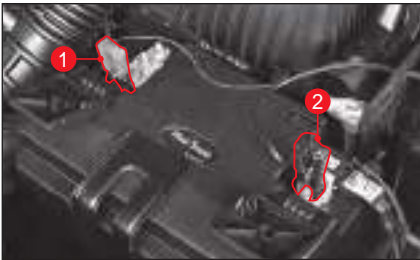

! Warning

- Use caution when connecting the cables. Sparks may occur.

! Caution

- Connecting the positive (+) and negative (-) terminals of the battery in reverse may result in damage to the battery and the tire service kit. Be sure to connect the cables in the correct order.
- Be sure to start with removing the negative (-) terminal (black cable) when disconnecting the cables.

- 9 Start the engine.

! Warning

- Be sure to repair a tire in a well-ventilated area. Failure to do so may lead to suffocation due to exhaust gas after starting the engine.

- 10 Press the power switch of the service kit to activate the compressor.

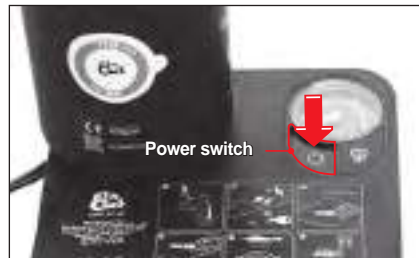

! Caution

- Do not operate the compressor for more than 10 minutes. Doing so may overheat the compressor, leading to a malfunction.

- 11 Wait until the pressure reaches the prescribed pressure (34psi, 2.3bar) while checking the pressure gauge of the service kit.

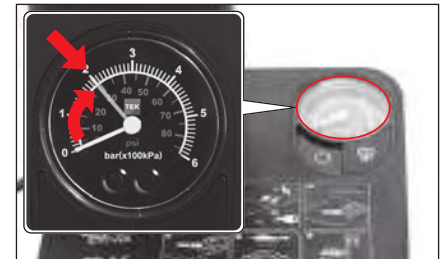



Warning

- If the specified tire pressure is not reached within 8 minutes (however, current tire pressure has reached at least 26 psi), re-inflate the tire as described below:
 1. Stop using the service kit and remove the sealant from the compressor.
 2. Place the service kit back in place (bottom of the luggage compartment board).
 3. Drive the vehicle at low speed for about 10 m so that the sealant is applied on the inner surface of the tire evenly.
 4. Fit the air injection hose at the compressor to the flat tire.
 5. Connect the power cable at the bottom of the compressor to the vehicle battery.
 6. Start the engine to operate the compressor.
 7. Operate the compressor until the tire pressure reaches to the specified value (34 psi, 2.3 bar).

If the tire is overinflated, press the air pressure release button to adjust the tire pressure.



- 12 When the prescribed pressure is reached, turn off the service kit.



Caution

- If the tire pressure does not go above 26psi after operating the compressor for more than 10 minutes, the tire cannot be repaired using the service kit. Request an emergency rescue service or vehicle towing.

- 13 Disconnect the air hose from the tire.
- 14 Install the air valve cap on the tire.
- 15 Turn off the engine.
- 16 Remove the sealant container and the air hose from the service kit and place the service kit back to its original position (bottom of luggage compartment board).
- 17 Drive the vehicle immediately for approximately 10 km to allow the sealant to be spread on the inner surface of the tire evenly.
- 18 Stop the vehicle at a safe place and measure the tire pressure with the service kit.



Warning

- Use the service kit only when a small hole (approximately 6 mm or less) has occurred on the tread of the tire.
- Do not use the service kit if the tire shoulder or side wall is torn or the hole is too large. In such case, have your vehicle towed or serviced at a KG Mobility Authorized Service Center.
- When a tire repaired using the service kit is fixed, drive the vehicle at a speed less than 80 km/h.
- The service kit should be used only for temporary repair. The maximum distance that can be traveled with a tire repaired by injecting sealant is approximately 200 km.
- If a vibration occurs or the steering is unstable and a noise occurs while driving, stop driving the vehicle immediately. In such case, have your vehicle serviced at a KG Mobility Authorized Service Center.



Caution

- Remove the sealant container carefully to prevent the sealant from coming into contact with your skin. If sealant comes into contact with your skin, wash it with soapy water.
- The sealant container cannot be used after it is used once. Just in case, purchase and replace with new sealant.
- Do not discard the used sealant container anywhere. Return it to a KG Mobility Authorized Service Center.
- Do not use an unauthorized sealant which is not KG Mobility genuine sealant. Doing so may damage the sensor of the TPMS.
- Replace the tire repaired using the sealant with a new one at a KG Mobility Authorized Service Center as soon as possible and have the TPMS checked for abnormality.
☞ Refer to "Tire pressure monitoring system (TPMS)" (p.2-29)

Checking the tire pressure after repairing a flat tire

The pressure of the tire repaired using the service kit should be checked as follows after driving for approximately 10 km.

- 1 Take out the tire repair service kit from the bottom of the luggage compartment board.
- 2 Take out the air hose from the service kit.
- 3 Remove the air valve cap of the tire.
- 4 Connect the air hose of the service kit to the air valve on the tire firmly.
- 5 Check the tire pressure from the pressure gauge of the service kit.

If the tire pressure is higher or lower than the prescribed pressure (34psi, 2.3bar), adjust it to the prescribed pressure using the air valve of the tire.



Warning

- If the tire pressure is not maintained at the prescribed pressure (34psi, 2.3bar), stop driving the vehicle immediately and request a KG Mobility authorized service for help.

Inflating a tire

When the tire pressure is insufficient, you can inflate the tire to the prescribed pressure with the following method using the service kit.

- 1 Take out the tire repair service kit from the bottom of the luggage compartment board.
- 2 Take out the air hose (1) and the power cable (2) from the service kit.

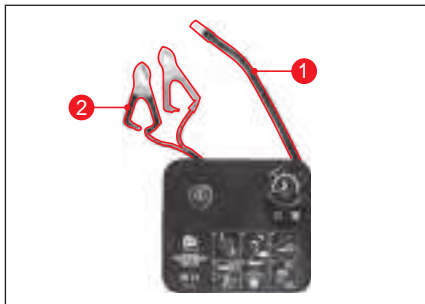

- 3 Remove the air valve cap of the tire you wish to inflate.
- 4 Connect the air hose of the service kit to the air valve on the tire firmly.



Caution

- The power switch of the service kit should be in the OFF position.

- 5 Take out the + (red) / - (black) cables at the bottom of the compressor.

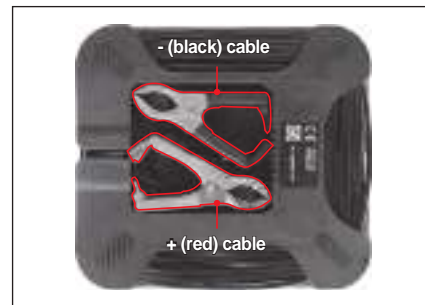

- 6 Connect the + (red) (1) cable of the service kit to the vehicle battery and then connect the - (black) (2) cable.

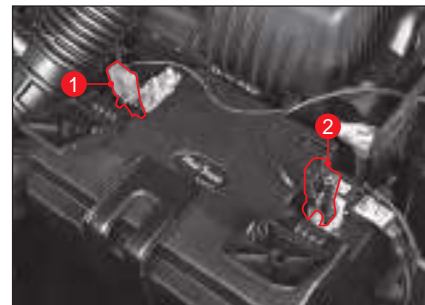

5

7 Start the engine.



Warning

- Be sure to repair a tire in a well-ventilated area. Failure to do so may lead to suffocation due to exhaust gas after starting the engine.

8 Press the power switch (1) of the service kit to activate the compressor.

9 Wait until the pressure reaches the prescribed pressure (34psi, 2.3bar) while checking the pressure gauge (2) of the service kit.

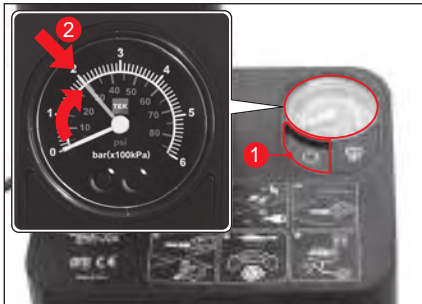

If the tire is overinflated, press the air pressure release button to adjust the tire pressure.



10 When the prescribed pressure is reached, press the power switch (1) of the service kit to turn it off.



Caution

- Do not operate the compressor for more than 10 minutes. Doing so may overheat the compressor, leading to a malfunction.

- 11 Turn off the engine.
- 12 Disconnect the air hose from the tire.
- 13 Install the air valve cap on the tire.
- 14 Place the service kit back to its original position (storage box at the rear left side of the luggage compartment).

Removing the spare tire (Temporary)*



Open the cover in luggage compartment and remove the spare tire.



Caution

- When reinstalling the spare tire to the carrier, be sure to securely lock it to the carrier holder.
- While your vehicle is being raised up with the jack, avoid any impact on your vehicle. Otherwise, you may get injured.



Warning

- The emergency spare tire is only for emergency situations. Never use it for normal driving. After installing the spare tire on a wheel, take your vehicle to a **KG Mobility Authorized Service Center** or a tire-specialized shop to replace it with a new regular tire.

Changing a spare tire (Temporary)



- 1 Check the front and rear of the wheel diagonally opposite to the wheel being changed.



Warning

- The parking brake should always be applied when replacing the flat tire.

- 2 Loosen the wheel nuts two or three turns by turning them counterclockwise with the wheel nut wrench.



Caution

- When reinstalling the wheel cap, be sure to completely fit it into its location.



Warning

- Do not remove the nuts yet from the wheel. If they are removed, the wheel could slip off from the vehicle. Then, the body of the vehicle will fall down on you and you may get seriously injured.
- Loosen the wheel nuts two or three turns.
- The parking brake should always be applied when replacing the flat tire.
- Check the front and rear of the wheel opposite to the wheel being changed.

When replacing a front tire

5

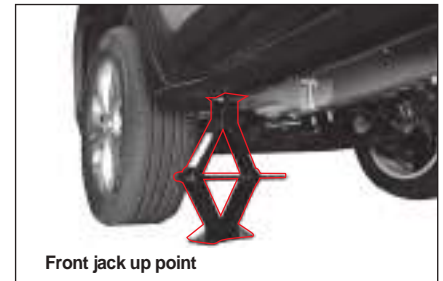

Front jack up point

- 3 Place the jack directly under the jack-up points so that the top of the jack contacts the vehicle at the jack-up point.



Warning

- The jack should be used on level firm ground wherever possible.
- It is recommended that the wheels of the vehicle be chocked, and that no person should remain in a vehicle that is being jacked.
- No person should place any portion of their body under a vehicle that is supported by a jack.
- Jack working load limit 1,300 kg.

When replacing a rear tire

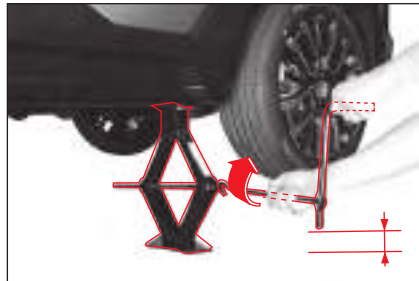
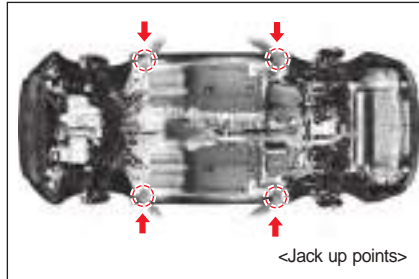
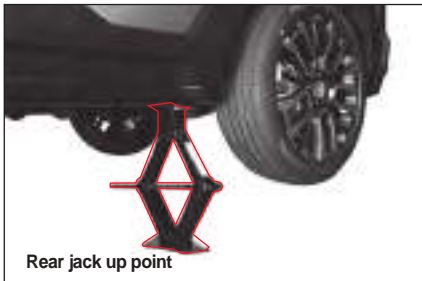

- 4 Combine the jack, jack extension and the wheel nut wrench as shown in the figure. Raise up the vehicle by rotating the combined wrench clockwise until the tire is off from the ground about 3 cm.

- 5 Remove the wheel nuts by hands while the vehicle is stationary. Remove all of the wheel nuts.



Warning

- Do not attempt to raise the vehicle until the jack is in the proper position, and secure both to the vehicle and the ground. It may cause a personal injury or vehicle damage.

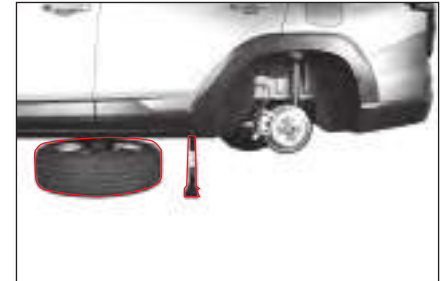

- 6 Take the wheel off and place the wheel under the vehicle body. This helps to minimize any danger if the jack slip off position.

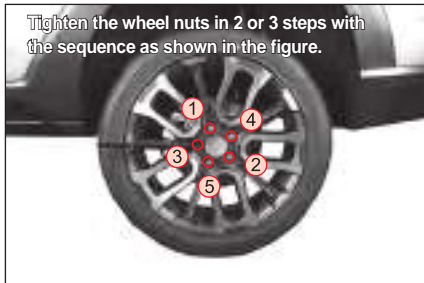

7 Then mount the tighten the wheel nuts until the temporary tire wheel is no longer loose.

Warning

- By tightening up the spare tire until it is not loose any more, you can avoid any tilting of the tire on the wheel hub when the tire touches the ground.

8 Lower the vehicle by rotating the combined wrench counter-clockwise until the tire touches the ground. Remove the jack.

Warning

- While the jack is supporting your vehicle, do not use too much force to tighten the nuts. Otherwise, the vehicle may slip off and you may get injured.

9 Tighten the wheel nuts in 2 or 3 steps with the sequence as shown in the figure.

10 When done with mounting the spare tire, place the flat tire in the luggage room. Store the jack and other emergency tools in their storages.



If over tightened, the wheel nuts could be damaged. Do not overtighten the wheel nuts by pressing the wheel nut wrench by foot or using an assist pipe.

Caution

- After changing the tire and driving the vehicle about 1000 km, retighten the wheel nuts.
- Wheel nut tightening torque: 120 ~ 140 Nm

Warning

- With the emergency spare tire, do not drive any faster than 60 km/h.
- The temporary spare tire is only for emergency situations. Never use it for normal driving. After installing the spare tire on a wheel, take your vehicle to a KG Mobility Authorized Service Center or a tire-specialized shop to replace it with a new regular tire.
- Improperly tightened wheel nuts can cause the wheel to become loose and even come off or any malfunctioning in the steering and braking system.
- This could lead to an accident. Be sure to tighten the wheel nuts as specified. If the wheel comes off due to a loose wheel nut, you may have a fatal accident.
- Using different tires could cause you to lose control while driving. Be sure to use the same size and type tires from the same manufacturer on all wheels.

Cautions when changing the tire



Caution

► Before changing the tire

- Turn on hazard flashers and move off the road to a safe place away from traffic. Park on a firm and level ground.
- Set up the jack at the specified position. Never get under the vehicle while it is supported by the jack. While the vehicle is on the jack, never start or run the engine or push the vehicle.
- Have all passengers get out of the vehicle and stay in a place away from traffic.

► During changing the tire

- Do not completely tighten the wheel nuts at a time. Tighten the wheel nuts in the diagonal sequence in 2 or 3 steps.
- Never apply oil or grease to either wheel studs or nuts as it will cause them to overtighten.

► After changing the tire

- Check, repair, and retighten the replaced tire at the nearest KG Mobility Authorized Service Center or a qualified tire shop after an emergency change.
- Securely fix the tire in its carrier. Check to see if the spare tire is securely locked into the carrier without any looseness. Otherwise, it may make some abnormal noises or fall out from the carrier on the road while the vehicle is moving. This may cause an accident or hit a pedestrian.
- If this happens, the fallen tire can be a great danger to other vehicles or people. Check the tightness of the wheel nuts and tire pressure before driving.
- The spare tire is designed as an emergency spare only. Do not exceed 60 km/h speed when the spare tire is installed on the vehicle.



Caution

- Repair or change the flat tire. Stow the emergency tire in its location properly.
- Make sure to check the tightness and inflation pressure of tires before driving.
- In the vehicle equipped with TPMS, the TPMS warning lamp comes on and TPMS does not work when installing the emergency tire.



Warning

- Make sure that tighten the wheel nuts again after driving of about 1,000 km when the tires have been replaced.
- Drive the vehicle at the speed of 60km/h or less (maximum speed 80 km; maximum distance 200 km) when the vehicle is driven with the spare tire.
- Drive the vehicle in 2H mode when the spare tire is fitted. When driving in 4H mode, it will damage the drive system.
- Be sure to use the same size and type tires so that the vehicle characteristics can be maintained safely.

When you need to have your vehicle towed

Towing a disabled vehicle

- Flat towing

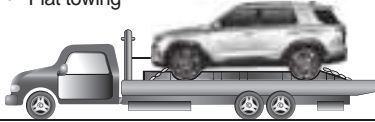

- Towing with front wheels on ground

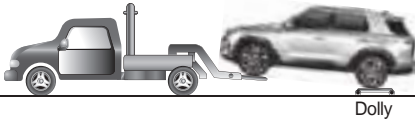

- Towing with rear wheels on ground

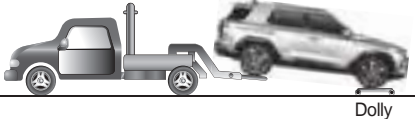

Towing with tow truck

The best towing method is to lift the entire vehicle onto the flatbed so that all wheels are off the ground. If it is impossible, put the front or rear wheels on the jig and tow the vehicle using a dolly, with other wheels off the ground.

For 4WD vehicle

Your vehicle must be towed with a wheel lift and dollies or flatbed equipment with all the wheels off the ground.

Warning

- The 4WD system equipped vehicle should never be towed with the wheels on the ground. This can cause serious damage to the transmission or the 4WD system.
- If your vehicle should be towed due to wheel slips in mud or sand, you can use the towing hooks in your vehicle. However, if the load to hooks is too heavy, the towing hook, rope or chain could be broken, resulting in serious personal injury and vehicle damage.
- To prevent damage to your vehicle, proper lifting and towing procedures are necessary. When you need a towing service, contact KG Mobility Dealer or KG Mobility Authorized Service Center.

For 2WD vehicles

It is not allowed to use a tow truck or keep the rear wheels from moving with the parking brake released for towing, as shown in the following figure.

Caution



- Do not tow with the sling-type equipment or the bumper and lower parts can be damaged.
- If the vehicle is towed with the driving wheels on the ground, the transmission may be damaged.
- Be careful not to damage the bumper and lower parts during towing.

When a tow truck is unavailable (in case of emergency)

If your vehicle needs to be towed when a tow truck is unavailable, you can have your vehicle towed by installing the towing hook to a towing vehicle and the vehicle to be towed and connecting the two vehicles with the towing rope (sold separately).

Installing the towing hook

- 1 Take out the towing hooks from the OVM tools stored in the storage box at the rear left side of the luggage compartment.
- 2 Press the bottom side (1) of the hole cover located in the front bumper of the vehicle to be towed and the rear bumper of the towing vehicle each to remove the cover.
- 3 Insert the towing hook into each hole and fasten it firmly.

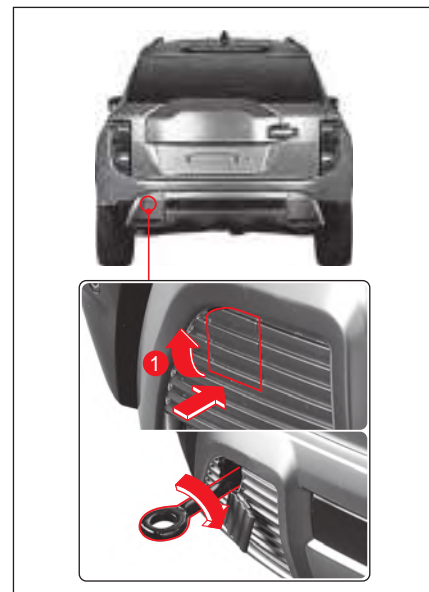
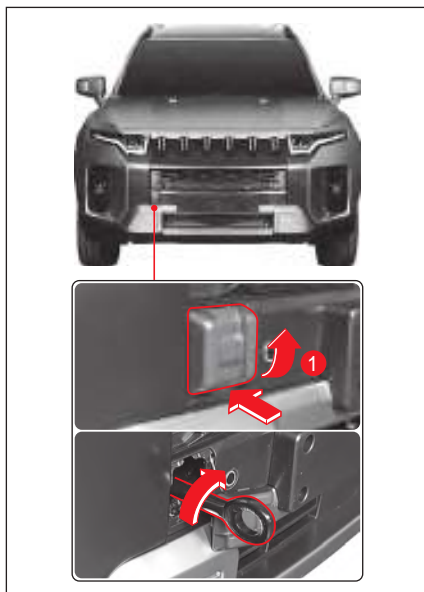

Using a towing rope

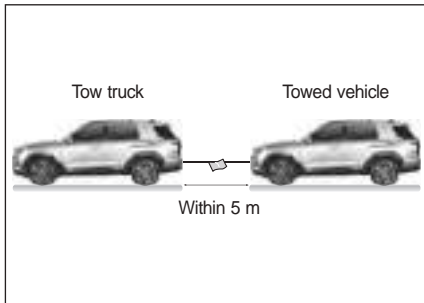

- 1 Connect the towing rope to the towing hook of the towing vehicle and the vehicle to be towed securely.
- 2 Tie a white cloth in the middle of the rope so that the towing rope is clearly visible.
- 3 Release the parking brake of the vehicle to be towed and place the gear shift lever in the N (neutral) position.
- 4 If the engine of the vehicle to be towed is turned off, place the START/STOP switch in the ON position.
- 5 Turn on the hazard warning lamp of both the towing vehicle and the vehicle to be towed.

- 6 Start the engine of the towing vehicle and tow the vehicle to be towed.

At this time, the length of the towing rope should be less than 5 m and the total length of the towing vehicle and the vehicle to be towed should not exceed 25 m.

Tow the vehicle at a speed of 5 km/h or less.

Warning

- Use the towing hook only for towing a vehicle for a short distance temporarily or in an emergency situation. Avoid using it for towing all the time.
- If you want to tow the vehicle using the towing hook, make sure that the force is applied in the front, rear and horizontal direction. Do not drive off suddenly or recklessly since it can apply excessive load to the towing hook. Doing so may damage the towing rope or chain, leading to vehicle damage or a serious injury.

Caution

- Avoid impractical towing and towing a vehicle which is heavier than the towing vehicle.
- If there are many steep downhill slopes in the towing path, do not attempt to tow the vehicle using the towing hook.
- The brake performance is significantly lowered while the engine is not running. Therefore, depress the brake pedal stronger than usual when towing the vehicle using the towing hook.
- Tow the vehicle while operating the turn signal and the hazard warning lamp along with the towing vehicle's signals.

Trailer towing

Your vehicle is designed primarily as a passenger vehicle therefore handling, braking, durability and economy will be affected by towing a trailer.

Your safety and satisfaction depend upon proper use of correct equipment. Also, you should avoid overloading and other abusive use.

The maximum loaded trailer weight you can pull with your vehicle depends on your intended use and what special equipment has been installed on it. Before attempting any towing, ensure that the correct equipment is fitted to your vehicle.

Your KG Mobility Dealer will help supply and install towing equipment to suit your requirement.

Trailer loading

To load your trailer properly, you must know how to measure gross trailer weight and trailer ball weight. Gross trailer weight is the weight of the trailer plus all cargo in it.

You can measure gross trailer weight by putting the fully loaded trailer on a vehicle scale.

Trailer ball weight is the downward force exerted on the hitch by the trailer coupler at its normal towing height. This weight can be measured using a bathroom scale.

The weight of your loaded trailer (gross trailer weight) should never exceed the specified values.

The permissible trailer loads are valid for several gradients from 6.8% to 12.6% according to engine power applied.

When the trailer has been coupled, the permissible rear axle load for the fully loaded towing vehicle (including occupants) must not be exceeded.

Maximum Load Limits

(unit: kg)

Engine	Type	Maximum Trailer	Trailer coupling weight	
			Maximum permissible static vertical load on the coupling device	Maximum trailer hitch
G15DTF (M/T)	with brake	1,500	60	25
	without brake	750		
G15DTF (A/T)	with brake	1,500	60	25
	without brake	500		

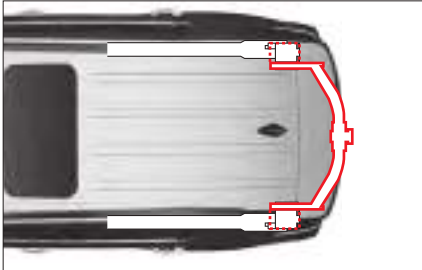
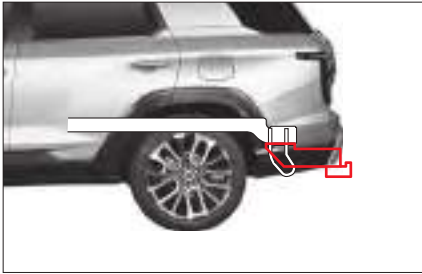

If you want to pull a trailer

Important points:

- You have to consider a sway control. You can check the sway control to hitch dealer.
- If the total driving distance of your new vehicle is under 800 km (500 miles), do not tow a trailer. For the first 800 km (500 miles) that you tow a trailer, do not drive over 80 km/h (50 mph) and do not start off your vehicle at full throttle. Otherwise, your engine and other parts could be damaged due to heavier loads.
- Always drive your vehicle at a moderate speed (less than 80 km/h).
- You have to consider the weight of trailer.
- The permissible trailer ball weight varies according to the cargo weight on the deck.
- It has to be limited to the number of passengers by 5 people including a driver.

Weight of trailer

To keep the vehicle and trailer safely, you must consider many factors except the maximum load limit.

The vehicle and trailer's safety depends on how you use your trailer. Vehicle speed, altitude, load, outside temperature and frequency of using trailer are all very important. Any special equipment on your vehicle also affects on your vehicle.

Weight of trailer tongue

The tongue load of a trailer is also considered very carefully because it affects the gross vehicle weight (GVW) of your vehicle. This weight includes the curb weight of vehicle, any luggage in trailer, and the passengers in vehicle. In addition to that, you must add the trailer tongue load to the GVW because your vehicle will carry all the weight.

The trailer tongue should weigh a maximum of 4% of total loaded trailer weight. To check the weights are proper, you must weigh the trailer and the tongue separately after loading. If the weights are not proper, unload some items from the trailer.

Caution

- **Never load a trailer with more weight in the rear side than in the front side. (Recommendation - Front: approx. 60%, Rear: approx. 40%)**
- **Never exceed the maximum load limits of trailer or trailer towing equipment. Improper loading may result in damage to your vehicle. It may occur the personal injury. Before driving, check the weight and loading at a commercial scale or highway patrol office equipped with scales.**
- **An improperly loaded trailer may cause the loss of vehicle control.**
- **When towing the trailer, turn the Idle Stop & Go (ISG) system off.**

Trailer brakes

If the trailer brakes are used, you should follow all instructions provided by the manufacturer. Never modify the brake system of your vehicle.

Trailer lights

Make sure your trailer is equipped with lights which meet country and local requirements.

Always check for the proper operation of all trailer lights before you start to tow.

Tires

When towing trailers, be sure your tires are properly inflated to the inflation pressure.

Safety chains

Always attach safety chains between your vehicle and the trailer. Cross the safety chains under the tongue of the trailer so that the tongue will not drop to the road if it becomes separated from the hitch. Follow the manufacturer's recommendation for attaching safety chains. Always leave just enough slack to permit full turning. Never allow safety chains to drag on the road.

Brake fluid

Change the brake fluid every 15,000 km (9,000 miles) under the following conditions.

- Towing a trailer frequently.
- Driving in hilly or mountainous terrain.

Automatic transmission fluid

More frequent maintenance is required if your vehicle tows trailer frequently.

Towing tips

When towing a trailer, your vehicle will handle differently compared with normal driving condition.

- For safety, observe the following precautions:
- Practice turning, stopping, and reversing before you begin towing in traffic. Do not tow in traffic until you are confident that you can handle the vehicle and trailer safely.
- Before driving, make sure that the lighting system of the trailer works properly.
- Do not drive faster than 80 km/h.
- Make sure that you have enough room when cornering and avoid sudden maneuvers.
- Avoid abrupt starts, acceleration or stops.
- Avoid sharp turns or lane changes.
- Always have someone guide you when reversing.

- Allow adequate stopping distance. Stopping distance is increased when you tow a trailer.
- Avoid holding the brake pedal down too long or too frequently, which will cause the brakes to overheat and result in reduced brake efficiency.
- Always block the wheels on both vehicle and trailer when parking. Apply the parking brake firmly.
- Parking on a steep slope is not recommended. You really should not park your vehicle, with a trailer attached, on a hill. If something goes wrong, such as the trailer/ caravan hitch becoming disengaged, people can be injured and both the vehicle and trailer can be damaged.
- If someone removing the blocks stands directly behind the trailer, he could be injured. If your brakes or the hitch slipped, the trailer could roll backward. Make sure anyone removing blocks from your wheels stands to one side.
- Take note of trailer manufacturer's instructions.

Driving on hill

Reduce speed and shift to a lower gear before you start down a long or steep downgrade. If you don't shift down, you might have to use your brakes so much that they would get hot and no longer work well.

On a long uphill grade, shift down and reduce your speed to a level which minimizes the possibility of engine and transmission overheating.

Notice

- **When towing a trailer on steep hill (over 12%), pay particular attention to the engine coolant temperature gauge to ensure the engine does not overheat. If the gauge reaches to the "H" mark, stop your vehicle at a safe place and allow the engine to idle until it cools down. When the engine has cooled sufficiently, you may proceed.**
- **To avoid the engine and transmission overheating, you must check the driving speed depending on trailer weight and uphill grade.**

Parking on hills

You really should not park your vehicle, with a trailer attached, on a hill. If something goes wrong, your rig could start to move. People can be injured, and both your vehicle and the trailer can be damaged.

But if you ever have to park your rig on a hill, here's how to do it:

- 1 Apply your regular brakes, but don't shift into PARK (P) for automatic transmission yet, or into a gear for a manual transmission.
- 2 Have someone place chocks under the trailer wheels.
- 3 When the wheel chocks are in place release the regular brakes until the chocks absorb the load.
- 4 Reapply the regular brakes. Then apply your parking brake, and then shift to PARK (P) for automatic transmission, or First or Reverse gear for a manual transmission.
- 5 Release the regular brakes.

When you are ready to leave after parking on a hill

- 1 Apply your regular brakes and hold the pedal down while you:
 - Start your engine
 - Shift into a gear and
 - Release the parking brake.
- 2 Let up on the brake pedal.
- 3 Drive slowly until the trailer is clear of the chocks.
- 4 Stop and have someone pick up and store the chocks.

Maintenance when towing trailer

Your vehicle will need service more often when you're towing a trailer. See the maintenance Schedule for more on this. Things that are especially important in trailer operation are engine oil, brake pads & discs, automatic transmission fluid. Each of these is covered in this manual and the index will help you find them quickly. If you want to tow a trailer, it's a good idea to review these sections before you start your trip.

Check periodically to see that all hitch nuts and bolts are tight.

When the vehicle has stopped due to a failure

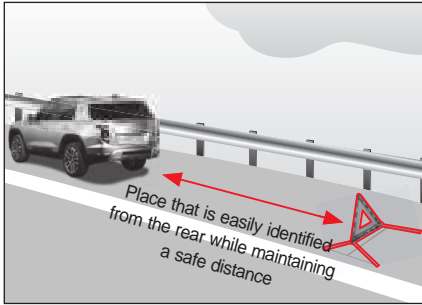

If the vehicle malfunctions and has stopped while driving, do not panic and take an action according to the following order.

- 1 Turn on the hazard warning lamp of the vehicle.
- 2 Move your vehicle to the right shoulder of the road or a safe location.
- 3 Place a warning triangle.
The position that is easily identified by a driver in an approaching vehicle while maintaining a safe distance (100 m during daytime, 200 m in the rear during night time) is an appropriate area to place the warning triangle.
Place a road flare additionally at night.
- 4 Evacuate all occupants to a safe place.
- 5 Request an emergency rescue service or vehicle towing.

In the event of an accident

If an accident has occurred while driving, do not panic and take an action according to the following order.

- 1 Turn on the hazard warning lamp of the vehicle.
- 2 Move your vehicle to the right shoulder of the road or a safe location.
- 3 Place a warning triangle.

The position that is easily identified by a driver in an approaching vehicle while maintaining a safe distance (100 m during daytime, 200 m in the rear during night time) is an appropriate area to place the warning triangle.

Place a road flare additionally at night.

- 4 Evacuate all occupants to a safe place.
- 5 If anyone is injured, give aid and call an ambulance.
- 6 Contact the nearest police station and when a police officer arrives, follow his/her instructions.
- 7 Even in case of a minor accident, be sure to visit a hospital and see the doctor.

Tips when an accident or a malfunction occurs on the expressway

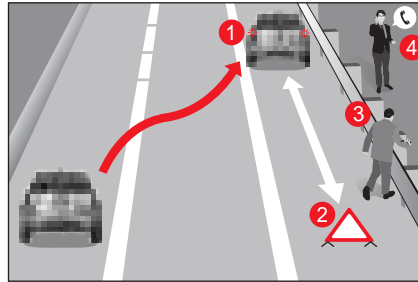

When you stop the vehicle on the expressway due to an accident or a malfunction, take an action according to the following order in order to prevent a secondary accident.

- 1 Turn on the hazard warning lamp promptly and move the vehicle to the shoulder of the road (1).
- 2 Place a warning triangle on the rear side of the vehicle (2). (Place a road flare additionally at night)
- 3 The driver and any occupants should be evacuated to a safe area such as behind the guardrail (3).
- 4 If you need help, contact the police, fire department, or highway department.

In the event of a fire

When a fire has occurred in the vehicle, do not panic and take an action according to the following order.

- 1 Turn on the hazard warning lamp of the vehicle.
- 2 Stop the vehicle at a safe place immediately and stop the engine.
- 3 Extinguish the fire using an extinguisher.
- 4 If you cannot extinguish the fire, report it to a police station or a fire station.
At this time, do not approach the vehicle and maintain a safe distance with the vehicle.



Warning

- When a vehicle accident occurs, the fuel may leak, causing a fire. Stop the engine immediately and keep any inflammables away from the vehicle.



Placing an extinguisher in the vehicle

Place an extinguisher in the vehicle since it is needed for early fire extinguishing when a fire occurs.

How to use the extinguisher

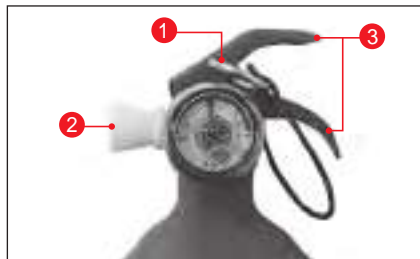

- 1 Remove the safety pin (1) from the extinguisher with the wind at your back.
- 2 Face the extinguisher nozzle (2) towards the place where the fire occurs.
- 3 Hold the handle (3) and spray to the place where the fire occurs, using a sweeping motion.

Checking and maintaining the extinguisher

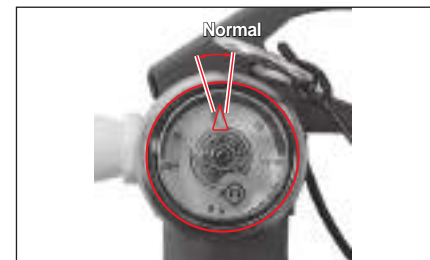

- Check at least once a month if the needle on the pressure gauge of the extinguisher is in the normal range.
If there is a pressure loss or other abnormalities, have the extinguisher serviced immediately.
- The lifetime of the extinguisher is approximately 5 years when it is maintained under normal conditions.
After 5 years have passed, it should be inspected and confirmed by a fire fighting equipment company every 2 years.
- After using the extinguisher, be sure to release the chemical (ABC powder) from the inside of the extinguisher completely and refill with an ABC powder fire extinguishing agent.
If it is left unattended for a long period of time, the contents may become hardened and it cannot be used. Shake the extinguisher periodically.

In the event of a heavy snow

When there is a heavy snow, do not panic and refer to the following tips for actions.

- Always listen to the radio and use the expressway information call number.
- Drive slowly on a curved road, an uphill road or a bridge.
- Avoid parking or leaving the vehicle on the shoulder of the road that cause inconvenience for snow removal operations.
- Be sure to leave your contact information when you leave the vehicle unavoidably.
- Drive slowly while securing a safe distance between vehicles.
- Avoid using the brake and stop the vehicle while reducing the vehicle speed using the engine brake.
- Remove snow near the vehicle frequently to prevent the exhaust pipe (muffler) from being blocked.

<https://www.automotive-manuals.net/>

6. Periodic Checking and Maintenance

You can check the necessary periodic check and maintenance methods in detail for safe and pleasant vehicle driving.

Scheduled maintenance services - gasoline engine

* Use only approved KG Mobility genuine parts.

Maintenance service and record retention are the owner's responsibility. You should retain evidence that proper maintenance has been performed on your vehicle in accordance with the scheduled maintenance service chart.

Maintenance item	Maintenance interval	Kilometers (miles) or time in months, whichever comes first								
		x1000 km	15	30	45	60	75	90	105	120
		x1000 miles	10	20	30	40	50	60	70	80
		Months	12	24	36	48	60	72	84	96

Engine control system

Drive belt		I	I	I	I	I	I	I	I	
Engine oil & engine oil filter (1)* (3)* (Initial check: 7500 km)		R**	R	R	R	R	R	R	R	
	Shorten the service interval under severe conditions									
Cooling system hose & connections		I	I	I	I	I	I	I	I	
Engine coolant (3)*	Change every 200000 km or 5 years. And, inspect replenish if necessary.									
Fuel filter (2)*	Inspect every 30000 km (if using poor quality of fuel, replace every 50000 km)									
Fuel line & connections		I	I	I	I	I	I	I	I	
Air cleaner (2)*		I	R	I	R	I	R	I	R	
	Shorten the service interval under severe conditions									
Ignition timing		I	I	I	I	I	I	I	I	
Spark plugs	G15DTF	Change every 60000 km								
Charcoal canister & vapor lines		-	I	-	I	-	I	-	I	

Chart Symbols:

I - Inspect these items and their related parts. If necessary, correct, clean, replenish, adjust or replace.

R - Replace or change.

** - In order to secure engine long life and effective break-in, first oil (factory filled) would be recommended to drain within 10000 km.

(1)* If vehicle is operated under severe condition: Shorten the service interval.

- Frequent stop-and-go traffic, extended idling, short driving distance below 6 km, driving distance below 16 km when the outside temperature remains below freezing

- Driving in a hilly or mountainous terrain, sandy, or dusty area

- High load driving such as trailer towing

- Taxi, patrol service or delivery service (extended idling and excessive driving with low speed)

(2)* If vehicle is operated under severe condition, pollutant area or off-road driving, driving in dusty condition or sandy condition, frequently inspect the air cleaner, if necessary, change the air cleaner.

(3)* Refer to "Recommended fluids and lubricants".

Maintenance item	Maintenance interval	Kilometers (miles) or time in months, whichever comes first								
		x1000 km	15	30	45	60	75	90	105	120
		x1000 miles	10	20	30	40	50	60	70	80
Months	12	24	36	48	60	72	84	96		

Chassis and body

Exhaust pipes & mountings	I	I	I	I	I	I	I	I	I
Brake / Clutch fluid (3)*	Change every 2 years (inspect frequently)								
Parking brake / Brake pads (Front & Rear) (4)*	I	I	I	I	I	I	I	I	I
Brake line & connections (including booster)	I	I	I	I	I	I	I	I	I
Manual transaxle oil (5)*	Inspect and replenish every 60000 km (or 3 years) (Severe driving condition: Change every 120000 km)								
Clutch & brake pedal free play	I	I	I	I	I	I	I	I	I
Power transfer unit oil (6)*	I	I	I	R	I	I	I	I	R
Rear axle oil	Inspect every 15000 km, change every 100000 km (Frequent check of oil leak)								
Automatic transaxle fluid (6)*	Change every 100000 km under severe condition								
Check play/tightness for lower bolt/nut and ball joint grease leak on chassis and body (6)*	Check frequently and adjust or replace if necessary								

Chart Symbols:

I - Inspect these items and their related parts. If necessary, correct, clean, replenish, adjust or replace.

R - Replace or change.

(3)* Refer to "Recommended fluids and lubricants".

(4)* More frequent maintenance is required if the vehicle is operated under any of the following conditions:

- In heavy city traffic where the outside temperature regularly reaches 32°C (90°F) or higher, or
- In hilly or mountainous terrain, or
- When doing frequent trailer towing, or
- Uses such as found in taxi, police or delivery service.

(5)* Inspect and replenish every 60000 km (or 3 years)

Normal driving condition: Fill for Life

(Severe driving condition: Change every 120000 km)

(6)* If vehicle is operated under severe condition: Shorten the service interval.

- Towing a trailer or off-road driving (Inspect the leak of fluid at any time, occasionally)
- Taxi, patrol service or delivery service (extended idling and excessive driving with low speed)
- Frequent stop-and-go traffic, extended idling, short driving distance
- Driving in a hilly or mountainous terrain, sandy, or dusty area
- Driving frequently at high speed over 170 km/hour
- Driving frequently in area where heavy traffic under the ambient temperature above 32°C

Maintenance item	Maintenance interval	Kilometers (miles) or time in months, whichever comes first								
		x1000 km	15	30	45	60	75	90	105	120
		x1000 miles	10	20	30	40	50	60	70	80
	Months	12	24	36	48	60	72	84	96	

Chassis and body

Tire condition & inflation pressure	Check frequently and adjust or replace if necessary							
Wheel alignment (7)*	Inspect when abnormal condition is noted							
Steering wheel & linkage	I	I	I	I	I	I	I	I
Outer ball joint inspection and replacement	I	I	I	I	I	R	I	I
Drive shaft boots (8)*	I	I	I	I	I	I	I	I
Seat belts, buckles & anchors	I	I	I	I	I	I	I	I
Lubricate locks, hinges & bonnet latch	Check frequently and adjust or replace if necessary							
Wheel bearing grease	I	I	I	I	I	I	I	I
Propeller shaft grease - Front / Rear (9)*	I	I	I	I	I	I	I	I
Air conditioner filter (10)*	R	R	R	R	R	R	R	R
	Shorten the service interval under severe conditions							

Chart Symbols:

I - Inspect these items and their related parts. If necessary, correct, clean, replenish, adjust or replace.

R - Replace or change.

(7)* If necessary, rotate and balance wheels.

(8)* After completion of off-road operation, the drive shaft boots should be inspected.

(9)* Inspect propeller shaft grease every 5000 km or 3 months if the vehicle is mainly driven under severe condition.

- In off-road or dusty road, or
- In heavy city traffic where the outside temperature regularly reaches 32°C (90°F) or higher, or
- In hilly or mountainous terrain.

(10)* Severe Conditions in Air Conditioner Filter

- Pollutant area or off-road driving, extended air conditioner or heater operation

Scheduled maintenance services (under severe condition) - gasoline engine

* Use only approved KG Mobility genuine parts.

Maintenance service and record retention are the owner's responsibility. You should retain evidence that proper maintenance has been performed on your vehicle in accordance with the scheduled maintenance service chart.

Maintenance item	Maintenance interval	Kilometers (miles) or time in months, whichever comes first								
		x1000 km	7.5	15	22.5	30	37.5	45	52.5	60
		Months	6	12	18	24	30	36	42	48

Engine control system

Drive belt		I	I	I	I	I	I	I	I
Engine oil & engine oil filter (1)* (3)*		R**	R	R	R	R	R	R	R
Cooling system hose & connections		I	I	I	I	I	I	I	I
Engine coolant (3)*		Change every 100000 km or 3 years. And, inspect replenish if necessary.							
Fuel filter (2)*		Inspect every 15000 km (if using poor quality of fuel, replace every 30000 km)							
Fuel line & connections		I	I	I	I	I	I	I	I
Air cleaner (2)*		I	R	I	R	I	R	I	R
Ignition timing		I	I	I	I	I	I	I	I
Spark plugs	G15DTF	Change every 40000 km							
Charcoal canister & vapor lines		-	I	-	I	-	I	-	I

Chart Symbols:

I - Inspect these items and their related parts. If necessary, correct, clean, replenish, adjust or replace.

R - Replace or change.

** - In order to secure engine long life and effective break-in, first oil (factory filled) would be recommended to drain within 7500 km.

(1)* If vehicle is operated under severe condition:

Shorten the service interval.

- Frequent stop-and-go traffic, extended idling, short driving distance below 6 km, driving distance below 16 km when the outside temperature remains below freezing

- Driving in a hilly or mountainous terrain, sandy, or dusty area

- High load driving such as trailer towing

- Taxi, patrol service or delivery service (extended idling and excessive driving with low speed)

(2)* If vehicle is operated under severe condition, pollutant area or off-road driving, driving in dusty condition or sandy condition, frequently inspect the air cleaner, if necessary, change the air cleaner.

(3)* Refer to "Recommended fluids and lubricants".

Maintenance item	Maintenance interval	Kilometers (miles) or time in months, whichever comes first								
		x1000 km	7.5	15	22.5	30	37.5	45	52.5	60
		Months	6	12	18	24	30	36	42	48

Chassis and body

Exhaust pipes & mountings	I	I	I	I	I	I	I	I	I
Brake / Clutch fluid (3)*	Change every 1 years (inspect frequently)								
Parking brake / Brake pads (Front & Rear) (4)*	I	I	I	I	I	I	I	I	I
Brake line & connections (including booster)	I	I	I	I	I	I	I	I	I
Manual transaxle oil (5)*									I
Clutch & brake pedal free play	I	I	I	I	I	I	I	I	I
Power transfer unit oil (6)*	I	I	I	I	I	I	I	I	R
Rear axle oil	Inspect every 7500 km, change every 50000 km (Frequent check of oil leak)								
Automatic transaxle fluid (6)*	Change every 100000 km under severe condition								
Check play/tightness for lower bolt/nut and ball joint grease leak on chassis and body (6)*	Check frequently and adjust or replace if necessary (change every 100000 km only ball joint)								

Chart Symbols:

I - Inspect these items and their related parts. If necessary, correct, clean, replenish, adjust or replace.

R - Replace or change.

(3)* Refer to "Recommended fluids and lubricants".

(4)* More frequent maintenance is required if the vehicle is operated under any of the following conditions:

- In heavy city traffic where the outside temperature regularly reaches 32°C (90°F) or higher, or
- In hilly or mountainous terrain, or
- When doing frequent trailer towing, or
- Uses such as found in taxi, police or delivery service.

(5)* Inspect and replenish every 30000 km (or 2 years)

Normal driving condition: Fill for Life

(Severe driving condition: Change every 120000 km)

(6)* If vehicle is operated under severe condition: Shorten the service interval.

- Towing a trailer or off-road driving (Inspect the leak of fluid at any time, occasionally)
- Taxi, patrol service or delivery service (extended idling and excessive driving with low speed)
- Frequent stop-and-go traffic, extended idling, short driving distance
- Driving in a hilly or mountainous terrain, sandy, or dusty area
- Driving frequently at high speed over 170 km/hour
- Driving frequently in area where heavy traffic under the ambient temperature above 32°C

Maintenance item	Maintenance interval	Kilometers (miles) or time in months, whichever comes first								
		x1000 km	7.5	15	22.5	30	37.5	45	52.5	60
		Months	6	12	18	24	30	36	42	48

Chassis and body

Tire condition & inflation pressure (7)*	Check frequently and adjust or replace if necessary								
Wheel alignment (7)*	Inspect when abnormal condition is noted								
Steering wheel & linkage	I	I	I	I	I	I	I	I	I
Outer ball joint inspection and replacement	I	I	I	I	I	R	I	I	I
Drive shaft boots (8)*	I	I	I	I	I	I	I	I	I
Seat belts, buckles & anchors	I	I	I	I	I	I	I	I	I
Lubricate locks, hinges & bonnet latch	Check frequently and adjust or replace if necessary								
Wheel bearing grease	I	I	I	I	I	I	I	I	I
Propeller shaft grease - Front / Rear (9)*	I	I	I	I	I	I	I	I	I
Air conditioner filter (10)*	R	R	R	R	R	R	R	R	R

Chart Symbols:

I - Inspect these items and their related parts. If necessary, correct, clean, replenish, adjust or replace.

R - Replace or change.

(7)* If necessary, rotate and balance wheels.

(8)* After completion of off-road operation, the drive shaft boots should be inspected.

(9)* Inspect propeller shaft grease every 5000 km or 3 months if the vehicle is mainly driven under severe condition.

- In off-road or dusty road, or

- In heavy city traffic where the outside temperature regularly reaches 32°C (90°F) or higher, or

- In hilly or mountainous terrain.

(10)* Severe Conditions in Air Conditioner Filter

- Pollutant area or off-road driving, extended air conditioner or heater operation

Checking the engine room

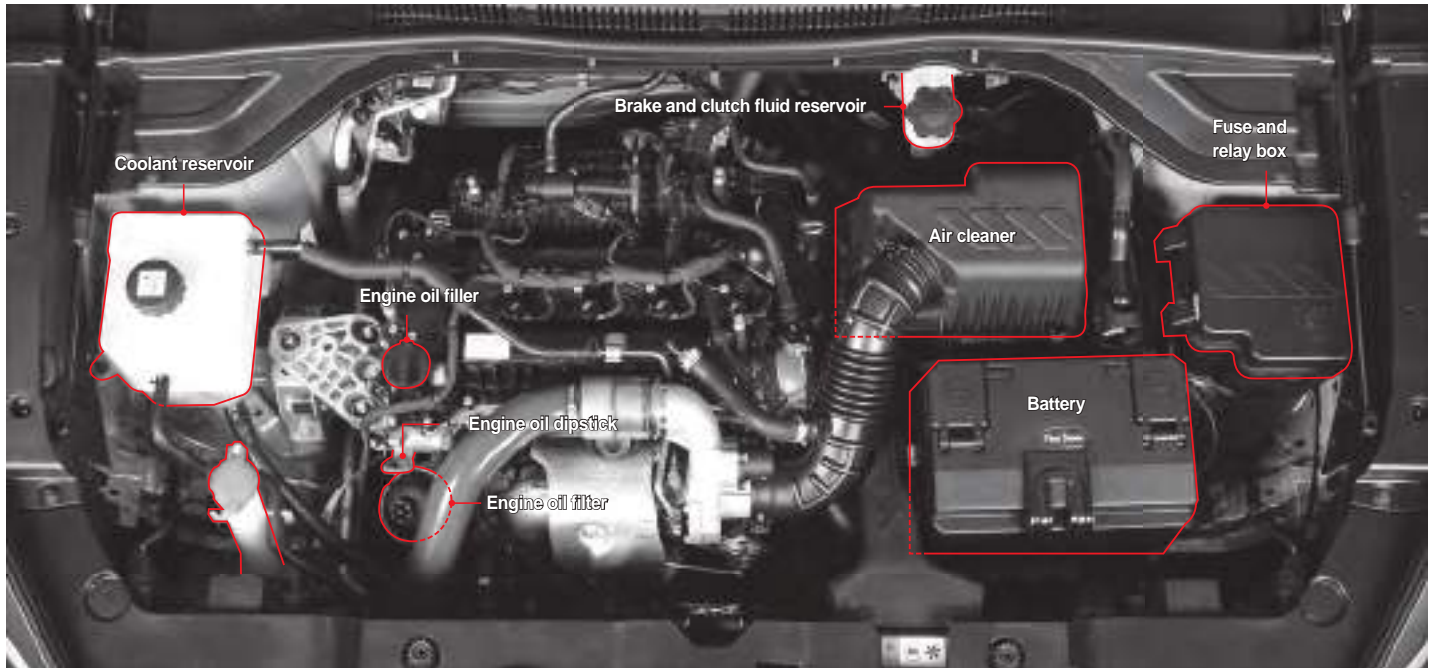

Warning

- After driving the vehicle, the systems including the engine, radiator, exhaust manifold, catalyst converter and exhaust pipe (muffler) are very hot, so caution should be taken when checking the engine room. Turn off and cool down the engine properly before checking in order to prevent a burn.
- There is a risk of serious injury from rotating parts such as the engine cooling fan when checking and working on the engine compartment. In addition, the cooling fan may rotate regardless of whether the engine is started or not.

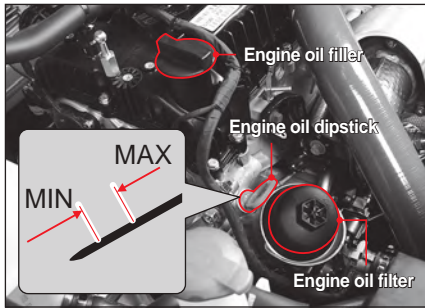

Level Check

Park the vehicle on a level ground and apply the parking brake.

Stop the engine and wait for more than 5 minutes.

- 1 Pull out the dipstick and wipe it out with a clean cloth. Reinsert it all the way.
- 2 Pull out it again and check the oil level.
- 3 The oil level should be between the maximum (Max) mark and minimum (Min) mark on the oil dipstick. Oil should be replenished before the level goes below the minimum mark.

Replenishment

- 1 If the level gets to the lower point, open the filter cap on top of the cylinder block and add the genuine oil without exceeding the level of the upper mark.
- 2 Recheck the oil level after 5 minutes.

Caution

- Regularly check the engine oil level and add KG Mobility genuine engine oil if necessary.
- Clean the dipstick with clean cloth so that any foreign materials cannot get into the engine.
- The oil should not go above the upper mark on the dipstick.
- The engine oil may be consumed more if the engine is new.

Warning

- Operating vehicle with insufficient amount of oil can damage the engine. Make sure the engine oil level is correct and add oil if necessary.

Function of engine oil

Engine oil's major function is to lubricate and cool the parts inside of the engine, which enables engine to work properly.

Consumption of Engine Oil

The consumption of engine oil is depending on the viscosity and quality of the oil, and the driving habit. More oil may be required under the following conditions;

- When the Vehicle is New

A new engine usually consumes more oil because its pistons, piston ring and cylinder walls are not yet adjusted with an optimal condition.

Oil Consumption : Max. 0.5 Liter per 1000 km

Accordingly, it is necessary for the driver to check frequently the oil level and to replenish oil if needed. KG Mobility Corporation recommends that the oil level be checked every time you refuel the vehicle or you drive the long distance until the first 5000 km.

- When driving at High Engine Speeds

As long as you keep the followings with sufficient care in your first running the vehicle, it will guarantee you to get excellent and comfortable performance for a long with your vehicle.

- Remember to check the engine oil level and shorten the cycle to refuel the engine oil under severe driving conditions.

- Avoid subjecting to engine to heavy loads by driving at full throttle, especially be careful when the outside temperature remains below freezing for the first 1000 km.
- Do not use the trailing in the first 1000 km driving

* What's Severe Driving Condition?

- Driving at the high engine speed or at high-speed
- Driving for consecutive two hours at high speed
- Driving the rough road, off-road, dirt-laden road, and muddy roads
- Driving in areas where salt or other corrosive materials are being used
- Repeated driving in short-distance
- Driving with the excessive idling
- High load driving such as trailing

Engine care

Observe the followings to keep the engine in good condition:

- Check the engine oil level frequently under severe driving condition and add some if necessary. The change interval should be shortened as well.
- Do not run a new engine at high speed until its driving distance gets 1000 km. Be extra careful when the engine is cold.
- After installing a new engine, do not tow another vehicle or a trailer until its driving distance gets 1000 km.

Change interval

- The engine oil filter element should be changed at the same time with the engine oil.
- Use only the KG Mobility genuine engine oil and filter.

Engine oil

Refer to Section "SCHEDULED MAINTENANCE SERVICES".

Engine oil filter

Service Interval

Same interval with the engine oil



Caution

- The service interval may be reduced if your vehicle is driven in rough conditions.
- Change the engine oil based on the driving distance or period, whichever comes first.

Specification and capacity

Service interval		
Specification	Gasoline	Quality class: KG Mobility genuine engine oil (Approved by ACEA C2 SAE 0W/30)
Capacity	G15DTF	4.5 l



Warning

- Use only KG Mobility genuine engine oil and filters. Use of nonrecommended products could cause damage to the engine.

Warnings and cautions when checking



Caution

- Regularly check the engine oil level and add the KG Mobility genuine engine oil if necessary.



Warning

- Clean the dipstick with a clean cloth so that any foreign materials cannot get into the engine.
- Use only the KG Mobility genuine engine oil.
- The oil should not go above the upper mark on the dipstick.
- Operating with insufficient or too much amount of oil can damage the engine.

SAE viscosity classes

The SAE classes (viscosity) should be selected in accordance with the average seasonal air temperature.

Applying the SAE classes exactly on the basis of the outside air temperatures would necessitate frequently changing the engine oil. The temperature limits for the SAE classes should therefore be regarded as reference temperatures and the actual air temperature may be higher or lower for a short period of time.

* How to check engine oil specification

Example:

0W, 5W, 10W, 15W, 20W, 25W **20, 30, 40, 50, 60**

Winter oil viscosity
(W: Winter)

Summer oil viscosity

- The numerical, for example SAE 10W, relates to viscosity at particular temperature and the alphabet "W" indicates the oil's suitability for colder temperature.
- For summer oil viscosity, higher numbers mean higher viscosities.

Notice

- **No separate washer fluid reservoir for the rear window is provided. The washer fluid is supplied from the washer fluid reservoir for the windshield.**

Engine

The viscosity should be selected according to outside temperature. Do not switch to a different viscosity in the event of brief temperature fluctuations.

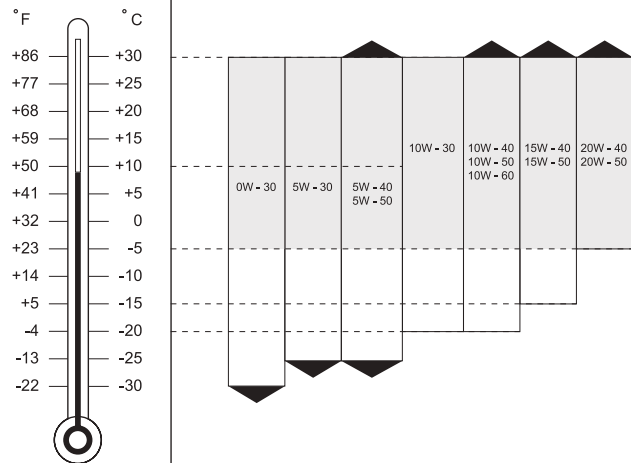

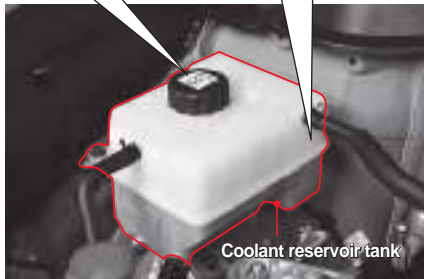
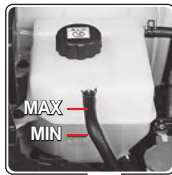

Level Check

Park the vehicle on level ground and apply the parking brake.
Stop the engine and wait until it cools.

- 1 The coolant level should be between the MAX and MIN mark on the coolant reservoir.
- 2 Check the coolant level. If the level is below the "MIN" mark, immediately add coolant.

Service Interval

- Replacement: Every 5 years or every 200000 km

Gasoline Engine (G15DTF)	7.0l	KG Mobility genuine coolant Anti-Freeze SYC-1025, Anti-Freeze:Water = 50:50 ORGANIC ACID TYPE, COLOR:BLUE
--------------------------	------	---

- Check: Everyday, before driving off
- Replenishment: Replenish as necessary

Warning

-  Do not remove the coolant reservoir cap when the engine and the radiator are hot. The cooling system may spray hot coolant if the cap is removed, causing serious injuries.
- Use only the KG Mobility genuine coolant.

Replenishment

Use only the 50/50 mixture of soft water and antifreeze as specified.

- 1 Open the coolant reservoir tank cap slowly when the engine is cold. At this time, you can hear a "hissing" sound.
- 2 When there is no more "hissing" sound, remove the cap from the reservoir tank.
- 3 Add the 50:50 mixture of water and antifreeze to the coolant reservoir tank.
- 4 If no unusual things happen, tighten the coolant reservoir cap.

Caution

- Avoid any direct contact of the coolant to the painted body of the vehicle.



Caution

- An incorrect coolant mixture can result in severe malfunction or engine damage.
- Do not use a solution that contains more than 60% antifreeze or less than 35% antifreeze, which would reduce the effectiveness of the solution.
- Check the antifreeze mixture ratio after adding or replacing the coolant.

Notice

- If in doubt about the mix ratio, a 50% water and 50% antifreeze mix is the easiest to mix together as it will be the same quantity of each. It is suitable to use for most temperature ranges of -36°C (-33°F) and higher.
- The antifreeze mixture ratio at the time of vehicle delivery is 45%.



Warning

- When the coolant level is too low, the engine can overheat. If the coolant temperature gauge in the instrument cluster goes up abnormally, immediately check the coolant level. Use only the KG Mobility genuine coolant. If different types of coolants or unapproved coolants are used to refill, chemical reactions can be caused and block the flow of the coolant. This may cause the engine to overheat or burning inside the engine.



Warning

- Scalding hot coolant and steam could be blown out under pressure, which could cause serious injury. Never remove the coolant reservoir tank cap when the engine and radiator are hot.
- Use only the KG Mobility genuine coolant.

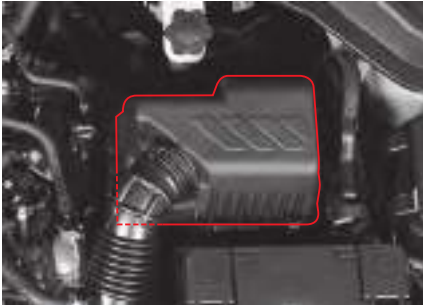

Cleaning

Refer to Section "SCHEDULED MAINTENANCE SERVICES".

Blow the compressed air through the element in the opposite direction to normal air flow to clean the element.

Caution

- If you blow the compressed air to normal air flow, the engine will be damaged due to foreign materials entering.
- Be careful with the direction of the compressed air on the air cleaner.

Caution

If vehicle is operated under severe condition

- Pollutant area or off-road driving
- Driving in dusty condition or sandy condition

frequently inspect the air cleaner, if necessary, change the air cleaner.

Warning

- Do not drive your vehicle with an improperly installed air cleaner element or without it. It may damage the engine or may cause a fire.
- Do not let any object enter the housing when cleaning the air cleaner. It may damage the engine or may cause an engine to stall.

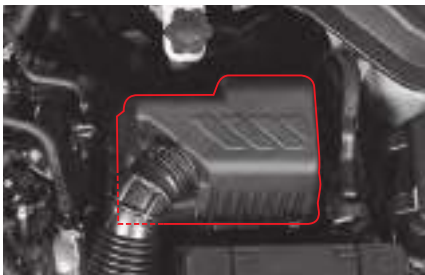

If the vehicle is operated in very dusty or sandy areas, replace more often than at the usual recommended intervals. If it is dirty, shake the element to remove dust. Clean the inside of the air cleaner housing and cover with a damp cloth.

Clean the air cleaner element by blowing compressed air through it in the opposite direction to normal air flow.



Warning

- Engine can be damaged.
- Do not operate the vehicle without air cleaner element.

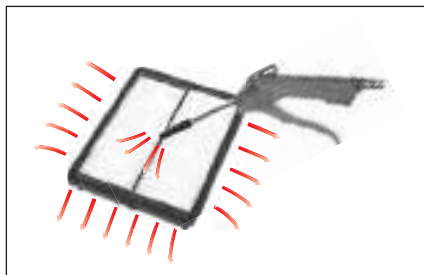

Blow the compressed air through the element in the opposite direction to normal air flow to clean the element as shown above.

Change

- 1 Open the clamp and remove the cover.
- 2 Replace the air cleaner element with a new one. Make sure that the element is correctly installed in the air cleaner housing.
- 3 Close the cover and close the clamp.

Brake and clutch fluid (with M/T)

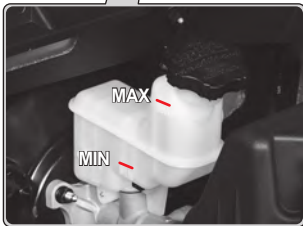
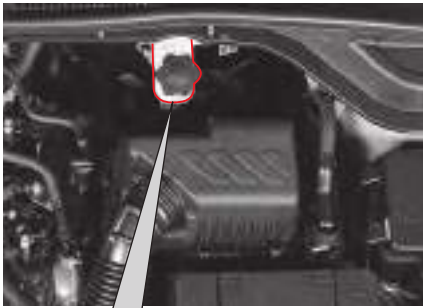

Specification and Replacement

Specification	DOT 4
Service interval	Every 2 years

Level Check and Replenishment

- The fluid level should be between the “MAX” and “MIN” levels on the reservoir.
- Check the level on a level surface. If it drops to or below the MIN mark, refill the tank with the specified fluid. Only use the specified fluid.

Caution

- Be careful not to let any foreign materials enter the tank when adding the fluid.
- Do not add the fluid above the “MAX” level.
- Do not allow the fluid to make contact with the body paintwork.
- After adding the fluid, tighten the cap securely.
- If frequent refills are required, have the system checked by a KG Mobility Dealer or KG Mobility Authorized Service Center.

Warning

- Use only the KG Mobility genuine brake fluid.
- Do not allow the fluid to make contact with skin or eyes. If contact happens, rinse affected areas immediately with plenty of water. If irritation persists, consult a doctor.
- The fluid gradually decreases according to brake pad wear. A sudden drop of the fluid level may indicate a leak in the system. In this case, have the system checked by a KG Mobility Dealer or KG Mobility Authorized Service Center.

Washer fluid

Top up washer fluid

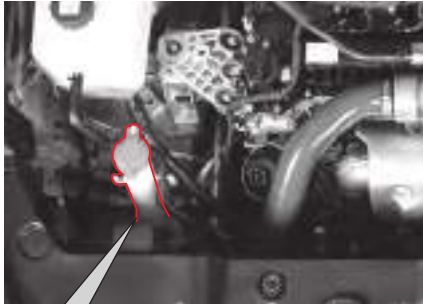

Frequently check the washer fluid level and add the specified product as needed.

In winter, use only the specified washer liquid for winter season.

Caution

- If you use plain water as washer fluid, it will freeze during the winter and damage the washer fluid reservoir and motor. Use only the specified washer fluid.
- If you operate the washer switch without washer fluid, the motor could be damaged due to overloads. Therefore, if there is no washer fluid, do not operate the washer motor.
- Operating the wipers on a dry surface on the windshield or rear window without any washer fluid may cause damage to the glass. Operate the wipers after sufficiently spraying the washer fluid.
- Avoid any spills of washer fluid on the engine or body paint of your vehicle during replenishment. If washer fluid spills onto your hand or other body part, wash it away under a clean water flow.
- There is no independent washer reservoir for the tailgate window. The front washer reservoir is also for the tailgate window.

Warning

- The washer fluid includes flammable materials to prevent freezing. It could cause a fire when directly contacted with flames. When checking the washer fluid, avoid the flames near the washer fluid tank.
- If engine oil or antifreeze is used as the washer fluid, it will decrease your visibility through the windshield and may cause an accident.

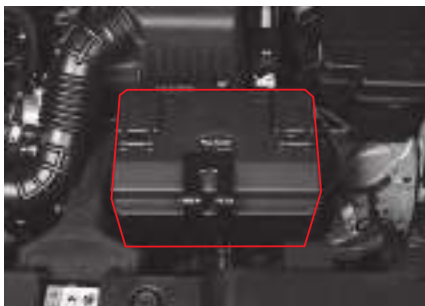

When the battery charge warning light (⚡) on the instrument cluster comes on, the battery is not normally charging. If the warning light comes on while driving, turn off all unnecessary electrical devices and have the system checked by a KG Mobility Dealer or KG Mobility Authorized Service Center.

Battery Maintenance

- Make sure the terminal connections are securely tightened.
- If the terminals are corroded, clean them with a wire brush or sand paper.
- The battery terminal should be disconnected only when the ignition key is removed from the key cylinder. Disconnecting the terminal with the key in the “ON” or “ACC” position may cause a sudden change in voltage and damage various electrical systems.
- Check the battery for any cracks, damages or leaks. Replace it if necessary. To remove any battery fluid on the battery surface, wear rubber gloves and wipe the fluid out with a wet-soapy cloth.

Specification

	Non-ISG	ISG
Specification	MF / 12V - 60AH	AGM / 12V - 70AH
Capacity	60AH	70AH

Caution

- If you disconnect the battery terminal when the engine is running, electrical systems could be damaged.
- To remove the battery cable, disconnect the negative cable first and be careful on the battery terminal polarity when you connect the cables. The negative and the positive should not be confused.
- The polarity of the battery, i.e. the connections for positive and negative cables, must not be interchanged. Never short-circuit the battery.
- When the ambient temperature is too low, the battery capacity will drop and can be frozen.
- Keep the battery electrolyte at its specified level. If the electrolyte level is higher than the MAX level, it can overflow during battery charging and if the electrolyte is overcharged, the battery can explode.
- Only use a battery with the approved voltage and capacity. Otherwise, an incompatible battery can catch fire.







Warning

- The battery has acid that can burn you. And its gas can explode. You can get serious injuries if you are not careful. Keep naked flames, sparks and smoking items away from the battery.
- Loosely connected batter terminals can set up sparks. These sparks can cause a fire with flammable gas. Therefore, tightly connect the terminals.
- At night, if you need to check the engine room, do not use a lighter, but only use a battery-powered flashlight.
- Because the battery electrolyte is very strong acid, avoid any direct contact of the battery electrolyte on your skin or vehicle's body. If the acid contacts your skin, thoroughly wash your skin with fresh water and see your doctor. Do the same on your vehicle.
- Wear eye protection when working with a battery. If working in a closed area, keep good ventilation.



Warning

- Always use the battery with correct voltage for the vehicle. Otherwise, there is a risk of fire.
- Observe the indications on the battery.
 -  Always read the safety instructions in the User Manual before working on the battery.
 -  The battery cell always contains highly flammable hydrogen gas which may explode if ignited. Be sure to keep it away from a cigarette, a spark or other flames.
 -  Wear a protective goggle when charging the battery or performing any work. In addition, ensure adequate ventilation of the enclosed space.
 -  The battery electrolyte solution contains a highly corrosive sulfuric acid. Be careful not to contact it with skin, eyes, clothes or paint. In particular, keep out of the children's reach.



When in contact with the skin, wash off the contact area; In case of eye contact, flush with running water for at least 15 minutes, and seek medical help immediately.



The hydrogen gas in the battery is highly flammable and may explode if ignited.



Do not throw out used battery as this pollutes the environment and is hazardous to our health. For environmental protection, used, properly dispose of used battery at designated disposal sites only.

- To check the battery and engine compartment in the night, always use flash light and never use the lighter or etc.

Spark plugs - Gasoline engine



Spark plugs should be inspected periodically for carbon deposits. When carbon accumulates on a spark plug, a strong spark may not be produced. Do not clean the electrodes with a fine wire brush and carefully scrape the carbon off the insulator with a small file. The spark plugs should then be blown clean with compressed air and the upper insulator wiped clean. Do not adjust the spark plug gap.

Service Interval

Replacement	Change every 60,000 km	
Specification	FM	RER6WYPB
	Gap	0.7 ~ 0.8 mm



Caution

- When replacing the spark plugs, **disconnect the negative terminal of the battery and turn off all the switches.**
- It is recommended that the engine be cool or cold when changing the spark plugs (you could burn yourself).
- Do not use non-recommended spark plugs.
- Do not allow contaminants to enter spark plug hole.



Warning

- Spark plugs may be very hot. Be careful not to burn yourself.

Checking the wipers and replacing the blade

Replacing the blade of windshield wiper

- 1 Lift the wiper arm up with the engine turned off.

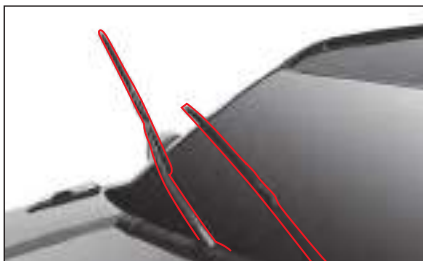

- 2 Press the wiper blade retainer (1) and pull the wiper blade out in the arrow direction (2).

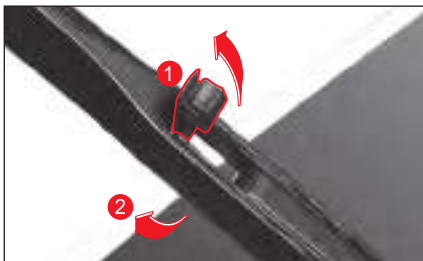

- 3 Insert a new wiper blade.
- 4 Put the wiper arm down.

Replacing the blade of rear window wiper

- 1 Lift the wiper arm up with the engine turned off.

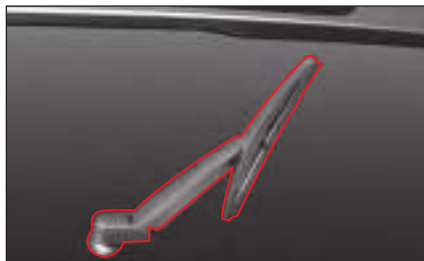

- 2 With the wiper blade lifted to its side, remove it by pulling it in the arrow direction.



- 3 Insert a new wiper blade until a clicking sound occurs.
- 4 Put the wiper arm down.

Specifications of wiper blade

Windshield wiper		Rear window wiper
Driver seat side	Front passenger seat side	
600mm	450mm	250mm
24 "	18 "	10 "

Warning

- If there is a problem in wiper operation, it can be a fatal obstacle to safe driving when it rains or snows. Never drive the vehicle on a snowy day or a rainy day if the wiper does not operate.
- Holding the wiper arm or placing your hand near the operating part when the wiper is operating may cause an injury.



Caution

- Do not open the engine hood with the wiper lifted up. Doing so may damage the engine hood and the wiper.
- Do not operate the wiper when the windshield is dry.
- Do not wipe the windshield or the rear window with a towel stained with oil or wax. If the windshield or the rear window is stained with oil or wax, an abnormal noise may occur when you operate the wiper or light is reflected at night, making you unable to see the front well.
- When you check the wipers, be sure to lift the driver seat side wiper arm up first and then lift the front passenger seat side wiper arm up.
- When you lift the driver seat side wiper arm up, it may interfere with the front passenger seat side wiper arm, but that is normal.

Checking and replacing fuses and relays

If an electrical system does not operate normally, check the relevant fuse first. If the fuse is blown, replace it with a fuse of the same capacity.

Warning

- Not using a bulb or using a bulb with the capacity that does not meet the specifications or modifying the HID bulb or LED lamp wiring arbitrarily may cause the fuse disconnection, malfunction or damage other wiring-related devices.

Caution

- Removing a fuse while the electricity is being supplied may damage the relevant electrical system. Be sure to replace a fuse after turning off all electrical systems and the engine.
- Replace the fuse with a new one of the same capacity that meets the specifications.
- If the replaced fuse is blown continuously, have your vehicle checked and serviced at a KG Mobility Authorized Service Center.

Notice

- Refer to the label attached to the fuse and relay box cover for the capacity and name of fuse.

Engine compartment fuse and relay box

Open the engine hood and lift the fuse box cover up with the locking lever (1) in front of the engine room compartment fuse box cover pressed.

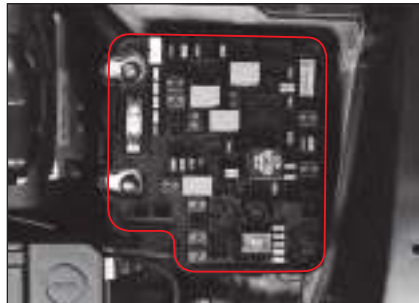
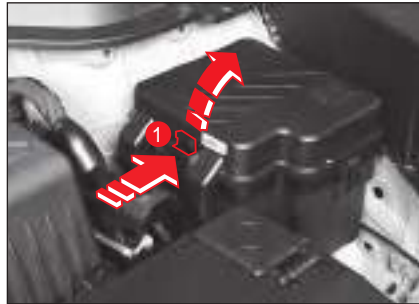

Interior fuse box

Open the driver seat door and open the interior fuse box by inserting your finger on the groove of the interior fuse box cover (1) and pulling it.

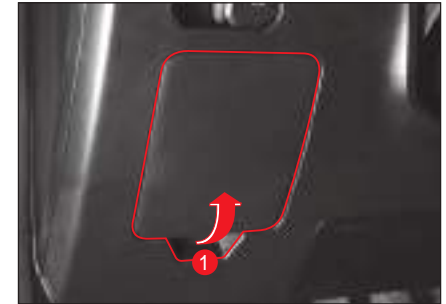

Checking and replacing fuses

- 1 Turn off all electrical systems and the engine.
- 2 Open the cover of the engine compartment fuse box cover or the interior fuse box.
- 3 Check the relevant fuse by referring to the block diagram of the fuses shown inside of the fuse box cover.
- 4 Pull out the relevant fuse by using the fuse puller.
The fuse puller is provided in the engine compartment fuse box.

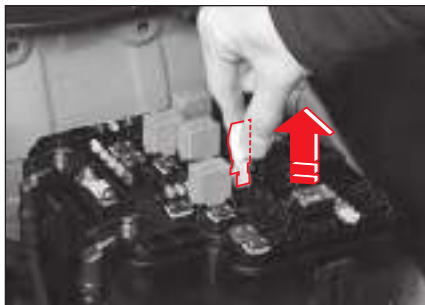

- 5 Check visually whether the fuse is blown or not.
- 6 If the fuse is normal, insert it back to its original position.
- 7 If the fuse is blown, check the capacity indicated on top of the fuse and replace it with a new fuse of the same capacity.

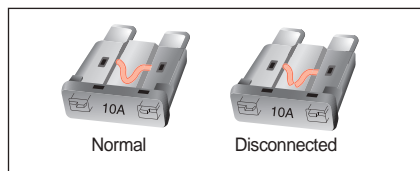
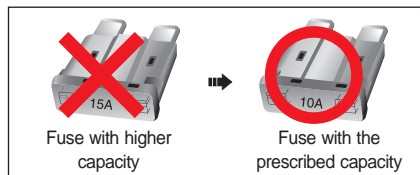

Warning

- Using steel wire, copper wire or aluminum foil instead of the fuse may cause a fire due to the overload of the electrical system. Always use a fuse with the prescribed capacity.
- Never use a fuse with a capacity higher than the prescribed capacity indicated on the fuse and relay box since a fuse with higher capacity may damage electrical systems or cause a fire.
- When the fuse is disconnected, use a normal fuse with the prescribed capacity.

Notice

- Spare fuses for each capacity are provided in the fuse and relay box. If you use a spare fuse, replenish with a new one immediately. The capacity is indicated on top of the fuse.

Checking and replacing the lamps

Specifications of lamps and checking

Specifications and quantity of lamps and bulbs

Classification		Quantity	Specifications
Exterior lamp (front side of the vehicle)	Head lamp	High beam	- LED
		Low beam	- LED
		Sidelight/daytime running light (DRL)	- LED
		Turn signal	- LED
	Front fog light	- LED	
	Side repeater	- LED	
	Exterior lamp (rear side of the vehicle)	Rear lamp	Stop lamp
Tail light/Stop lamp			- LED
Backup lamp			2 W16W
Turn signal			2 PY21W
License plate lamp		2 W5W	
High mounted stop lamp		- LED	
Rear fog lamp		- LED	

Classification		Quantity	Specifications
Interior lamp	Front room lamp	LED	- LED
		Bulb	2 10W
	Center room lamp	LED	- LED
		Bulb	2 8W
	Luggage room lamp	LED	- LED
		Bulb	1 5W
	Sun visor/mirror lamp	2 5W	
	Glove box lamp	1 5W	
	Dashboard mood lamp (front passenger seat side)	- LED	
	Front door mood lamp	- LED	

Checking the lamps

Operate the ON/OFF switch of various lamps to see if the lamp turns on or off normally.

If the lamp does not turn on, check the lamp in the following order and replace the relevant part if it is abnormal.

- Fuse
- Bulb

If the fuse and the bulb are normal, have your vehicle checked and serviced at a KG Mobility Authorized Service Center.

Headlamp desiccant*

A consumable desiccant is included in the headlamp (high beam/ low beam / turn signal / side lamp and daytime running lamp) to mitigate fogging due to moisture. An inside fogging problem lasts for a longer period of time, have the system checked and serviced by a KG Mobility Authorized Service Center.



Caution

- Only use a bulb with the prescribed capacity when replacing the lamp.
- Be sure to disconnect the negative (-) battery cable or turn off the engine before replacing the lamp.
- Removing the lamp cover forcibly may damage the lamp cover so that it may not be used again, so caution should be taken when removing the lamp cover.
- Before replacing a bulb, be sure to turn off the relevant lamp and the engine.
- Do not touch the bulb with your hands during or right after bulb operation since there is a possibility of a burn.
- Holding the glass part of the bulb with your hand may leave a fingerprint, dust or moisture on the bulb, reducing its life or exploding it. In such case, wipe the glass part with a soft cloth.
- Be sure to have the aiming angle of the head lamp adjusted by a KG Mobility Authorized Service Center.
- The internal surface of the head light and braking light lamp may be fogged temporarily under conditions such as rain or car washing. This is dew condensation according to a temperature difference between the inside and the outside of the lamp and it is not a functional problem. However, if water enters into the lamp or a large water drop occurs inside the lamp, contact a KG Mobility Authorized Service Center.

- To replace an exterior lamp bulb, visit a KG Mobility Authorized Service Center.
- Only use appropriate tools and bulb of specified capacity when replacing different lamps. If you do not have a bulb available or are not familiar with how to replace it, please visit our nearest KG Mobility Authorized Service Center for service.
- Be sure to replace it with a new lamp (same capacity and color) that fits the lamp type. Failure to do so may result in a blown fuse or lamps malfunction and damage (open circuit / short circuit / fire) to other wiring related devices.
- Fingerprint, dust, or moisture stuck to bulb may shorten a bulb life or cause a bulb bursting. In this case, wipe the bulb glass with a soft cloth.
- If the inside of the lamp is damp, it is removed by driving the vehicle after the lamp is turned on, and the level of moisture removal may vary depending on the conditions of the lamp (size / position / environment, etc.). If moisture is not constantly removed, have your vehicle checked and serviced at a nearest KG Mobility Authorized Service Center.

Position of exterior lights and lamps

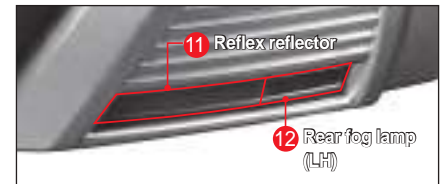
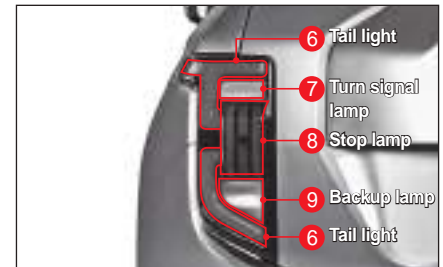
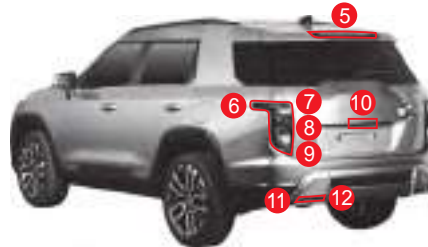
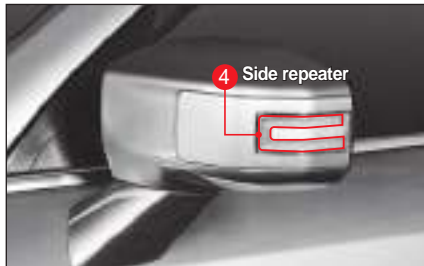
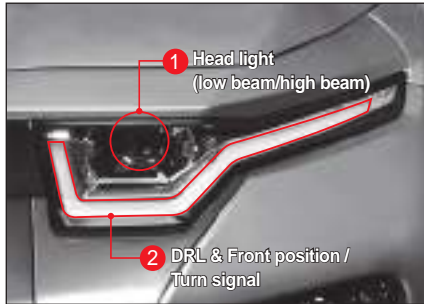

Replacing exterior lamps

All lamps except for the following lamps should be checked and replaced at a nearby KG Mobility Authorized Service Center.

- Rear turn signal lamp
- Backup lamp



Warning

- Replacing with a lamp that does not meet the specifications may cause the disconnection of a fuse, malfunction or a fire.
- Before replacing the lamp, park the vehicle at a safe place, turn off the engine and disconnect the negative (-) battery cable. (After connecting the battery again, reset some functions of the vehicle.)
- Do not touch the bulb with your hands during or right after bulb operation since there is a possibility of a burn.



Caution

- When you install the lamp again after replacing it, install the socket firmly to the hole by turning it clockwise.
- Be sure to use genuine parts for the lamp.
- Do not install an additional lamp or LED for the lamps installed previously on the vehicle.

Replacement of headlamp desiccant

If the headlamp condensation problem persists, please replace the desiccants.



Headlamp absorbent*

A consumable desiccant is included in the headlamp (high beam/ low beam / turn signal / side lamp and daytime running lamp) to mitigate fogging due to moisture. An inside fogging problem lasts for a longer period of time, have the system checked and serviced by a KG Mobility Authorized Service Center.

To replace license plate lamp

- 1 Unscrew the license plate mounting screws.



- 2 Remove the license plate assembly.



Caution

- Be careful not to damage the vehicle body and the rear combination assembly.

- 3 Turn the license plate assembly clockwise to remove the bulb socket.



- 4 Remove the license plate from the socket and replace it with new one with right specifications.



- 5 Once replacement is completed, assemble the lamp in reverse order of removal.

To Replace Rear Combination Lamp

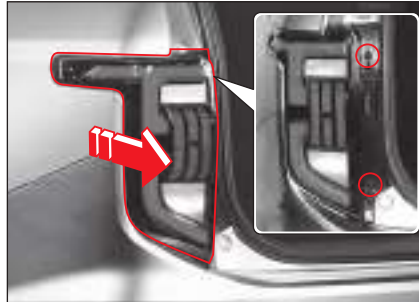

- 1 Disconnect the battery (-) terminal and remove the two mounting screws for the rear combination lamp. Pull the lamp assembly in the direction indicated by the arrow in the picture to disconnect the connector and detach the lamp.

! Caution

- Be careful not to damage the painted surface of the vehicle body or rear combination assembly when removing it.

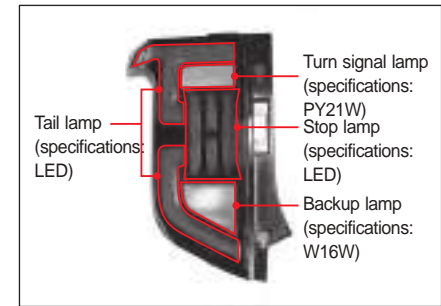

- 2 Turn the turn signal lamp socket counterclockwise to remove it.

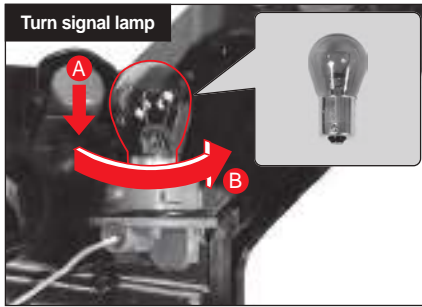

- 3 Remove the lamp from the removed socket by rotating the lamp in the direction of the arrow (B) while pressing it in the direction of the arrow (A).
- 4 Install in the reverse order of removal.

- 5 Turn the backup lamp socket counterclockwise to remove the it.

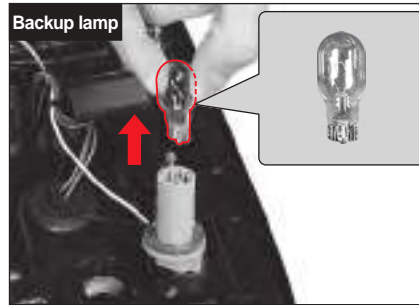

- 6 Pull out the lamp in the direction of the arrow from the removed socket.
- 7 Install in the reverse order of removal.

Position of interior lamps

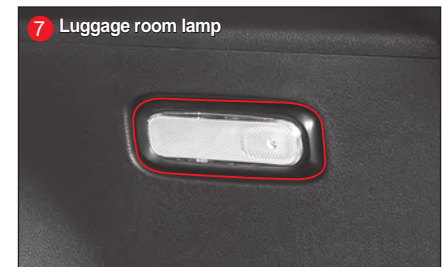
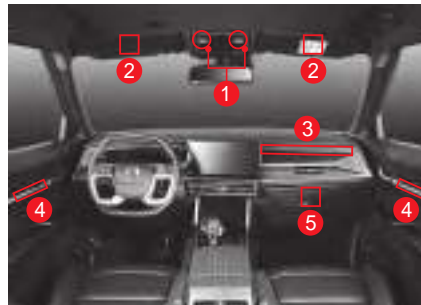
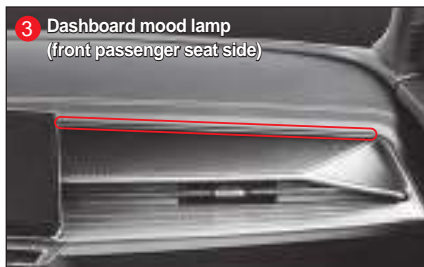
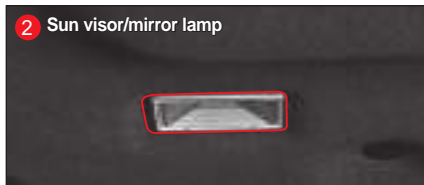
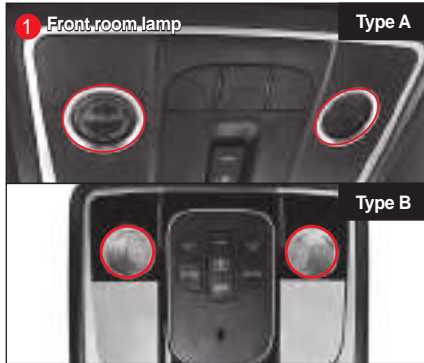

Replacing the interior lamps

Center Room Lamp (Bulb)



- 1 Turn the room lamp switch OFF, and remove the cover using a flat bladed screwdriver.

Caution

- When removing the cover, make sure to remove the front part of the cover first (marked with arrows). If you remove the rear part of the cover first, the cover may be damaged.



- 2 Remove the lamp by pulling it down (arrow direction) and replace it with a new one.
- 3 Fit the cover.

Replacing the sun visor/mirror lamp (Bulb)

- 1 Turn off the engine and remove the lamp cover using a flat bladed screwdriver.

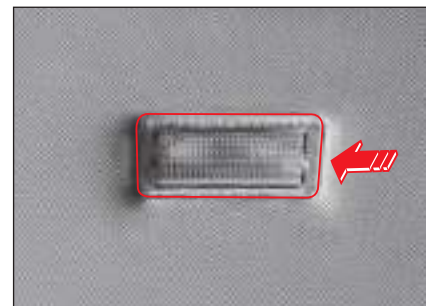

Caution

- Be sure to remove the lamp cover from the part marked with an arrow first. Removing it from the part on the opposite side first may damage the connector and the cover.

- 2 Remove the lamp and replace it with a new one.

At this time, avoid leaving a fingerprint or a foreign material on the surface of the bulb.

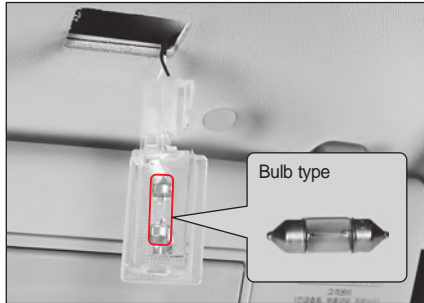

- 3 After replacing it, install the cover again.

Glove Box Lamp

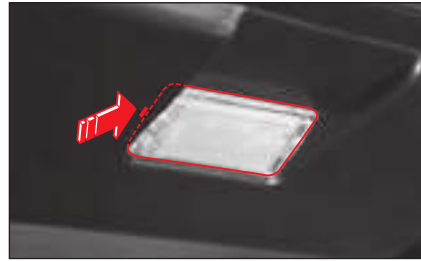

- 1 Disconnect the negative battery cable and remove the cover using a flat bladed screwdriver.

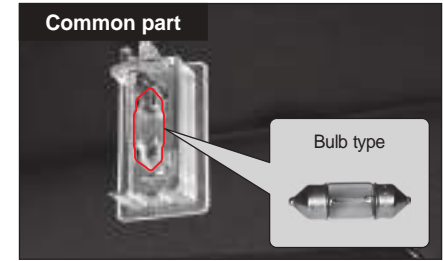

- 2 Remove the lamp.
- 3 Replace the bulb with a new one. Keep the surface of the bulb free of finger print for foreign matter.
- 4 Fit the cover.

Caution

- When removing the cover (sun visor lamp, glovebox lamp, driver/passenger lamp), remove the part with arrow mark first. Otherwise, the cover and connectors can be damaged.

Replacing the A/C filter

In any of the following cases, replace the A/C filter even if the replacement interval has not come near.

- If an unpleasant smell comes out when you operate the A/C after it is not operated for a long period of time
- If the cooling and heating performance or air blowing performance is lowered



Caution

- Replace the A/C filter every 15,000 km. However, if the vehicle is driven on a road where the air is heavily polluted, an unpaved road or the A/C and the heater are used excessively, replace the A/C filter earlier than the replacement interval.
- If the A/C filter is contaminated, the cooling performance may be lowered and an unpleasant smell may occur when you operate the A/C.
- Be careful not to switch the installation direction when replacing the A/C filter.

- 1 Open the glove box by pulling the glove box opening lever.

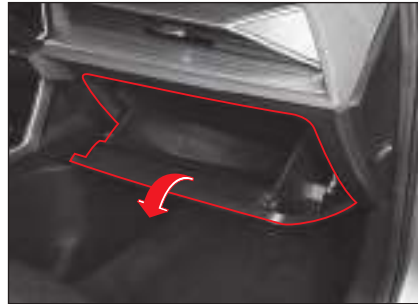

- 2 Pull the fixing holder on the left side and the right side of the glove box in the arrow direction.

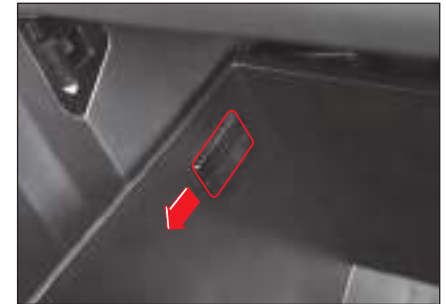

Caution

- Do not pull the fixing holder of the glove box forcibly. Doing so may cause the fixing holder to deform, and the fixing status of the glove box may be loose when it is installed again.

- 3 Separate the glove box damper clip from the bottom right side of the glove box.

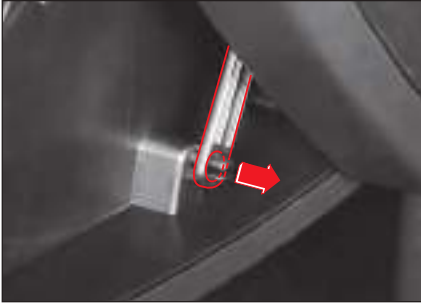

- 4 Remove the A/C filter cover by pressing the right side of the A/C filter cover.

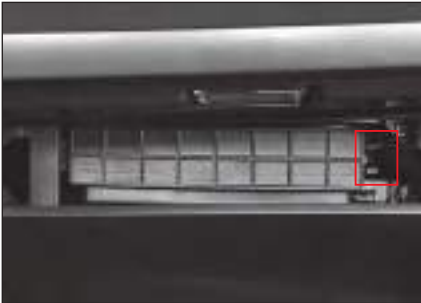

- 5 Remove the A/C filter.

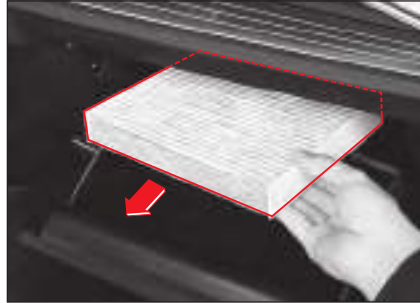

- 6 Replace it with a new one.
Install it with the "AIR FLOW arrow" facing down.

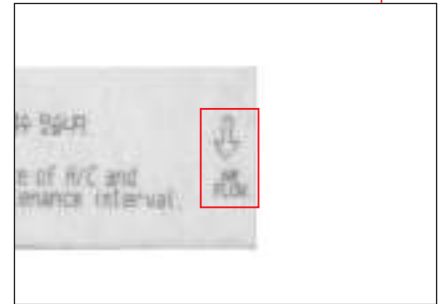
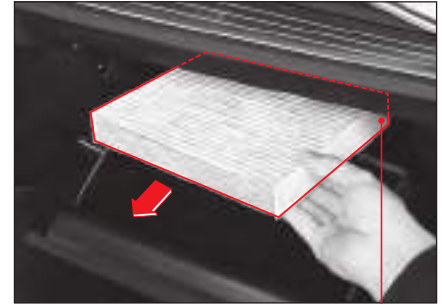

- 7 After replacing it, install it in the reverse order of A/C filter removal.

Checking the tires and wheels

Checking the tire pressure

Check the tire pressure before driving the vehicle or when the tires are cooled down completely.

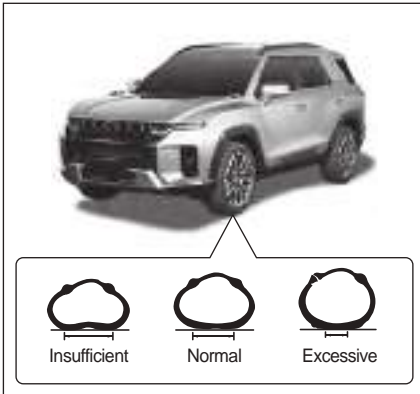

Caution

- If the tire pressure is higher or lower than the prescribed value, the riding comfort or steering stability are lowered and the tires are easily damaged and uneven tire wear occurs. Be sure to adjust the tire pressure to the prescribed value.

Prescribed tire inflation pressure

Classification	Type	Wheel	Tire pressure
Driving tire	225/60R17	6.5JX17	34 psi, (2.3 bar)
	235/55R18	7.5JX18	
	245/45R20	8.0JX20	

Notice

- The prescribed tire inflation pressure is measured when the tire has been cooled down properly at room temperature. If you need to drive the vehicle on an expressway for a long period of time, increase the tire inflation pressure by 4–5psi from the prescribed value on the table.

Wheel alignment status and the balance between tires and wheels

If the wheels are not aligned as prescribed, it leads to uneven or accelerated wear of the tires and causes the vehicle to lead to one side while driving.

If the tires and wheels are not balanced, it may lead to vehicle vibration or uneven wear of tires.

In such case, have your vehicle checked and maintained at a KG Mobility Authorized Service Center.

Checking the status of tire wear

Check the status of tire wear on the contact surface of the tire along the marked part. Replace the tire before the tire tread goes down below the wear limit.



Warning

- Check the tire for damage or the status of tire wear frequently and replace if necessary.
- If the tire is worn excessively, the braking distance may increase or the steering wheel may become heavier. Also, the tire may be blown, resulting in an accident.

Rotating the tire positions

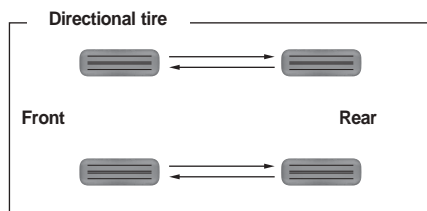
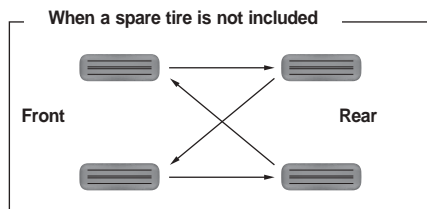

☞ Refer to "When you have rotated the tires" (p.2-33)

Warning

- Be sure to replace a tire at a KG Mobility Authorized Service Center or a professional tire shop.
- Be sure to install the same manufacturer's tires with the same specifications, not mixing different types of tires.

Snow tire

Use snow tires in order to drive the vehicle safely on a snowy road or an icy road during winter.

The snow tires should be installed on all 4 wheels.

Warning

- If the snow tires for driving on a snowy road and an icy road are not installed, drive the vehicle as slowly as possible.
- The snow tire with the driving direction arrow on its side wall should be installed according to the driving direction.
- The snow tire is manufactured in consideration of the characteristics of road surface during winter. However, it is an auxiliary aid, so be sure to install the snow chains on a snowy road and an icy road and drive the vehicle as slowly as possible for safe driving.
- Replace the snow tires with ordinary tires when the winter has passed. Store the snow tires in a cool place with no direct sunlight and be careful not to allow them to come into contact with oil, grease or fuel.

Tire chain

- Install the tire chains on the rear wheels for a 2-wheel drive vehicle and install the tire chains on both the front and rear wheels for a 4-wheel drive vehicle. If it is impossible, be sure to install the tire chains on the rear wheels.
- In case of a vehicle equipped with aluminum wheels, the wheels may be damaged if the tire chains are used. Therefore, use snow tires instead of the tire chains. If it is impossible, use the wire-type tire chains.
- When the tire chains are installed, drive the vehicle at a prescribed speed recommended by the chain manufacturer or at a speed of 30 km/h or less.
- If you hear a sound of the tire chain hitting the vehicle body, stop the vehicle immediately, check the installation status of the tire chains and tighten the tire chains if necessary.
- Take the tire chains off immediately on a normal road to prevent the chains from being damaged.
- Do not use the tire chains on a normal road, use only on a snowy road or an icy road.



Warning

- **After driving the vehicle with the tire chains installed for a certain distance (0.5~1 km), check the installation status of the tire chains and for any damage to the vehicle body. If the tire chains are loose, tighten them again.**
- **Be sure to use a tire chain that meets the specifications and install it correctly. If the tire chain does not meet the specifications or is installed incorrectly, the vehicle may be damaged or a serious problem in the steerability and safety of the vehicle may occur.**

Cautions for checking the tires and wheels



Caution

- **Be sure to use the same manufacturer's tire with the same specifications for all tires in order to maintain the characteristic of the vehicle safely.**
- **Be sure to check the status of tire wear and the tire pressure before driving the vehicle.**
- **The tire pressure and tightening status of tire wheel nuts should be checked frequently. Be sure to check the vehicle condition, tire pressure and the tightening status of tire wheel nuts before driving the vehicle for a long distance.**
- **Only use the same manufacturer's tires that meet the specifications. If the tire that does not meet the specifications when installed, you cannot operate the steering wheel normally, the fuel consumption may increase and the driving system or braking system of the vehicle may become abnormal. In addition, the vibration of the steering wheel and uneven tire wear may occur when you drive the vehicle at a high speed.**
- **Installing a tire that does not meet the specifications or a retreaded tire voids the warranty repair.**

- Check the tires and wheels always before driving the vehicle. If the wheels are damaged, the tire pressure may decrease and the tires may be damaged.
- If a tire has been impacted by a stone or any other objects while driving, have your vehicle checked and serviced at a KG Mobility Authorized Service Center immediately.
- Do not mix the tires and wheels installed when the vehicle was shipped with other tires and wheels. Doing so may affect the driving stability of the vehicle, causing an accident.
- Check the status of the emergency tire service kit. Always check the operation status of the compressor and the preparation of sealant.
- Be sure to check and add the tire pressure before driving the vehicle for a long period of time or at a high speed. Driving the vehicle at a high speed with low tire pressure may cause the tires to burst due to the standing wave effect, resulting in a risk such as a rollover.

Vehicle management during winter

Various unfit elements for driving occur on a road in winter, so make sure to prepare in advance in order to respond properly.

Starting the engine and driving the vehicle

During winter, the resistance of the power train in the engine increases and the performance of the battery and the starting motor is lowered so that the engine may not be started smoothly. Start the engine in a proper way.

After starting the engine, allow enough time to warm it up before driving the vehicle. It will increase the engine's life expectancy and ensure smooth driving.



Caution

- Replace the engine oil and the fuel filter according to their replacement intervals. A decrease in flowability and the clogging of the fuel filter and the oil filter due to the contamination of engine oil may become an obstacle to starting the engine in winter.
- Do not add additives such as white kerosene or alcohol besides the genuine fuel arbitrarily in order to improve the startability. Doing so may damage the engine and relevant parts or cause excessive exhaust gas emission due to inadequate lubrication of important parts inside of the fuel system and different characteristics such as flash point.
- Be sure to preheat a diesel-powered vehicle before starting the engine.

Managing the engine oil

This vehicle is shipped after it is filled with 4-season engine oil. If the replacement interval has not come, you do not need to change the engine oil.

Managing the engine coolant

Be sure to check the concentration of coolant before the temperature begins to drop.

Normal concentration of coolant is a mixture of water and antifreeze at the ratio of 50:50.

If only water has been added to the vehicle without antifreeze when replenishing the coolant, the coolant may freeze, damaging the engine and the cooling system seriously when the temperature drops below 0°C.



Caution

- When adding or replacing the coolant, be sure to use a mixture of water and antifreeze at the ratio of 50:50.
- Use only the KG Mobility genuine antifreeze for the coolant.

Notice

- This vehicle is shipped after it is filled with 4-season antifreeze.

Managing washer fluid

Use only genuine washer fluid that does not freeze in cold weather.

If the washer fluid freezes due to the use of a non-standard washer fluid it may damage the washer motor and interfere with safe driving.

Installing a snow tire

It is recommended to replace the tires with snow tires during winter in order to prevent the vehicle from slipping on a snowy road or an icy road.



Caution

- Drive the vehicle at a lower speed than usual if the snow tires are installed.
- Install the tire chains in a correct way. Failure to do so may damage the wheel house or the vehicle body.

Managing the A/C

If the A/C is not used for a long period of time, the lubrication inside the A/C is not carried out. As a result, the packing inside of the A/C may be hardened that may lead to refrigerant leak and malfunction due to rusting.

It is recommended to operate the A/C for 5 to 10 minutes once a week regardless of season in order to maintain the performance of the A/C continuously.



Caution

- Do not remove the refrigerant in winter even if the A/C is not used.

Other maintenance

- Prepare sand bags, snow chains, shovel, gloves and old clothes in the vehicle in advance in preparation for driving the vehicle in the countryside or heavy snow.
 - Do not drive too fast, accelerate or brake or steer the vehicle suddenly on a snowy road or an icy road.
 - When you drive the vehicle on a snowy road or an icy road, keep a safe distance twice as long as usual from a preceding vehicle and downshift to use the engine brake effect properly when you stop the vehicle.
 - Do not operate the wiper when it is frozen. Doing so may overload, damaging the wiper motor.
 - When you drive the vehicle on a snow-covered road, a large amount of snow may build up under the wheel house, making it difficult for you to operate the steering wheel, so check and remove it frequently.
 - When you have passed a road where calcium chloride is sprayed, wash your vehicle as soon as possible to prevent the bottom part of the vehicle from being corroded.
- If you park the vehicle in a snowy place, the brake system may freeze, reducing the braking force while driving. In such case, depress the brake pedal frequently while driving the vehicle at a low speed, restoring the braking force, and then drive the vehicle normally.
 - Do not start off in the vehicle forcibly while the parking brake is frozen. Doing so may damage the vehicle. Be sure to start off in the vehicle after the parking brake has melted.

Cautions for parking during winter

- When the temperature falls down below zero, the parking brake may not be released due to the freezing of EPB-related devices.
- When you park the vehicle on a flat and safe place in weather with below zero temperatures, use a chock on the wheels after parking instead of using the EPB.
- If the vehicle is parked/stopped while idling for a long time after starting the engine in cold weather, the water vapor in the exhaust gas condenses and accumulates inside the exhaust pipe. The accumulation of water inside the exhaust pipe can cause noise. However, it is discharged during medium- and high-speed driving.
- When you park the vehicle in weather with below zero temperatures, moisture remaining in the exhaust pipe might have frozen. This is a normal state of the vehicle. Do not depress the accelerator pedal or idle the engine for a long period of time in order to remove frozen moisture.

Warnings for self-maintenance

When the vehicle is checked and serviced by the driver, proper knowledge and special attention are necessary for preventing injury and damage to the vehicle.



Warning

- After driving the vehicle, the systems including the engine, radiator, exhaust manifold, catalyst converter and exhaust pipe (muffler) are very hot, so caution should be taken when checking the engine room. Turn off and cool down the engine properly before checking in order to prevent a burn.
- Be sure to turn off the engine, place the gear shift lever in the P (parking) position and apply the parking brake when checking the vehicle.
- Be sure to turn off the engine when checking the vehicle in a garage or a poorly ventilated space.
- Do not smoke when checking the battery, fuel-related parts or the washer fluid. Do not check the battery, fuel-related parts or the washer fluid in a place where flames or sparks occur easily.
- Do not connect or disconnect the battery when the START/STOP switch is in the ON position.
- When you connect battery cables, be careful not to switch the positive and negative cables.

- The battery cables and the wires in the vehicle transfer high current and voltage. Be careful of a short circuit.
- Keep the used oils, coolant and other fluids out of children's reach.
(Ask a professional company for disposal.)
- The cooling fan may spin even if the engine is not running. Separate the negative battery cable when you check the vehicle near the cooling fan or the radiator.
- Check the level of various oils and coolant daily. Driving the vehicle with insufficient oils or coolant may damage the vehicle which is not subject to warranty repair.
- Be sure to use genuine parts for replacing consumable parts.
- When you add any oil or coolant, be careful for the oil or coolant not to come into contact with your body, clothes or the painted surface of the vehicle. If it comes into contact with your body, wash it off immediately and consult your doctor.
- Adding more oil or coolant than the prescribed level may damage the systems. Always add a proper amount of oil or coolant.
- When you inject or add any oil or fluid, do not allow foreign materials such as moisture or dust to enter. Failure to do so may lower the vehicle performance and make normal functions inoperable, causing an accident while driving.

- When a long period of time has passed even if the mileage is low, the level of oils or coolant may become low. Check it frequently and add it if necessary.
- Used oils, coolant and other solutions and containers should not be discarded with household waste. Discard oils, coolant and other solutions according to a legitimate disposal procedure.

Index

You can conveniently find important functions or terms from the content of this owner's manual in alphabetical order.

+/- (manual) position	4-99
2-row parking ☞ Refer to Double parking (2-row parking) ..	4-188
4D Driving ☞ Refer to No Drugged, Drunk, Distracted and Drowsy (4D) Driving	1-21
4WD CHECK warning lamp	4-36
4WD LOCK ON indicator	4-36
4WD System	4-106

A

ACC position	4-6
ACC status (START/STOP switch)	4-2
Activating glass heater	3-66, 3-69
Adjusting the angle of the backrest	3-9, 3-11
Adjusting the angle of the head light	3-39
Adjusting the headrest	3-7, 3-11
Adjusting the height/length of the steering wheel	3-73
Adjusting the operation speed of the windshield wiper	3-54
Adjusting the power seat	3-8
Adjusting the seat manually	3-10
AEBS ☞ Refer to Autonomous Emergency Braking System (AEBS)	4-148
Air bag	2-20
Collision detection sensor	2-21
Air bag control module	2-21
Air bag warning label	2-20
Air bag warning lamp	2-20, 4-25
air conditioner	
Independent Temperature Control (SYNC Off)	3-63
Temperature Synchronization Control (SYNC On)	3-64
Air conditioner	3-59
Android device	3-75
An infant or a small child must be seated in the rear seat with protective gear	1-22
Antenna (GPS, radio, DMB)	3-78
Anti-Lock Brake System (ABS) ..	4-136
Anti-Lock Brake System (ABS) warning light	4-28, 4-137
Anti-pinch protection function of the power tailgate	3-28
Anti-theft and warning system	2-35
AUTO Approach	3-43
Auto cruise ENABLED	4-113
Auto cruise READY	4-113

Auto Defogger System (ADS)	3-68
Auto door lock function at the time of driving	3-3
Auto door unlock function at the time of collision	3-3
AUTO HOLD	4-146
AUTO HOLD indicator/warning light	4-29
AUTO HOLD ☞ Refer to AUTO HOLD	4-146
Auto light	3-37, 3-45
Autonomous Emergency Braking System (AEBS)	4-148
Autonomous Emergency Braking System (AEBS) OFF indicator	4-32
Autonomous Emergency Braking System (AEBS) warning light	4-31
Average fuel economy (display of the instrument cluster)	4-40
Average speed (display of the instrument cluster)	4-40
AV/Navigation	3-76

B

Be Careful not to Have a Part of Your Body Caught When Using the Power Window	1-23
Blind spot collision assist (BSA) system	4-159
Blind spot detection (BSD) system RCTW System	4-160
Blind Spot Detection (BSD) system	4-158
Bluetooth	3-75
Bluetooth hands-free	3-77
Brake system	4-134
ABS (Anti-Lock Brake System) ..	4-136
Electronic Brake-Force Distribution (EBD)	4-137
Foot brake	4-135
What is the fade phenomenon? ..	4-135
What is the vapor lock phenomenon?	4-135
Brake warning lamp	4-28, 4-137
Breaking in a New Vehicle Correctly	1-29
BSD system ☞ Refer to the Blind Spot Detection (BSD) system	4-158
Buttonless Integrated Control Panel Favorites	3-72
Buttonless Integrated Control Panel Reset	3-72
Buttonless Integrated Control Panel Screen Composition	3-70
Buttonless Integrated Control Panel Screen Off	3-71

Front seat heating / ventilation control screen.....	3-70	Cautions for the Protection of the Environment.....	1-5	Replacing the interior lamps.....	6-33	Auto cruise READY.....	4-113
Heater and A/C control (FATC) screen.....	3-70	Cautions for using smart key / REKES key.....	4-16	Checking Before Driving.....	1-16	Cruise control system.....	4-112
Items to be displayed at all times.....	3-70	Cautions for Using the Vehicle Key.....	1-33	Checking the engine room.....	6-8	Cruise control system indicator..	4-119
Vehicle settings switch.....	3-71	Cautions for Vehicle Ventilation ...	1-28	Checking the status of tire wear ..	6-38	Cup holder.....	3-83
		Cautions for Window Tinting.....	1-32	Checking the tire pressure.....	6-37		
		Centering Lane Keeping Assist (CLKA).....	4-176	Checking the tires and wheels....	6-37	D	
C		Centering lane keeping assist (CLKA) indicator / warning lamp..	4-33	Checking the wheels ☞ Refer to 'Checking the tires and wheels'.....	6-37	Daytime Running Light (DRL).....	3-40
Card holder.....	3-81	Center room lamp.....	3-48	Checking the wipers and replacing the blade.....	6-22	D (driving) position.....	4-98
Care and Cleaning of the Interior.....	1-32	Certification Label.....	1-9	Child restraint for an infant or a small child.....	2-11	Deactivating the cruise control system.....	4-116
Car play.....	3-75	Change of specifications (options) and functions according to a change of design.....	4	Child restraint ☞ Refer to 'Child restraint for an infant or a small child'.....	2-11	Delayed Accelerator Pedal Response ☞ Refer to System Protection Function (Delayed Accelerator Pedal Response).....	1-28
Cases where the air bag does not inflate.....	2-24	Charge warning light.....	4-26	Child safety door lock.....	3-5	Distance to empty (display of the instrument cluster).....	4-39
Cautions for Attaching Accessories.....	1-28	Check for Any Vehicles or Person Passing by When Getting Out.....	1-24	Cleaning and Maintaining Glass..	1-32	Do Not Drive with the Doors or Tailgate Open.....	1-23
Cautions for parking during winter.....	6-43	Checking and replacing fuses and relays.....	6-24	Collision detection sensor.....	2-21	Do Not Drive With the Tailgate or Doors Open.....	1-23
Cautions for parking the vehicle on a downhill road.....	4-145	Checking and replacing the brake discs.....	4-136	Coming home light.....	3-44	Do Not Hold a Part of Your Body Out of the Sunroof or Window.....	1-23
Cautions for parking the vehicle on a uphill road.....	4-145	Checking and replacing the brake pads.....	4-136	Console.....	3-85	Do Not Hold a Part of Your Body Out of the Window or Sunroof.....	1-23
Cautions for Polishing the Vehicle.....	1-31	Checking and replacing the lamps.....	6-26	Crossing an Intersection or Railroad Crossing.....	1-27	Do Not Load Hazardous Materials.....	1-28
Cautions for the Depletion of Battery when Connecting Uninterruptible Power Supply to the Black Box System.....	1-29	Replacing exterior lamps.....	6-29	Crossing a Railroad Crossing or Intersection.....	1-27		
				Cruise Control Ready / Enabled Display Auto cruise ENABLED.....	4-113		

Do not Stop the Engine While Driving	1-25	Driving information after departure (display of the instrument cluster)	4-41
Do not use vehicle components for other purposes	4	Driving Information Display	4-22
Do Not Warm Up the Engine or Check the Vehicle in a Sealed Space	1-27	Driving on a Downhill Road and Hillside Road	1-26
Door	3-2	Driving on a Hillside Road and Downhill Road	1-26
Auto door lock function at the time of driving	3-3	Driving on a Muddy or Sandy Road	1-25
Auto door unlock function at the time of collision	3-3	Driving on an Icy and Snowy Road	1-25
Child safety door lock	3-5	Driving on a River or a Road with a Pool of Water	1-26
Door handle switch	4-14	Driving on a Road with a Pool of Water or a River	1-26
Door map pocket	3-85	Driving on a Sandy or Muddy Road	1-25
Door open warning light	4-37	Driving on a Snowy or Icy Road ..	1-25
Double parking (2-row parking)	4-188	Driving on Mountains and Unpaved Roads	1-25
Driver seat window safety function	3-19	Driving on the Expressway	1-27
Driving a vehicle equipped with an automatic transmission	4-102	Driving on Unpaved and Mountain Roads	1-25
Safety mode of the automatic transmission	4-104	Driving Position	1-19
What is automatic shift point?	4-103	Driving time (display of the instrument cluster)	4-40
What is the creep phenomenon?	4-103	DRL ☞ Refer to 'Daytime Running Light (DRL)'	3-40
What is the engine brake?	4-103		
What is the kick down function?	4-104		

E

EBD ☞ Refer to Electronic Brake-Force Distribution (EBD)	4-137	In the event of an accident	5-29
ECM room mirror	3-57	When a tire is flat	5-8
Electric power steering warning light	4-27	When the engine check indicator turns on	5-7
Electronic Brake-Force Distribution (EBD)	4-137	When the engine is overheated so that the warning light turns on	5-6
Electronic Parking Brake (EPB)	4-143	When the vehicle has stopped due to a failure	5-28
Electronic Parking Brake (EPB) auto unlock	4-144	When you need to have your vehicle towed	5-21
Electronic Parking Brake (EPB) emergency mode	4-144	Emergency Stop Signal (ESS) ...	4-138
Electronic Parking Brake (EPB) warning light	4-29	Engine check indicator	4-29
Electronic stability control system (ESP)	4-139	Engine Check Indicator	1-33, 1-35, 1-36
Electronic stability control system (ESP) OFF indicator	4-30	Engine compartment fuse and relay box	6-24
Electronic stability control system (ESP) ON indicator/ warning light	4-30	Engine hood	3-33
Emergency key	4-17	Engine hood open lever	3-33
Emergency measures in the event of emergency	5-1	Engine Number	1-9
In the event of a fire	5-30	Engine oil pressure warning light	4-25
In the event of a heavy snow	5-31	Engine overheat warning lamp	4-26
		Engine Warm-up	1-24
		EPB ☞ Refer to 'Electronic Parking Brake (EPB)'	4-143
		ESP ☞ Refer to 'Electronic stability control system (ESP)' ...	4-139
		ESS ☞ Refer to Emergency Stop Signal (ESS)	4-138

Extinguisher.....1-28, 5-30

F

Fastening the seat belt by a pregnant woman.....2-9

Foot brake4-135

Front auto washer3-54

Front Camera Module (FCM).....4-165

Front fog lamp ON indicator.....4-33

Front fog light3-37

Front obstacle detection sensor.....4-182

Front obstacle detection warning ON/OFF switch.....4-182

Front/rear obstacle detection system4-182

Front obstacle detection sensor4-182

Rear obstacle detection sensor4-182

Front room lamp (overhead console).....3-47

Front side storage box3-84

Front storage3-83

Front windshield and washer fluid linkage3-54

Fuel gauge (display of the instrument cluster).....4-23

Fuel inlet.....3-34

G

Gear selector lever in automatic transmission

D (driving) position.....4-98

N (neutral) position4-97

P (parking) position.....4-97

If the gear shift lever cannot be moved from the P (parking) position to another position.....4-101

R (reverse) position4-97

Gear shift lever  Refer to automatic gear shift lever....4-92, 4-95

Global warning light.....4-31

Glove box3-84

Glove box lamp3-49

Grip handle/coat hanger.....3-82

H

Hands OFF warning lamp4-35

Hazard warning lamp3-38, 4-34

HBA  Refer to 'High Beam Assist (HBA)'3-41

HDC  Refer to Hill Descent Control (HDC).....4-141

Headlamp desiccant.....6-27

Head light3-37

Headlight  Refer to 'Headlight'3-37

Heater.....3-59

Independent Temperature Control (SYNC Off).....3-63

Temperature Synchronization Control (SYNC On).....3-64

Heater & A/C Controls.....3-62

High beam3-38

High Beam Assist (HBA).....3-37, 3-41

High beam indicator4-34

High mounted stop lamp.....3-36, 6-28

Hill Descent Control (HDC).....4-141

Hill Descent Control (HDC) ON indicator/warning light.....4-32, 4-142

Horn.....3-74

Horn  Refer to 'Horn'3-74

How to Dehumidify Window Glass3-67

How To Lock Doors In Emergency3-4

I

If the gear shift lever cannot be moved from the P (parking) position to another position.....4-101

Illumination ON indicator.....4-33

Immobilizer system.....2-35

Immobilizer system warning light.....4-26

Importance of a periodic check.....4

Indicator panel on instrument cluster4-38

Inflating a tire.....5-15

Information Regarding the Installation of Accident Recording Devices and Provision of Information1-2

Infotainment system.....3-75

Installing a snow tire6-41

Installing the towing hook.....5-22

Instantaneous fuel economy (display of the instrument cluster).....4-40

Instrument cluster.....4-21
Trip computer information.....4-39

Instrument cluster illumination brightness.....4-91

Instrument cluster warning lights and indicators4-25

Intelligent / Adaptive Cruise Control.....4-118

Interior fuse box6-24

Interior temperature sensor.....3-59

In the event of a fire.....5-30

In the event of a heavy snow.....5-31

In the event of an accident5-29



iPod3-76

ISG (Idle Stop & Go) System..... 4-109
 ISG indicator/warning lamp..... 4-35
 ISG OFF indicator 4-36

K

Key cylinder (ignition key)..... 4-6
 Klaxon  Refer to 'Horn'..... 3-74
 Korea Consumer Agency -
 Precautions for Potentially
 Hazardous Seat Belt related
 Goods..... 1-3
 Korea Consumer Agency -
 Precautions for the reduction of
 non-crash incidents 1-4, 1-6

L

Lane Change Assist (LCA)
 system..... 4-159
 Lane Keeping Assistance
 System (LKAS)..... 4-169
 LCA system  Refer to the
 'Lane Change Assist (LCA)
 system' 4-159
 LDWS (Lane Departure
 Warning System)..... 4-165
 LDWS  Refer to LDWS
 (Lane Departure Warning
 System) 4-165



License plate lamp 3-36, 6-28
 Lights and lamps 3-36
 Turning off all lights 3-37
 Light switch..... 3-37
 Living home light 3-44
 LKAS (LDWS) indicator /
 warning lamp 4-32
 Load limiter..... 2-9
 Long-term parking mode 1-29
 Low fuel level warning light..... 4-31
 Luggage compartment 3-89
 Luggage compartment..... 3-90
 Luggage room lamp 3-48
 Luggage upper cover 3-89

M

Main menu on the instrument
 cluster..... 4-38
 Managing the A/C (winter) 6-42
 Managing the engine coolant
 (winter)..... 6-41
 Managing the engine oil (winter).. 6-41
 Managing washer fluid (winter).... 6-41
 Manual tailgate..... 3-25
 Master symbol (Supervision
 type)..... 4-37

Media Display..... 4-41
 Message message on the
 display of the instrument cluster .. 4-48
 Mileage (display of the
 instrument cluster)..... 4-40
 Mirror 3-56
 ECM room mirror..... 3-57
 Outside rearview mirror control
 button..... 3-56
 Mirror and lamp 3-81
 Mood lamp* 3-49

N

Navigation  Refer to 'AV/
 Navigation'..... 3-76
 N (neutral) position..... 4-97
 No Drugged, Drunk, Distracted
 and Drowsy (4D) Driving..... 1-21
 Non-crash incident  Refer
 to Korea Consumer Agency -
 Precautions for the reduction of
 non-crash incidents 1-4, 1-6
 No Sleeping in a Sealed
 Vehicle..... 1-22
 No Sudden Maneuvering of the
 Steering Wheel..... 1-26, 1-27
 No Sudden Starting,
 Acceleration, or Braking..... 1-25

O

OFF position (LOCK) 4-6
 OFF status (START/STOP
 switch) 4-2
 ON position..... 4-6
 ON status (START/STOP
 switch) 4-2
 Opening the tailgate in the
 event of emergency..... 3-31
 Operating smart audio and AV/
 navigation using the steering
 wheel 3-77
 Outside rearview mirror auto
 folding/unfolding function..... 3-56
 Outside rearview mirror control
 button..... 3-56
 Over speed warning light 4-37
 OVM  Refer to 'OVM tools' 5-2
 OVM tools..... 5-2

P

Panic mode 4-12
 Parking
 Cautions for parking during
 winter 6-43
 Safe Parking and Stopping..... 1-24
 When parking the vehicle on a
 downhill road..... 4-145

When parking the vehicle on a uphill road.....	4-145	Precautions for the Modification of the Vehicle and Structural Alteration	1-14	Rear obstacle detection sensor.....	4-182	Resetting the mileage (display of the instrument cluster)	4-40
Parking assist system	4-182	Prescribed tire inflation pressure.....	6-37	Rear seat.....	3-11	Resetting the opening height of the power tailgate.....	3-28
Front/rear obstacle detection system.....	4-182	Pretensioner	2-8	Heating function (heater).....	3-16	Resetting the power tailgate	3-28
Rear camera system	4-186	Purpose and application conditions of the instruction manual.....	3	Rear seat backrest folding.....	3-13	Resetting the sunroof	3-24
Parking brake ON indicator (red).....	4-27			Seatback reclining adjustment.....	3-12		
Passing light ☞ Refer to 'Turning on the high beam and low beam at the same time (passing light)'.....	3-38			Rear seat door roller blind	3-82	Restarting the engine when it cannot be started	4-3, 4-7
Position of the gear shift lever (display of the instrument cluster).....	4-24			Rear seat window lock function ...	3-20	Restart when engine does not start.....	4-96
Potentially hazardous seat belt related goods ☞ Refer to the Korea Consumer Agency - Precautions for Potentially Hazardous Seat Belt related Goods	1-3	R		Rear storage box.....	3-84	Resuming the cruise control system (RESUME)	4-117
Power socket.....	3-80	Rain sensing wiper.....	3-55	Rear window wiper washer fluid linkage function	3-55	Roof rack.....	3-91
Power tailgate.....	3-26	Rain sensor	3-55	Repairing a flat tire.....	5-10	Rotating the tire positions	6-38
Power window ☞ Refer to 'Window (power window)'.....	3-18	RCTA system ☞ Refer to Rear Cross Traffic Alert (RCTA) system	4-160	Repairing a flat tire ☞ Refer to 'Repairing a flat tire'	5-10	R (reverse) position.....	4-97
P (parking) position	4-97	READY status (START/STOP switch)	4-2	Replacing A/C refrigerant/oil	3-60		
Precautions for infants, children, old people, or pregnant women.....	1-22	REAR status (START/STOP switch)	4-2	Replacing exterior lamps.....	6-29	S	
		Rear and side warning system	4-156	Replacing the A/C filter	6-35	Safe Parking and Stopping	1-24
		Blind Spot Detection (BSD) system.....	4-158	Replacing the interior lamps	6-33	Safety and Cautions for Driving... 1-21	
		Lane Change Assist (LCA) system.....	4-159	Replacing the smart key battery.....	4-19	Safety exit warning (SEW) system.....	4-164
		Rear camera system.....	4-186	Resetting the average fuel economy (display of the instrument cluster).....	4-40	SD card (navigation)	3-76
		Rear cross traffic assist (RCTA) system	4-162	Resetting the average speed (display of the instrument cluster).....	4-40	Seat	
		Rear fog lamp ON indicator	4-33	Resetting the driving time (display of the instrument cluster).....	4-40	Seat & adjustment switch / button / lever	3-6
		Rear lamp.....	3-36, 6-28			Ventilation and heating	
						Smart front seat heating control....	3-15
						Seatback reclining adjustment	3-12

Seat backrest pocket.....	3-86	Panic mode.....	4-12	Steering wheel heater indicator Heating.....	4-30
Seat belt.....	2-2	Smart key warning light.....	4-26	Stopping the engine.....	4-4, 4-8
Fastening the seat belt by a pregnant woman.....	2-9	Smart tailgate.....	3-29	Stopping the engine while driving (in the event of emergency).....	4-4
Load limiter.....	2-9	Snow tire.....	6-38	Stopping the engine while driving (in the event of emergency).....	4-4
Pretensioner.....	2-8	Special Cautions When Checking the Coolant.....	1-28	Stopping the smart tailgate function.....	3-30
Warnings.....	2-9	Speed limit.....	4-131	Storage unit.....	3-83
Seat Belt		Starting the engine.....	4-3, 4-7	Console.....	3-85
Wearing the Seat Belt Correctly...	1-20	Restarting the engine when it cannot be started.....	4-3, 4-7	Cup holder.....	3-83
Seat belt warning lamp.....	4-25	Starting the engine using the jump cable.....	5-4	Door map pocket.....	3-85
Seat Ventilation & Heating.....	3-14	Starting the engine and driving the vehicle (winter).....	6-41	Front storage.....	3-83
Service kit for tire repair.....	5-9	Starting the engine using the jump cable.....	5-4	Glove box.....	3-84
Setting the cruise control system driving speed.....	4-113	Starting the engine with a depleted smart key or interference (in the event of emergency).....	4-19	Seat backrest pocket.....	3-86
Setting the sensitivity of the forward collision warning for Autonomous Emergency Braking System (AEBS).....	4-149	START position.....	4-6	Sunroof.....	3-21
SHB indicator.....	4-33	START/STOP switch.....	4-2	Sunroof open warning.....	3-23
Shift Lock.....	4-96	ACC status.....	4-2	Sunroof safety function.....	3-23
Side repeater.....	3-36, 6-28	OFF status.....	4-2	Sun visor.....	3-81
Slots for multimedia.....	3-76	ON status.....	4-2	Sun visor/mirror lamp.....	3-48, 3-81
Smart audio*.....	3-75	READY status.....	4-2	Switch Between Buttonless Integrated Control Panel Screens.....	3-69
Smart door auto lock (auto close).....	4-13	Steering wheel.....	3-73	System Protection Function (Delayed Accelerator Pedal Response).....	1-28
Smart front seat heating control.....	3-15	Horn.....	3-74	System safety mode.....	4-4, 4-8
Smart key.....	4-10	Steering wheel heater.....	3-73		

T

Table of Vehicle Specifications	1-11, 1-12, 1-13
Tailgate.....	3-25
Anti-pinch protection function of the power tailgate.....	3-28
Manual tailgate.....	3-25
Opening the tailgate in the event of emergency.....	3-31
Power tailgate.....	3-26
Resetting the opening height of the power tailgate.....	3-28
Resetting the power tailgate.....	3-28
Smart tailgate.....	3-29
Stopping the smart tailgate function.....	3-30
Tail light.....	3-37
Tips when an accident or a malfunction occurs on the expressway.....	5-29
Tire chain.....	6-39
Tire pressure monitoring system (TPMS).....	2-29
Display of the TPMS status on the instrument cluster.....	2-31
To Adjust Instrument Cluster Illumination Brightness.....	4-91
Total mileage (display of the instrument cluster).....	4-23

TPMS  Refer to the tire pressure monitoring system (TPMS)	2-29
TPMS (Tire Pressure Monitoring System) Display of the TPMS status on the instrument cluster	4-42
Trip computer information	4-39
Turning on the high beam and low beam at the same time (passing light)	3-38
Turn signal.....	3-37, 4-34



U

USB charging port.....	3-79
Use of Engine Brake.....	1-27
Use of service centers and maintenance partners.....	4
Use of Service Centers and Maintenance Partners	1-29
User settings	4-43
User settings on the instrument cluster	4-43
Using a towing rope	5-23
Using a tow truck	5-21
Using Genuine Parts.....	1-29
Using the engine brake...4-101, 4-103	

V

Vehicle Identification.....	1-9
Vehicle Identification Number (VIN)	1-9
Vehicle Management.....	1-29
Vehicle management during winter.....	6-41
Cautions for parking	6-43
Installing a snow tire.....	6-41
Managing the A/C	6-42
Managing the engine coolant	6-41
Managing the engine oil	6-41
Managing washer fluid.....	6-41
Starting the engine and driving the vehicle.....	6-41
Vehicle Specifications.....	1-10
Vehicle Washing.....	1-30
Cleaning and Maintaining Glass... 1-32	
Washing the Bumper	1-31
Washing Wheels.....	1-31
Voice recognition function	3-78

W

Warm-up  Refer to 'Engine Warm-up'	1-24
Warm-up'	1-24
Warning horn  Refer to 'Horn'	3-74
Warning lights and indicators.....	4-25

Warnings for self-maintenance	6-44
Warning triangle	5-2
Washer fluid	3-54
Washing the Bumper.....	1-31
Washing Wheels	1-31
Wearing the Seat Belt Correctly	1-20
What is safety unlock?.....	4-11
What is the creep phenomenon?.....	4-103
What is the engine brake?.....	4-103
What is the fade phenomenon? 1-27, 4-135	
What is the kick down function? 4-104	
What is the standing wave phenomenon?.....	1-18
What is the vapor lock phenomenon?.....	1-27, 4-135
What is wind buffeting?.....	3-20, 3-22
Wheel alignment status and the balance between tires and wheels	6-37
When a tire is flat.....	5-8
When a tire is flat  Refer to 'When a tire is flat'	5-8
When a tow truck is unavailable (in case of emergency)	5-22
Installing the towing hook	5-22

Using a towing rope.....	5-23
When low tire pressure is detected.....	2-33
When the engine cannot be started due to depletion of the battery.....	5-4
When the engine check indicator turns on.....	5-7
When the engine is overheated so that the warning light turns on ..	5-6
When the vehicle has stopped due to a failure	5-28
When you have rotated the tires..	3-33
Window (power window)	3-18
Driver seat window safety function	3-19
Rear seat window lock function....	3-20
Windshield fog detection sensor.....	3-59
WINTER / SPORT indicator lamp.....	4-35
Wiper	3-54
Adjusting the operation speed of the windshield wiper	3-54
Front windshield and washer fluid linkage.....	3-54
Rain sensing wiper	3-55
Rear window wiper washer fluid linkage function.....	3-55
Wireless Phone Charger System*	3-86

No.	PART NO.	CODE NO.	PRINTING DATE	MODEL	REMARKS
1	J101OM2305E	TR1-3OM5E-3E-300A	May. 01, 2023	J101	EU

TORRES (LHD) OWNER'S MANUAL

ISSUED BY
EXPORT SERVICE TEAM
KG Mobility Corporation

455-12, Dongsak-ro, Pyeongtaek-si,
Gyeonggi-do, 17749, Korea

TELEPHONE : 82-80-500-5582
FACSIMILE : 82-31-610-3762

NOTE: *All rights reserved. Printed in KG Mobility Corporation.
No part of this book may be used or reproduced without the
written permission of Export Service Team.*

<https://www.automotive-manuals.net/>