目录

1.1 Electrical protection	1
Summary	1
Equipment.....	1
Polarity.....	1
Disconnect the battery	1
Battery charging	1
Connector and wiring harness.....	1
1.2 Wiring harness color information	2
1.3 Wiring harness code explanation	3
1.4 Configuration code	4
1.5 How to use the circuit diagram	6
2.1 Battery positive fuse box	9
2.2 Engine Room fuse box	10
2.2.1 Fuse information sheet.....	10
2.2.2 Relay information sheet.....	11
2.3 Instrument fuse box	13
2.3.1 Fuse information sheet.....	13
2.3.2 Relay information sheet.....	14
4.1 Engine compartment wiring harness	15
4.1.1 Engine compartment wiring harness EB plug-in description	17
4.2 Chassis harness.....	45
4.2.1 Chassis harness CH.....	46
4.3 Roof harness.....	51
4.3.1 Roof harness connector description.....	52
4.4 Door harness.....	57
4.4.1 Door harness DD connector description.....	59
4.5 Battery harness	63
4.5.1 Battery harness connector description.....	64
4.6 Instrument Harness.....	68
4.6.1 Instrument Harness 1 - Left rudder	68
4.6.2 Instrument Harness 2 - Left rudder	69
4.6.3 Instrument Harness 1 - Right rudder	70
4.6.4 Instrument Harness 4 - Right rudder	71
4.6.5 Instrument Harness IP	72
5.1 Power Distribution	97
5.1.1 Power distribution 1 left rudder.....	97
5.1.2 Power distribution 2 left rudder	98
5.1.3 Power distribution 1 right rudder	99
5.1.4 Power distribution 2 right rudder.....	100
5.2 Power mode System.....	101
5.3 CDU System	102
5.4 ABS System	103
5.4.1 ABS System - left rudder.....	103
5.4.2 ABS System -right rudder	104

5.5 Electric Power Steering System	105
5.5.1 Electric Power Steering System -left rudder.....	105
5.5.2 Electric Power Steering System - right rudder.....	106
5.6 AIRBAG system	107
5.6.1 AIRBAG system 1	107
5.6.2 AIRBAG system 2	108
5.7 Air Conditioning System	109
5.7.1 Air Conditioning System 1-left rudder.....	109
5.7.2 Air Conditioning System 2 -left rudder.....	110
5.7.3 Air Conditioning System 3 -left rudder.....	111
5.7.4 Air Conditioning System 4 -left rudder.....	112
5.7.5 Air Conditioning System 5-left rudder.....	113
5.7.6 Air Conditioning System 1 - right rudder.....	114
5.7.7 Air Conditioning System 2 - right rudder.....	115
5.7.8 Air Conditioning System 3 - right rudder.....	116
5.8 Sound entertainment system.....	117
5.8.1 Sound entertainment system (MP3)1-left rudder	117
5.8.2 Sound entertainment system (MP3)2-left rudder	118
5.8.3 Sound entertainment system (MP5)1-left rudder	119
5.8.4 Sound entertainment system (MP5)2-left rudder	120
5.8.5 Sound entertainment system (MP5)3-left rudder	121
5.8.6 Sound entertainment system (MP5 DR)1-left rudder.....	122
5.8.7 Sound entertainment system (MP5 DR)2-left rudder.....	123
5.8.8 Sound entertainment system (MP5 DR)3-left rudder.....	124
5.8.9 Sound entertainment system (MP3)1-right rudder	125
5.8.10 Sound entertainment system (MP3)2-right rudder.....	126
5.8.11 Sound entertainment system (MP5)1-right rudder.....	127
5.8.12 Sound entertainment system (MP5)2-right rudder.....	128
5.8.13 Sound entertainment system (MP5)3-right rudder.....	129
5.8.14 Sound entertainment system (MP5 DR)1-right rudder.....	130
5.8.15 Sound entertainment system (MP5 DR)2-right rudder.....	131
5.8.16 Sound entertainment system (MP5 DR)3-right rudder.....	132
5.9 Body control system.....	133
5.9.1 Body control system 1-Left Rudder.....	133
5.9.2 Body control system 2-Left Rudder.....	134
5.9.3 Body control system 3-Left Rudder.....	135
5.9.4 Body control system 4-Left Rudder.....	136
5.9.5 Body control system 5-Left Rudder.....	137
5.9.6 Body control system 6-Left Rudder.....	138
5.9.7 Body control system 7-Left Rudder.....	139
5.9.8 Body control system 8-Left Rudder.....	140
5.9.9 Body control system 1-Right Rudder.....	141
5.9.10 Body control system 2-Right Rudder.....	142
5.9.11 Body control system 3-Right Rudder.....	143
5.9.12 Body control system 4-Right Rudder.....	144

5.9.13	Body control system 5-Right Rudder	145
5.9.14	Body control system 6-Right Rudder	146
5.9.15	Body control system 7-Right Rudder	147
5.9.16	Body control system 8-Right Rudder	148
5.10	Outside rearview mirror	149
5.10.1	Outside rearview mirror 1 -Left Rudder	149
5.10.2	Outside rearview mirror 2 -Left Rudder	150
5.10.3	Outside rearview mirror 1 - Right Rudder	151
5.10.4	Outside rearview mirror 2 - Right Rudder	152
5.11	IPK System.....	153
5.11.1	IPK System - Left Rudder	153
5.11.2	IPK System - Right Rudder	154
5.12	AVAS System.....	155
5.12.1	AVAS System - Left Rudder	155
5.12.2	AVAS System - Right Rudder.....	156
5.13	PEB System.....	157
5.13.1	PEB System - Left Rudder	157
5.13.2	PEB System - Right Rudder	158
5.14	Cigar Lighter Sytem	159
5.14.1	Cigar Lighter Sytem - Left Rudder	159
5.14.2	Cigar Lighter Sytem - Right Rudder	160
5.15	Lane change assist system.....	161
5.15.1	Lane change assist system - Left Rudder	161
5.15.2	Lane change assist system - Right Rudder	162
5.16	T-BOX system.....	163
5.16.1	T-BOX system - Left Rudder.....	163
5.16.2	T-BOX system - Right Rudder.....	164
5.17	Interior lighting system.....	165
5.17.1	Interior lighting system 1 -Left Rudder	165
5.17.2	Interior lighting system 2 -Left Rudder	166
5.17.3	Interior lighting system 1 - Right Rudder.....	167
5.17.4	Interior lighting system 2 - Right Rudder.....	168
5.18	Exterior lighting system.....	169
5.18.1	Exterior lighting system 1 - Left Rudder	169
5.18.2	Exterior lighting system 2 - Left Rudder	170
5.18.3	Exterior lighting system 3 - Left Rudder	171
5.18.4	Exterior lighting system 4(1405) - Left Rudder.....	172
5.18.5	Exterior lighting system 4(1406、1409) - Left Rudder.....	173
5.18.6	Exterior lighting system 4(CAB) - Left Rudder	174
5.18.7	Exterior lighting system 1 - Right Rudder.....	175
5.18.8	Exterior lighting system 2 - Right Rudder.....	176
5.18.9	Exterior lighting system 3 - Right Rudder.....	177
5.18.10	Exterior lighting system 4(1405) - Right Rudder.....	178
5.18.11	Exterior lighting system 4(1406、1409) - Right Rudder	179
5.18.12	Exterior lighting system 4(CAB) - Right Rudder.....	180

5.19 Vehicle safety system.....	181
5.19.1 Vehicle safety system 1 - Left Rudder.....	181
5.19.2 Vehicle safety system 2 - Left Rudder.....	182
5.19.3 Vehicle safety system 1 - Right Rudder.....	183
5.19.4 Vehicle safety system 2 - Right Rudder.....	184
5.20 ADAS system.....	185
5.20.1 ADAS system - Left Rudder.....	185
5.20.2 ADAS system - Right Rudder.....	186
5.21 Vehicle Control System	187
5.21.1 Vehicle Control System 1 - Left Rudder.....	187
5.21.2 Vehicle Control System 2 - Left Rudder.....	188
5.21.3 Vehicle Control System 3 - Left Rudder.....	189
5.21.4 Vehicle Control System 1 - Right Rudder.....	190
5.21.5 Vehicle Control System 2 - Right Rudder.....	191
5.21.6 Vehicle Control System 3 - Right Rudder.....	192
5.22 On-board diagnostic system.....	193
5.22.1 On-board diagnostic system - Left Rudder.....	193
5.22.2 On-board diagnostic system - Right Rudder.....	194
5.23 Electric Windows system.....	195
5.23.1 Electric Windows system - Left Rudder.....	195
5.23.2 Electric Windows system - Right Rudder.....	196
5.24 Power Pedal system.....	197
5.24.1 Power Pedal system - Left Rudder.....	197
5.24.2 Power Pedal system - Right Rudder.....	198
5.25 Horn and switch system.....	199
5.25.1 Horn and switch - Left Rudder.....	199
5.25.2 Horn and switch - Right Rudder.....	200
5.26 Passive Entry & Passive Start System.....	201
5.26.1 Passive Entry & Passive Start System 1 - Left Rudder.....	201
5.26.2 Passive Entry & Passive Start System 2 - Left Rudder.....	202
5.26.3 Passive Entry & Passive Start System 1 - Right Rudder.....	203
5.26.4 Passive Entry & Passive Start System 2 - Right Rudder.....	204
5.27 Fire extinguisher system.....	205
5.27.1 Fire extinguisher system.....	205
5.28 Cooling Fan System.....	206
5.28.1 Cooling Fan System 1 - Left Rudder.....	206
5.28.2 Cooling Fan System 2 - Left Rudder.....	207
5.28.3 Cooling Fan System - Right Rudder.....	208
5.29 Parking Distance Control System.....	209
5.29.1 Parking Distance Control System 1 - Left Rudder.....	209
5.29.2 Parking Distance Control System 2 - Left Rudder.....	210
5.29.3 Parking Distance Control System 1 - Right Rudder.....	211
5.29.4 Parking Distance Control System 2 - Right Rudder.....	212
5.30 Electronic shift system	213
5.30.1 Electronic shift system - Left Rudder.....	213

5.30.2 Electronic shift system-Right Rudder.....	214
5.31 Wiper and scrubber.....	215
5.31.1 Wiper and scrubber - Left Rudder	215
5.31.2 Wiper and scrubber - Right Rudder.....	216
5.32 Driving Video Recorder System.....	217
5.32.1 Driving Video Recorder System - Left Rudder.....	217
5.32.2 Driving Video Recorder System - Right Rudder.....	218
5.33 Battery Management System.....	219
5.33.1 Battery Management System (CN)1 - Left Rudder	219
5.33.2 Battery Management System (CN)2 - Left Rudder	220
5.33.3 Battery Management System (FRA)1 - Left Rudder.....	221
5.33.4 Battery Management System (FRA)2 - Left Rudder.....	222
5.33.5 Battery Management System (FRA)1 - Right Rudder.....	223
5.33.6 Battery Management System (FRA)2 - Right Rudder.....	224
5.34 Gateway system.....	225
5.34.1 Gateway system 1 - Left Rudder	225
5.34.2 Gateway system 2 - Left Rudder	226
5.34.3 Gateway system 3 - Left Rudder	227
5.34.4 Gateway system 4 - Left Rudder	228
5.34.5 Gateway system 5 - Left Rudder	229
5.34.6 Gateway system 6 - Left Rudder	230
5.34.7 Gateway system 1 - Right Rudder.....	231
5.34.8 Gateway system 2 - Right Rudder.....	232
5.34.9 Gateway system 3 - Right Rudder.....	233
5.34.10 Gateway system 4 - Right Rudder.....	234
5.34.11 Gateway system 5 - Right Rudder.....	235
5.34.12 Gateway system 6 - Right Rudder.....	236
5.35 Grounding.....	237
5.35.1 Grounding 1 - Left Rudder	237
5.35.2 Grounding 1 - Left Rudder	238
5.35.3 Grounding 1 - Left Rudder	239
5.35.4 Grounding 4 - Left Rudder	240
5.35.5 Grounding 5 - Left Rudder	241
5.35.6 Grounding 6 - Left Rudder	242
5.35.7 Grounding 7 - Left Rudder	243
5.35.8 Grounding 8 - Left Rudder	244
5.35.9 Grounding 9 - Left Rudder	245
5.35.10 Grounding 1 - Right Rudder.....	246
5.35.11 Grounding 2 - Right Rudder.....	247
5.35.12 Grounding 3 - Right Rudder.....	248
5.35.13 Grounding 4 - Right Rudder.....	249
5.35.14 Grounding 5 - Right Rudder.....	250
5.35.15 Grounding 6 - Right Rudder.....	251
5.35.16 Grounding 7 - Right Rudder.....	252
5.35.17 Grounding 8 - Right Rudder.....	253

1.1 Electrical protection

Summary

The instructions below aim to ensure the safety of the operator and prevent the damage to the electrical and electronic components.

Equipment

Before the vehicle test procedures, ensure that the relevant test equipment works normally, the wiring harness and connector are well connected.

Warning: ensure that the high-voltage terminals, adapters and diagnostic equipment for testing are fully insulated or isolated to prevent the personal accidents and minimize the possibility of electric shock before any operation on the ignition system.

Polarity

It is forbidden to connect the two poles of the battery reversely. When connecting to the test equipment, the two poles must be connected correctly.

Disconnect the battery

Before disconnecting the battery, turn off all the electrical equipment. When the battery is disconnected, some data may be lost, such as clock time.

Warning: In order to prevent the damage to the electrical equipment, it is necessary to disconnect the battery when repairing the electrical system of the vehicle. When disconnecting the battery, the grounding terminal must be disconnected first; when connecting, it must be connected finally.

Ensure that the battery wiring harness connection is correct at any time, and properly arranged, away from any potential hazards.

Battery charging

When the battery is charged outside the vehicle, good ventilation must be ensured on the top of the battery. When the battery is charged and discharged for about 15 minutes, hydrogen will be released from the battery. This gas is flammable.

Always ensure the good ventilation in the battery charging area at any time, and prevent the open flames and sparks.

Connector and wiring harness

Make sure that the electronic parts and connectors are dry and free of oil before disconnecting and connecting the test equipment. It is forbidden to remove and install the connector with tools and by pulling the wiring harness.

Keep the greasy hands from touching the electronic connection area when replacing the parts. Make sure that the connector is dry free of oil and that the connector clamps are fully engaged.

1.2 Wiring harness color information

Wiring harness color	Wiring harness color (English)	Wiring harness color (Chinese)
BK	Black	Black
BN	Brown	Brown
BU	Blue	Blue
GY	Gray	Gray
GN	Green	Green
NAT	Nature	Nature
OG	Orange	Orange
PK	Pink	Pink
PU	Purple	Purple
RD	Red	Red
TN	Tan	Tan
WH	White	White
YE	Yellow	Yellow
D-BU	Dark Blue	Dark Blue
L-BU	Little Blue	Little Blue
D-GN	Dark Green	Dark Green
L-GN	Little Green	Little Green
YE/BK	Yellow/Black	Yellow/Black
BARE	Bare	Bare

Note: Combination of two color codes is the mixed color code, and the first letter indicates the main color and the last letter indicates the auxiliary color. (For example: YE/WH indicates the mixed color wire with yellow as the main color and white as the auxiliary color.)

1.3 Wiring harness code explanation

Wiring harness code	Wiring harness English in full spelling	Wiring harness name
BD	Chassis harness	Chassis harness
EB	Forward harness	Forward harness
IP	Instrument harness	Instrument harness
PD	Passenger Door harness	Passenger Door harness
DD	Diriver Door harness	Diriver Door harness
TL	Tailgate door	Tailgate door

1.4 Configuration code

English code	Configuration Name
ALL	Standard configuration
C01B	NGC 1.3T(110 kw/220Nm)
C01H	SGE 1.5T Plus(119 kw/250Nm)
C01J	SGE 1.5T(119 kw/250Nm)
E00G	SAIC Gear 6MT
E00S	SAIC Gear DCT
440A	Electric rear door
440C	Manual rear lift door (non-blind window)
C08A	National 6a
C08H	National 5
E10F	Front-engine Front-drive
H10E	ESP+EBA+HHC
H30E	Electronic parking brake
H30H	Hand parking brake
J17P	Tire pressure monitoring system
J17X	No Tire pressure monitoring system
K20B	Electric exterior rearview mirror
K20E	Electric exterior rearview mirror with heating
K20M	Electric folding exterior rearview mirror with heating
M01C	Rollover, vanity mirror, wallet, lighting
M01D	Rollover, wallet, without vanity mirror
M02C	Rollover, vanity mirror, wallet
M02J	Rollover, wallet, No vanity mirror
M02K	Rollover, vanity mirror, wallet, lighting
Q05A	Driver and passenger's airbag
Q05X	No Driver and passenger's airbag
Q08C	Front and rear through air curtain
Q08X	No Air curtain
N00L	Driver seat electric 6-way
N02N	Passenger seat electric 4-way
R02F	Combination meter configuration 2 (low configuration)
S25V	Rear camera
S25W	BVS-SD (360° standard around view monitor)
S25X	Without rear camera
S30P	Keyless entry and start system
S30X	No Keyless entry and start system
S32M	Anti-theft system with engine electronic chip
S35S	Front electric sunroof

English code	Configuration Name
S35U	Panorama sunroof
S35X	No Sunroof
S46R	Rear wiper
S46X	No rear wiper
S41A	Reversing radar
S41S	Front parking and reversing sensor
S41X	No Reversing radar
S51C	Driver's power window One-key regulating (with anti-pinch)
S51D	Driver's power window One-key declining
S52A	Passenger's power window One-key regulating (with anti-pinch)
S52C	Passenger's power window regulating and declining
S53A	Rear power window One-key regulating (with anti-pinch)
S53C	Rear power window regulating and declining
S68C	IP+DP Red atmosphere light
S68D	IP+DP 64-color atmosphere light
S68E	IP+DP+CNSL 64-color atmosphere light
S68F	IP+DP+CNSL+ROOF 64-color atmosphere light
S68X	No ambient light
T07B	Rear air conditioner with single cold air conditioner
T07X	No rear air conditioner
T11A	Manual front AC

1.5 How to use the circuit diagram

Power supply mode description

B+	Battery positive	positive battery
ACC	Ignition switch unlocks	Ignition switch unlocks
IG1	Ignition switch 1	Ignition switch1
IG2	Ignition switch 2	Ignition switch1
ST	Ignition switch starts	Ignition switch starts

Wire properties

IP 5391AD PU FLRB 0.35 AT

The description of the wire properties is located above the wire in the circuit diagram.

“IP” indicates the instrument panel wiring harness;

“5391AD” indicates the wire code;

“PU” indicates the wire color, refer to “wiring harness color information” for details.

“0.35” indicates the section area of the wire, in square millimeter;

“AT” indicates 6AT Bunge

Connector

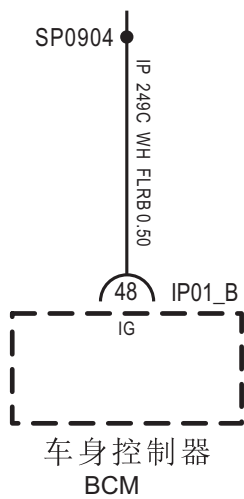

For example: IP01_B indicates connector IP01_B, pin No. 48.

---Indicating the female connector

---Indicating the male connector

Grounding point



Grounding points are generally indicated by double-loop symbols, marked with grounding points, as shown in Figure G_EBR3.

Twisted pair

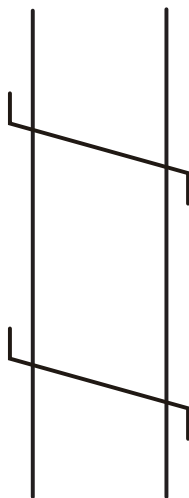

The twisted pair is shown as in the circuit diagram.

Shielding wire

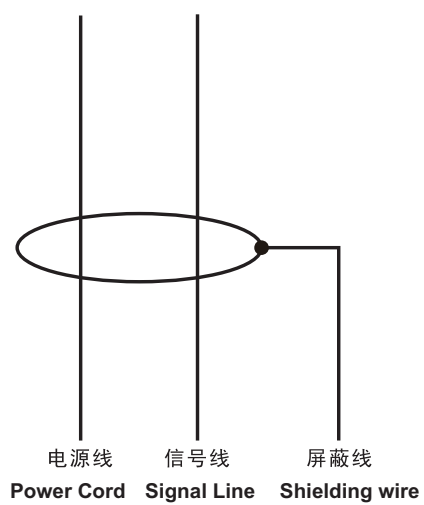

The shielding wire is as shown in the circuit diagram.

2.1 Battery positive fuse box

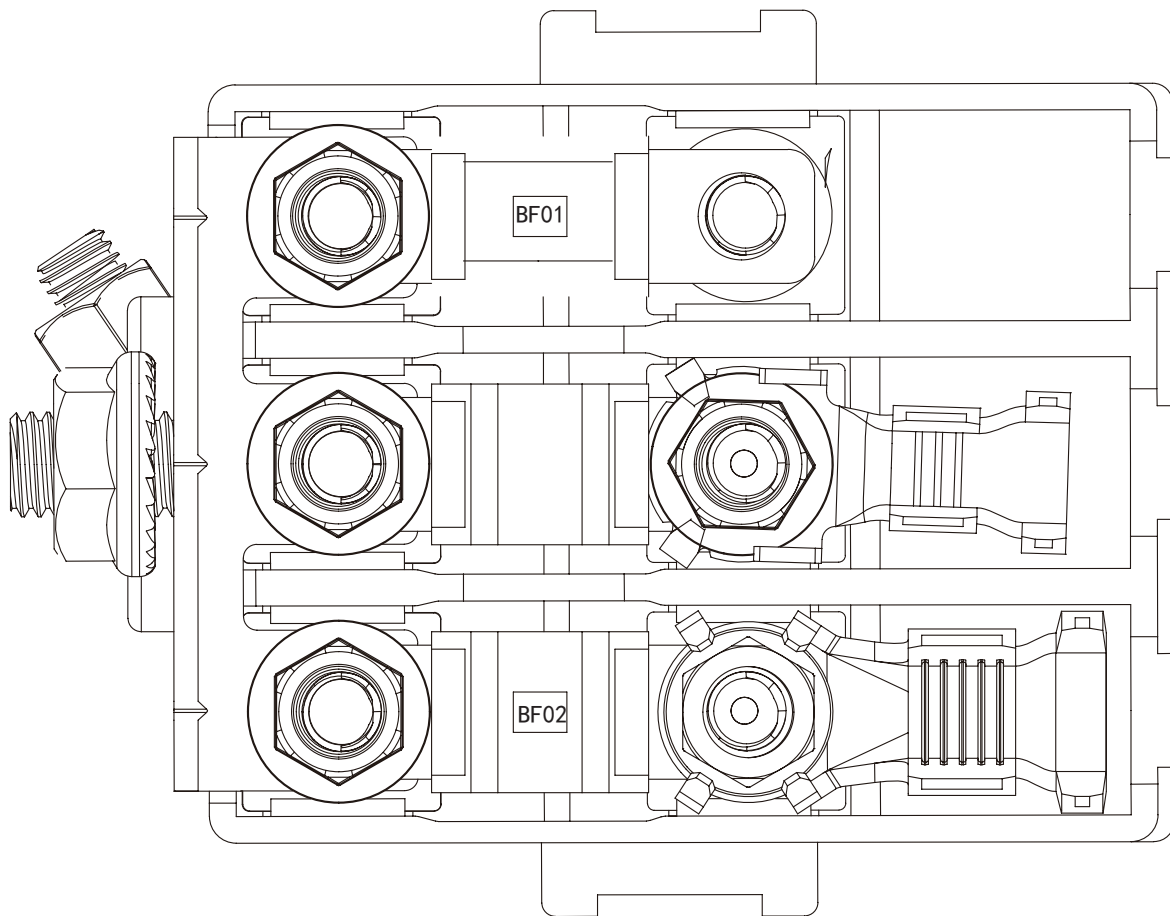

Fuse box	Specifications	Functions
BF01	250A	CDU
BF02	200A	UEC

2.2 Engine Room fuse box

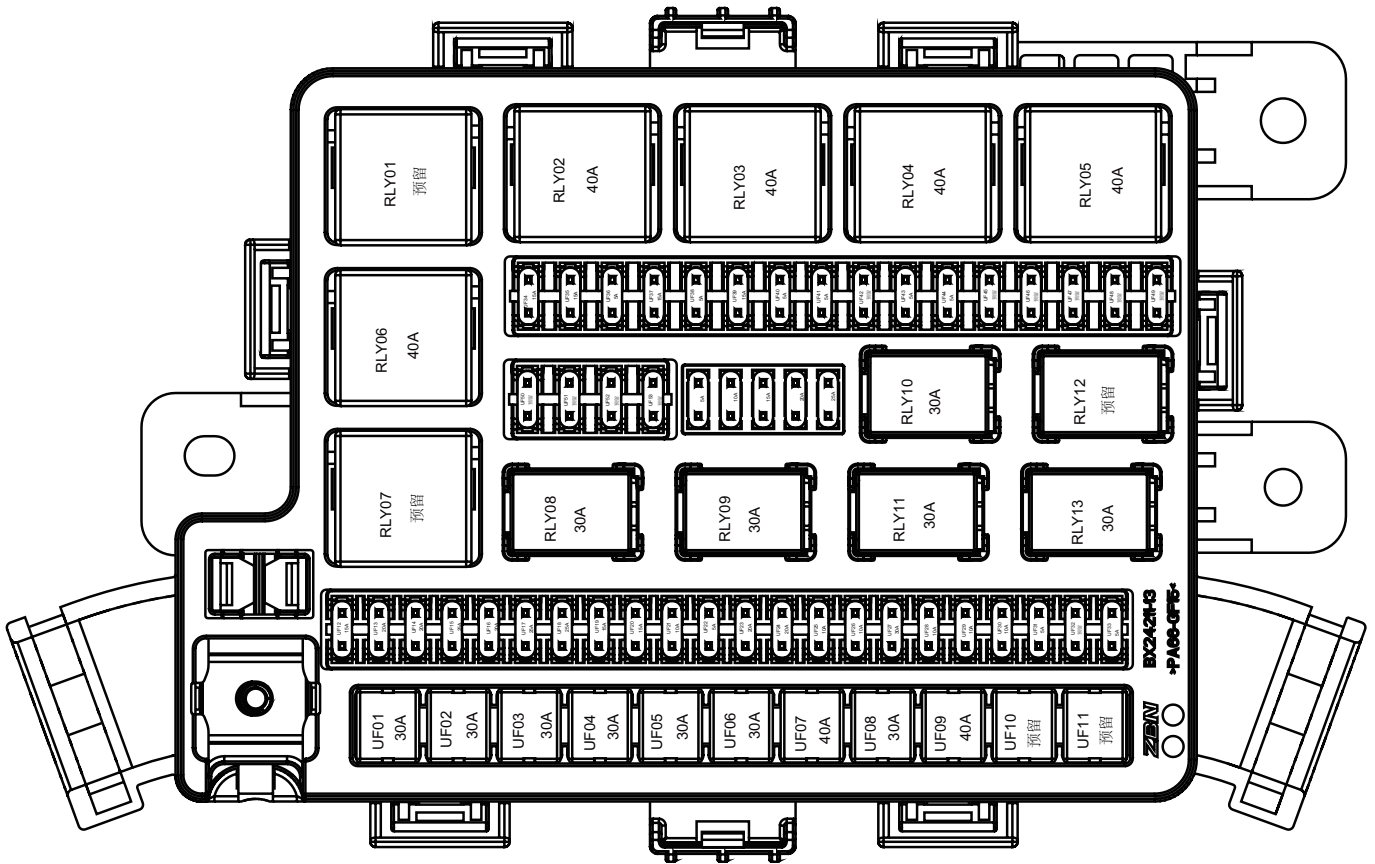

51

2.2.1 Fuse information sheet

Fuse box	Specifications	Functions
UF01	30A	IEC1
UF02	30A	IEC2
UF03	30A	Main relay power supply
UF04	30A	ACC
UF05	30A	Air Blower
UF06	30A	IGN
UF07	40A	ESC
UF08	30A	Electronic vacuum pump
UF09	40A	Cooling Fan
UF10	SPARE	SPARE
UF11	SPARE	SPARE
UF12	15A	Washing Motor
UF13	20A	Electric Horn
UF14	20A	SPOS
UF15	25A	Door Lock Motor
UF16	20A	External lamp power supply1

Fuse box	Specifications	Functions
UF17	25A	External lamp power supply2
UF18	25A	Wiper motor
UF19	15A	Tailgate motor
UF20	15A	Turn Signal
UF21	10A	Internal Lamp Power Supply
UF22	5A	Rear View Camera
UF23	20A	Main glass elevator motor
UF24	20A	Copilot Glass Elevator Motor
UF25	10A	MCU
UF26	10A	VCU
UF27	30A	ESC Valve
UF28	10A	BMS
UF29	10A	EVCC\Charging port
UF30	10A	CDU
UF31	5A	KL30
UF32	SPARE	SPARE
UF33	5A	Day Light
UF34	15A	VCU
UF35	15A	Electronic water pump
UF36	5A	Relay Coil
UF37	15A	VCU2
UF38	5A	Charging indicator
UF39	15A	IEC15
UF40	5A	MCU\CDU\VCU\BMS
UF41	5A	ESC
UF42	10A	Rear-view mirror hot
UF43	5A	Air Conditioner compressor、Pedestrian alert
UF44	5A	PTC、Blower relay

2.2.2 Relay information sheet

Relay	Specifications (A)	Functions
RLY01	SPARE	SPARE
RLY02	40A	Blower high speed relay
RLY03	40A	Blower relay
RLY04	40A	Vacuum pump relay
RLY05	40A	Cooling fan relay
RLY06	40A	Main relay
RLY07	40A	Rearview mirror heating relay
RLY08	30A	Right front daylight relay
RLY09	30A	Left Front row lamp relay
RLY10	30A	IGN Relay

保险丝盒 2-12

Relay	Specifications (A)	Functions
RLY11	30A	Wiper motor relay
RLY12	SPARE	SPARE
RLY13	30A	Horn relay

2.3 Instrument fuse box

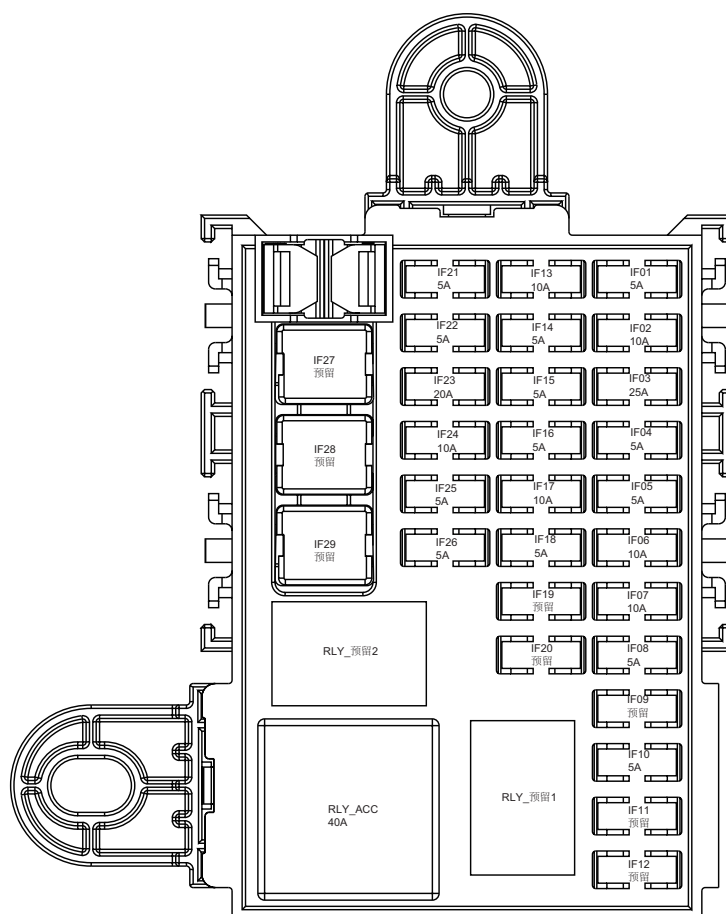

2.3.1 Fuse information sheet

Fuse box	Specifications	Functions
IF01	10A	AC CONTROL PANEL
IF02	10A	ADAS/Driving Video Recorder/RF MODULE/REAR CAMERA
IF03	7.5A	SPARE
IF04	5A	I-FS4 RLS/SOLAR & LIGHT SENSOR
IF05	5A	SPARE
IF06	10A	GEAR SHIFTER
IF07	5A	IGNITION SW/IMMO
IF08	5A	FIRE EXTINGUISHER SW
IF09	10A	REAR HOT BLOWER FB
IF10	10A	REAR BLOWER FB
IF11	25A	SPARE
IF12	15A	PEPS
IF13	5A	ADAS/RF MODULE/REAR PTC/DVR EU KL15
IF14	10A	PEB/CDU/VCU/BMS/AVAS KL15
IF15	5A	EPS KL15
IF16	10A	ACU

Fuse box	Specifications	Functions
IF17	10A	IPC/GATEWAY/PEPS KL15
IF18	5A	ABS/ESP KL15
IF19	10A	AT/AMT/GEAR SHIFTER KL15
IF20	10A	FRT/RR A/C PANEL/HEADLAMP LEVELING SW /CENTER CONTROL SW/PDC/LCA/PTC_EV KL15
IF21	10A	BLOWER FEEDBACK SIG
IF22	10A	OSRVM HEATING
IF23	10A	OBD
IF24	10A	OSRVM ADJ/RADIO/Driving Video Recorder/FRT&REAR BLOWER/PEPS/REAR HOT BLOWER/ECALL ACC
IF25	15A	CIGAR LIGHTER ACC
IF26	10A	GATEWAY/BCM/VCU ACC
IF27	10A	SPARE
IF28	7.5A	SPARE
IF29	10A	SPARE
IF30	10A	SPARE
IF31	25A	SPARE
IF32	10A	SPARE
IF33	10A	SPARE
IF34	10A	SPARE

2.3.2 Relay information sheet

Relay	Specifications (A)	Functions
IR01	-	ECALL MUTE
IR02	-	IG1
IR03	-	ACC relay
IR04	-	REAR DEFROST
IR05	-	SPARE
IR06	-	SPARE
IR07	-	SPARE

4.1 Engine compartment wiring harness

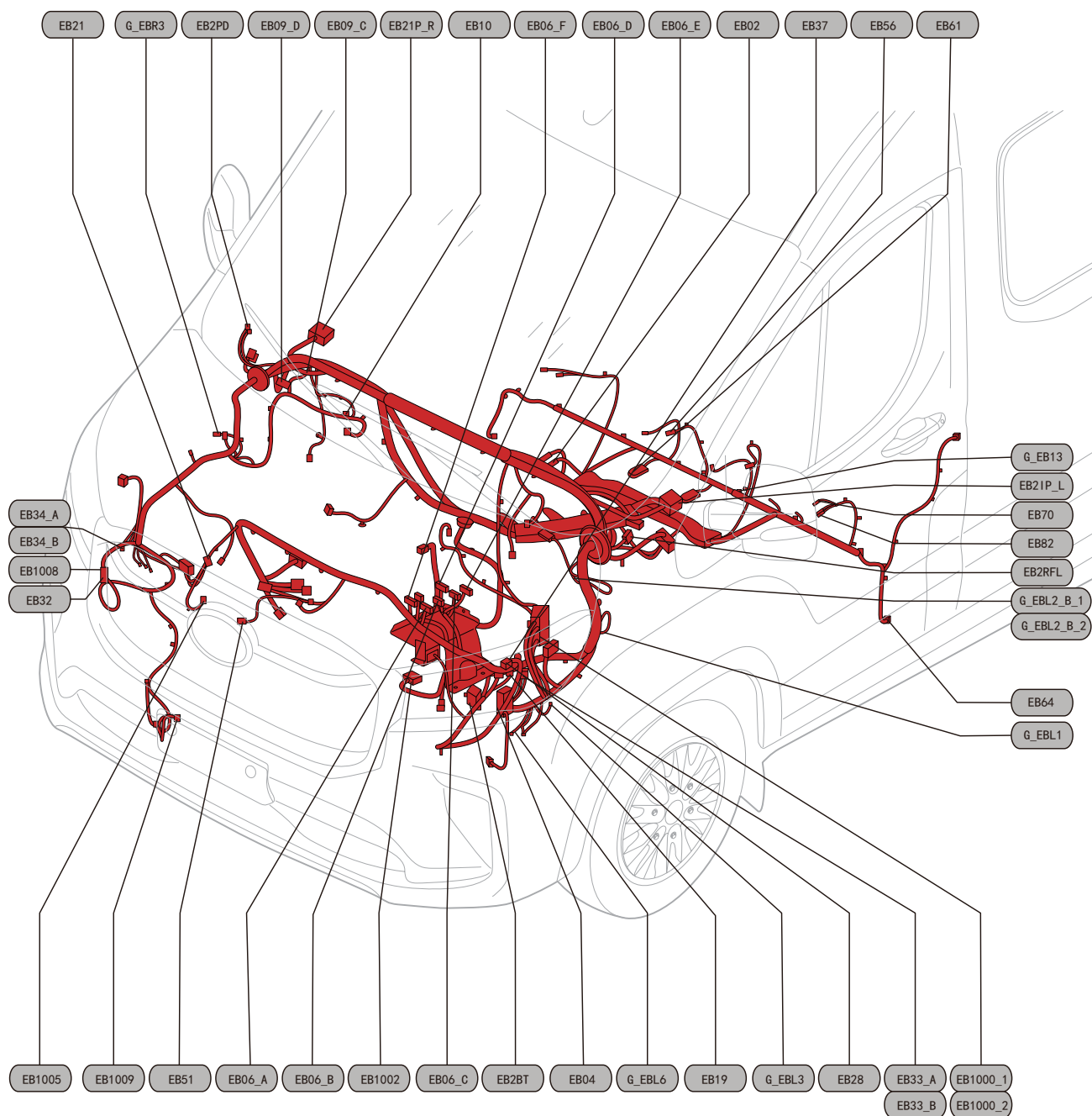

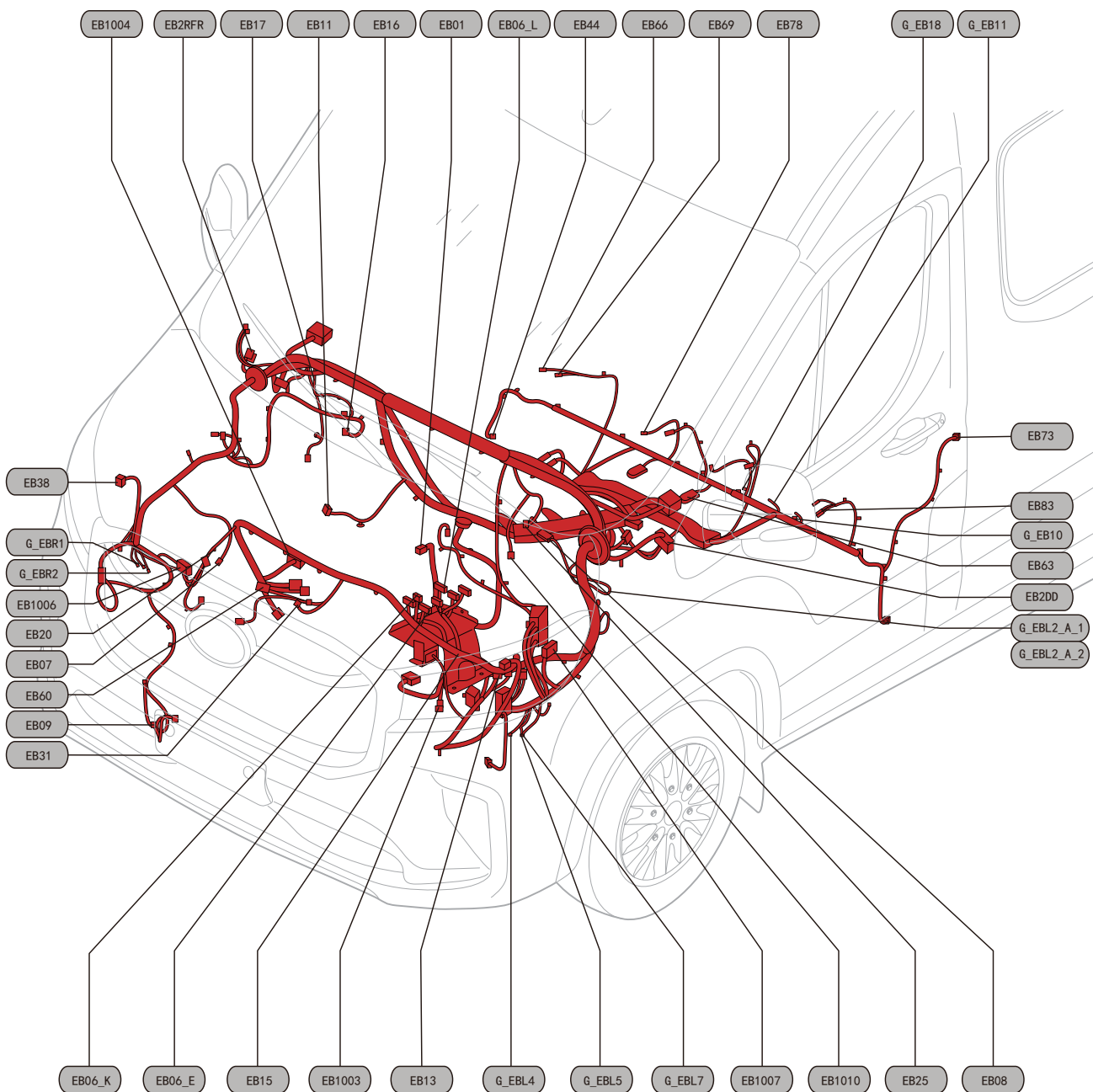

4.1.1 Engine compartment wiring harness EB plug-in description

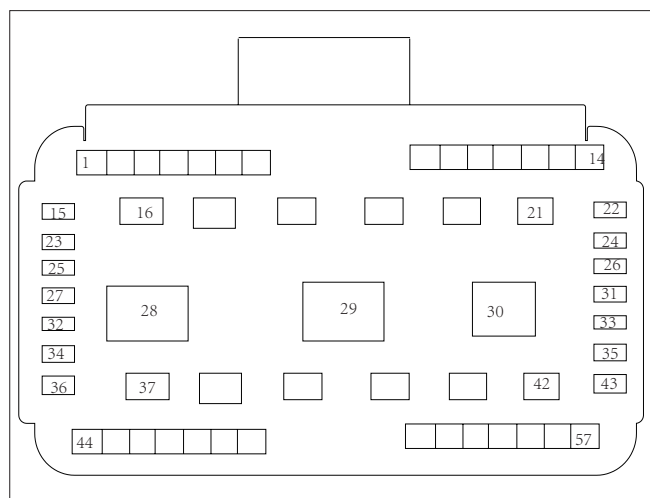

EB21P-R 接仪表线束 R
ASM CONN 57 M 0.64X42 GET

Pin No.	Color	Functions	Re- marks
1	D-BU	Power supply	
2	D-BU/YE	CAN-H	
3	D-GN	HI BEAM PWR(HI)	
4	VT	FL TURN FAULT FEEDBACK	
5	D-GN/ WH	FR TURN FAULT FEEDBACK	
6	RD/BN	Main Beem_Right (High)	
7	D-BU/ L-GN	CAN-L	
8	YE	FRONT_WIPER_ PARK_SW	
9	BN	HOOD SW	
10	BK	Earthing	
11	BARE	CAN-H	
12	OG/D-GN	ANT+	
13	OG/WH	ANT-	
14	L-BU	Power supply	
15	-	-	
16	D-BU	TURN PWR	

Pin No.	Color	Functions	Re- marks
17	WH	Power supply	
18	L-BU	Power supply	
19	L-GN/GY	Power supply	
20	VT/D-GN	Power supply	
21	OG/WH	OUTPUT	
22	YE	IGN1	
23	D-GN/RD	ANT+	
24	BN	DOOR_AJAR_RR_ SW	
25	D-GN	ANT-	
26	-	-	
27	WH/D-BU	Crash Output	
28	-	-	
29	-	-	
30	-	-	
31	OG	TEMP_AMB	
32	L-GN	FAD+	
33	VT	FAP+	
34	VT/D-GN	FAD-	
35	GY	FAP-	
36	YE	5V Power supply	
37	-	-	
38	-	-	
39	-	-	
40	GY	OUTPUT_2	
41	BK/RD	SIG_1	
42	WH/GY	SIG_2	
43	BK/WH	SGND	
44	D-BU/OG	CAN_H	
45	D-BU/BK	CAN_L	
46	-	-	
47	D-BU/RD	CAN_H	
48	D-BU/BN	CAN_L	
49	VT/D-GN	LIN2	
50	-	-	

Pin No.	Color	Functions	Re- marks
51	-	-	
52	-	-	
53	BRAN	Shielding wire	
54	D-BU/YE	CAN_H	
55	D-BU/ L-GN	CAN_L	
56	D-BU/VT	CAN_H	
57	D-BU/GY	CAN_L	

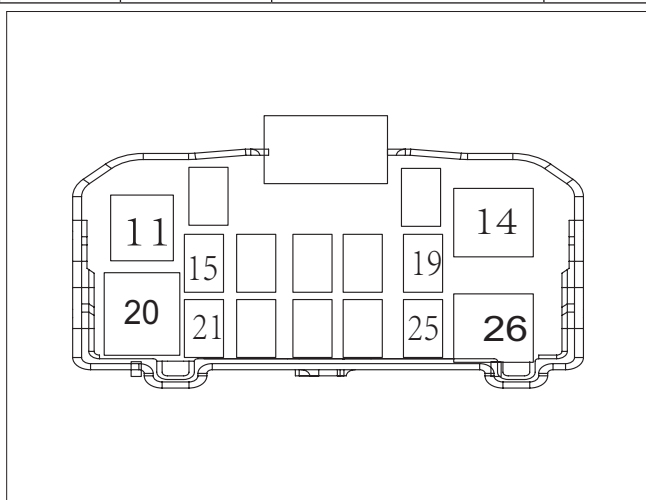

EB2PD 接门线束
CONN 16 F 1.5 2.8 NAT

Pin No.	Color	Functions	Re- marks
11	VT	CDL_LOCK_ MOTORS	
12	-	-	
13	-	-	
14	WH	UNLOCK	
15	-	-	
16	-	-	
17	VT	AUDIO RF+	
18	GY	AUDIO RF-	
19	RD/WH	LCA_LED+	
20	RD/WH	Power supply	
21	-	-	
22	-	-	

Pin No.	Color	Functions	Re- marks
23	-	-	
24	-	-	
25	BK	接地	
26	BK	接地	

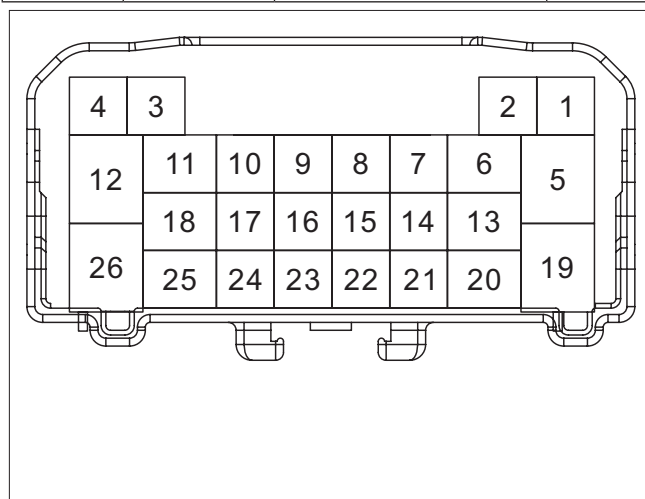

EB2RFR 接顶棚线束
ENGINE BAY TO ROOF RH INLINE

Pin No.	Color	Functions	Re- marks
1	WH	BRAKE_LAMPS_A	
2	BN	POSITION_LAMPS	
3	D-GN	REAR_FOG_ LAMPS	
4	L-GN	SNR-PWR	
5	-	-	
6	VT	CAN_H	
7	RD	CUR+	
8	BK	CUR-	
9	GY	AUDIO RF-	
10	VT	AUDIO RF+	
11	L-GN	CDL_TRUNK_ UNLOCK MOTOR	
12	-	-	
13	-	-	
14	RD/BK	LCA_LED+	
15	RD/WH	LCA_LED-	

Pin No.	Color	Functions	Re- marks
16	BK/RD	SEN-FL	
17	GY	SNR GND	
18	-	-	
19	-	-	
20	-	-	
21	YE	Power supply	
22	BN/GY	SEN-FLM	
23	D-BU/YE	SEN-FRM	
24	OG/WH	SEN-FR	
25	-	-	
26	-	-	

Pin No.	Color	Functions	Re- marks
9	RD/D-GN	电源	
10	L-GN	ESP OFF SIG	
11	WH	ESP OFF IND	
12	D-BU/WH	MOTOR SIG	
13	RD/D-BU	MOTOR PWR	
14	RD/WH	电源	
15	YE	电源	
16	RD	电源	
17	RD	电源	
18	VT/D-GN	TURN_LAMPS_L	
19	D-GN/GY	LIN	
20	-	-	
21	-	-	
22	YE	IG1	
23	D-BU	INTERNAL_LAMP_ POWER_OUT	
24	-	-	
25	-	-	
26	VT/D-GN	VSO	
27	RD/BK	电源	
28	RD	电源	
29	L-GN	M+	
30	RD	电源	
31	WH	IGN	
32	D-BU	POWER	
33	L-GN	SIG	
34	YE	HORN_RELAY	
35	VT	RAP	
36	L-GN	SIG OUT	
37	RD/BK	电源	
38	RD/D-GN	电源	
39	D-BU	CAN_H	
40	GY/WH	CAN_L	
41	-	-	

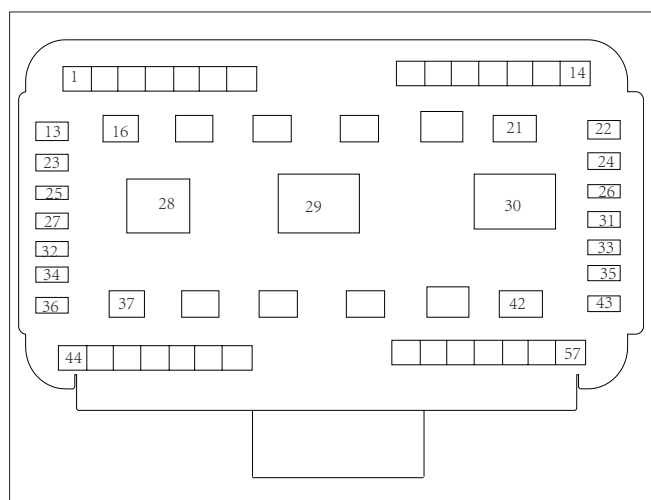

EB2IP_L 接仪表线束 L

ASM CONN 57 M 0.64X42 GET 2.8X12 6.3X3

Pin No.	Color	Functions	Re- marks
1	VT	VIN-1	
2	D-BU	Signal-1	
3	BK	接地	
4	GY/VT	AVAS SIG	
5	PK/WH	AVAS Indicator	
6	L-GN/YE	CAN_L	
7	L-GN/BK	CAN_H	
8	D-GN/GY	LIN	

Pin No.	Color	Functions	Re- marks
42	-	-	
43	YE/WH	B+	
44	OG/BK	CAN_H	
45	OG/L-GN	CAN_L	
46	BARE	屏蔽线	
47	BN/L-BU	CAN_H	
48	BN/VT	CAN_L	
49	BARE	屏蔽线	
50	D-BU	电源	
51	YE/BK	CAN_H	
52	YE/GY	CAN_L	
53	BARE	屏蔽线	
54	VT	R-PRESS_SENS	
55	OG	电源	
56	D-BU	REVERSE LAMPS	
57	VT/D-GN	电源	

Pin No.	Color	Functions	Re- marks
14	BK	接地	
15	-	-	
16	-	-	
17	D-BU	AUDIO LF+	
18	YE	AUDIO LF-	
19	RD/BK	LCA_LED+	
20	RD	电源	
21	-	-	
22	-	-	
23	-	-	
24	-	-	
25	BK	接地	
26	BK	接地	

51

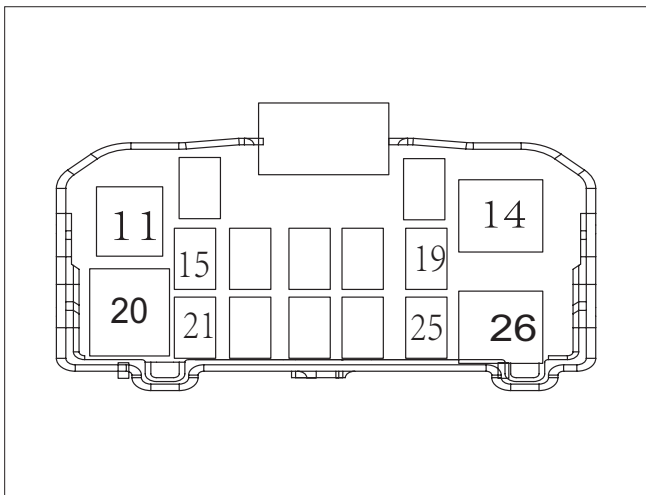

EB2DD 接门线束
CONN 16 F 1.5 2.8 NAT

Pin No.	Color	Functions	Re- marks
11	VT	CDL_LOCK_MOTORS	
12	-	-	
13	-	-	

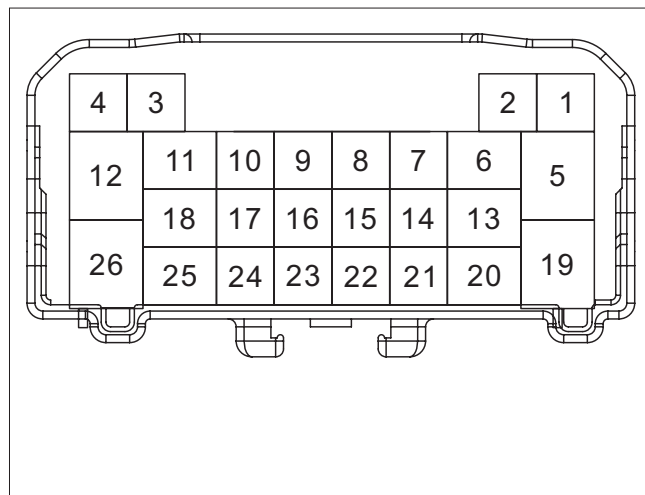

EB2RFL 接顶棚线束 L
ASM CONN 26 M 0.64 1.5 2.8

Pin No.	Color	Functions	Re- marks
1	-	-	
2	-	-	
3	D-BU/RD	CAN_H	
4	D-BU/BN	CAN_L	
5	BN	M+	
6	L-BU	Sensor supply(+)	

Pin No.	Color	Functions	Re- marks
7	VT	FRONT_ INTERNAL_LAMP_ CTRL	
8	WH	Sensor supply(-)	
9	D-BU	AUDIO LF+	
10	YE	AUDIO LF-	
11	GY/BK	singal(real time)	
12	-	-	
13	YE	I/O data signal	
14	L-GN	CUL+	
15	VT/D-GN	CUL-	
16	D-BU/WH	CAN_H	
17	D-BU/ D-GN	CAN_L	
18	VT/YE	I/O data signal	
19	-	-	
20	D-GN	REAR_ INTERNAL_ LAMP	
21	WH	BRAKE_ LAMPS_ A	
22	BN	POSITION_ LAMPS	
23	D-GN	REAR_ FOG_ LAMPS	
24	D-BU	INTERNAL_LAMP_ POWER OUT	
25	-	-	
26	-	-	

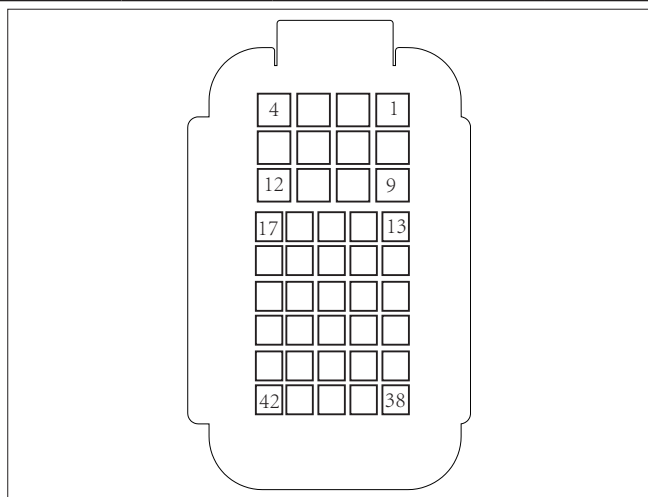

EB2CH 接底盘线束

CONN 42 M936429-2TYCO

Pin No.	Color	Functions	Re- marks
1	OG/BN	Interlock	
2	WH/BK	SIG	
3	WH/RD	PWR	
4	-	-	
5	-	-	
6	RD/D-BU	SIG	
7	RD/BK	PWR	
8	-	-	
9	RD/YE	电源	
10	YE/BK	TemL2 +	
11	YE/BN	TemL3 +	
12	YE	电源	
13	BN/L-BU	CAN_H	
14	BN/VT	CAN_L	
15	BARE	屏蔽线	
16	OG/YE	LOCKING	
17	WH	CP	
18	YE	CC	
19	PK	DC12V+	
20	BK	DC12V-	
21	OG/BN	Tem DC++	
22	OG/BK	UNLOCKING	
23	L-GN/BN	LOCKING SIG	
24	YE/RD	Tem L1+	
25	OG/BK	CAN_H	
26	OG/L-GN	CAN_L	
27	BARE	屏蔽线	
28	WH/D-BU	Crash_PWM	
29	-	-	
30	WH	positive relay +	
31	WH/RD	negative relay+	
32	L-GN/YE	HVIL_IN	
33	OG/L-GN	temp_DC+/-	

线束分布及电器元件引脚定义 4-22

Pin No.	Color	Functions	Re- marks
34	YE/VT	temp_DC-+	
35	BN/L-BU	CAN_H	
36	BN/VT	CAN_L	
37	BARE	屏蔽线	
38	YE	电源	
39	YE/WH	CC2	
40	D-BU/YE	CAN_H	
41	D-BU/ L-GN	CAN_L	
42	BARE	屏蔽线	

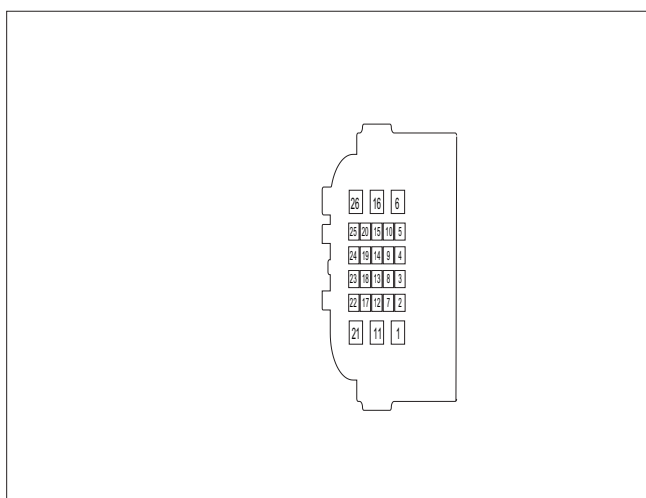

EB2BT 接蓄电池线束
PP0302905 THB

Pin No.	Color	Functions	Re- marks
1	RD/VT	电源	
2	L-GN/YE	HVIL_IN	
3	OG/BN	HVIL_OUT	
4	OG/BN	电源	
5	D-GN/GY	LIN	
6	RD/D-GN	PWR	
7	4004A	PWM	
8	OG	电源	
9	OG/WH	I_A_TEMP	
10	D-BU/WH	G_R_TEMP	

Pin No.	Color	Functions	Re- marks
11	-	-	
12	D-BU/WH	CAN_H	
13	D-BU/ D-GN	CAN_L	
14	D-BU/WH	CAN_H	
15	D-BU/ D-GN	CAN_L	
16	-	-	
17	L-BU	Sensor supply(+)	
18	WH	Sensor supply(-)	
19	GY/BK	signal(real time)	
20	VT/YE	I/O data signal	
21	-	-	
22	-	-	
23	-	-	
24	-	-	
25	-	-	
26	-	-	

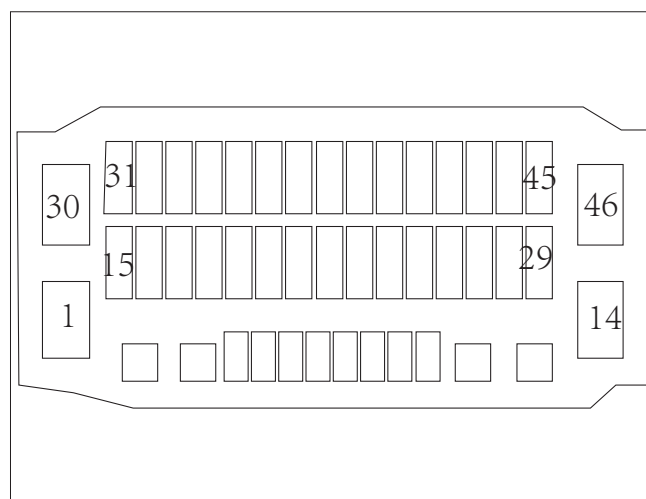

EB04 ABS/ESP
ASM CONN 46 F CTS 280 480 OCS 1.2 SLD

Pin No.	Color	Functions	Re- marks
1	RD/WH	电源	
2	-	-	

Pin No.	Color	Functions	Re- marks
3	-	-	
4	-	-	
5	D-BU/WH	CAN_H	
6	-	-	
7	D-BU	SIG	
8	-	-	
9	VT/D-BU	VSO	
10	WH	ESP OFF IND	
11	-	-	
12	-	-	
13	-	-	
14	BK/WH	GND	
15	-	-	
16	-	-	
17	-	-	
18	-	-	
19	D-BU/ D-GN	CAN_L	
20	-	-	
21	VT	WSP_FR	
22	RD/BK	WSP_RR	
23	WH/BK	SIG	
24	BN	PWR	
25	-	-	
26	D-GN	SIG	
27	-	-	
28	-	-	
29	-	-	
30	RD/WH	电源	
31	-	-	
32	-	-	
33	-	-	
34	-	-	
35	-	-	

Pin No.	Color	Functions	Re- marks
36	RD/D-GN	PWR_IGN	
37	RD/D-BU	SIG	
38	-	-	
39	WH/RD	PWR	
40	-	-	
41	-	-	
42	-	-	
43	L-GN	ESP_OFF(ESP)	
44	-	-	
45	-	-	
46	BK	接地	

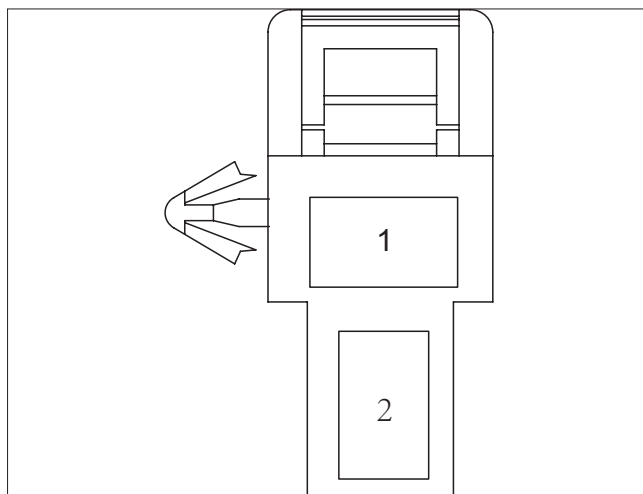

EB05 TIRE REPAIR
CONN 2 M 250 NAT

Pin No.	Color	Functions	Re- marks
1	RD/WH	电源	
2	BK	接地	

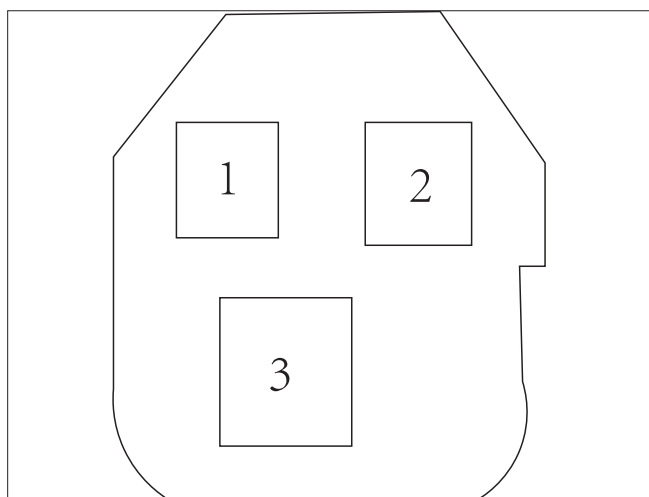

EB07 洗涤电机
ASM CONN 3 F 090 II GRA SLD WP

Pin No.	Color	Functions	Re- marks
1	BK	接地	
2	D-BU	电源	
3	-	-	

Pin No.	Color	Functions	Re- marks
4	BK	接地	
5	BN	慢速	

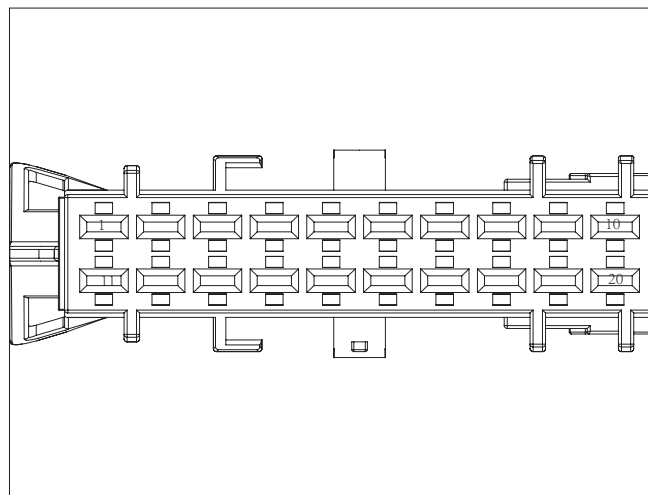

EB09-C BCM J3
ASM CONN 20 F CTS 280

Pin No.	Color	Functions	Re- marks
1	WH	UNLOCK	
2	BK	接地	
3	RD	电源	
4	BK	接地	
5	L-GN	CDL_TRUNK_UNLOCK MOTOR	
6	BK	接地	
7	RD/WH	电源	
8	D-BU	FRT WASH	
9	RD/WH	电源	
10	BK	接地	
11	VT	LOCK	
12	-	-	
13	-	-	
14	RD/YE	电源	
15	BK	接地	
16	GY	FRT WIPER HIGH	
17	BN	FRT WIPER LOW	

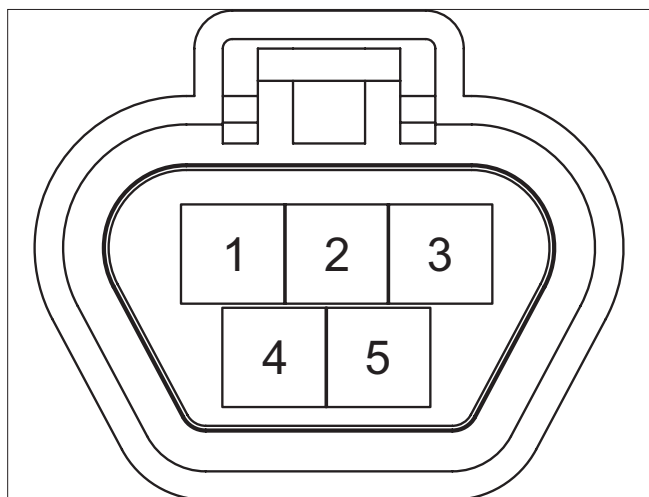

EB08 前雨刮电机
CONN 5 F GRA

Pin No.	Color	Functions	Re- marks
1	YE	PARK	
2	-	-	
3	GY	高速	

Pin No.	Color	Functions	Re- marks
18	-	-	
19	-	-	
20	-	-	

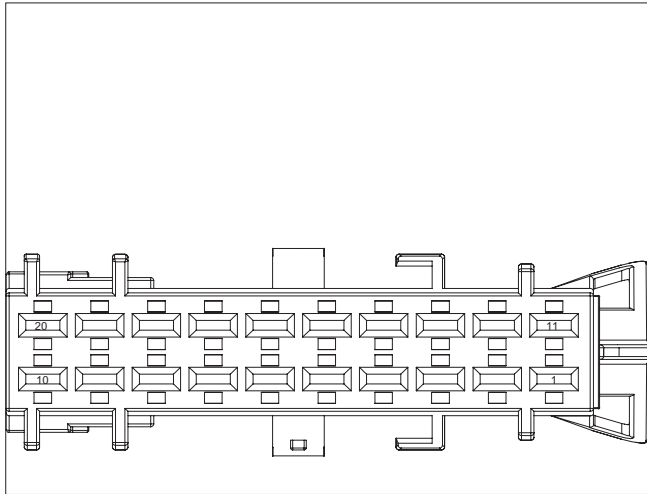

EB09-D BCM J
ASM CONN 20 F CTS 280

Pin No.	Color	Functions	Re- marks
1	RD	电源	
2	BN	POSITION_LAMPS	
3	GY/D-BU	MainBeam_Left(LO/ MID)	
4	BK	接地	
5	D-BU	INTERNAL_LAMP_ POWER OUT	
6	RD	电源	
7	RD	电源	
8	WH	BRAKE_LAMPS_A	
9	D-BU	电源	
10	RD/BK	电源	
11	-	-	
12	D-GN	REAR_INTERNAL_ LAMP	
13	GY	HI BEAM PWR(LO/ MID)	

Pin No.	Color	Functions	Re- marks
14	D-GN	REAR FOG	
15	VT	FRONT_ INTERNAL_LAMP_ CTRL	
16	OG	DIPPED_BEAM_LH	
17	-	-	
18	-	-	
19	BN/GY	DIPPED_BEAM_ RH	
20	RD/BK	电源	

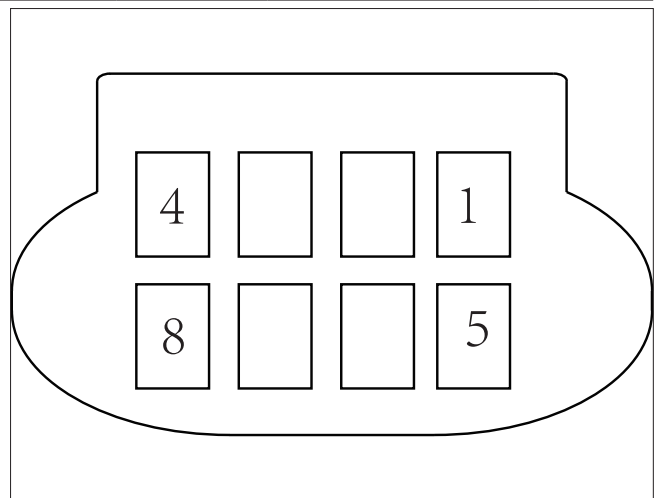

EB10 后空调压缩机
ASM CONN 8 F 1.2 BLK SLD

Pin No.	Color	Functions	Re- marks
1	OG/BN	电源	
2	D-GN/GY	LIN	
3	BK	接地	
4	-	-	
5	-	-	
6	OG/BN	HVIL_OUT	
7	OG/BN	HVIL_OUT	
8	-	-	

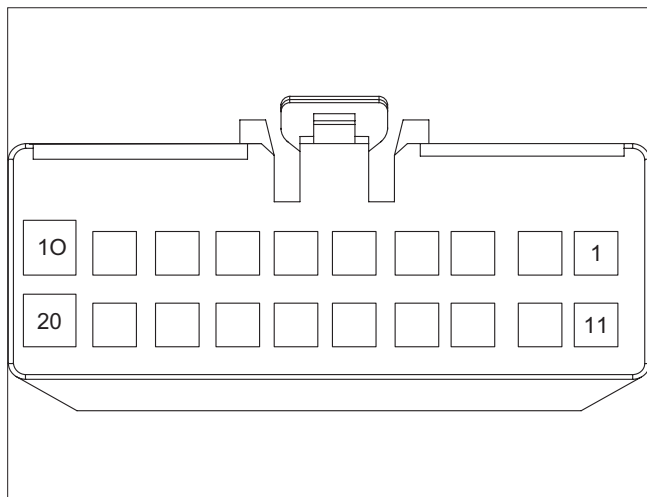

EB11_A 网关
1-2299987-2 AMP

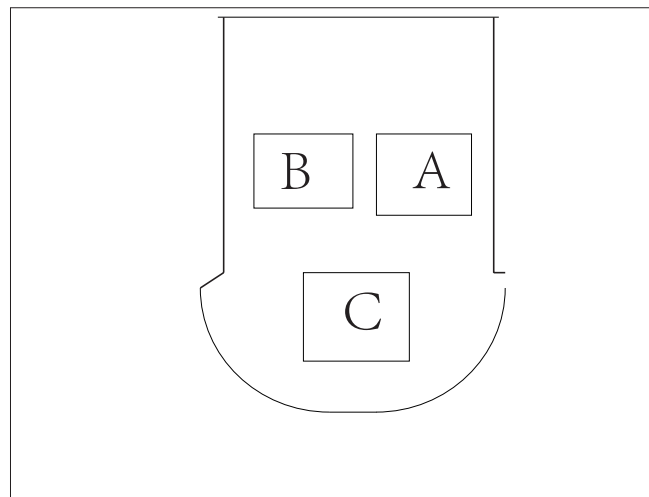

EB13 前空调压力传感器
ASM CONN 3 F M/P 150 P2S BLK SLD

Pin No.	Color	Functions	Re- marks
1	D-BU/VT	CAN_H	
2	D-BU/WH	CAN_H	
3	D-BU/RD	CAN_H	
4	D-BU/YE	CAN_H	
5	D-BU/OG	CAN_H	
6	-	-	
7	-	-	
8	-	-	
9	-	-	
10	RD/WH	电源	
11	D-BU/GY	CAN_L	
12	D-BU/ D-GN	CAN_L	
13	D-BU/BN	CAN_L	
14	D-BU/ L-GN	CAN_L	
15	D-BU/BK	CAN_L	
16	-	-	
17	-	-	
18	YE	电源	
19	RD/WH	电源	
20	BK	接地	

Pin No.	Color	Functions	Re- marks
A	BK/WH	SGND	
B	YE	REF_5V	
C	L-GN	SIG OUT	

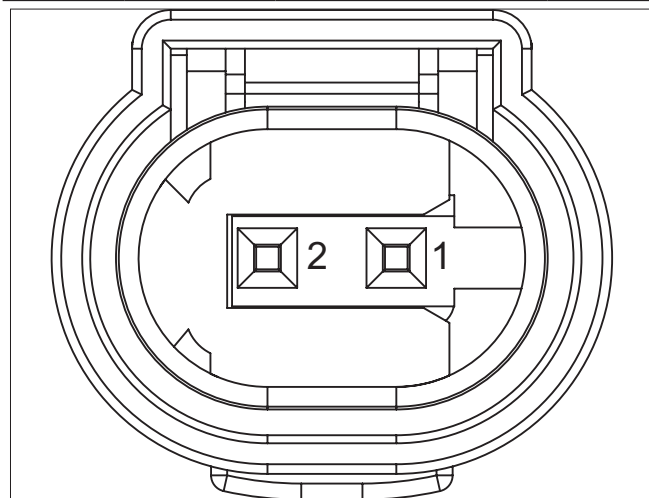

EB15 左前轮速传感器
ASM CONN 2 F 0.64 MQS BLK SLD

Pin No.	Color	Functions	Re- marks
1	D-BU	传感器 -	
2	BN	传感器 +	

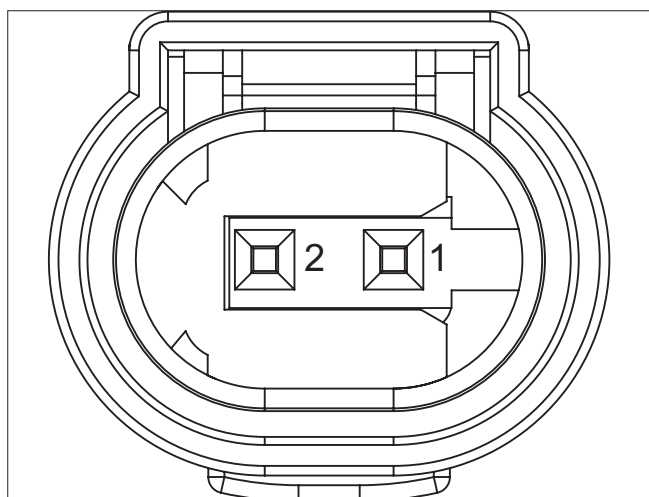

EB16 右前轮速传感器
ASM CONN 2 F 0.64 MQS BLK SLD

Pin No.	Color	Functions	Re- marks
1	D-GN	传感器 -	
2	VT	传感器 +	

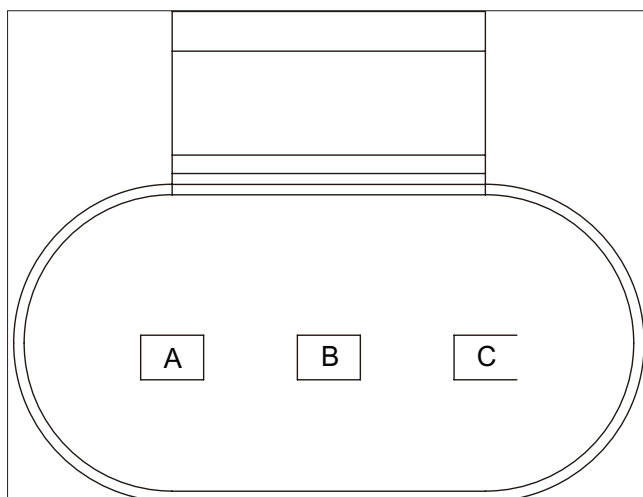

EB20 散热风扇 (300W)
CONN 3 F M/P 630 BLK SLD

Pin No.	Color	Functions	Re- marks
A	YE	高速	
B	RD	低速	
C	BK	接地	

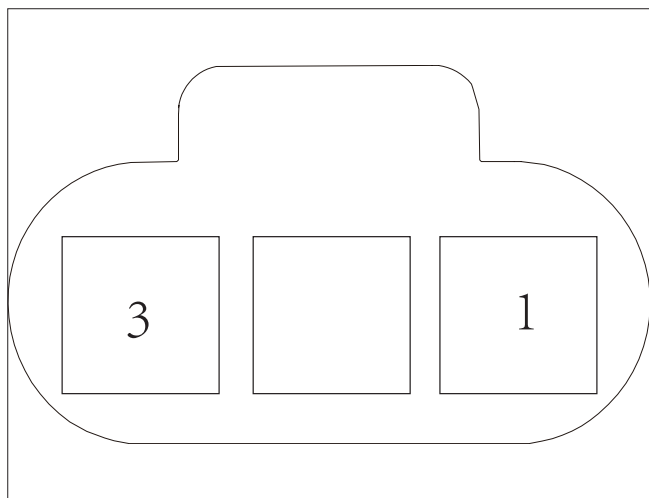

EB19 制动踏板传感器
ASM CONN 3 F 1.2 MCON-LL BLK SLD

Pin No.	Color	Functions	Re- marks
1	D-GN	信号	
2	BK	接地	
3	RD	电源	

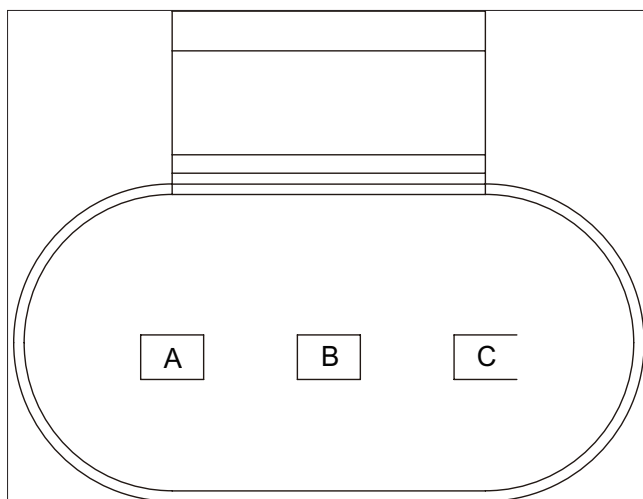

EB21 散热风扇 (400W)
CONN 3 F M/P 630 BLK SLD

Pin No.	Color	Functions	Re- marks
A	WH	高速	
B	RD	低速	
C	BK	接地	

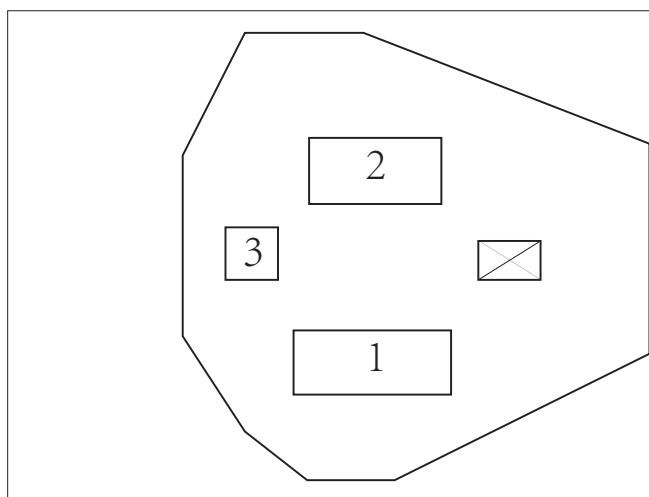

EB22 散热风扇 (550W)
ASM CONN 3 F 1.5 9.5 SLD BASE 4

Pin No.	Color	Functions	Re- marks
1	BK	接地	
2	RD/WH	电源	
3	-	-	
4	YE/BK	PWM	

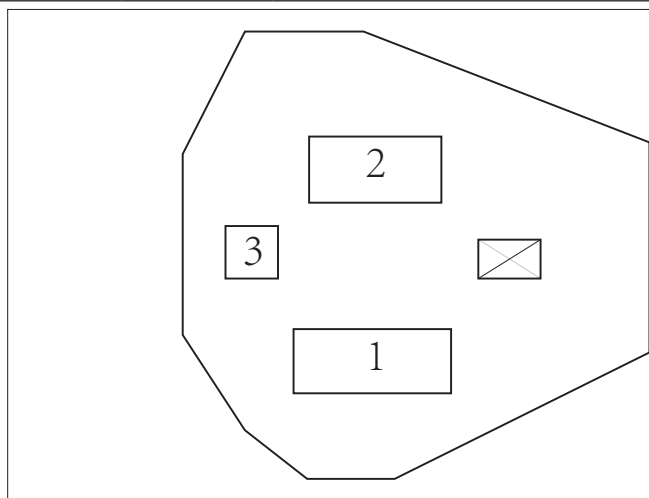

EB23 散热风扇 (450W)
ASM CONN 3 F 1.5 9.5 SLD BASE 4

Pin No.	Color	Functions	Re- marks
1	BK	接地	
2	RD	电源	
3	-	-	
4	WH	PWM	

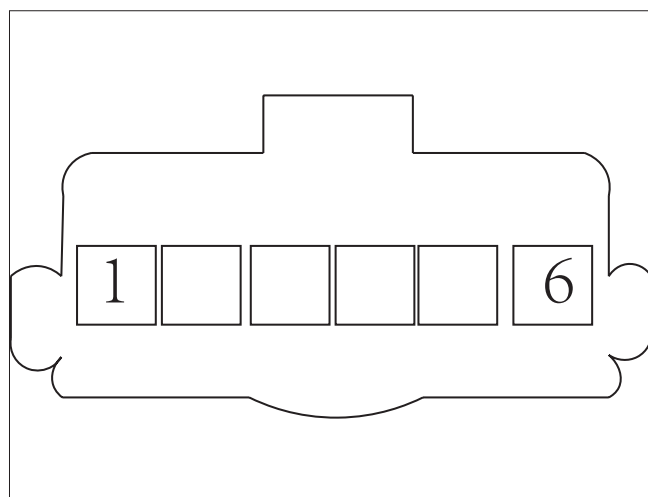

EB25 水温传感器
ASM CONN 6 F 064 BLK SLD

Pin No.	Color	Functions	Re- marks
1	RD/YE	电源	
2	WH/BK	接地 1	
3	YE/L-GN	信号 1	
4	RD/BN	电源	
5	BK/L-BU	接地 2	
6	L-GN/GY	信号 2	

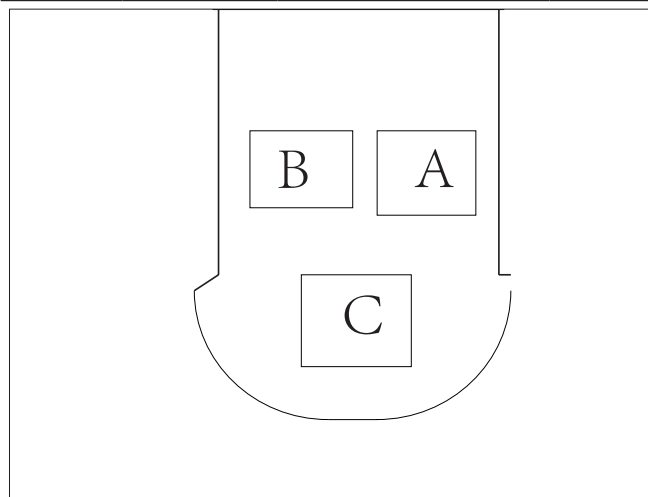

EB17 后空调压力传感器
ASM CONN 3 F M/P 150 BLK SLD

Pin No.	Color	Functions	Re- marks
A	BK/WH	SGND	
B	YE	5V	

Pin No.	Color	Functions	Re- marks
C	VT	R-PRESS_SENS	

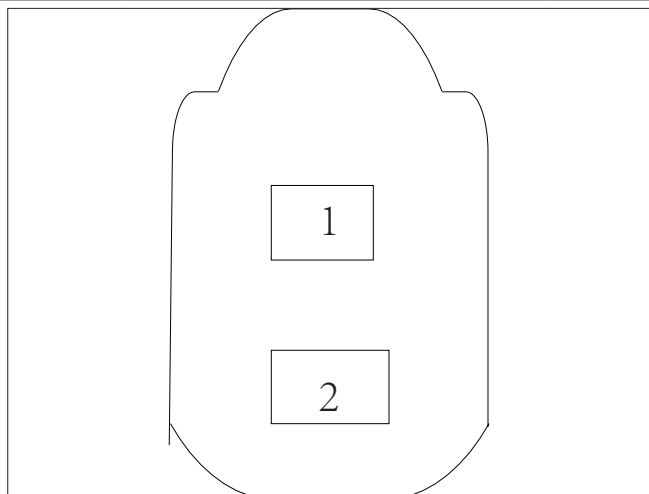

EB31 左前喇叭
ASM CONN 2 F GT 150 BLK SLD

Pin No.	Color	Functions	Re- marks
1	WH	电源	
2	BK	接地	

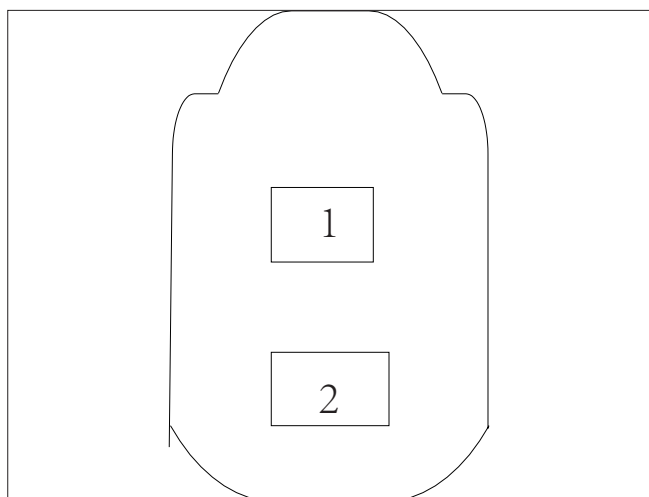

EB32 右前喇叭
ASM CONN 2 F GT 150 BLK SLD

Pin No.	Color	Functions	Re- marks
1	WH	电源	
2	BK	接地	

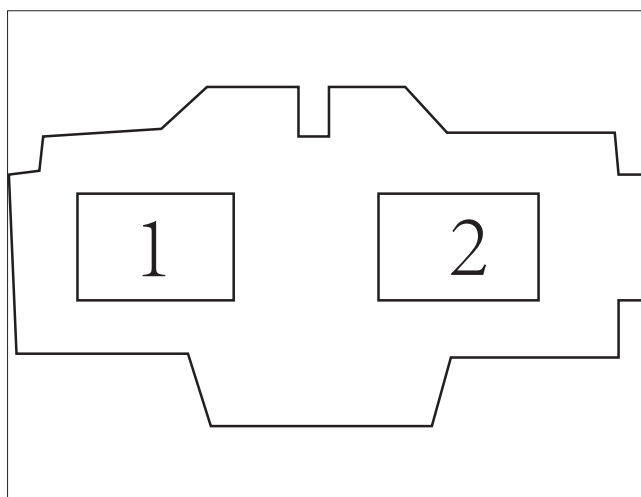

EB33 左前雾灯
CONN 2 F LP SOC WEDGE BLK SLD

Pin No.	Color	Functions	Re- marks
1	BK	接地	
2	YE	信号	

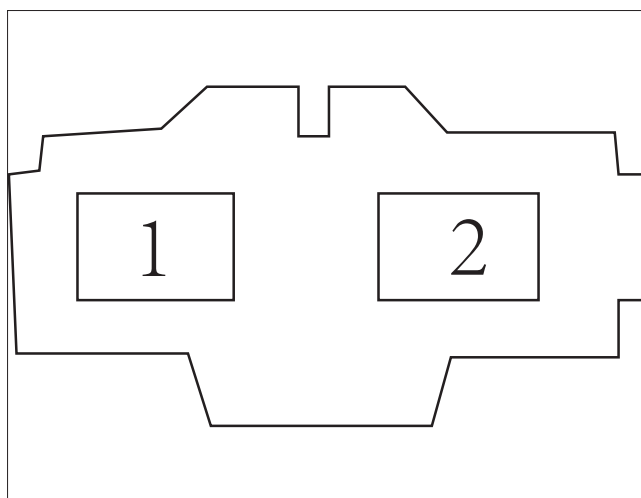

EB34 右前雾灯
CONN 2 F LP SOC WEDGE BLK SLD

Pin No.	Color	Functions	Re- marks
1	BK	接地	
2	YE	信号	

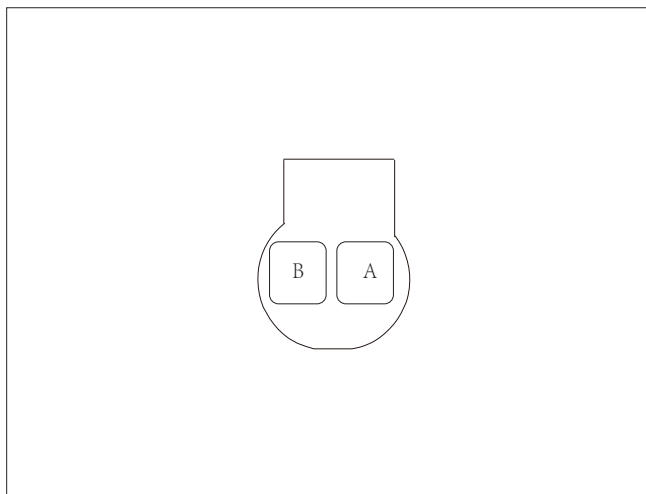

EB28 制动液位开关
ASM CONN 2 F MP 150.2 BLK SLD

Pin No	Color	Functions	Re- marks
6	D-BU	TURN PWR	
7	D-GN/ WH	TURN FAULT FEEDBACK	
8	BK	接地	
9	RD/D-BU	MOTOR PWR	
10	D-BU/WH	MOTOR SIG	
11	BK	接地	
12	OG	DRL PWR	
13	BN	POS PWR	
14	RD/BN	HI BEAM PWR(HI)	

Pin No.	Color	Functions	Re- marks
1	L-GN	电源	
2	BK	接地	

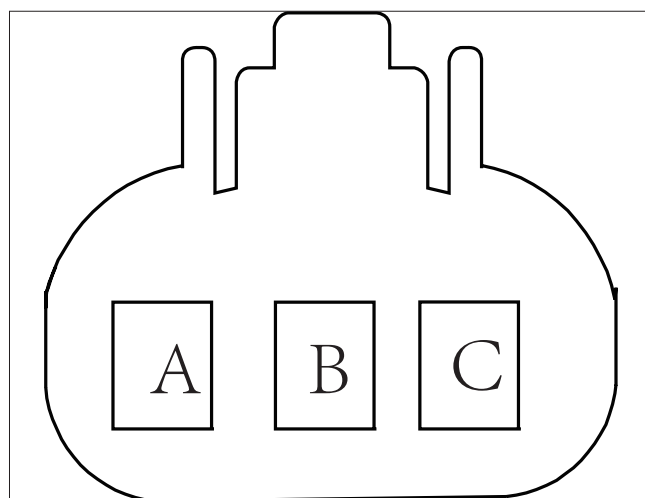

EB51 HOOD AJAR SW
ASM CONN 3 M GT 150 BLK SLD

Pin No	Color	Functions	Re- marks
A	BK	接地	
B	-	-	
C	BN	电源	

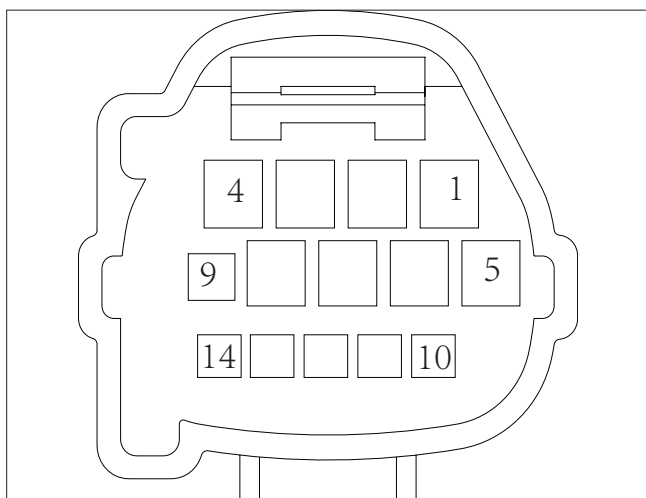

EB38 右前大灯
ASM CONN 14 F 025 060

Pin No	Color	Functions	Re- marks
1	BK	接地	
2	GY	HI BEAM PWR(LO/ MID)	
3	BK	接地	
4	BN/GY	LO BEAM	
5	BK	接地	

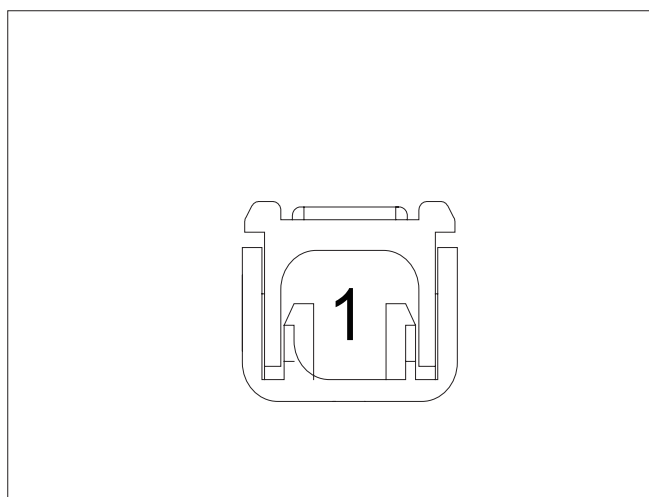

EB56 驻车制动开关
CONN 1 F 250 NAT

Pin No	Color	Functions	Re- marks
1	D-BU	电源	

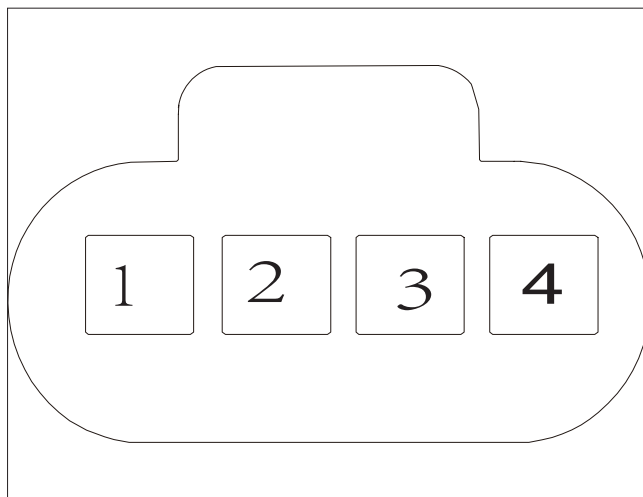

EB60 充电指示器
7123-4123-30 YAZAKI

Pin No	Color	Functions	Re- marks
1	VT/YE	Main Relay+	
2	L-GN/BK	R -	
3	YE/WH	G -	
4	VT/WH	B -	

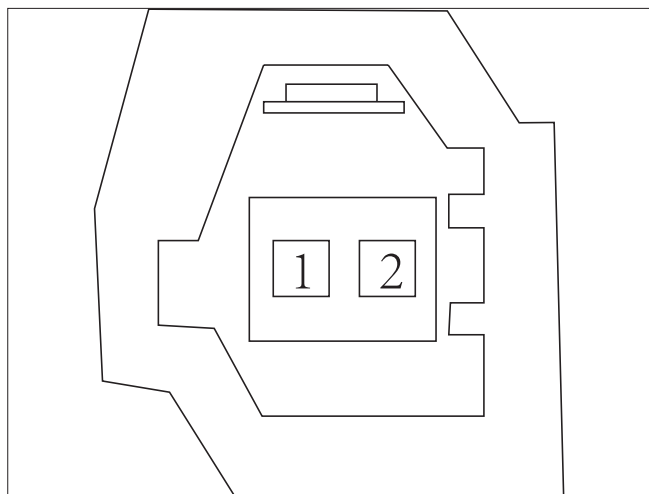

EB59 环境温度传感器
CONN 2F SEALED

Pin No	Color	Functions	Re- marks
1	BK/WH	接地	
2	OG	电源	

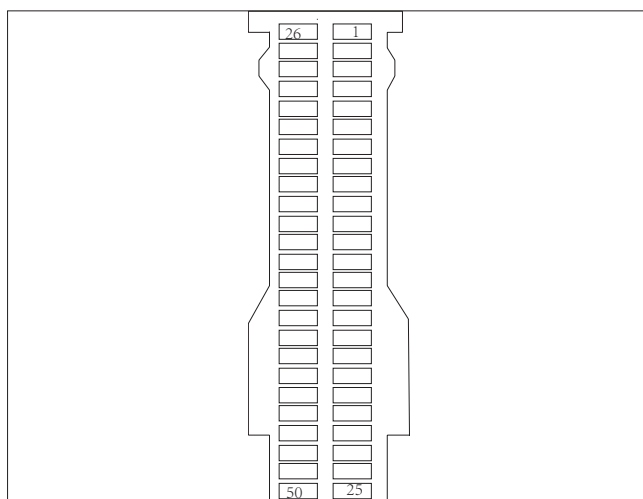

EB63 ACU
CONN 50 F 064 BRN

Pin No	Color	Functions	Re- marks
1	D-GN	SAD+	
2	L-BU	SAD-	
3	BN	SAP-	

Pin No	Color	Functions	Re- marks
4	D-BU	SAP+	
5	WH	IGN	
6	BK	接地	
7	OG	BSD	
8	-	-	
9	-	-	
10	L-GN	FAD+	
11	VT/D-GN	FAD0	
12	-	-	
13	VT	FAP+	
14	GY	FAP-	
15	-	-	
16	-	-	
17	-	-	
18	-	-	
19	-	-	
20	-	-	
21	-	-	
22	L-GN	CUL+	
23	VT/D-GN	CUL-	
24	BK	接地	
25	RD	CUR+	
26	L-GN	SIS_g_BP_Left+	
27	VT/D-GN	SIS_g_BP_Left-	
28	VT	SIS_g_BP_Right-	
29	GY	SIS_g_BP_Right+	
30	-	-	
31	-	-	
32	-	-	
33	D-BU/ L-GN	CAN_L	
34	D-BU/YE	CAN_H	
35	YE/RD	BS3L	
36	-	-	

Pin No	Color	Functions	Re- marks
37	-	-	
38	-	-	
39	-	-	
40	L-GN/RD	BSP	
41	-	-	
42	-	-	
43	-	-	
44	-	-	
45	-	-	
46	WH/D-BU	Crash Output	
47	-	-	
48	-	-	
49	-	-	
50	-	-	

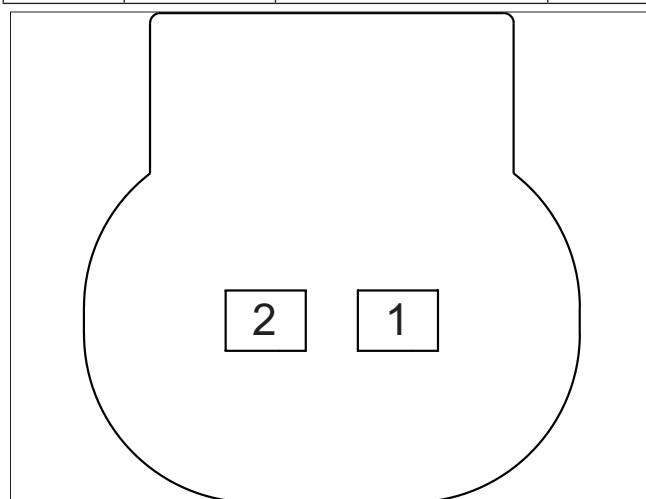

EB64 左碰撞传感器

ASM CONN 2 F 1.2 MCON-LL YEL SLD

Pin No	Color	Functions	Re- marks
1	L-GN	传感器 +	
2	VT/D-GN	传感器 -	

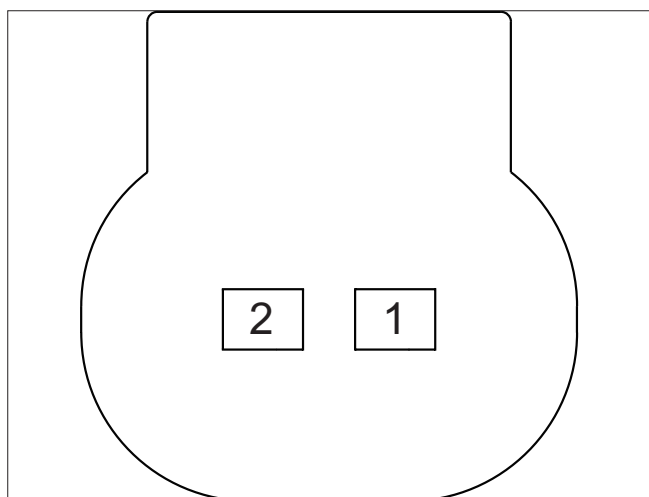

EB65 右碰撞传感器
ASM CONN 2 F 1.2 MCON-LL YEL SLD

Pin No	Color	Functions	Re- marks
1	GY	传感器 +	
2	VT	传感器 -	

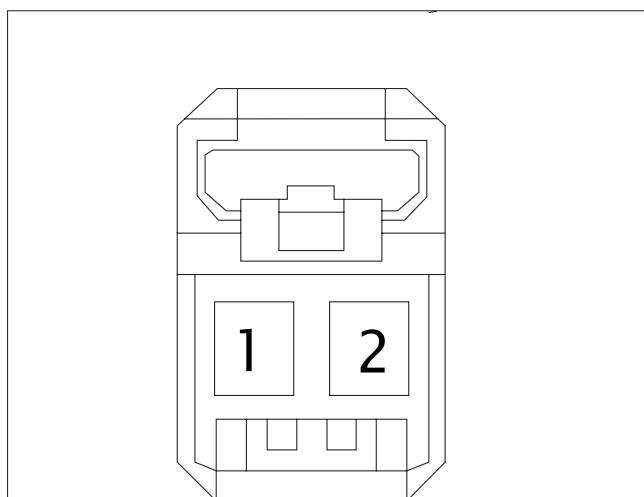

EB69 驾驶员侧气囊
CONN 2 F 2.1 YEL

Pin No	Color	Functions	Re- marks
1	D-GN	电源	
2	L-BU	接地	

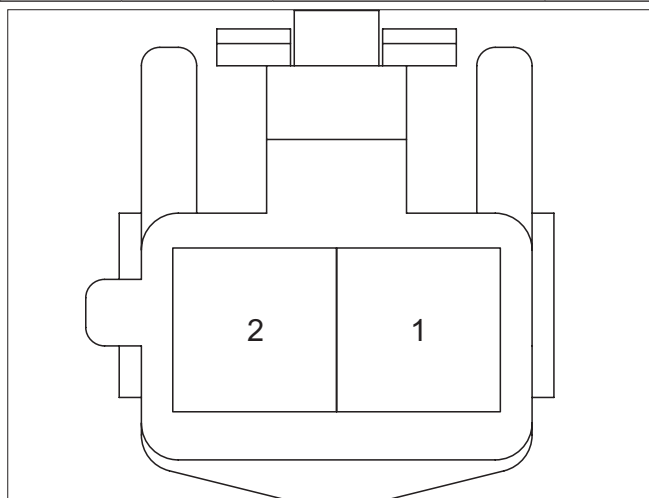

EB66 驾驶员安全带开关
ASM CONN 2 F 1.2 MCON-LL YEL SLD

Pin No	Color	Functions	Re- marks
1	OG	电源	
2	BK	接地	

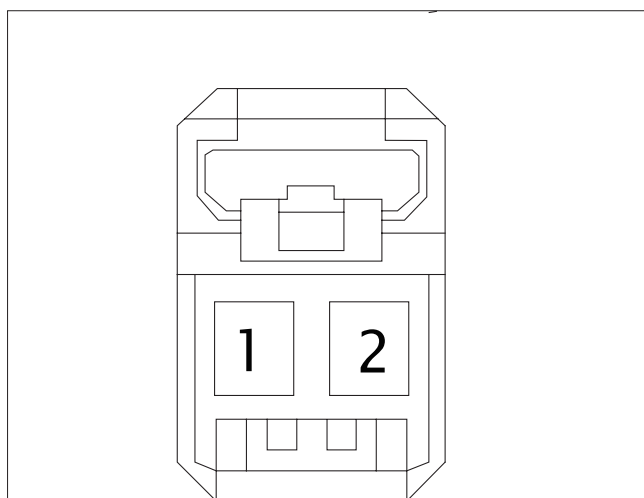

EB70 副驾侧气囊
CONN 2 F 2.1 YEL

Pin No	Color	Functions	Re- marks
1	D-BU	电源	
2	BN	接地	

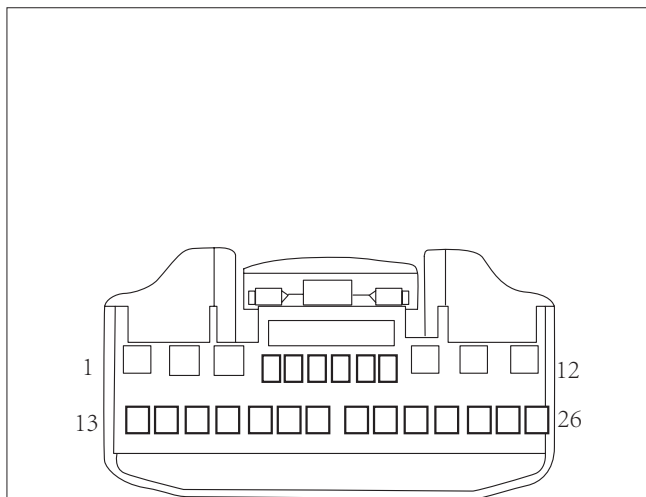

EB71 动力踏板组件
1-1563759-1 AMP

Pin No	Color	Functions	Re- marks
1	RD	PWR+	
2	GY	ELE STEP MTR-	
3	OG/VT	ELE STEP MTR+	
4	-	-	
5	-	-	
6	-	-	
7	VT/D-GN	LIN	
8	-	-	
9	-	-	
10	-	-	
11	-	-	
12	BK	接地	
13	GY	SNR PWR-	
14	D-BU	SNR SIG_A	
15	BN	SNR SIG_B	
16	D-GN	SNR PWR+	
17	-	-	
18	-	-	
19	-	-	
20	-	-	
21	-	-	
22	-	-	

Pin No	Color	Functions	Re- marks
23	-	-	
24	-	-	
25	-	-	
26	-	-	

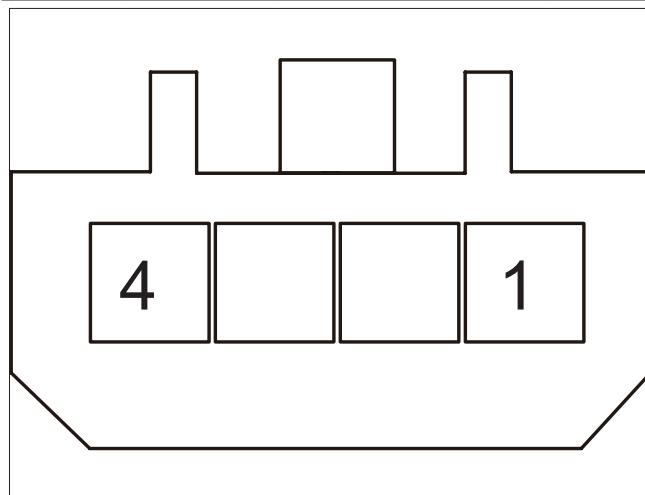

EB73 侧门触点开关
ASM CONN 4 F 090 II NAT

Pin No	Color	Functions	Re- marks
1	BN	DOOR AJAR	
2	VT	LOCK	
3	WH	UNLOCK	
4	B	接地	

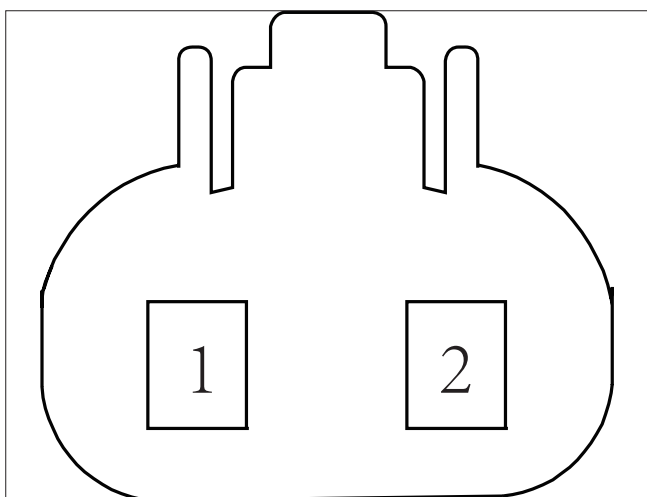

EB78 REAR ANT
CONN 2 F 070 SWP SLD NAT

Pin No	Color	Functions	Re- marks
1	D-GN/RD	ANT+	
2	D-GN	ANT-	

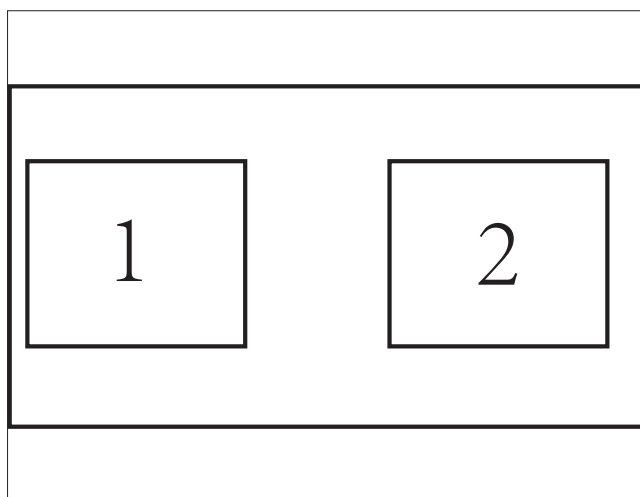

EB44_A 踏步灯
15326849 DELPHI

Pin No	Color	Functions	Re- marks
1	D-BU	电源	
2	VT	接地	

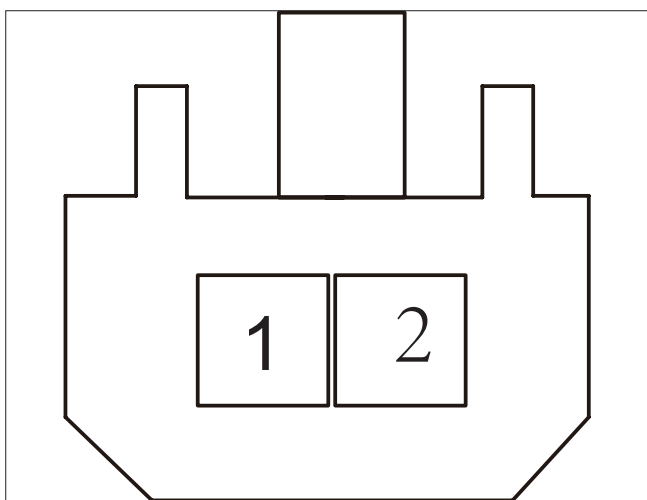

EB79 MIDDLE ANT
CONN 2 F 090 II NAT

Pin No	Color	Functions	Re- marks
1	OG/D-GN	ANT+	
2	OG/WH	ANT-	

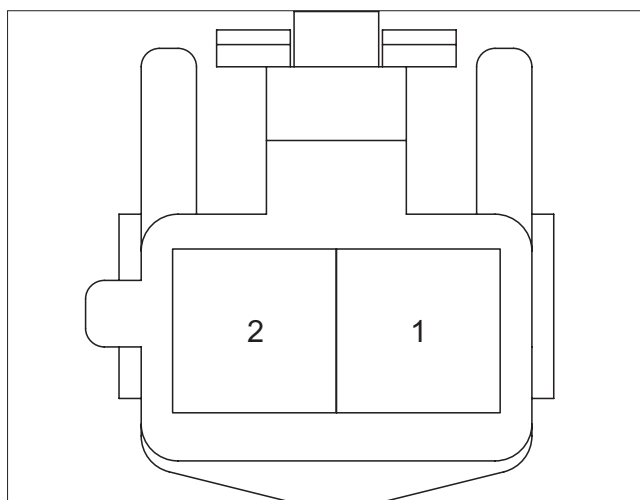

EB82 2sec PASS seat belt SW
15326849 DELPHI

Pin No	Color	Functions	Re- marks
1	YE/RD	电源	
2	D-BU/YE	接地	

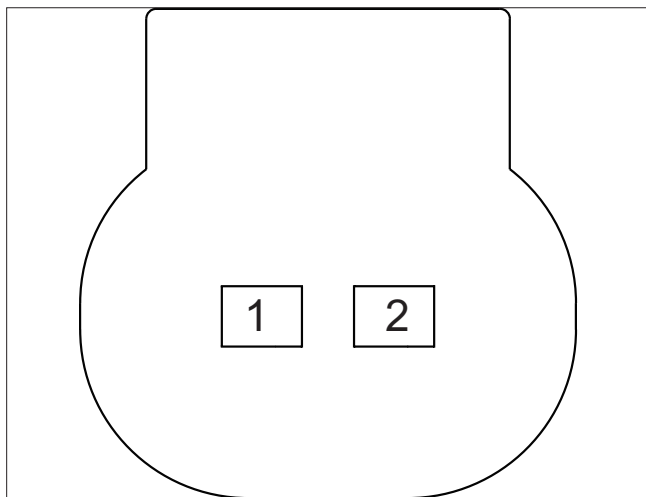

EB80_A 灭火器传感器
ASM CONN 2 F SUPERSEAL 1.5 BLK SLD

Pin No	Color	Functions	Re- marks
1	GY	电源	
2	OG/WH	接地	

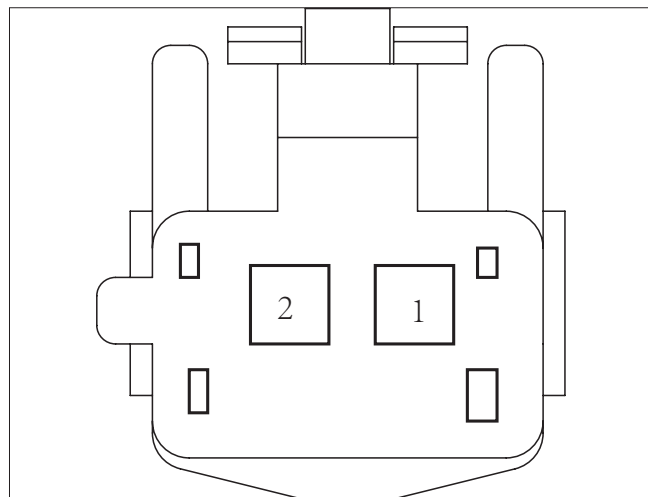

EB83 2sec SBR SNESOR
CONN 2 F 1.5 SICMA BLK

Pin No	Color	Functions	Re- marks
1	D-BU/YE	电源	
2	BK	接地	

51

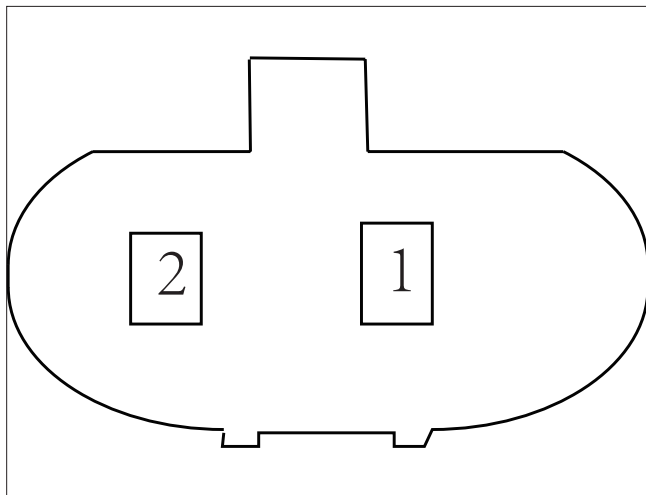

EB81_A 灭火器传感器
CONN 2 F 1.5 SICMA BLK

Pin No	Color	Functions	Re- marks
1	WH/GY	电源	
2	BK/RD	接地	

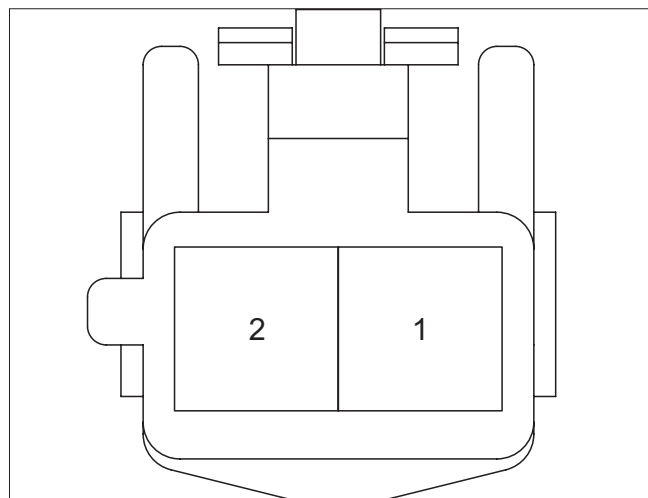

EB84 1sec PASS seat belt SW
E-6171-001 EPC

Pin No	Color	Functions	Re- marks
1	L-GN/RD	电源	
2	WH/L-GN	接地	

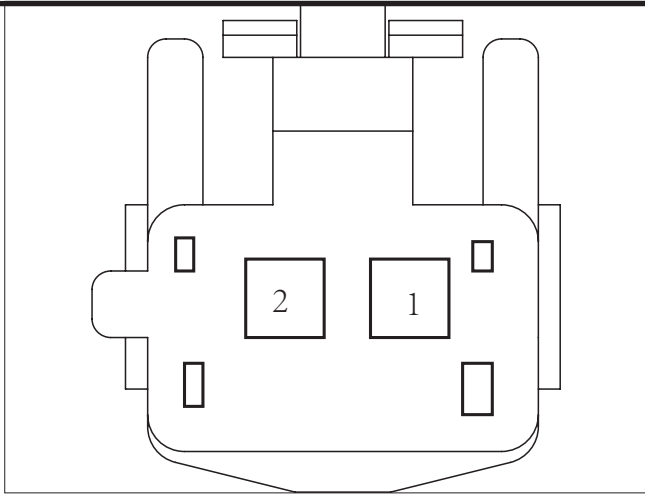

EB85 1st SBR SNESOR
CONN 2 F 1.5 SICMA BLK

Pin No	Color	Functions	Re- marks
1	WH/L-GN	电源	
2	BK	接地	

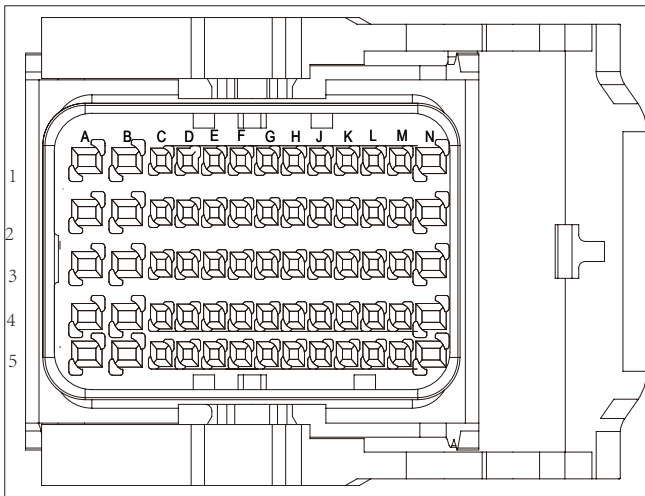

EB1000_1 VCU
CONN 65 F 0.6 BMK 1.5 MCP(left)

Pin No	Color	Functions	Re- marks
A1	-	-	
A2	-	-	
A3	-	-	
A4	-	-	
A5	BK	接地	
B1	BK	接地	

Pin No	Color	Functions	Re- marks
B2	-	-	
B3	-	-	
B4	-	-	
B5	BK	接地	
C1	-	-	
C2	-	-	
C3	BK	接地	
C4	-	-	
C5	-	-	
D1	-	-	
D2	D-BU/BK	接地	
D3	D-GN/GY	Signal-2	
D4	-	-	
D5	YE/BK	CAN1H	
E1	-	-	
E2	-	-	
E3	D-BU/WH	SIG	
E4	D-GN	SIG	
E5	YE/GY	CAN1L	
F1	-	-	
F2	-	-	
F3	-	-	
F4	-	-	
F5	-	-	
G1	-	-	
G2	-	-	
G3	-	-	
G4	-	-	
G5	D-BU/ L-GN	CAN_L	
H1	-	-	
H2	-	-	
H3	-	-	
H4	-	-	
H5	D-BU/YE	CAN_H	

Pin No	Color	Functions	Re- marks
J1	-	-	
J2	-	-	
J3	-	-	
J4	-	-	
J5	-	-	
K1	-	-	
K2	RD/WH	电源	
K3	-	-	
K4	-	-	
K5	-	-	
L1	-	-	
L2	YE	电源	
L3	-	-	
L4	-	-	
L5	-	-	
M1	RD	O_V_VACPRS	
M2	BK/D-GN	O_S_MR	
M3	-	-	
M4	-	-	
M5	RD/GY		
N1	-	-	
N2	BN/VT	电源	
N3	BN/VT	电源	
N4	BK	接地	
N5	RD/GY	电源	

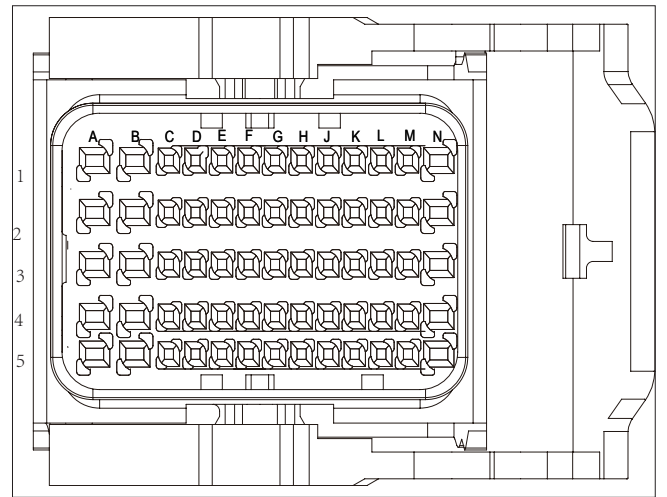

EB1000_2 VCU
ASM CONN 65 F 0.64 MQS 1.5 MX150

Pin No	Color	Functions	Re- marks
A1	-	-	
A2	VT/WH	Charging indicator B-	
A3	-	-	
A4	-	-	
A5	-	-	
B1	-	-	
B2	YE/WH	Charging indicator G	
B3	-	-	
B4	-	-	
B5	-	-	
C1	-	-	
C2	-	-	
C3	WH	O_S_FAN1	
C4	WH/D-BU	O_S_VPRLY	
C5	-	-	
D1	L-GN/BK	Charging indicator R	
D2	-	-	
D3	D-GN/ WH	O_T_WP	
D4	-	-	
D5	L-BU	O_S_FANH	

Pin No	Color	Functions	Re- marks
E1	YE/BK	O_S_FAN2	
E2	D-BU	O_S_FANL	
E3	RD/YE	O_V_ACCPED1	
E4	-	-	
E5	-	-	
F1	-	-	
F2	-	-	
F3	RD/BN	O_V_ACCPED2	
F4	L-GN/GY	I_A_ACCPED2	
F5	-	-	
G1	-	-	
G2	-	-	
G3	-	-	
G4	YE/L-GN	I_A_ACCPED1	
G5	WH/BK	G_R_ACCPED1	
H1	-	-	
H2	-	-	
H3	-	-	
H4	-	-	
H5	BK/L-BU	G_R_ACCPED2	
J1	-	-	
J2	-	-	
J3	-	-	
J4	-	-	
J5	-	-	
K1	-	-	
K2	-	-	
K3	-	-	
K4	OG/WH	I_A_TEMP	
K5	-	-	
L1	-	-	
L2	-	-	
L3	-	-	
L4	-	-	

Pin No	Color	Functions	Re- marks
L5	-	-	
M1	-	-	
M2	-	-	
M3	-	-	
M4	-	-	
M5	-	-	
N1	-	-	
N2	-	-	
N3	-	-	
N4	-	-	
N5	RD/D-GN	O_V_BrkPP	

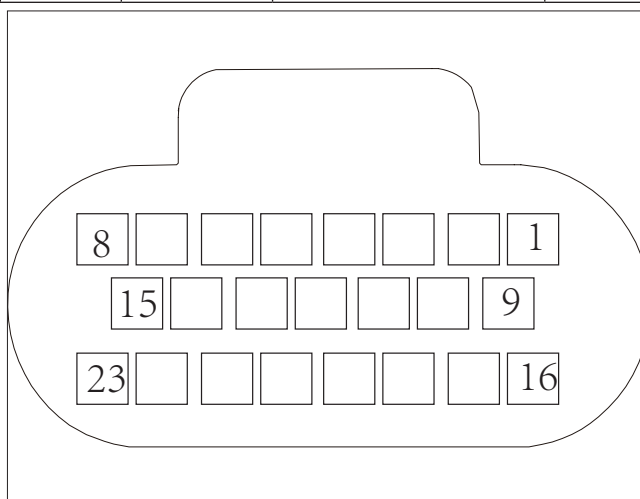

EB1002 PEB

ASM CONN 23 F 064 BLK SLD

Pin No	Color	Functions	Re- marks
1	OG/VT	M -	
2	OG	M -	
3	-	-	
4	-	-	
5	-	-	
6	RD	CAN0_H	
7	-	-	
8	-	-	
9	BN	M +	
10	D-BU	M +	

Pin No	Color	Functions	Re- marks
11	BK	接地	
12	YE	电源	
13	L-GN	IN1_EPARK_ POSITION	
14	BK	CAN0_L	
15	GY/WH	CAN1_L	
16	RD/WH	电源	
17	RD/WH	电源	
18	BK	接地	
19	WH	接地	
20	RD	VDD5_T1	
21	RD/BN	IN2_EPARK_ POSITION	
22	BARE	屏蔽线	
23	D-BU	CAN1_H	

Pin No	Color	Functions	Re- marks
7	BN	M +	
8	D-BU	M +	

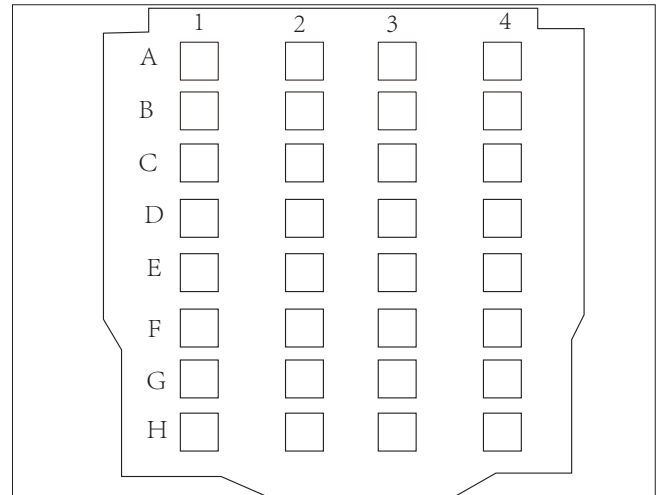

EB1004 CDU
ASM CONN 32 F 0.6 1.5 SLD

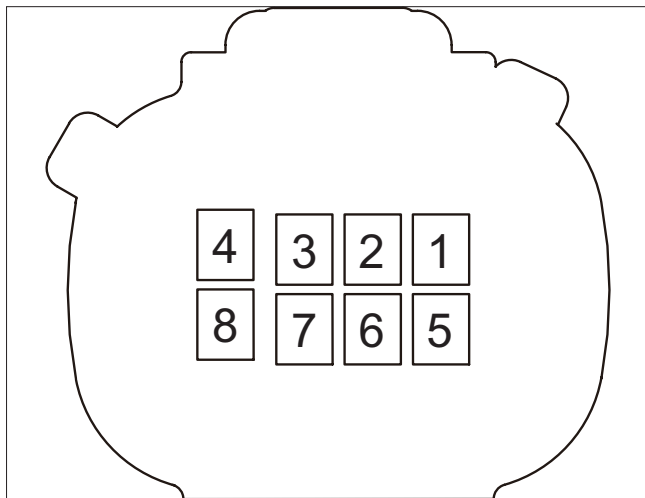

EB1003 EPP
ASM CONN 8 F 1.5 MX150 SLD

Pin No	Color	Functions	Re- marks
1	WH	接地	
2	L-GN	SIG1	
3	RD/BN	SIG2	
4	RD	SIG_PWR	
5	OG/VT	M -	
6	OG	M -	

Pin No	Color	Functions	Re- marks
A1	-	-	
A2	-	-	
A3	-	-	
A4	D-BU/YE	CAN_H	
B1	-	-	
B2	-	-	
B3	-	-	
B4	D-BU/ L-GN	CAN_L	
C1	-	-	
C2	-	-	
C3	-	-	
C4	-	-	
D1	-	-	
D2	-	-	
D3	YE		
D4	-	-	
E1	WH	positive relay +	

Pin No	Color	Functions	Re- marks
E2	-	-	
E3	WH/RD	negative relay+	
E4	-	-	
F1	BK	接地	
F2	-	-	
F3	BK	接地	
F4	-	-	
G1	-	-	
G2	-	-	
G3	-	-	
G4	BK	接地	
H1	RD/GY	电源	
H2	-	-	
H3	-	-	
H4	-	-	

Pin No	Color	Functions	Re- marks
6	WH	CP	
7	YE/RD	Tem L1+	
8	YE/GY	Tem L-	
9	WH/GY	Tem N+	
10	WH/BK	Tem N-	
11	YE/BK	TemL2 +	
12	YE/BN	TemL3 +	

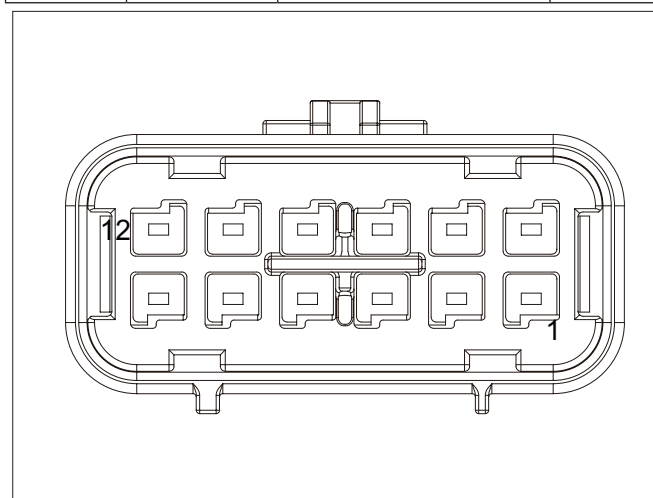
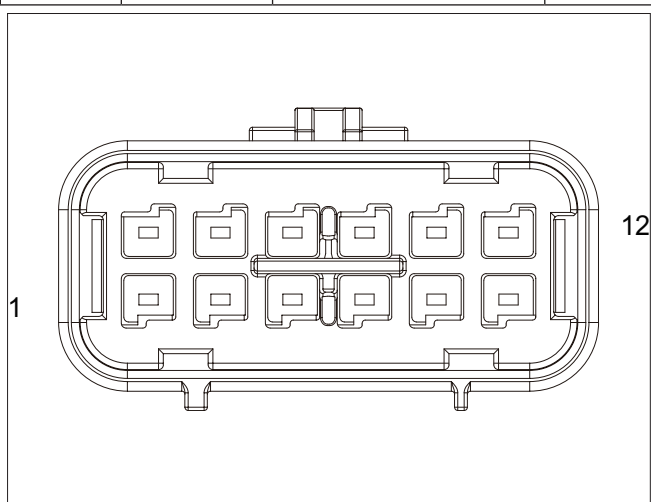

EB1005 EMS_K
CONN 12 F 1.2 MCON-CB BLK SLD

Pin No	Color	Functions	Re- marks
1	OG/YE	LOCKING	
2	OG/BK	UNLOCKING	
3	BK	接地	
4	L-GN/BN	LOCKING SIG	
5	YE	CC	

EB1006 快速充电
CONN 12 M 1.2 BLK SLD

Pin No	Color	Functions	Re- marks
1	PK	12V+	
2	BK	12V-	
3	OG/BN	Tem DC++	
4	OG/L-GN	Tem DC+-	
5	YE/VT	Tem DC-+	
6	OG/L-GN	Tem DC--	
7	BN/L-BU	CAN_H	
8	BN/VT	CAN_L	
9	BARE	屏蔽线	
10	YE/WH	CC2	
11	-	-	
12	-	-	

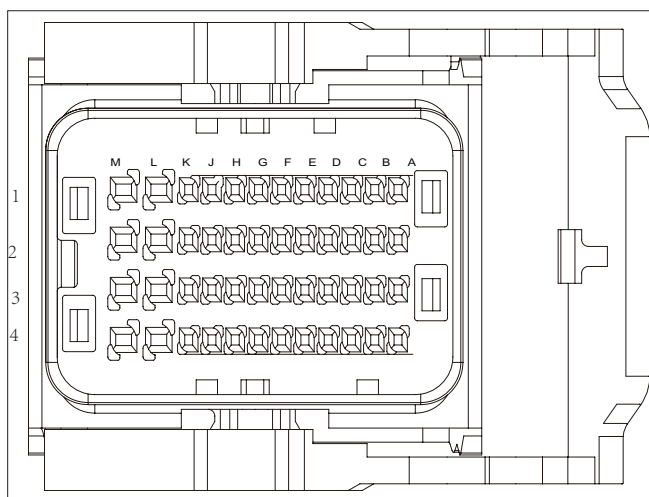

EB1007 EVCC
ASM CONN 48 F 0.6 1.5 SLD

Pin No	Color	Functions	Re- marks
A1	-	-	
A2	-	-	
A3	BARE	屏蔽线	
A4	WH	CP	
B1	-	-	
B2	-	-	
B3	L-GN/YE	CAN_L	
B4	L-GN/BK	CAN_H	
C1	-	-	
C2	YE/VT	Tem DC+	
C3	BN/L-BU	Tem DC--	
C4	-	-	
D1	-	-	
D2	OG/BN	Tem DC++	
D3	WH/D-BU	Tem DC+-	
D4	-	-	
E1	-	-	
E2	-	-	
E3	-	-	
E4	-	-	
F1	-	-	
F2	L-GN/BN	GUN LOCK_DECT	

Pin No	Color	Functions	Re- marks
F3	-	-	
F4	-	-	
G1	-	-	
G2	YE	PP	
G3	-	-	
G4	-	-	
H1	-	-	
H2	-	-	
H3	BN/VT	CAN_L	
H4	BN/L-BU	CAN_H	
J1	-	-	
J2	-	-	
J3	D-BU/ L-GN	CAN_L	
J4	D-BU/YE	CAN_H	
K1	-	-	
K2	OG/BK	GUN LOCK-	
K3	WH/BK	BMS charging wakeup	
K4	-	-	
L1	-	-	
L2	OG/YE	GUN LOCK+	
L3	YE/WH	电源	
L4	BK	接地	
M1	-	-	
M2	-	-	
M3	-	-	
M4	OG/BN	电源	

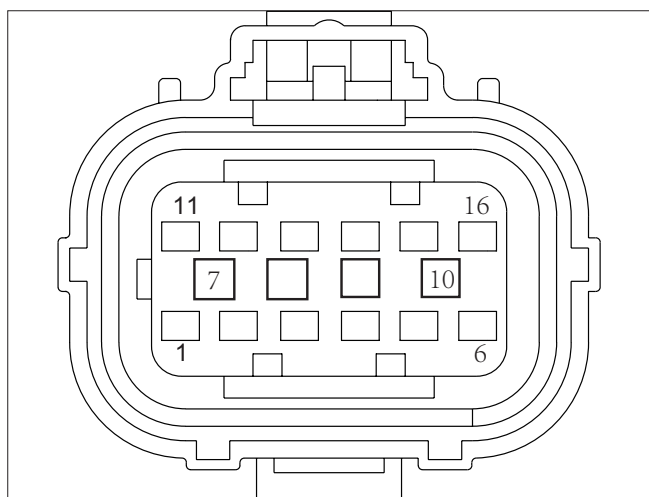

EB1008 CCS
CONN 16 F 1.2 MCON-CB 2.8 MCP SLD

Pin No	Color	Functions	Re- marks
1	WH/D-BU	TemDC+-	
2	OG/BN	TemDC++	
3	BK	接地	
4	YE/VT	TemDC-+	
5	BN/L-BU	TemDC--	
6	OG/YE	LOCK	
7	YE/RD	Tem L1+	
8	YE/BK	Tem L2+	
9	WH/GY	Tem N+	
10	YE/BN	Tem L3+	
11	WH	CP	
12	BARE	屏蔽线	
13	YE	PP	
14	BK	接地	
15	L-GN/BN	CLOCK POSITION FEEDBACK	
16	OG/BK	UNLOCK	

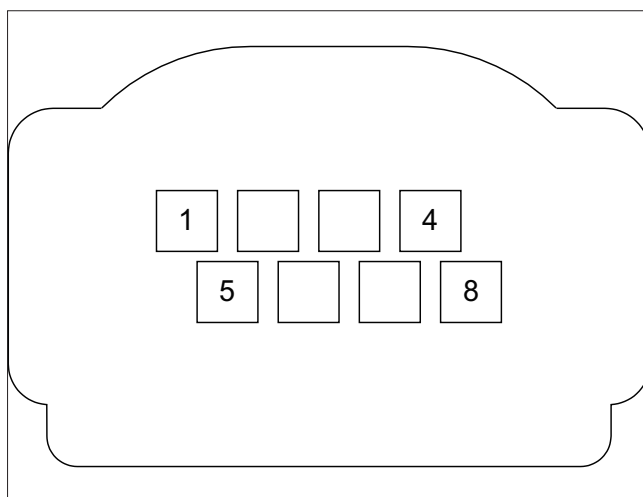

EB1009 AVAS
ASM CONN 8 F 0.64 MQS BLK SLD

Pin No	Color	Functions	Re- marks
1	D-BU/ L-GN	CAN_L	
2	GY/VT	SW2	
3	-	-	
4	BK	接地	
5	D-BU/YE	CAN_H	
6	PK/WH	LED	
7	-	-	
8	YE	IG1	

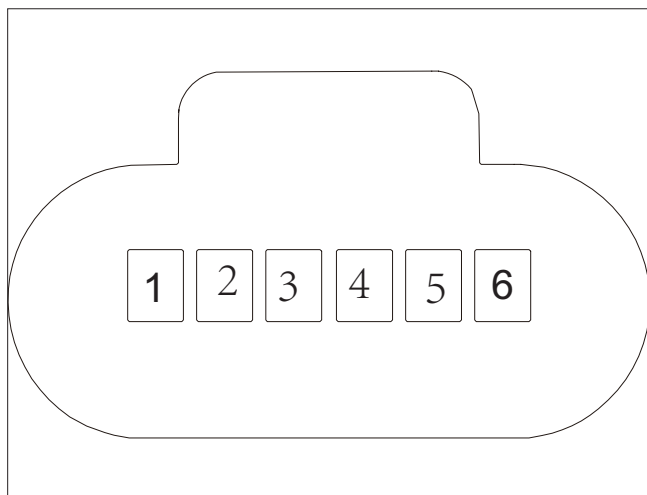

EB1010 踏板位置传感器
1-1564337-1 AMP

Pin No	Color	Functions	Re- marks
1	RD/D-GN	VIN-2	
2	D-BU/BK	接地	
3	D-GN/GY	Signal-2	
4	D-BU	Signal-1	
5	VT	VIN-1	
6	BK	接地	

4.2 Chassis harness

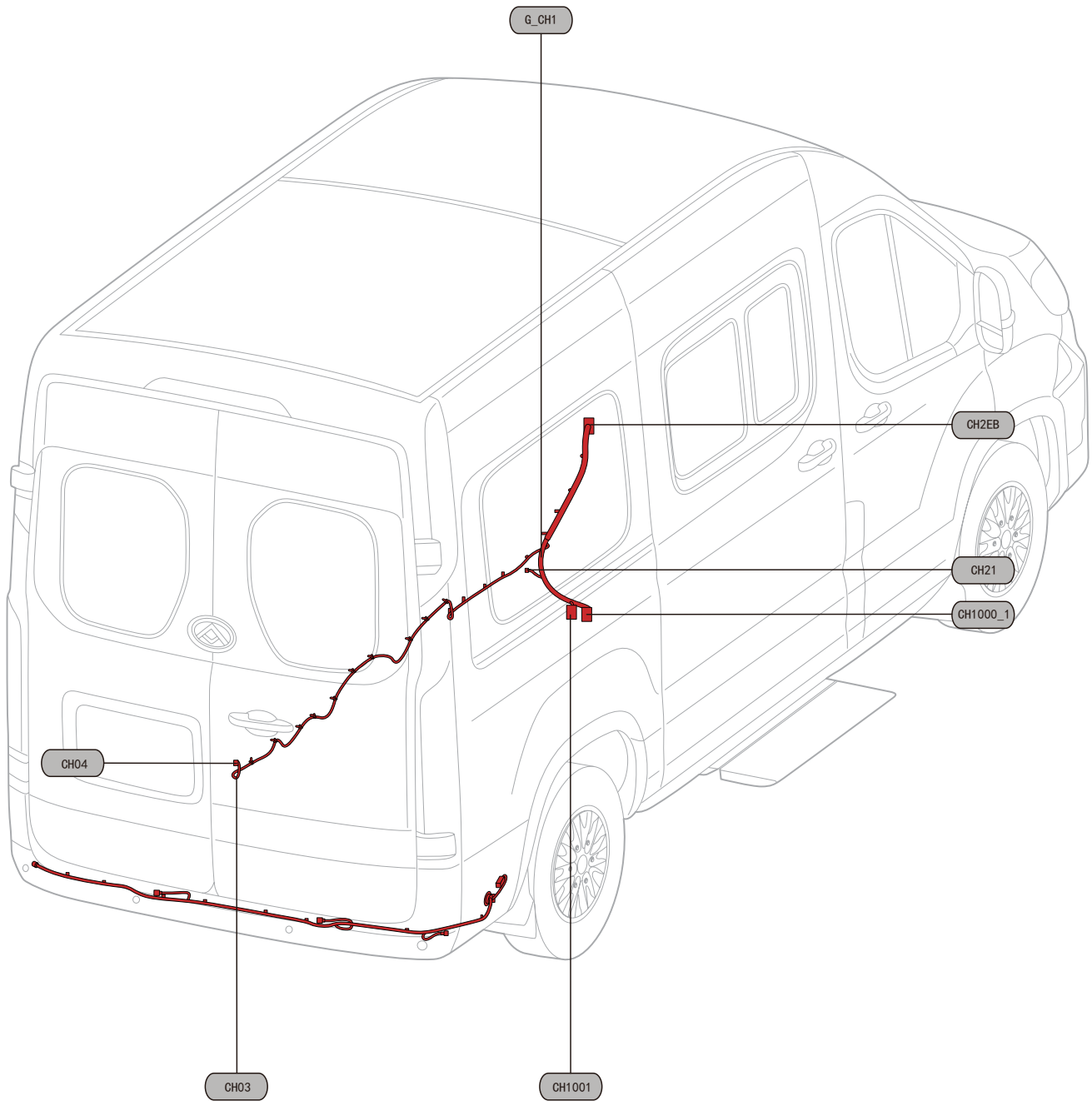

4.2.1 Chassis harness CH

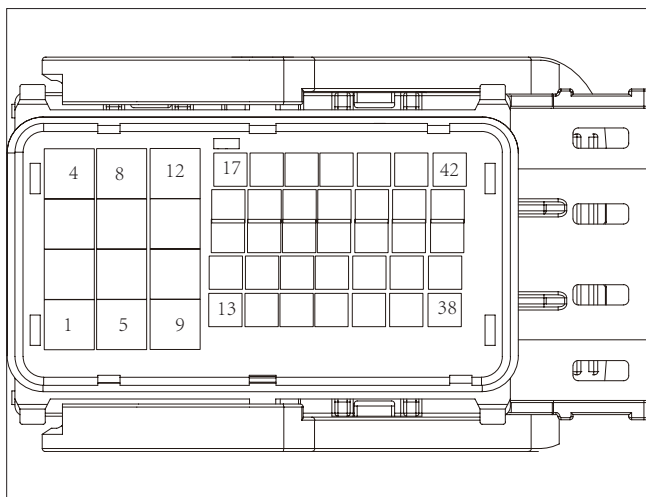

CH2EB_EV 接前舱线束
ASM CONN 42 F 1.6 2.8 JPT SLD

Pin No	Color	Functions	Re- marks
1	OG/BN	Interlock	
2	WH/BK	SIG	
3	WH/RD	PWR	
4	-	-	
5	-	-	
6	RD/D-BU	SIG	
7	RD/BK	PWR	
8	-	-	
9	RD/YE	电源	
10	YE/BK	TemL2 +	
11	YE/BN	TemL3 +	
12	YE	电源	
13	BN/L-BU	CAN_H	
14	BN/VT	CAN_L	
15	BARE	屏蔽线	
16	OG/YE	LOCKING	
17	WH	CP	
18	YE	CC	
19	PK	DC12V+	
20	BK	DC12V-	

Pin No	Color	Functions	Re- marks
21	OG/BN	Tem DC++	
22	OG/BK	UNLOCKING	
23	L-GN/BN	LOCKING SIG	
24	YE/RD	Tem L1+	
25	OG/BK	CAN_H	
26	OG/L-GN	CAN_L	
27	BARE	屏蔽线	
28	WH/D-BU	Crash_PWM	
29	-	-	
30	WH	positive relay +	
31	WH/RD	negative relay+	
32	L-GN/YE	HVIL_IN	
33	OG/L-GN	temp_DC+/-	
34	YE/VT	temp_DC+	
35	BN/L-BU	CAN_H	
36	BN/VT	CAN_L	
37	BARE	屏蔽线	
38	YE	电源	
39	YE/WH	CC2	
40	D-BU/YE	CAN_H	
41	D-BU/ L-GN	CAN_L	
42	BARE	屏蔽线	

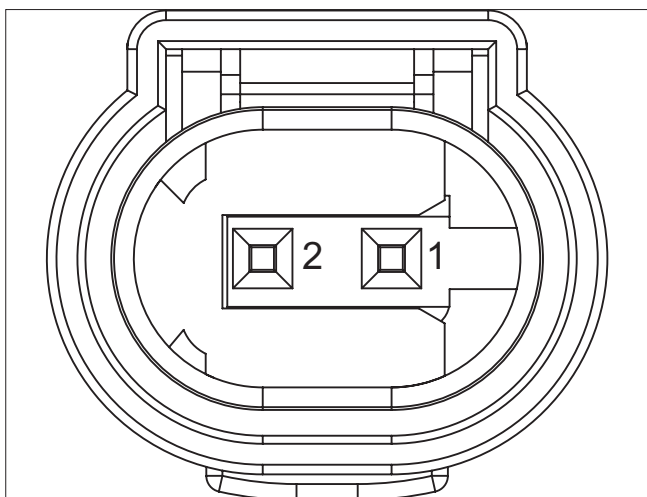

CH03_D 左后轮速传感器
ASM CONN 2 F 0.64 MQS BLK SLD

Pin No	Color	Functions	Re- marks
1	WH/BK	SIG	
2	WH/RD	PWR	

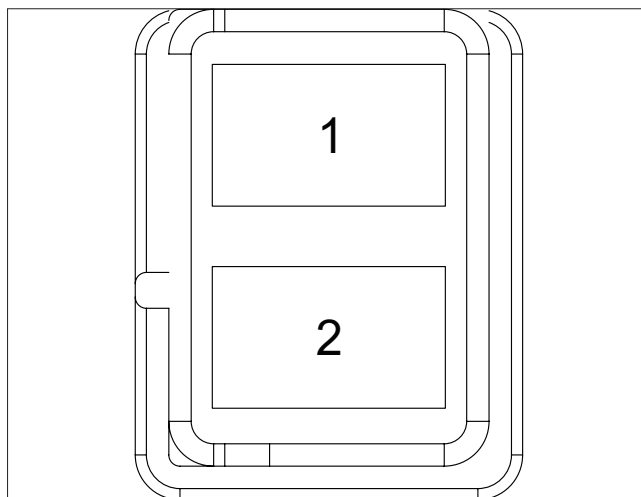

CH12_J LICENSE LAMP LH
CONN 2 F 6.3 NAT

Pin No	Color	Functions	Re- marks
1	BN	PWR	
2	BK	接地	

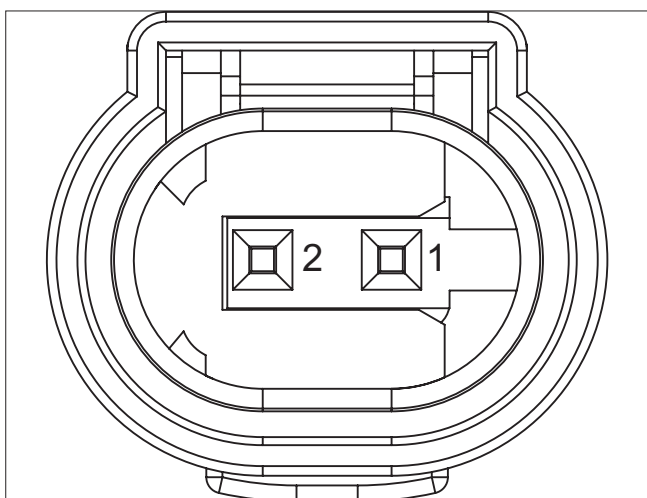

CH04_D 右后轮速传感器
ASM CONN 2 F 0.64 MQS BLK SLD

Pin No	Color	Functions	Re- marks
1	RD/D-BU	SIG	
2	RD/BK	PWR	

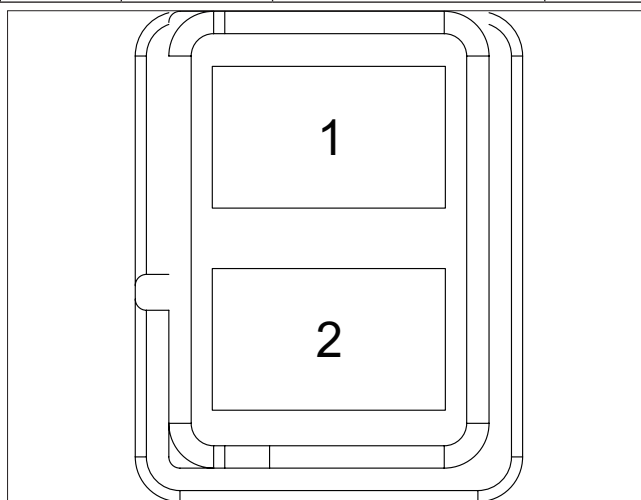

CH13_J LICENSE LAMP RH
1-967644-1 AMP

Pin No	Color	Functions	Re- marks
1	BN	PWR	
2	BK	接地	

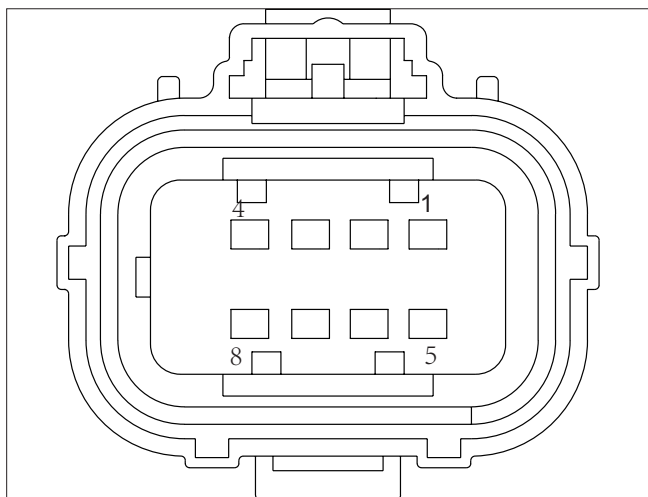

CH14_J 左后组合灯
ASM CONN 8 F 070 BLK SLD

Pin No	Color	Functions	Re- marks
1	WH	STOP	
2	BN	POSITION	
3	BK	接地	
4	WH/RD	TURN	
5	BK	接地	
6	D-GN	REAR FOG	
7	YE	B/UP	
8	-	-	

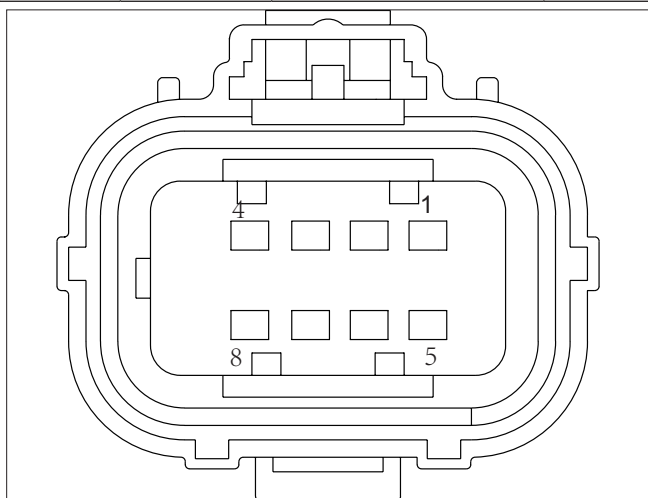

CH15_J 左后组合灯
ASM CONN 8 F 070 BLK SLD

Pin No	Color	Functions	Re- marks
1	WH	STOP	
2	BN	POSITION	
3	BK	接地	
4	RD/BK	TURN	
5	BK	接地	
6	D-GN	REAR FOG	
7	YE	B/UP	
8	-	-	

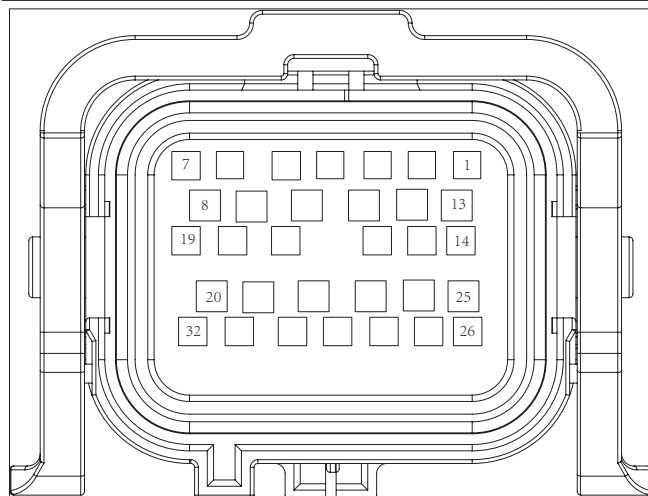

CH1000_1 BMS_CN
CONN 32 F 1.0 1.6

Pin No	Color	Functions	Re- marks
1	RD/YE	电源	
2	L-GN/YE	HVIL_IN	
3	OG/BN	HVIL_OUT	
4	D-BU/YE	CAN1_H	
5	D-BU/ L-GN	CAN1_L	
6	BARE	屏蔽线	
7	OG/YE	LOCKING	
8	L-BU/RD	电源	
9	L-GN/BN	LOCKING_ FEEDBACK	
10	YE/BN	Slow charging temp_L3+	

Pin No	Color	Functions	Re- marks
11	YE/BK	Slow charging temp_L2+	
12	WH	positive relay +	
13	WH/RD	negative relay+	
14	BK	接地	
15	YE/WH	CC2	
16	WH/D-BU	Crash_PWM	
17	OG/BK	CAN_H	
18	OG/L-GN	CAN_L	
19	BK	Fast charging wakeup_A-	
20	BN/VT	CAN2_L	
21	PK	Fast charging wakeup_A+	
22	WH	CP	
23	YE	CC	
24	YE/RD	Slow charging temp_L1+	
25	YE/VT	Fast charging temp_DC+	
26	OG/BN	Fast charging temp_DC++	
27	YE/GY	Slow charging temp_L1/L2/L3-	
28	WH/GY	Slow charging temp_N+	
29	WH/BK	Slow charging temp_N-	
30	OG/L-GN	Fast charging temp_DC+/-	
31	BN/L-BU	CAN2_H	
32	OG/BK	UNLOCKING	

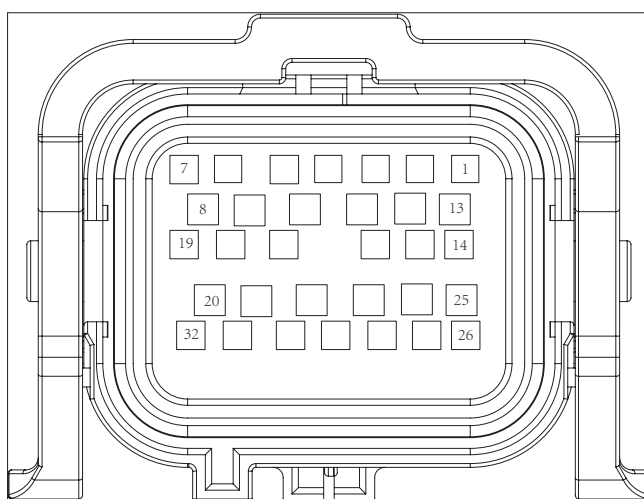

CH1001 BMS_FRA
CONN 32 F 1.0 1.6

Pin No	Color	Functions	Re- marks
1	RD/YE	电源	
2	L-GN/YE	HVIL_IN	
3	OG/BN	HVIL_OUT	
4	D-BU/YE	CAN1_H	
5	D-BU/L-GN	CAN1_L	
6	BARE	屏蔽线	
7	-	-	
8	L-BU/RD	电源	
9	-	-	
10	YE/BN	Slow charging temp_L3+	
11	YE/BK	Slow charging temp_L2+	
12	WH	positive relay +	
13	WH/RD	negative relay+	
14	BK	接地	
15	-	-	
16	WH/D-BU	Crash_PWM	
17	OG/BK	CAN_H	
18	OG/L-GN	CAN_L	
19	-	-	
20	BN/VT	CAN2_L	

Pin No	Color	Functions	Re- marks
21	WH/BK	BMS charging wakeup	
22	-	-	
23	-	-	
24	YE/RD	Slow charging temp_L1+	
25	-	-	
26	-	-	
27	BK	Slow charging temp_L1/L2/L3-	
28	WH/GY	Slow charging temp_N+	
29	WH	Slow charging temp_N-	
30	-	-	
31	BN/L-BU	CAN2_H	
32	-	-	

4.3 Roof harness

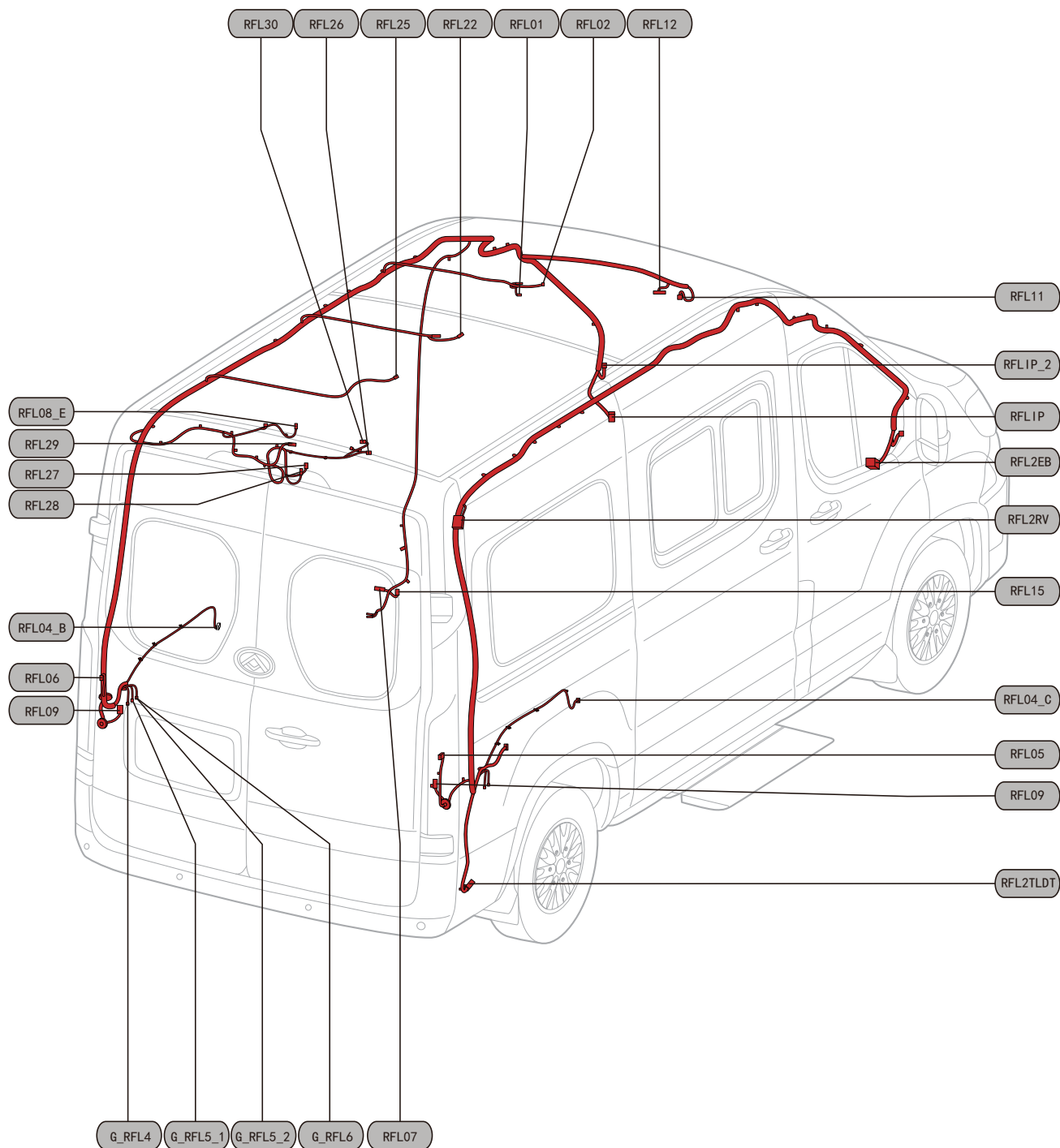

4.3.1 Roof harness connector description

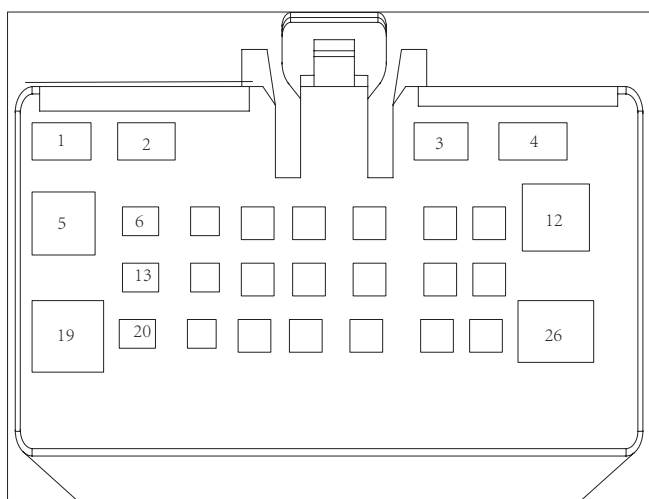

RFR2EB 接前舱线束
ASM CONN 26 F 0.64 1.5 2.8

Pin No	Color	Functions	Re- marks
1	WH	BRAKE_LAMPS_A	
2	BN	POSITION_LAMPS	
3	D-GN	REAR_FOG_LAMPS	
4	L-GN	SNR-PWR	
5	-	-	
6	VT	CAN_H	
7	RD	CUR+	
8	BK	CUR-	
9	GY	AUDIO RF-	
10	VT	AUDIO RF+	
11	L-GN	CDL_TRUNK_UNLOCK MOTOR	
12	-	-	
13	-	-	
14	RD/BK	LCA_LED+	
15	RD/WH	LCA_LED-	
16	BK/RD	SEN-FL	
17	GY	SNR GND	
18	-	-	
19	-	-	
20	-	-	

Pin No	Color	Functions	Re- marks
21	YE	电源	
22	BN/GY	SEN-FLM	
23	D-BU/YE	SEN-FRM	
24	OG/WH	SEN-FR	
25	-	-	
26	-	-	

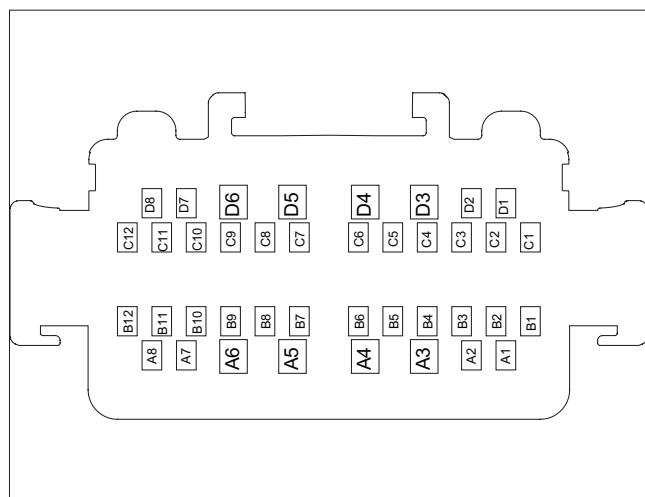

RFR2IP 接仪表线束
CONN 40 M GT 150X32 280X8

Pin No	Color	Functions	Re- marks
A1	RD/BK	TURN	
A2	RD	电源	
A3	RD/WH	电源	
A4	-	-	
A5	-	-	
A6	-	-	
A7	WH/BK	PAS-SW	
A8	VT/WH	Indicator	
B1	VT	AUDIO RF+	
B2	GY	AUDIO RF-	
B3	OG	AUDIO RR+	
B4	VT/D-GN	AUDIO RR-	
B5	RD/D-BU	IG	

Pin No	Color	Functions	Re- marks
B6	GY	LCA_SIG	
B7	GY/WH	LCA_LED	
B8	VT	ACC	
B9	D-BU/WH	CAN_H	
B10	D-BU/ D-GN	CAN_L	
B11	-	-	
B12	-	-	
C1	-	-	
C2	-	-	
C3	-	-	
C4	-	-	
C5	-	-	
C6	-	-	
C7	-	-	
C8	-	-	
C9	RD/D-BU	电源	
C10	WH	DOOR_AJAR_ TRUNK_SW	
C11	-	-	
C12	-	-	
D1	-	-	
D2	-	-	
D3	-	-	
D4	-	-	
D5	-	-	
D6	-	-	
D7	-	-	
D8	-	-	

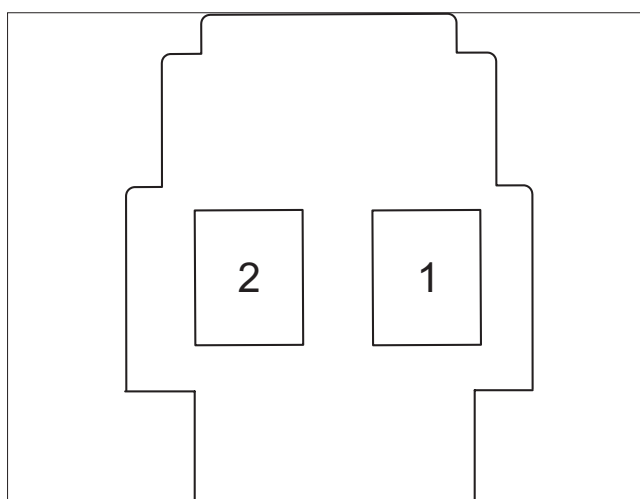

RFR01 高音喇叭
0-0174463-1

Pin No	Color	Functions	Re- marks
1	VT	AUDIO RF+	
2	GY	AUDIO RF-	

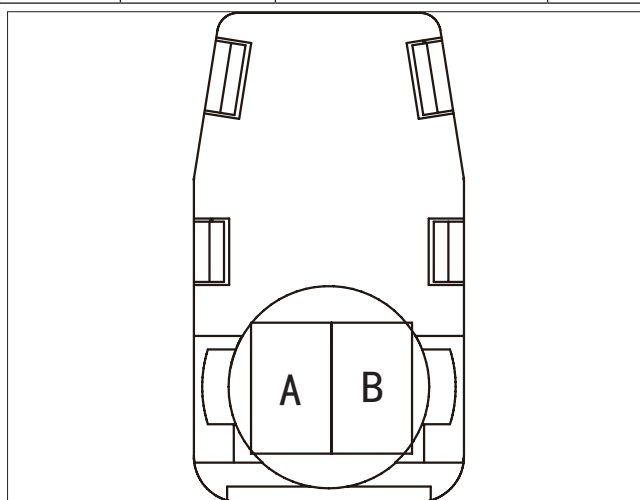

RFR02 副驾帘式气囊
ASM SUBHARNES SRS PIGTAIL L1480

Pin No	Color	Functions	Re- marks
A	RD	电源	
B	BK	接地	

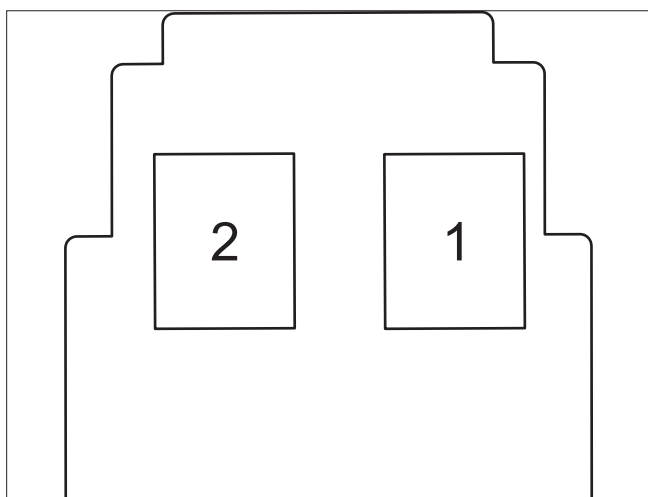

RFR03_E 右前位置灯
CONN 2 F 070 MULTI-LOCK WHT

Pin No	Color	Functions	Re- marks
1	BK	接地	
2	BN	电源	

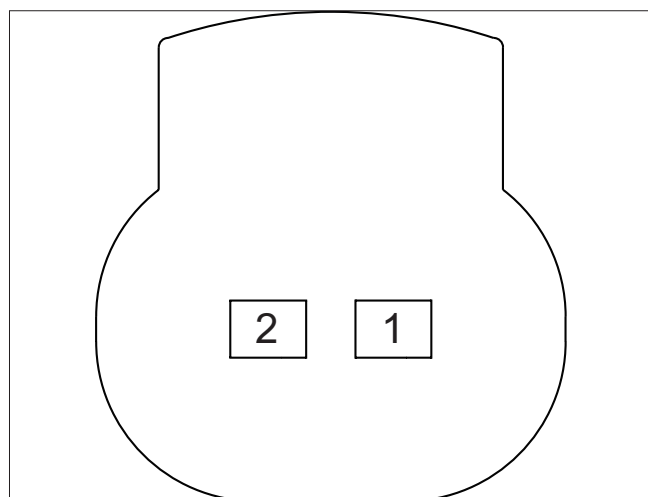

RFR05_A 右后侧标志灯
ASM CONN 2 F 1.2 MCON-CB BLK SLD

Pin No	Color	Functions	Re- marks
1	BK	接地	
2	BN	电源	

51

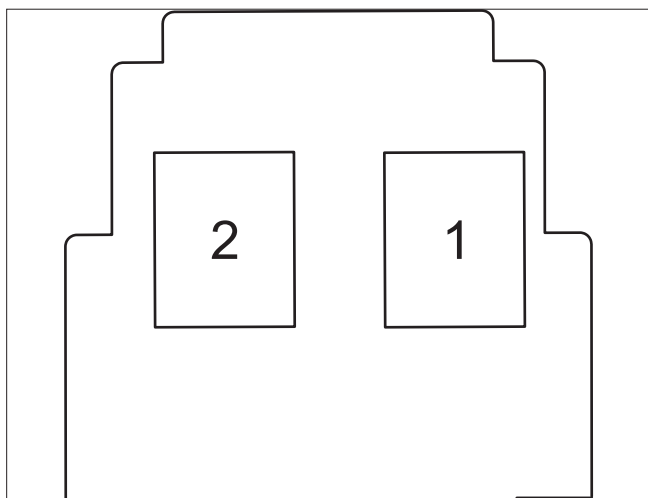

RFR04_C 右后扬声器
CONN 2 F 250 NAT

Pin No	Color	Functions	Re- marks
1	OG	电源	
2	VT/D-GN	接地	

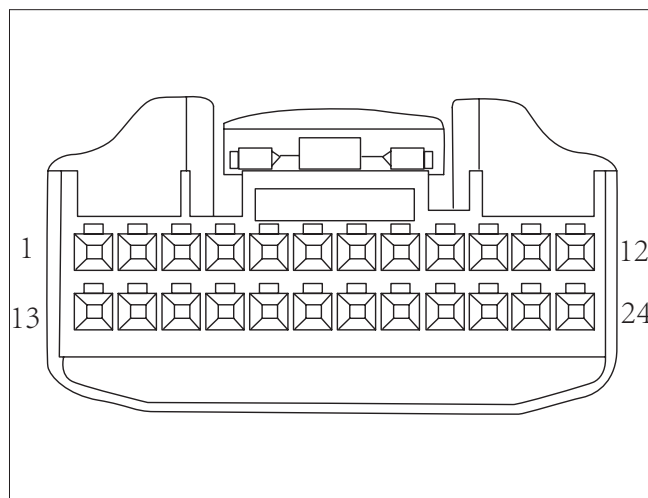

RFR07_A 雷达控制模块
ASM CONN 24 F 025 NAT

Pin No	Color	Functions	Re- marks
1	-	-	
2	-	-	
3	WH	IGN	
4	VT	SNR-RRM	

Pin No	Color	Functions	Re- marks
5	D-BU/WH	CAN_H	
6	D-BU/ D-GN	CAN_L	
7	OG	SNR-RL	
8	VT/D-GN	SNR-RLM	
9	-	-	
10	-	-	
11	L-GN	SNR-PWR	
12	GY	SNR-GND	
13	BK	接地	
14	-	-	
15	BK/WH	SNR-RR	
16	BK	接地	
17	BK/RD	SEN-FL	
18	BN/GY	SEN-FLM	
19	D-BU/YE	SEN-FRM	
20	OG/WH	SEN-FR	
21	-	-	
22	WH/BK	PAS-SW	
23	VT/WH	Indicator	
24	-	-	

Pin No	Color	Functions	Re- marks
1	BN	电源	
2	BK	接地	

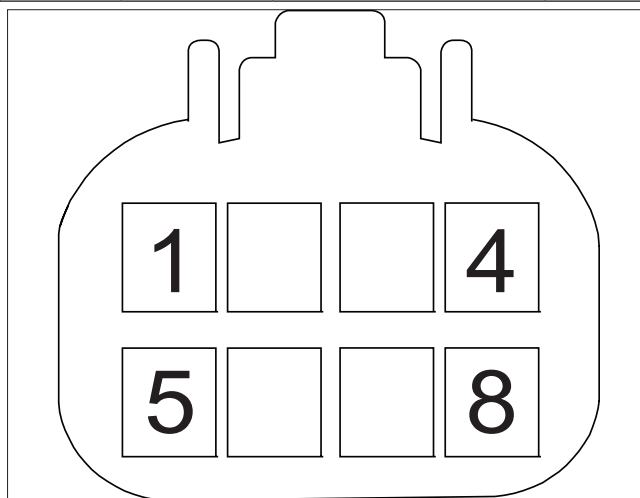

RFR09_A1 右后组合灯
CONN 8 F 070 SWP BLK

Pin No	Color	Functions	Re- marks
1	D-GN	REAR FOG	
2	YE	B/UP	
3	BN	POSITION	
4	WH	STOP	
5	BK	接地	
6	RD/BK	TURN	
7	-	-	
8	BK	接地	

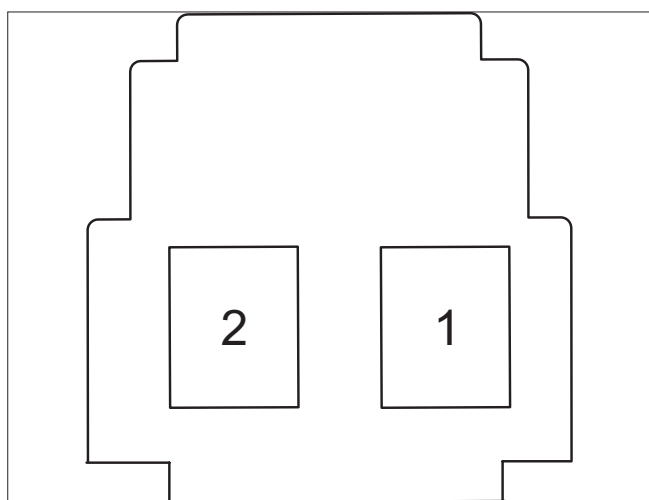

RFR08_E 右后位置灯
Receptable Housing 174056-2

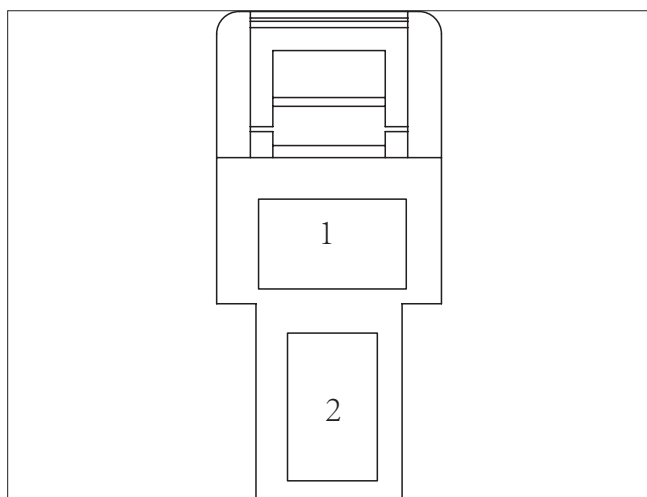

RFR34_A CH CAN RESISTOR
35048543 DELPHI

Pin No	Color	Functions	Re- marks
1	D-BU/WH	CAN_H	
2	D-BU/ D-GN	CAN_L	

4.4 Door harness

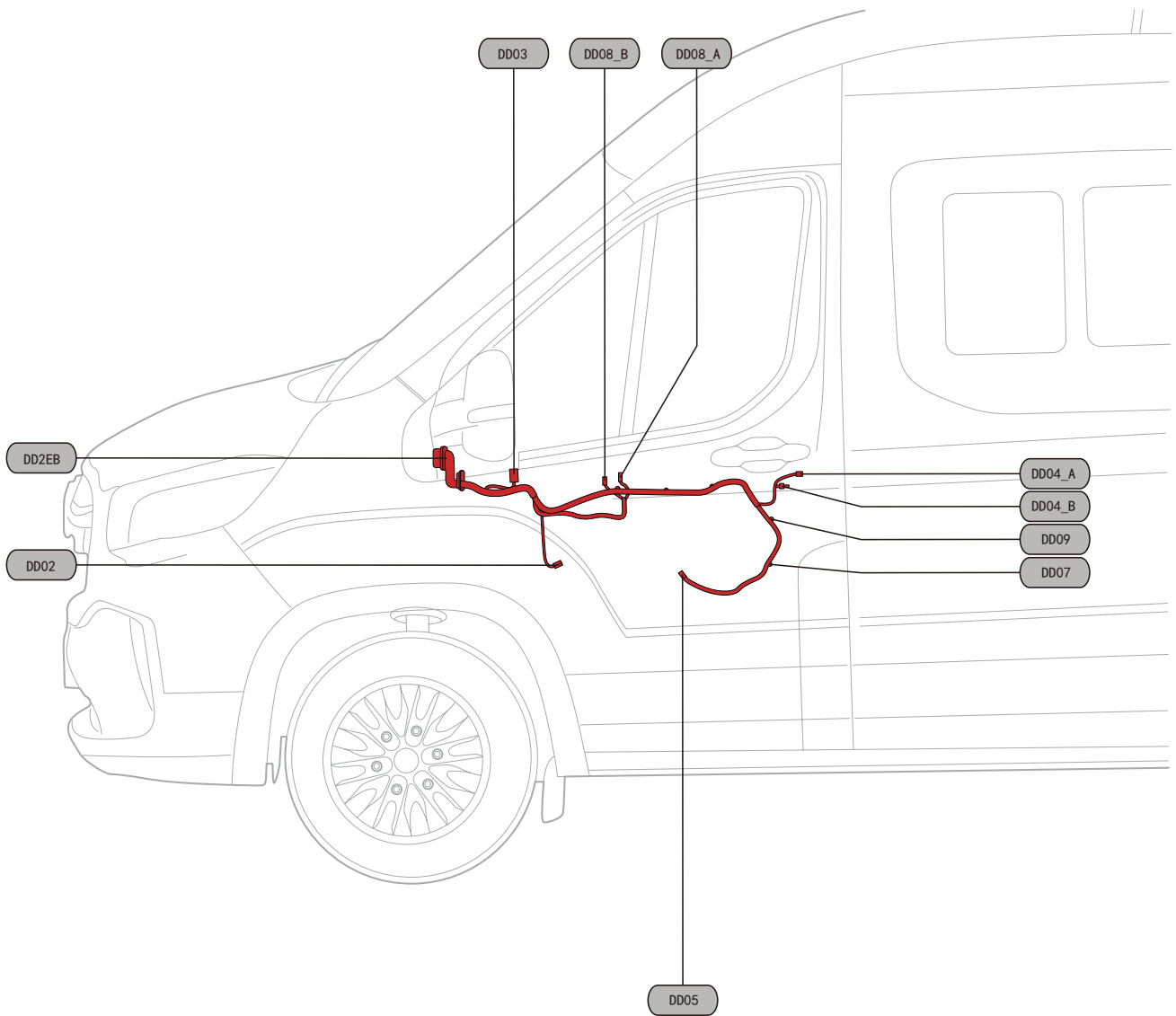

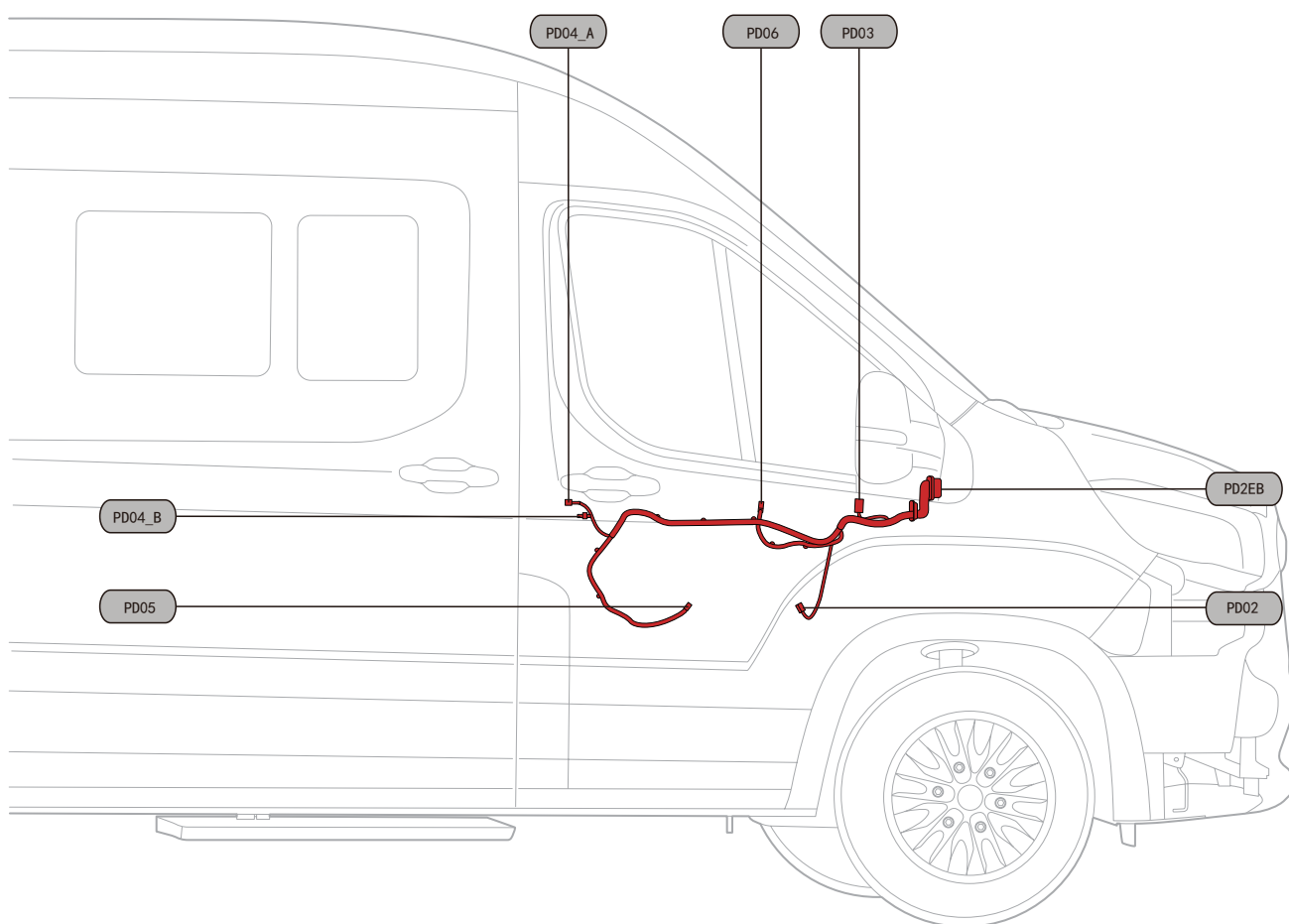

4.4.1 Door harness DD connector description

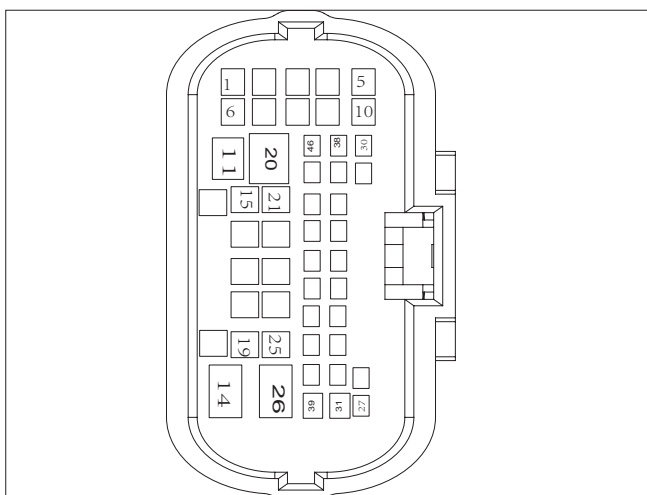

DD2EB 接前舱线束
ASM CONN 46 M 1.5 2.8

Pin No	Color	Functions	Re- marks
1	-	-	
2	-	-	
3	-	-	
4	-	-	
5	-	-	
6	-	-	
7	-	-	
8	-	-	
9	-	-	
10	-	-	
11	BN	LOCK	
12	BN	Indicator	
13	-	-	
14	BK	UNLOCK	
15	-	-	
16	-	-	
17	L-BU	AUDIO LF+	
18	YE	AUDIO LF-	
19	RD/BK	电源	
20	RD/D-BU	电源	

Pin No	Color	Functions	Re- marks
21	-	-	
22	-	-	
23	-	-	
24	-	-	
25	BK	接地	
26	BK	接地	
27	VT	ACC 电	
28	WH/BN	电源	
29	PK/L-BU	PASS_WIN_UP	
30	GY	PASS_WIN_DOWN	
31	WH/YE	TURN_LAMPS_L_ REAR	
32	BN	DOOR_AJAR_ DRV_SW	
33	L-BU	CDL_SNIB_LOCK_ FB_SW_Driver	
34	L-BU	CENTER UNLOCK	
35	YE	CENTER LOCK	
36	WH	ILL+	
37	L-GN/BN	XY COMMON	
38	VT	X MTR	
39	L-GN	Y MTR	
40	L-GN/VT	DRV DOOR SW SIG	
41	WH/YE	ANT+	
42	WH/D-BU	ANT-	
43	L-GN/BN	LIN2	
44	-	-	
45	-	-	
46	-	-	

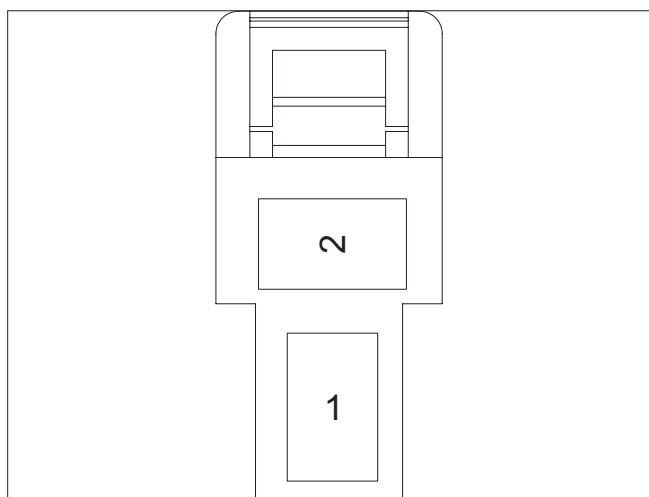

DD02 左前低音喇叭
1-967644-1 AMP

Pin No	Color	Functions	Re- marks
1	L-BU	AUDIO LF+	
2	YE	AUDIO LF-	

Pin No	Color	Functions	Re- marks
6	L-GN	Y MTR	
7	WH/YE	TURN LAMP	
8	BK	接地	

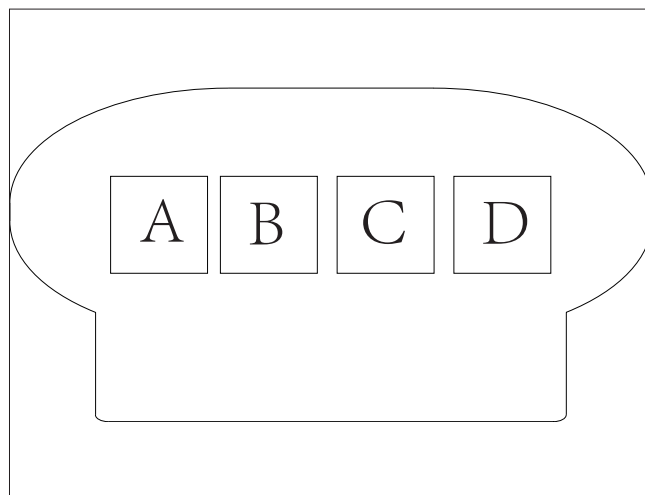

DD04_A 驾驶室门锁
ASM CONN 4 F GT 150 BLK SLD

Pin No	Color	Functions	Re- marks
A	BN	DOOR_AJAR_ DRV_SW	
B	BK	接地	
C	BK	DRIVER UNLOCK	
D	BN	CDL_LOCK_ MOTORS	

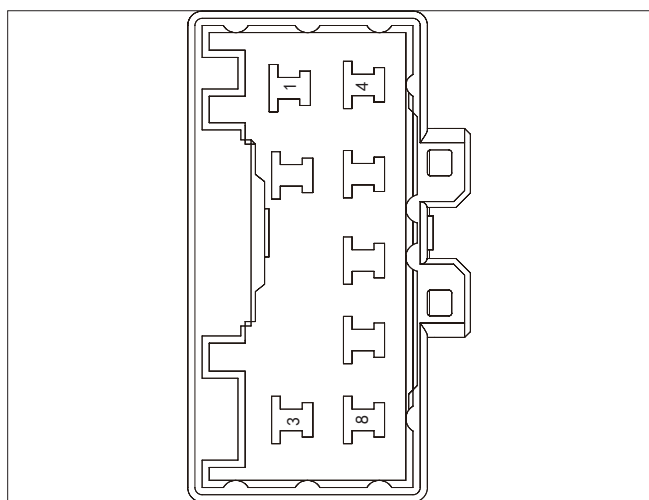

DD03 左电动后视镜
MG610320-5 KET

Pin No	Color	Functions	Re- marks
1	WH/BN	HEATED DEFOG	
2	BK	接地	
3	RD/BK	LCA_LED+	
4	VT	X MTR	
5	L-GN/BN	XY COMMON	

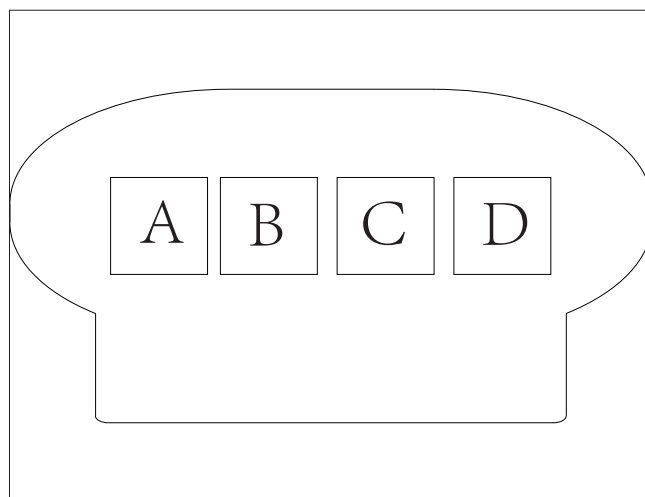

DD04_B 驾驶室门锁

PACKARD KOREA INC

Pin No	Color	Functions	Re- marks
A	L-BU	LOCK SW	
B	BK	接地	
C	-	-	
D	-	-	

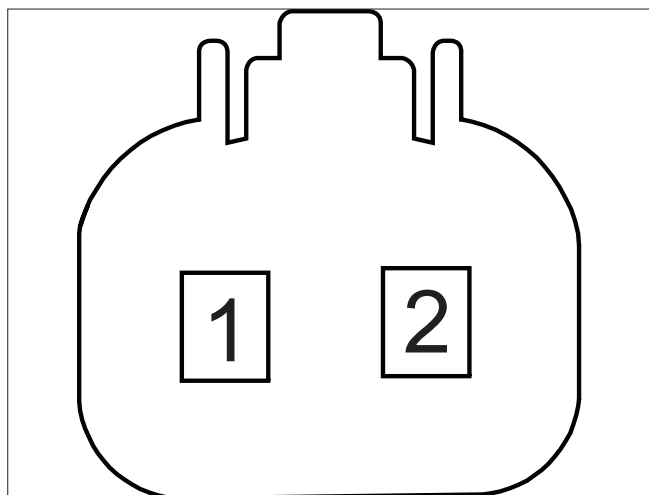

DD05 左前电动车窗电机
MG610320-5 KET

Pin No	Color	Functions	Re- marks
1	D-BU	DRV_WIN_UP	
2	BK/L-GN	DRV_WIN_DOWN	

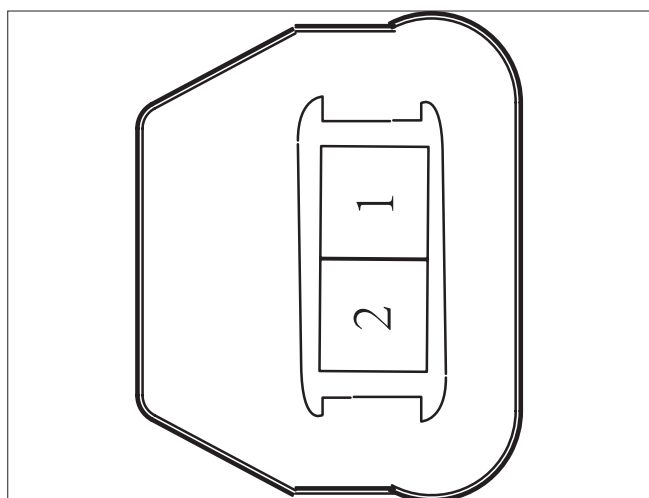

DD07 左前侧标志灯
2-1718643-1 AMP

Pin No	Color	Functions	Re- marks
1	BK	接地	
2	BN	电源	

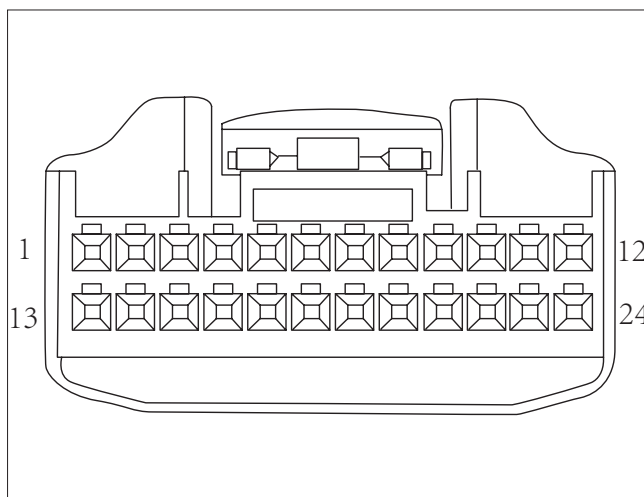

DD08_A 左前电动车窗开关
ASM CONN 24 F 025 NAT

Pin No	Color	Functions	Re- marks
1	-	-	
2	-	-	
3	-	-	
4	-	-	
5	-	-	
6	WH	ILL+	
7	BK	ILL-	
8	-	-	
9	-	-	
10	-	-	
11	-	-	
12	-	-	
13	L-BU	CENTER UNLOCK	
14	-	-	
15	-	-	
16	-	-	
17	-	-	

Pin No	Color	Functions	Re- marks
18	-	-	
19	BK	接地	
20	-	-	
21	GY	PASS_WIN_DOWN	
22	VT	RAP	
23	PK/L-BU	PASS_WIN_UP	
24	YE	CENTER LOCK	

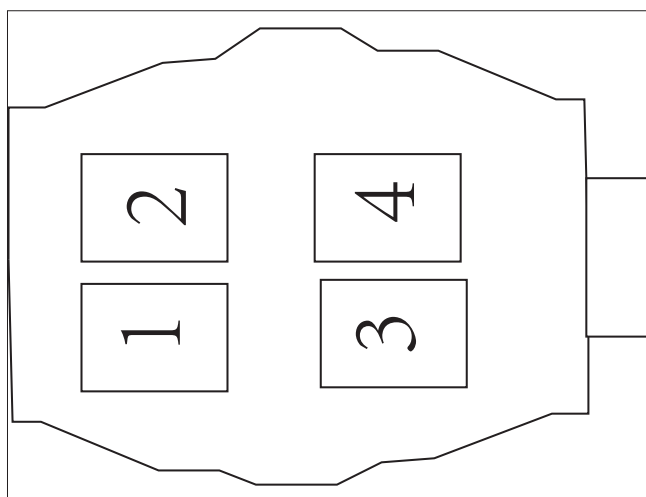

DD09 PEPS ANT
CONN 4 M 090 BLK SLD

Pin No	Color	Functions	Re- marks
1	BK	接地	
2	L-GN/VT	DRV DOOR SW SIG	
3	WH/D-BU	ANT-	
4	WH/YE	ANT+	

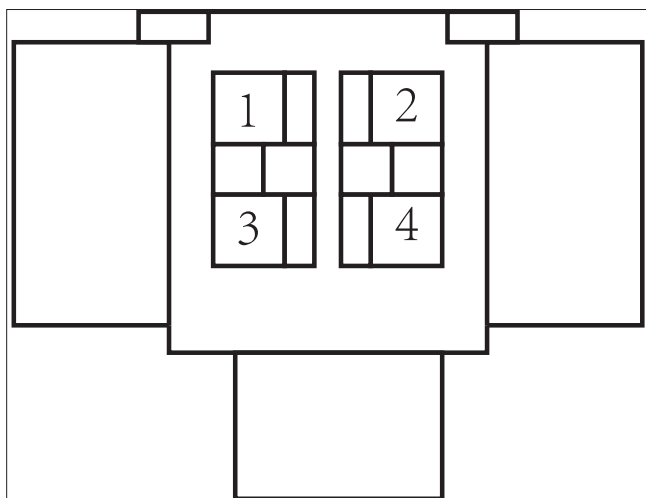

DD08_B 左前电动车窗开关
CONN 4 F 2.8 TIMER BLK JR PWR

Pin No	Color	Functions	Re- marks
1	D-BU	DRV_WIN_UP	
2	BK/L-GN	DRV_WIN_DOWN	
3	BK	接地	
4	RD/D-BU	电源	

4.5 Battery harness

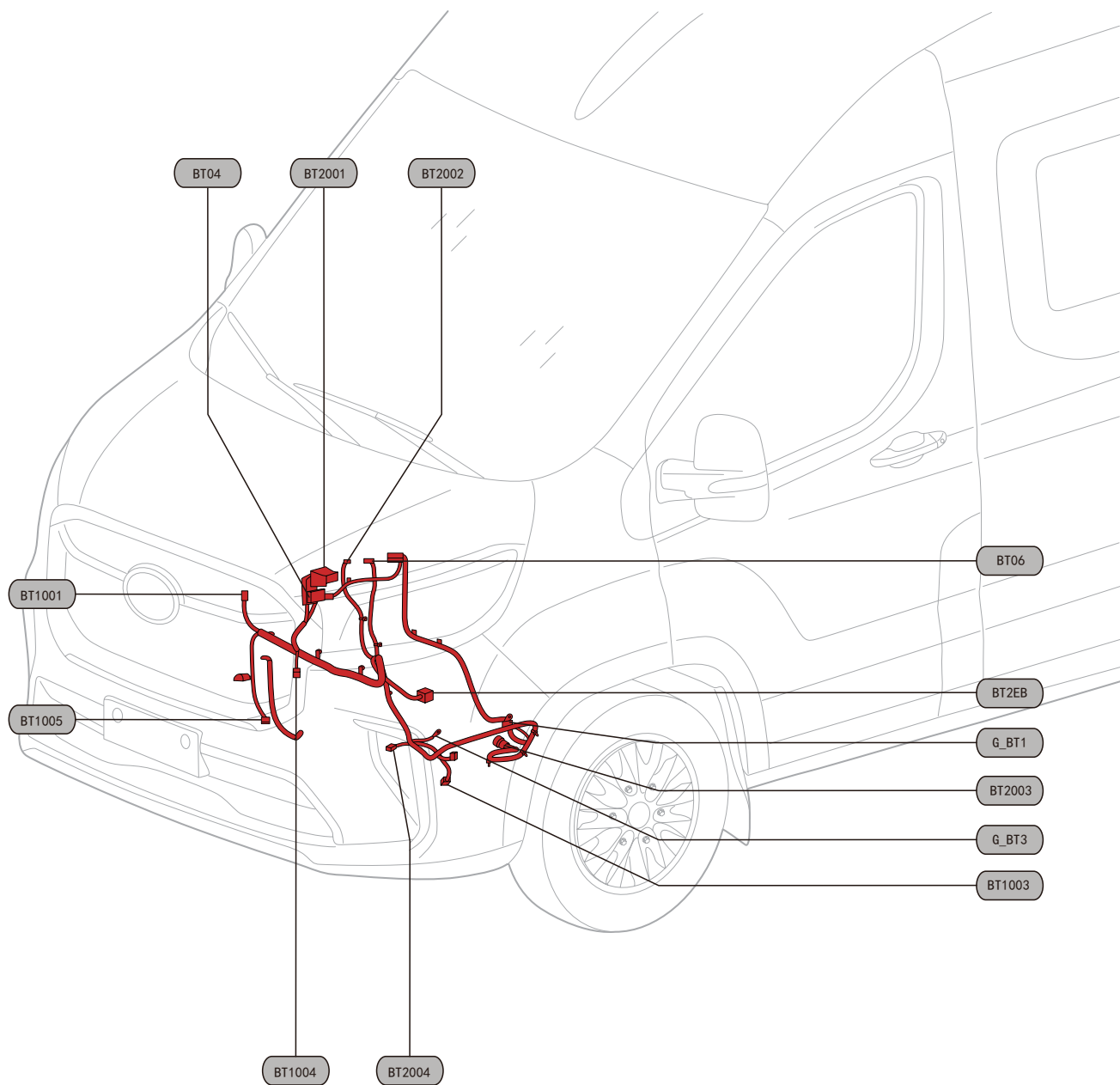

4.5.1 Battery harness connector description

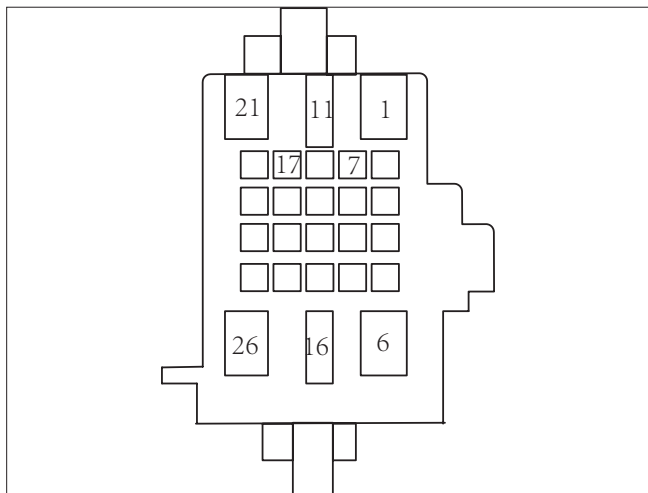

BT2EB 接前舱线束
CONN 26 M BLK

Pin No	Color	Functions	Re- marks
1	RD/VT	电源	
2	L-GN/YE	HVIL_IN	
3	OG/BN	HVIL_OUT	
4	OG/BN	电源	
5	D-GN/GY	LIN	
6	RD/D-GN	PWR	
7	4004A	PWM	
8	OG	电源	
9	OG/WH	I_A_TEMP	
10	D-BU/WH	G_R_TEMP	
11	-	-	
12	D-BU/WH	CAN_H	
13	D-BU/ D-GN	CAN_L	
14	D-BU/WH	CAN_H	
15	D-BU/ D-GN	CAN_L	
16	-	-	
17	L-BU	Sensor supply(+)	
18	WH	Sensor supply(-)	
19	GY/BK	singal(real time)	
20	VT/YE	I/O data signal	

Pin No	Color	Functions	Re- marks
21	-	-	
22	-	-	
23	-	-	
24	-	-	
25	-	-	
26	-	-	

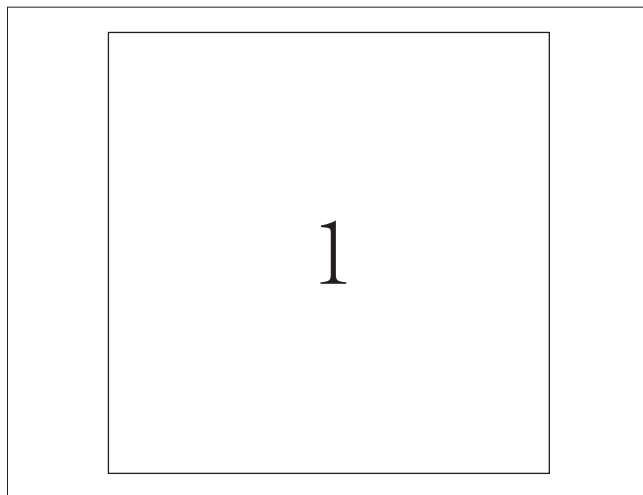

BT04 UEC
ASM CONN 24 F 025 NAT

Pin No	Color	Functions	Re- marks
1	RD	电源	

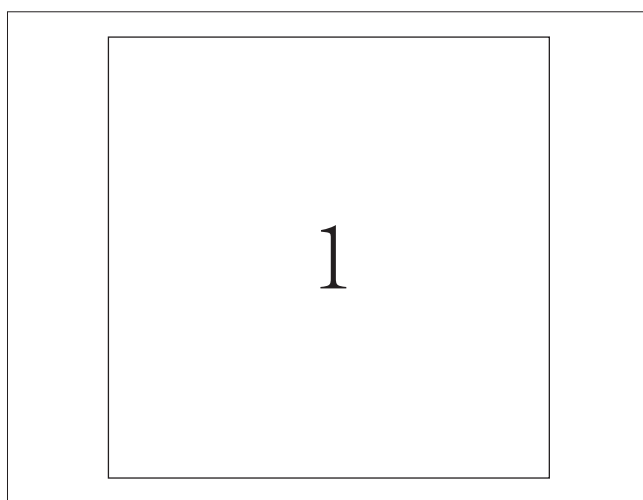

BT1001 CDU
RSD2D2263

Pin No	Color	Functions	Re- marks
1	RD	电源	

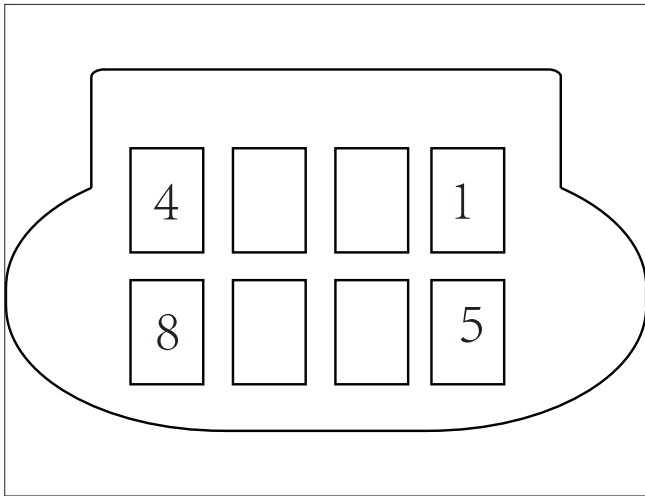

BT1003 空调压缩机
ASM CONN 8 F 1.2 BLK SLD

Pin No	Color	Functions	Re- marks
1	OG/BN	电源	
2	D-GN/GY	LIN	
3	BK	接地	
4	-	-	
5	-	-	
6	L-GN/YE	Interlock	
7	OG/BN	Interlock	
8	-	-	

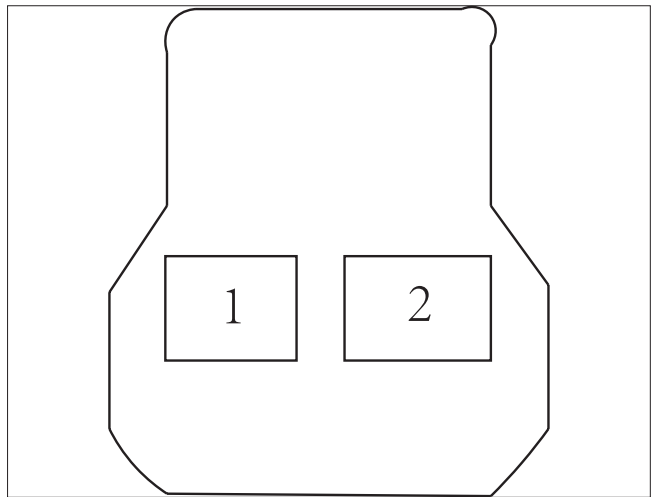

BT1004 冷却液温度传感器
ASM CONN 2 F 1.5 GRA SLD

Pin No	Color	Functions	Re- marks
1	OG/WH	接地	
2	D-BU/WH	电源	

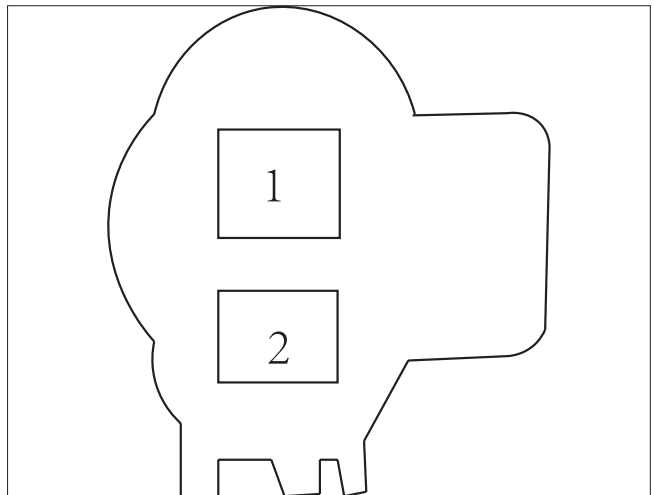

BT1005 真空泵
ASM CONN 2 M 2.8 GRA SLD

Pin No	Color	Functions	Re- marks
1	RD/D-GN	电源	
2	BK	接地	

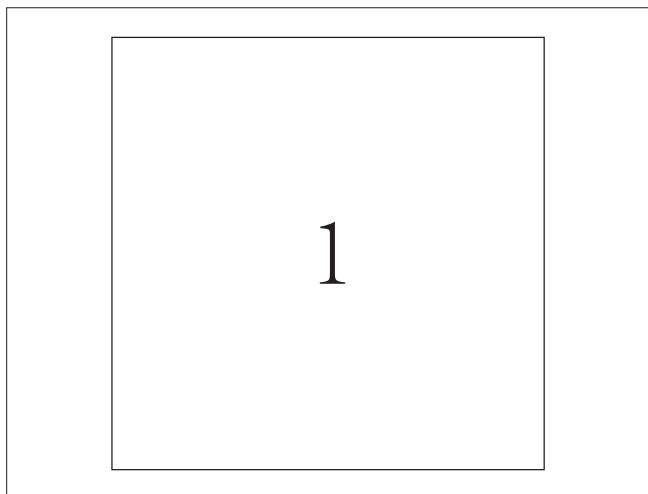

BT2002 UEC
RSD2D1725

Pin No	Color	Functions	Re- marks
1	RD	电源	

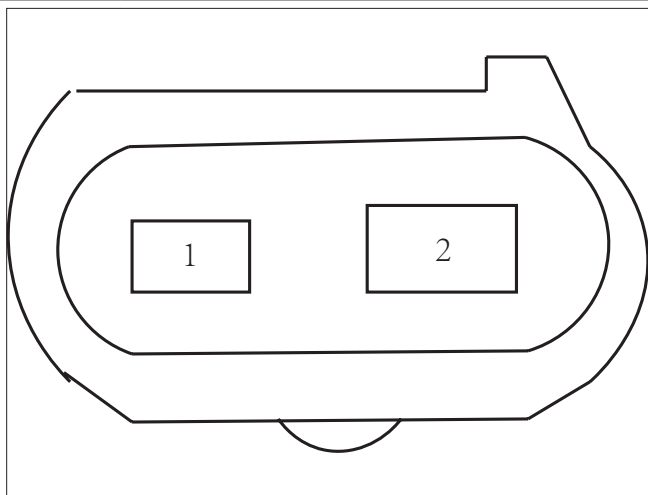

BT2003_1 EPS
ASM CONN 2 F MAK 12 MM BLK SLD

Pin No	Color	Functions	Re- marks
1	RD	电源	
2	BK	接地	

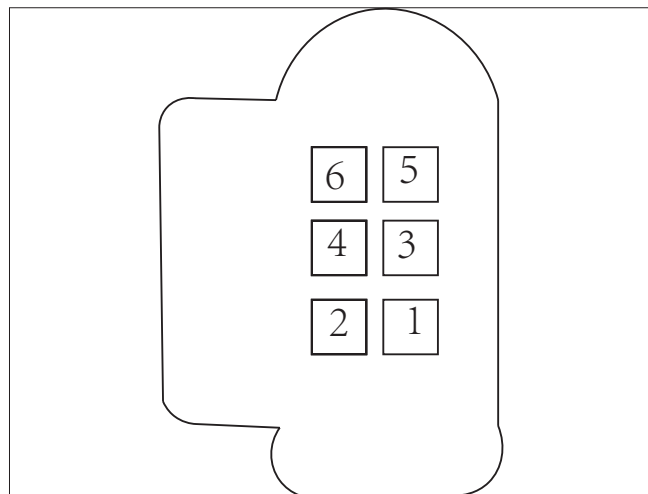

EB2003_2 EPS
ASM CONN 6 F 1.5 BLK

Pin No	Color	Functions	Re- marks
1	OG	电源	
2	-	-	
3	-	-	
4	D-BU/ D-GN	CAN_L	
5	-	-	
6	D-BU/WH	CAN_H	

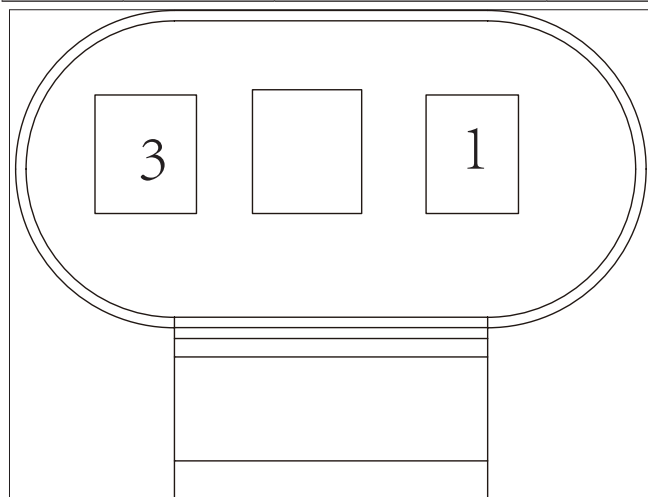

BT2004 冷却液泵
282087-1

Pin No	Color	Functions	Re- marks
1	RD/VT	电源	
2	D-GN/ WH	PWM	
3	BK	接地	

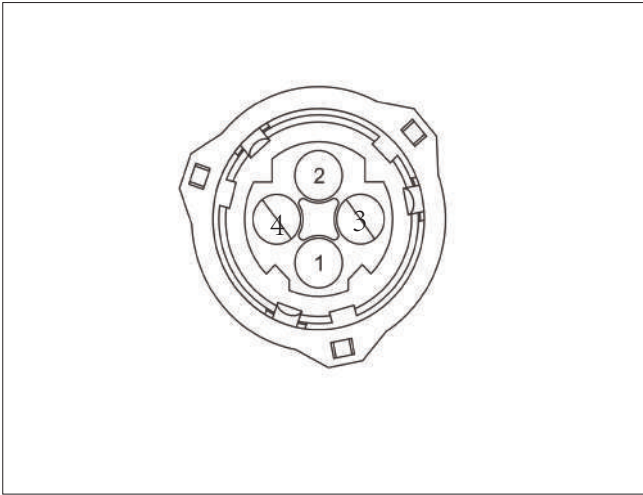

BT3001 速度传感器
1-1813099-1

Pin No	Color	Functions	Re- marks
1	L-BU	Sensor supply(+)	
2	WH	Sensor supply(-)	
3	GY/BK	signal(real time)	
4	VT/YE	I/O data signal	

4.6 Instrument Harness

4.6.1 Instrument Harness 1 - Left rudder

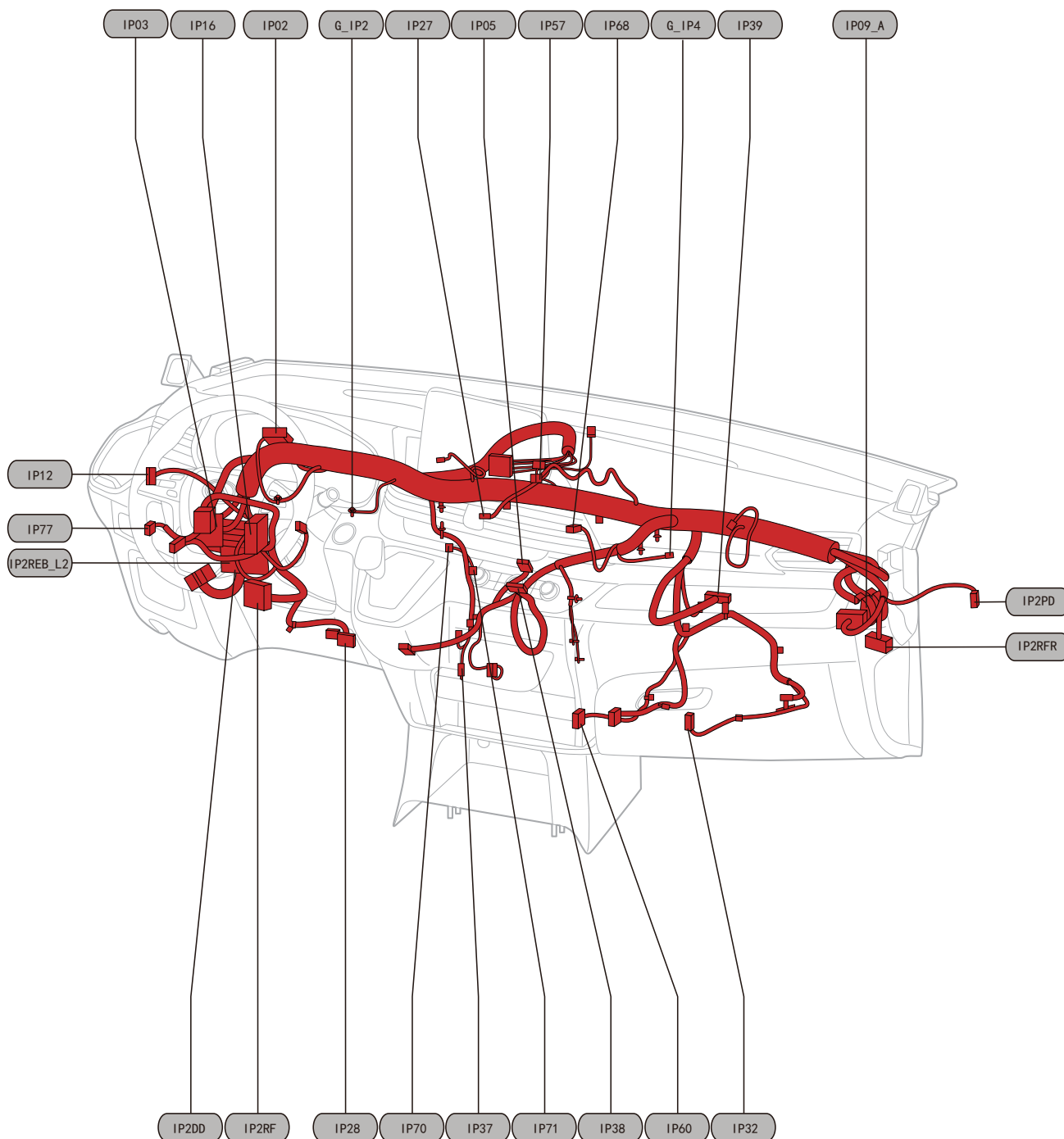

4.6.2 Instrument Harness 2 - Left rudder

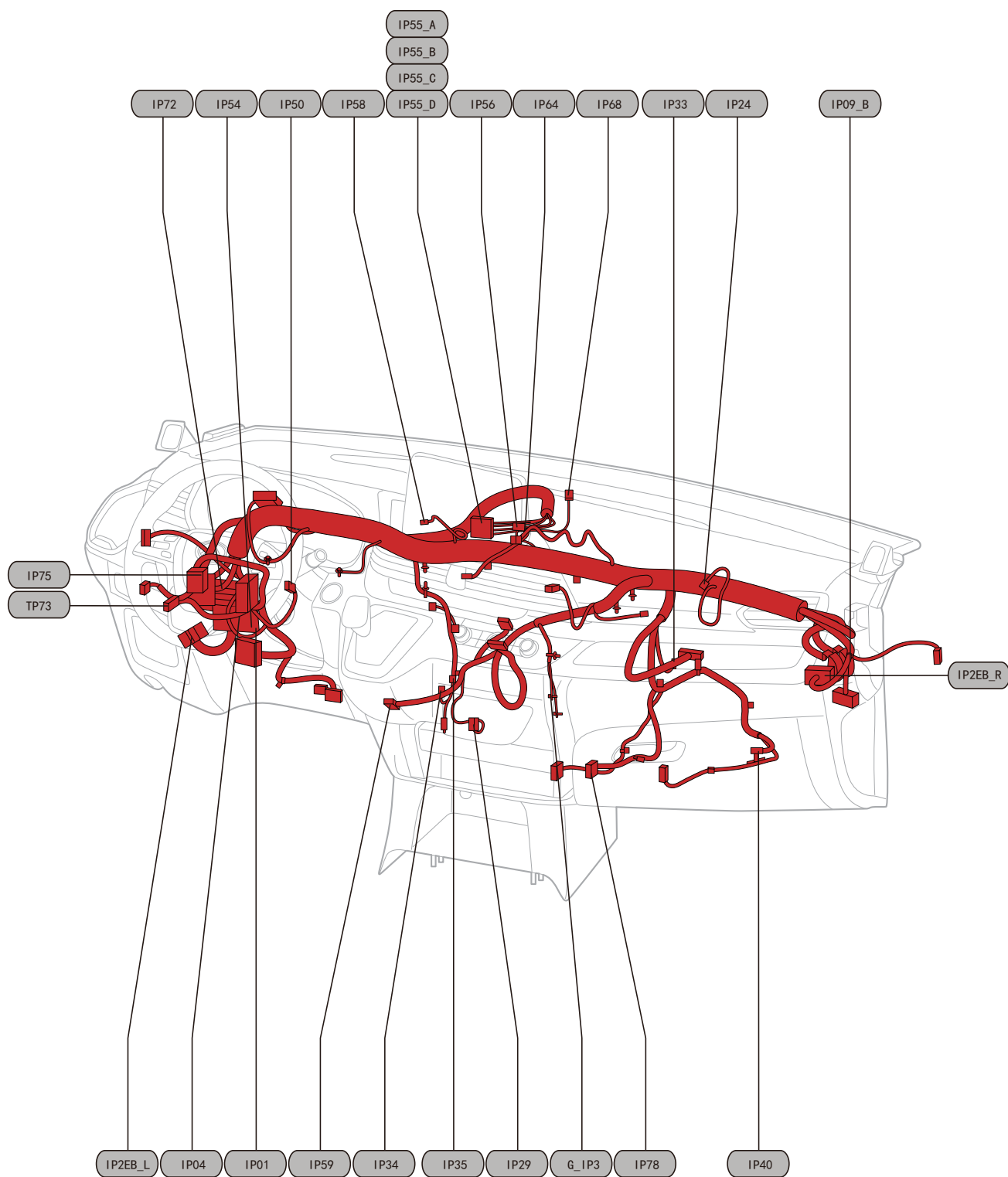

4.6.3 Instrument Harness 1 - Right rudder

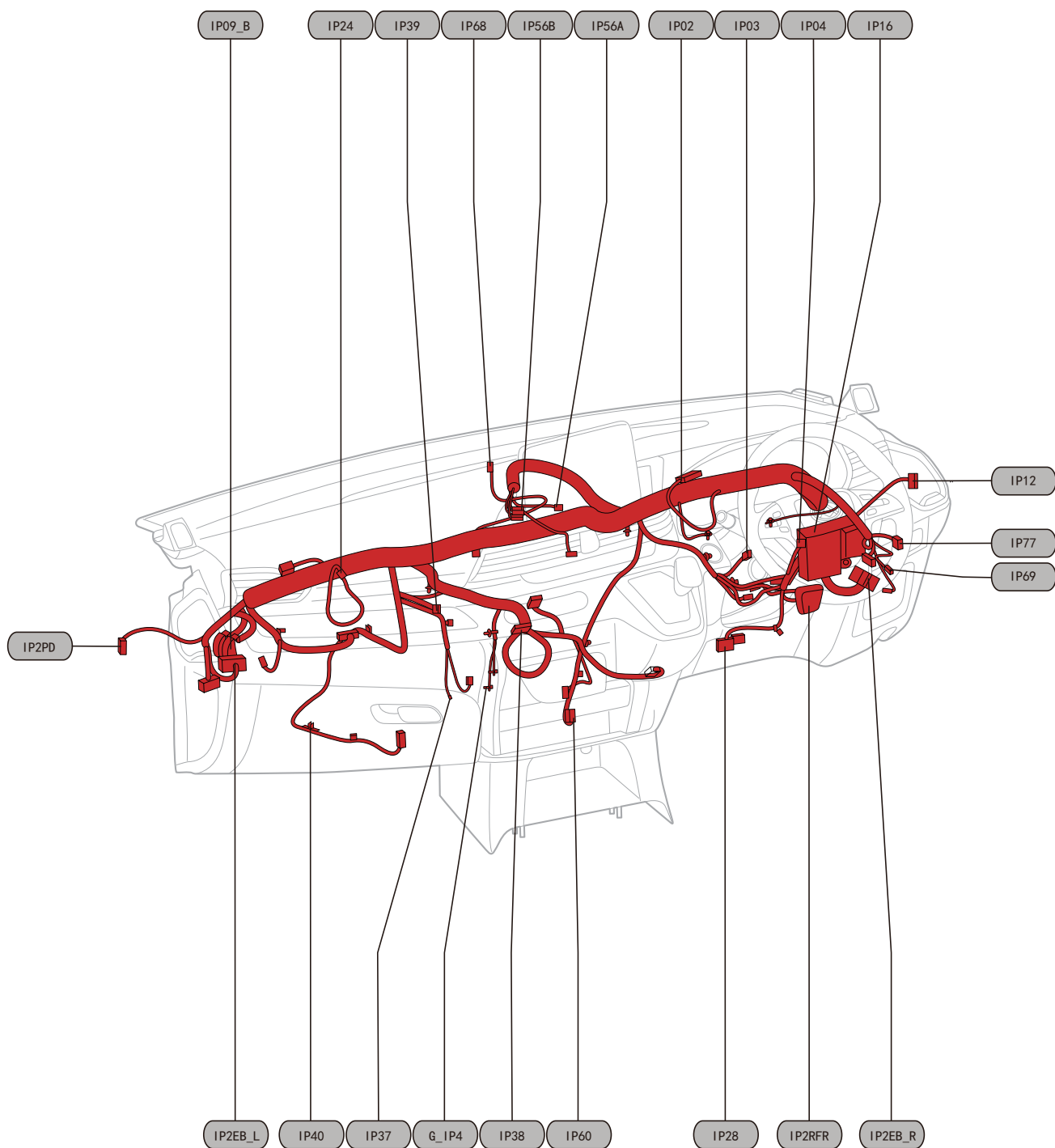

4.6.4 Instrument Harness 4 - Right rudder

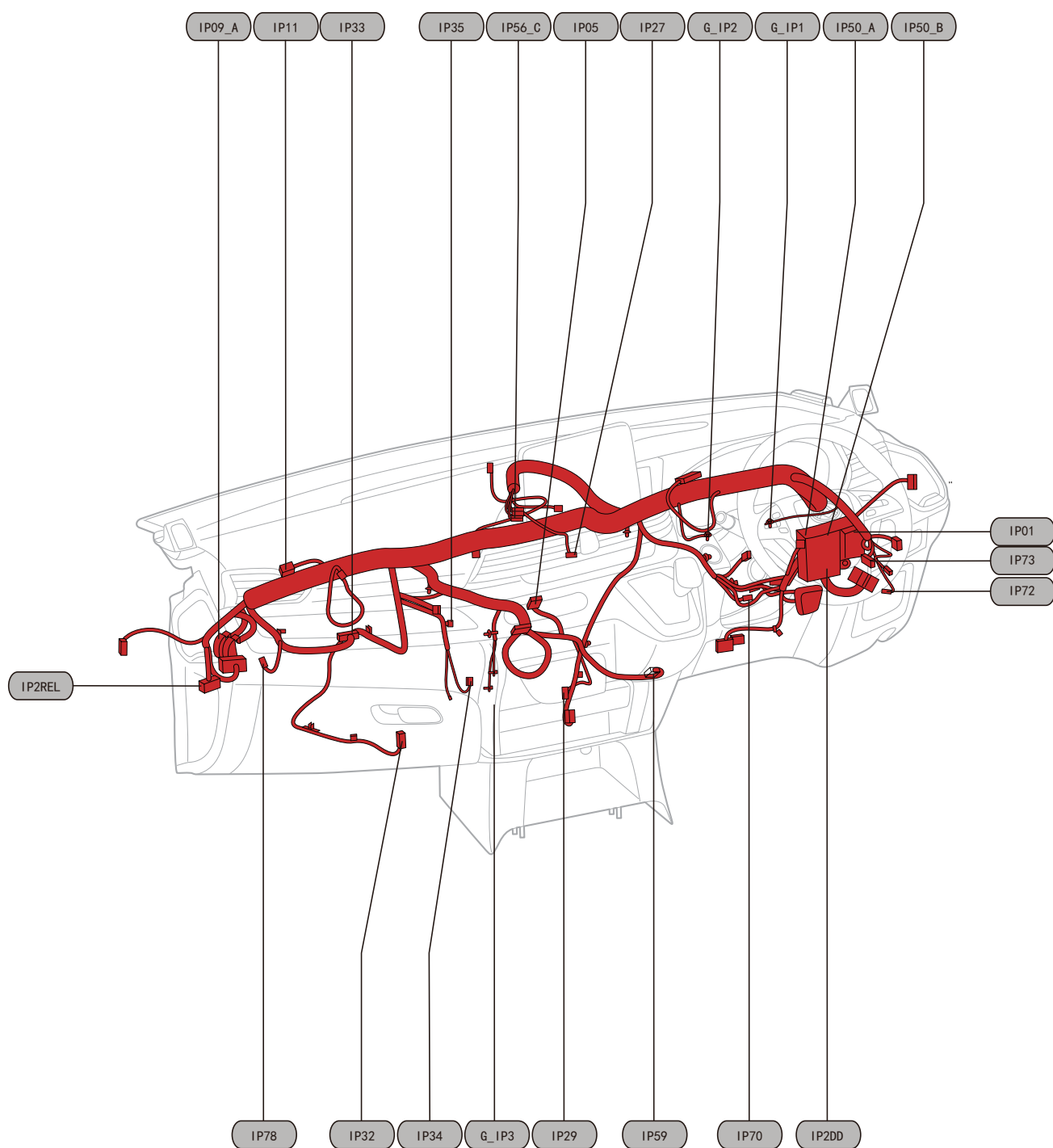

4.6.5 Instrument Harness IP

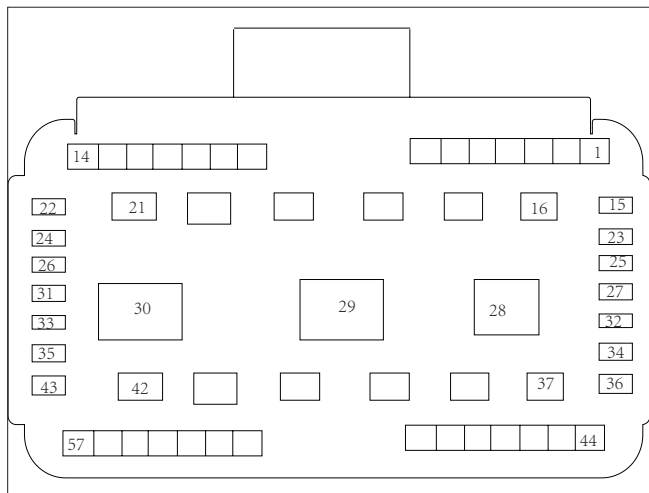

IP2EB-R 接前舱线束 R
ASM CONN 57 F 0.64X42 2.8X12 6.3X3

Pin No	Color	Functions	Re- marks
1	D-BU	电源	
2	D-BU/YE	CAN-H	
3	D-GN	HI BEAM PWR(HI)	
4	VT	FL TURN FAULT FEEDBACK	
5	D-GN/ WH	FR TURN FAULT FEEDBACK	
6	RD/BN	Main Beem_Right (High)	
7	D-BU/ L-GN	CAN-L	
8	YE	FRONT_WIPER_ PARK_SW	
9	BN	HOOD SW	
10	BK	接地	
11	BARE	CAN-H	
12	OG/D-GN	ANT+	
13	OG/WH	ANT-	
14	L-BU	电源	
15	-	-	
16	D-BU	TURN PWR	
17	WH	电源	
18	L-BU	电源	

Pin No	Color	Functions	Re- marks
19	L-GN/GY	电源	
20	VT/D-GN	电源	
21	OG/WH	OUTPUT	
22	YE	IGN1	
23	D-GN/RD	ANT+	
24	BN	DOOR_AJAR_RR_ SW	
25	D-GN	ANT-	
26	-	-	
27	WH/D-BU	Crash Output	
28	-	-	
29	-	-	
30	-	-	
31	OG	TEMP_AMB	
32	L-GN	FAD+	
33	VT	FAP+	
34	VT/D-GN	FAD-	
35	GY	FAP-	
36	YE	5V 电源	
37	-	-	
38	-	-	
39	-	-	
40	GY	OUTPUT_2	
41	BK/RD	SIG_1	
42	WH/GY	SIG_2	
43	BK/WH	SGND	
44	D-BU/OG	CAN_H	
45	D-BU/BK	CAN_L	
46	-	-	
47	D-BU/RD	CAN_H	
48	D-BU/BN	CAN_L	
49	VT/D-GN	LIN2	
50	-	-	
51	-	-	

Pin No	Color	Functions	Re- marks
52	-	-	
53	BRAN	屏蔽线	
54	D-BU/YE	CAN_H	
55	D-BU/ L-GN	CAN_L	
56	D-BU/VT	CAN_H	
57	D-BU/GY	CAN_L	

Pin No	Color	Functions	Re- marks
14	RD/WH	电源	
15	YE	电源	
16	RD	电源	
17	RD	电源	
18	VT/D-GN	TURN_LAMPS_L	
19	D-GN/GY	LIN	
20	-	-	
21	-	-	
22	YE	IG1	
23	D-BU	INTERNAL_LAMP_ POWER OUT	
24	-	-	
25	-	-	
26	VT/D-GN	VSO	
27	RD/BK	电源	
28	RD	电源	
29	L-GN	M+	
30	RD	电源	
31	WH	IGN	
32	D-BU	POWER	
33	L-GN	SIG	
34	YE	HORN_RELAY	
35	VT	RAP	
36	L-GN	SIG OUT	
37	RD/BK	电源	
38	RD/D-GN	电源	
39	D-BU	CAN_H	
40	GY/WH	CAN_L	
41	-	-	
42	-	-	
43	YE/WH	B+	
44	OG/BK	CAN_H	
45	OG/L-GN	CAN_L	
46	BARE	屏蔽线	

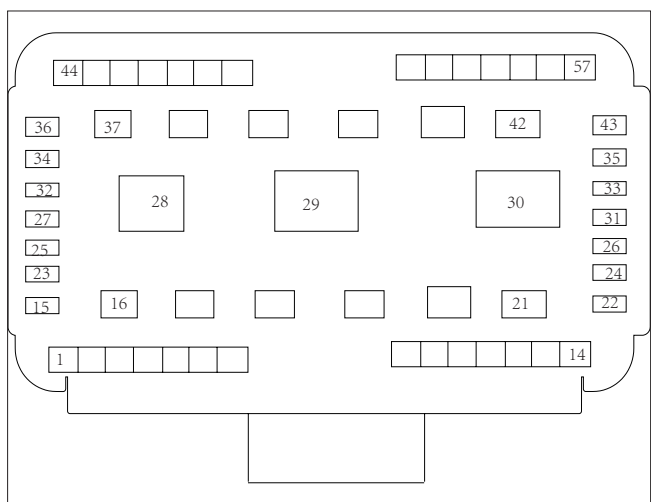

IP2EB-L 接前舱线束 L
ASM CONN 57 M 0.64X42 GET 2.8X12 6.3X3

Pin No	Color	Functions	Re- marks
1	VT	VIN-1	
2	D-BU	Signal-1	
3	BK	接地	
4	GY/VT	AVAS SIG	
5	PK/WH	AVAS Indicator	
6	L-GN/YE	CAN_L	
7	L-GN/BK	CAN_H	
8	D-GN/GY	LIN	
9	RD/D-GN	电源	
10	L-GN	ESP OFF SIG	
11	WH	ESP OFF IND	
12	D-BU/WH	MOTOR SIG	
13	RD/D-BU	MOTOR PWR	

Pin No	Color	Functions	Re- marks
47	BN/L-BU	CAN_H	
48	BN/VT	CAN_L	
49	BARE	屏蔽线	
50	D-BU	电源	
51	YE/BK	CAN_H	
52	YE/GY	CAN_L	
53	BARE	屏蔽线	
54	VT	R-PRESS_SENS	
55	OG	电源	
56	D-BU	REVERSE LAMPS	
57	VT/D-GN	电源	

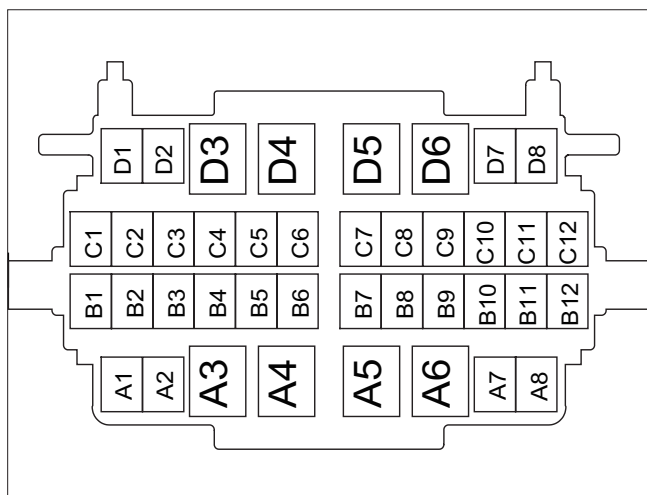

IP2RFR 接顶棚线束
CONN 40 M GT 150X32 280X8

Pin No	Color	Functions	Re- marks
A1	RD/BK	TURN	
A2	RD	电源	
A3	RD/WH	电源	
A4	-	-	
A5	-	-	
A6	-	-	
A7	WH/BK	PAS-SW	
A8	VT/WH	Indicator	

Pin No	Color	Functions	Re- marks
B1	VT	AUDIO RF+	
B2	GY	AUDIO RF-	
B3	OG	AUDIO RR+	
B4	VT/D-GN	AUDIO RR-	
B5	RD/D-BU	IG	
B6	GY	LCA_SIG	
B7	GY/WH	LCA_LED	
B8	VT	ACC	
B9	D-BU/WH	CAN_H	
B10	D-BU/ D-GN	CAN_L	
B11	-	-	
B12	-	-	
C1	-	-	
C2	-	-	
C3	-	-	
C4	-	-	
C5	-	-	
C6	-	-	
C7	-	-	
C8	-	-	
C9	RD/D-BU	电源	
C10	WH	DOOR_AJAR_ TRUNK_SW	
C11	-	-	
C12	-	-	
D1	-	-	
D2	-	-	
D3	-	-	
D4	-	-	
D5	-	-	
D6	-	-	
D7	-	-	
D8	-	-	

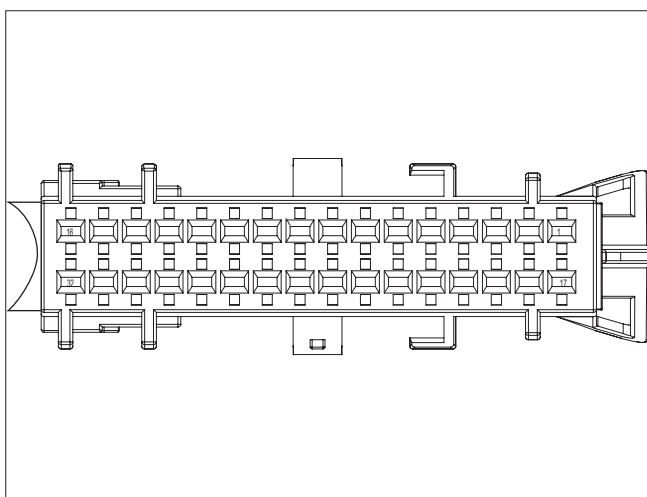

IP02 组合仪表
CONN 32F 0.64 MQS

Pin No	Color	Functions	Re- marks
22	GY	SET 2(HI/LO)	
23	WH/VT	SET 1(HI/LO)	
24	D-BU/BK	CAN_L	
25	D-BU/OG	CAN_H	
26	BK	接地	
27	-	-	
28	D-BU	PARKING BRAKE SIG	
29	L-GN	BRAKE LVL SEN	
30	BK	接地	
31	RD/BK	电源	
32	YE	电源	

Pin No	Color	Functions	Re- marks
1	-	-	
2	-	-	
3	-	-	
4	-	-	
5	-	-	
6	-	-	
7	-	-	
8	-	-	
9	-	-	
10	-	-	
11	-	-	
12	-	-	
13	-	-	
14	-	-	
15	-	-	
16	-	-	
17	-	-	
18	-	-	
19	-	-	
20	BK	接地	
21	L-GN	ANTI-THEFT WARNING LED+	

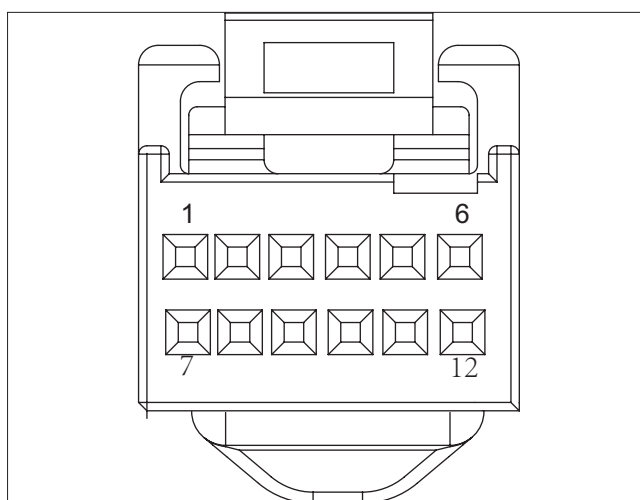

IP03 组合灯开关
CONN 12 F 025 NAT

Pin No	Color	Functions	Re- marks
1	BK	接地	
2	D-GN	TURN_R_SW	
3	-	-	
4	-	-	
5	BK/WH	MAIN BEAM FLASH SW	
6	BK	接地	
7	D-GN	COMBI LAMP	

Pin No	Color	Functions	Re- marks
8	GY	REAR FOG LP SW	
9	L-GN	FRONT_FOG_ LAMP_SW	
10	GY	SET2	
11	WH	TURN_L_SW	
12	VT/D-GN	MAIN BEAM SW	

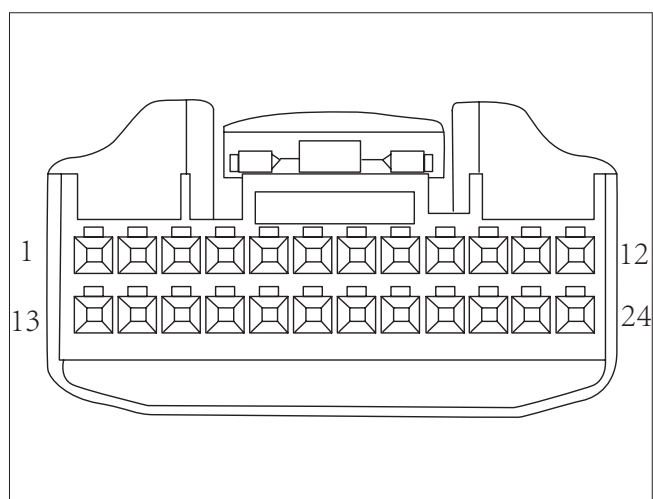

IP05 中央控制开关
1-1718346-1 AMP

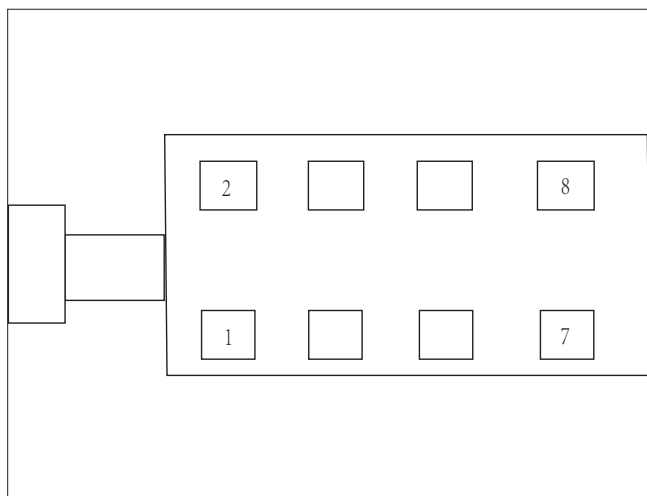

IP04 前雨刮组合开关
CONN 10 F 0.64 MQS BLK

Pin No	Color	Functions	Re- marks
1	BK	接地	
2	WH/VT	CLUSTER SET 1	
3	-	-	
4	-	-	
5	BK	接地	
6	YE	FRT WASH SIG	
7	GY	FRT WIPER SIG1	
8	BK	接地	
9	D-GN	FRT WIPER SIG2	
10	VT	INT SIG	

Pin No	Color	Functions	Re- marks
1	WH	ILL+	
2	BK	ILL-	
3	PK/WH	AVAS Indicator	
4	-	-	
5	GY	AVAS SIG	
6	L-GN	ESP OFF SIG	
7	L-GN	LDW SW	
8	WH/RD	AEB SW	
9	WH	SPORT/ECO SW+	
10	GY	AEB IND	
11	WH/BK	FRT RADAR SIG	
12	WH	LDW IND	
13	GY	AEB IND	
14	GY/WH	LCA_LED	
15	VT/WH	FRT RADAR Indicator	
16	RD/D-GN	电源	
17	WH	ESP OFF IND	
18	BK	SPORT/ECO SW-	
19	-	-	
20	-	-	
21	-	-	

Pin No	Color	Functions	Re- marks
22	-	-	
23	-	-	
24	-	-	

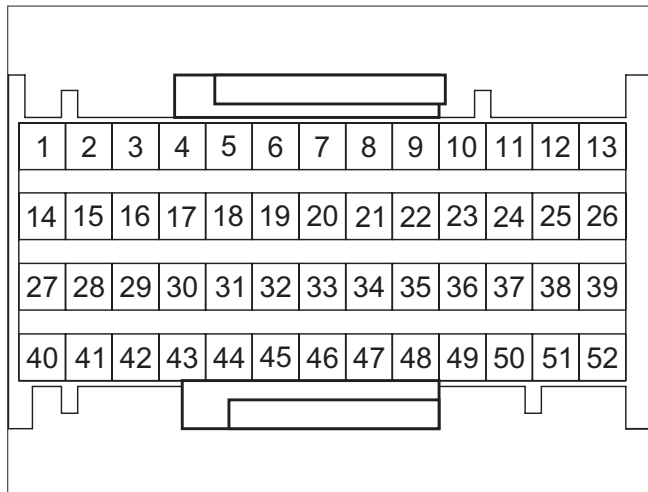

IP09_A 车身控制模块
ASM CONN 52 F 0.64

Pin No	Color	Functions	Re- marks
1	-	-	
2	WH	DRL_LEFT	
3	D-GN	MainBeam_ Left(High)	
4	BK	接地	
5	VT/D-GN	FRT FOG RELAY_ RH	
6	-	-	
7	-	-	
8	VT/D-GN	MAIN BEAM SW	
9	WH	KLR_SW	
10	WH/D-BU	CRASH_SIGNAL	
11	GY	FRT WIPER INPUT1	
12	-	-	
13	RD/BK	TURN_LAMPS_R_ REAR	
14	-	-	
15	-	-	

Pin No	Color	Functions	Re- marks
16	L-GN/GY	FRT FOG LEFT	
17	RD/BN	Main Beem_Right (High)	
18	YE	FRONT_WIPER_ PARK_SW	
19	-	-	
20	D-GN	FRT WIPER INPUT2	
21	OG	KL15_IGNITION_ SW	
22	BN	IgnitionSwitch	
23	L-BU	CDL_SNIB_LOCK_ FB_SW_Driver	
24	D-GN	TURN_R_SW	
25	-	-	
26	D-BU	TURN_LAMPS_R	
27	-	-	
28	-	-	
29	BK	接地	
30	-	-	
31	GY	AEB IND	
32	-	-	
33	VT	5V 电源	
34	L-BU	Master_Unlock	
35	GY	REAR FOG LP SW	
36	-	-	
37	D-BU/YE	CAN1_L	
38	OG	LIN1	
39	VT/D-GN	TURN_LAMPS_L	
40	VT	FL TURN FAULT FEEDBACK	
41	-	-	
42	-	-	
43	YE/WH	电源	
44	L-GN	SECURITY_ TELLTALE	
45	-	-	

Pin No	Color	Functions	Re- marks
46	YE	HAZARD SW	
47	L-BU/RD	CDL_SNIB_LOCK_ FB_SW_Passenger	
48	-	-	
49	WH	TURN_L_SW	
50	D-BU/RD	CAN1_H	
51	VT/D-GN	LIN2	
52	WH/RD	TURN_LAMPS_L_ REAR	

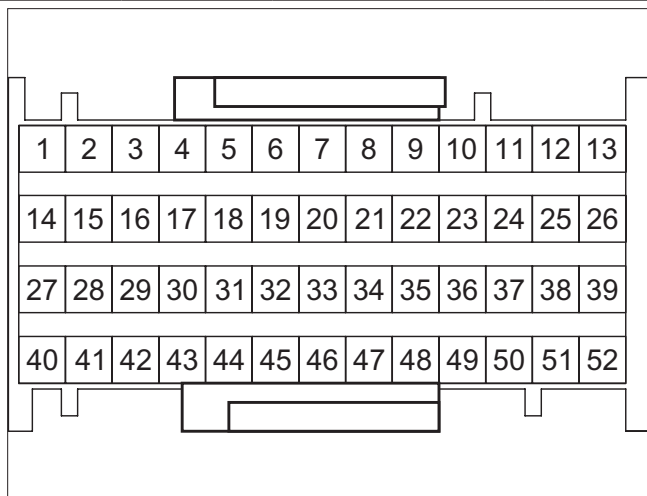

IP09_B 车身控制模块
ASM CONN 52 F 0.64

Pin No	Color	Functions	Re- marks
1	-	-	
2	-	-	
3	WH	电源	
4	BK/WH	MAIN BEAM FLASH SW	
5	WH	SPORT/ECO SW	
6	VT	FRONT_WIPER_ INT_LEVEL	
7	VT/D-GN	SOLAR & LIGHT SIG	
8	BK	接地	
9	WH	ILL+	
10	BK/WH	CHMSL	

Pin No	Color	Functions	Re- marks
11	WH/RD	AEB SW SIG	
12	-	-	
13	-	-	
14	-	-	
15	L-BU	ACC	
16	L-GN	DIMMER SW	
17	-	-	
18	YE	FRONT_WASH_ SW	
19	-	-	
20	D-GN	COMBI LAMP	
21	-	-	
22	BN	HOOD SW	
23	-	-	
24	VT	ACC SW	
25	D-GN/ WH	FR TURN FAULT FEEDBACK	
26	BK	接地	
27	-	-	
28	-	-	
29	YE	HORN_RELAY	
30	-	-	
31	D-BU/YE	Start Stop Switch 1	
32	BN	DOOR_AJAR_ RR_ SW	
33	-	-	
34	-	-	
35	BK/WH	REAR_INTERNAL_ LAMP_SW	
36	GY	DOOR_AJAR_ PASS_SW	
37	-	-	
38	-	-	
39	-	-	
40	-	-	
41	D-BU	REVERSE LAMPS	

Pin No	Color	Functions	Re- marks
42	-	-	
43	L-BU	DRL_RIGHT	
44	L-GN	FRONT_FOG_LAMP_SW	
45	L-BU	DOOR_AJAR_RL_SW	
46	YE	Master_Lock	
47	-	-	
48	-	-	
49	WH	DOOR_AJAR_TRUNK_SW	
50	BN	DOOR_AJAR_DRV_SW	
51	D-BU	BRAKE PEDAL SNESOR	
52	-	-	

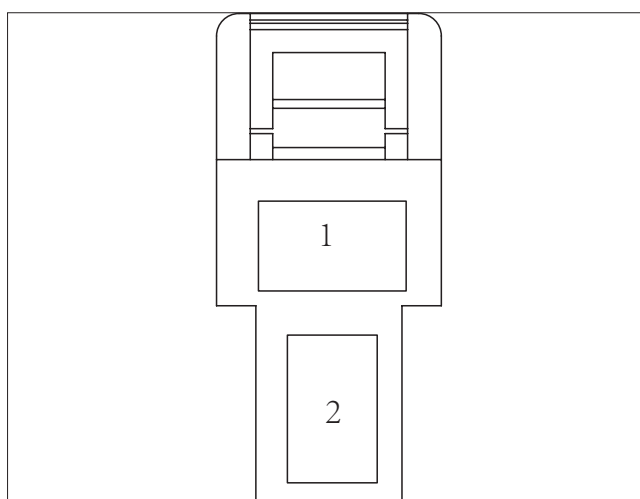

IP11 BD 电阻器
CONN 2 F NAT

Pin No	Color	Functions	Re- marks
1	D-BU/RD	CAN_H	
2	D-BU/YE	CAN_L	

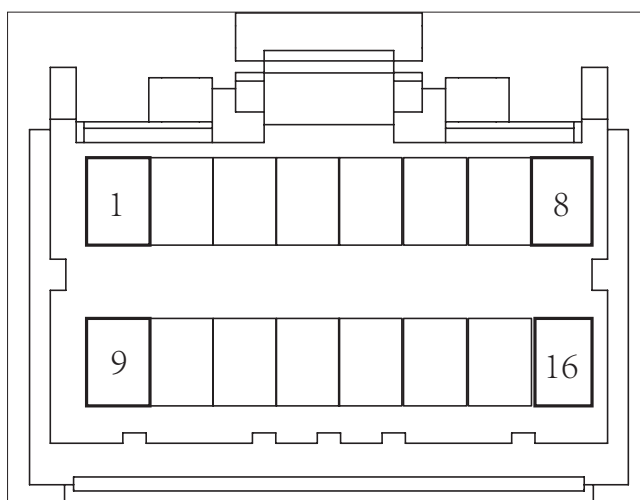

IP12 后视镜和调光开关
174046-2

Pin No	Color	Functions	Re- marks
1	WH	ILL+	
2	L-GN/YE	XY COMMON	
3	D-GN/BN	XY COMMON	
4	L-GN/WH	X MTR	
5	-	-	
6	L-GN	L&R Y MTR	

Pin No	Color	Functions	Re- marks
7	VT	X MTR	
8	VT	ACC	
9	BK	接地	
10	RD/D-BU	电源	
11	BK	接地	
12	-	-	
13	-	-	
14	L-GN	DIMMER SW BCM_ IN	
15	BK	接地	
16	D-BU/WH	HEADLAMP LEVELING SW OUT	

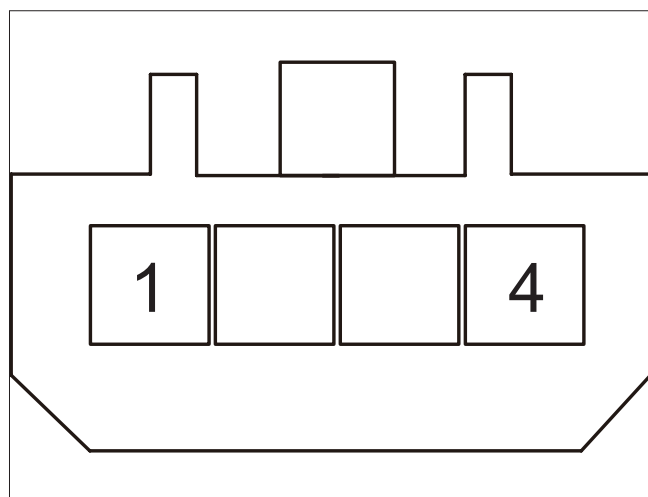

IP16 IMMO
CONN 4 F 025 NAT

Pin No	Color	Functions	Re- marks
1	RD	PWR+	
2	BK	接地	
3	OG	LIN	
4	WH	LED+	

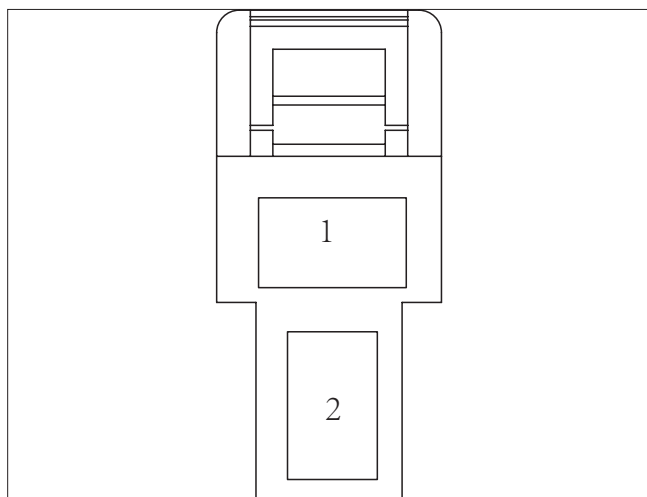

IP13 电阻器
CONN 2 F NAT

Pin No	Color	Functions	Re- marks
1	D-BU/VT	CAN_H	
2	D-BU/GY	CAN_L	

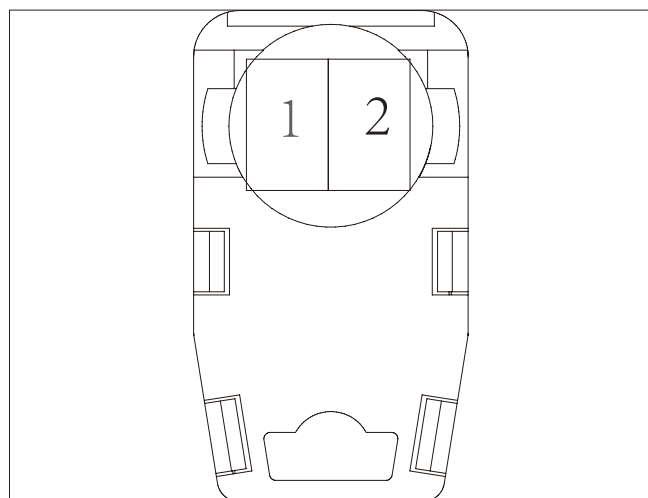

IP24 前排乘客安全气囊
35365031X

Pin No	Color	Functions	Re- marks
1	L-GN	FAP+	
2	OG	FAP-	

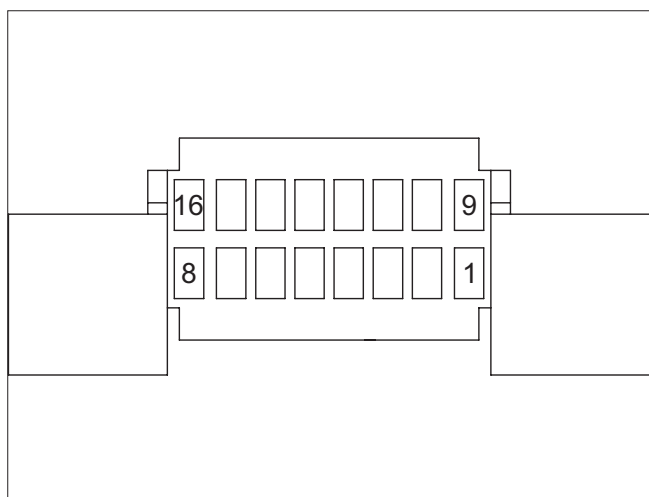

IP28 OBD
1563113-3 AMP

Pin No	Color	Functions	Re- marks
1	BN/L-BU	DC-Charge H	
2	BN/VT	DC-Charge L	
3	-	-	
4	BK	接地	
5	BK	接地	
6	D-BU/VT	CAN_H	
7	-	-	
8	-	-	
9	L-GN/BK	EVCC-H	
10	L-GN/YE	EVCC-L	
11	-	-	
12	-	-	
13	-	-	
14	D-BU/GY	CAN_L	
15	-	-	
16	RD/GY	电源	

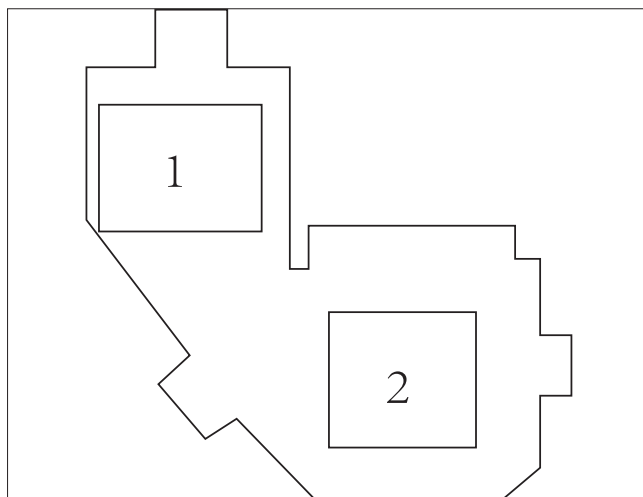

IP29 点烟器
CONN 2 F 250 BLK

Pin No	Color	Functions	Re- marks
1	BN	电源	
1	BK	接地	

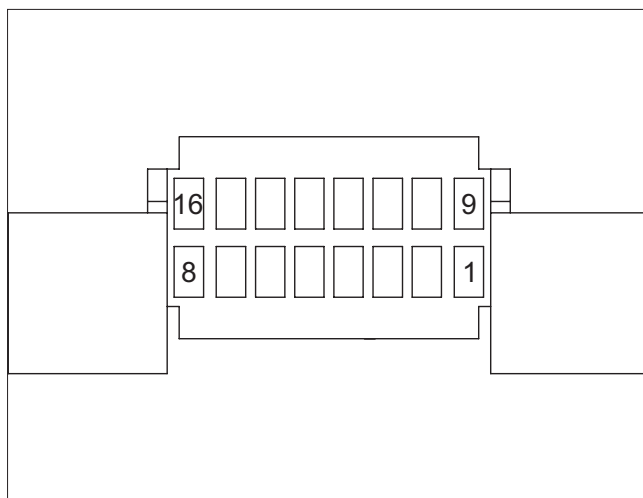

IP30 OBD(develop)
CONN 16 F BLK

Pin No	Color	Functions	Re- marks
1	YE/BK	CAN_H	
2	YE/GY	CAN_L	
3	D-BU/RD	CAN_H	
4	BK	接地	
5	BK	接地	

Pin No	Color	Functions	Re- marks
6	D-BU/YE	CAN_H	
7	D-BU	CAN_H	
8	GY/WH	CAN_L	
9	D-BU/OG	CAN_H	
10	D-BU/BK	CAN_L	
11	D-BU/YE	CAN_L	
12	D-BU/WH	CAN_H	
13	D-BU/ D-GN	CAN_L	
14	D-BU/ L-GN	CAN_L	
15	-	-	
16	RD/GY	电源	

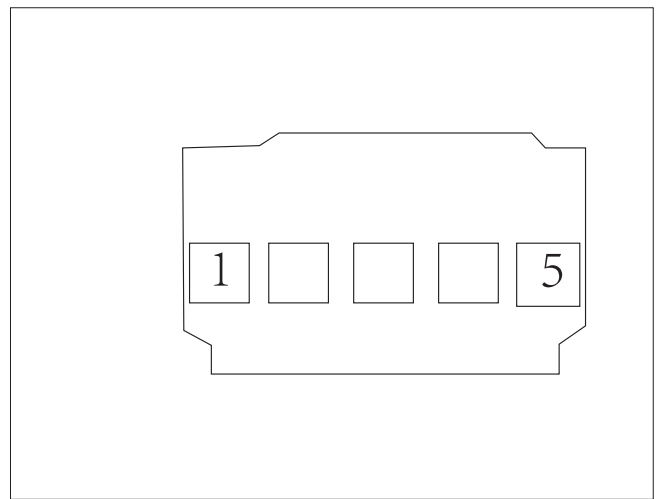

IP33 内循环风门电机
7283-5830

Pin No	Color	Functions	Re- marks
1	BK/WH	接地	
2	BN	FRS/REC FB	
3	YE	5V	
4	BN	M-	
5	VT	M+	

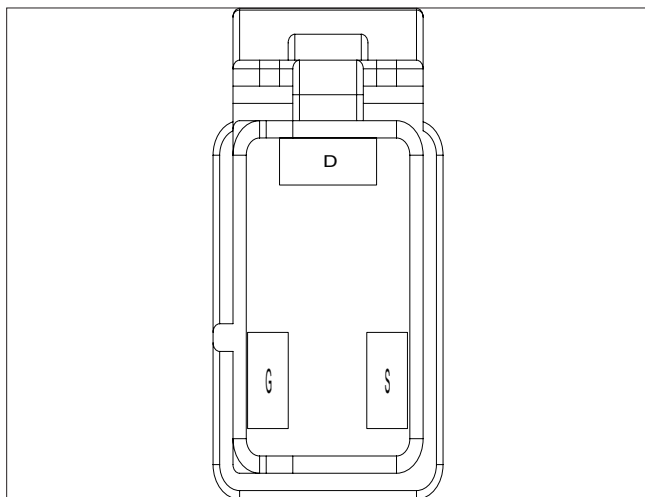

IP32 前鼓风机调速电阻
CONN 3 F 6.3 NAT SLD

Pin No	Color	Functions	Re- marks
D	D-BU	BLOWER FB	
S	BK	接地	
G	OG	CONTROL SIG	

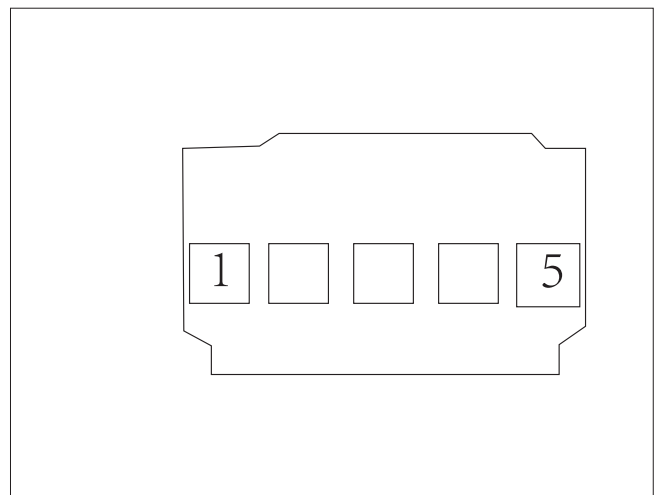

IP34 冷暖电机
7283-5830

Pin No	Color	Functions	Re- marks
1	BK/WH	接地	
2	VT	TEMP FB	

Pin No	Color	Functions	Re- marks
3	YE	5V	
4	VT/D-GN	M+	
5	D-BU	M-	

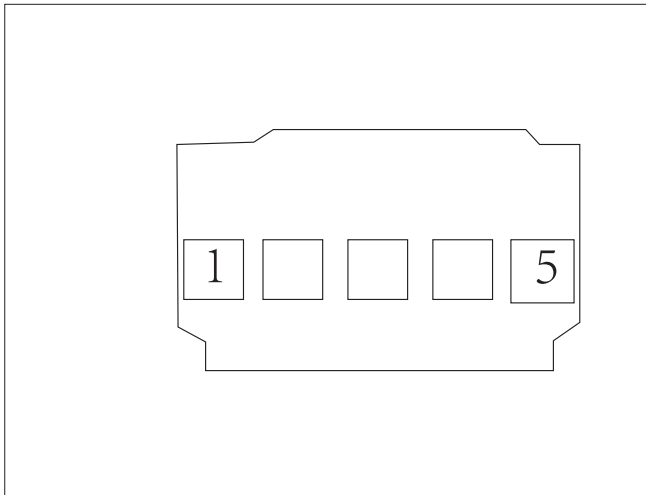

IP35 模式电机
7283-5830

Pin No	Color	Functions	Re- marks
1	BK/WH	接地	
2	D-GN	MODE FB	
3	YE	5V	
4	WH	M-	
5	GY	M+	

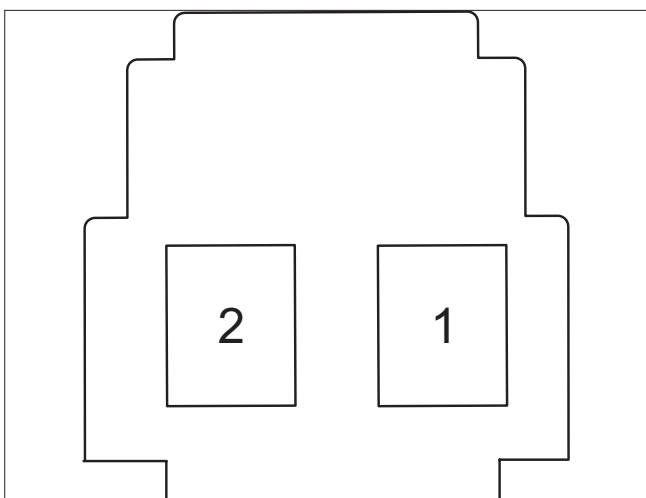

IP37 EVAP TMP SEN-F

CONN 2 F WHT

Pin No	Color	Functions	Re- marks
1	BK/WH	接地	
2	BN	F-TEMP_EVAP	

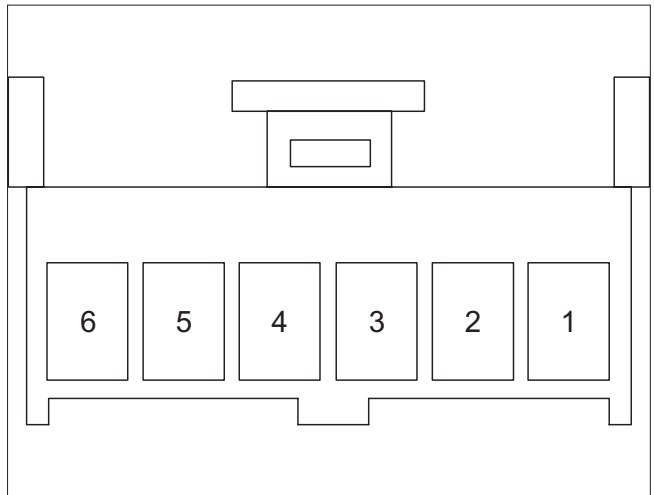

IP39 SOLAR & LIGHT SENSOR
CONN 6 F 040 MULTI-LOCK BLK

Pin No	Color	Functions	Re- marks
1	D-BU	SENSOR PWR	
2	-	-	
3	-	-	
4	-	-	
5	VT/D-GN	SENSOR SIG	
6	BK	接地	

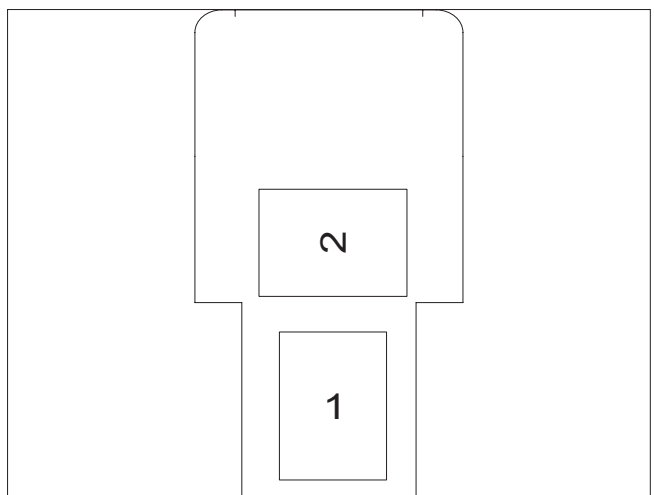

IP40 前鼓风机
CONN 2 F 250 NAT

Pin No	Color	Functions	Re- marks
1	L-GN	M+	
2	D-BU	M-	

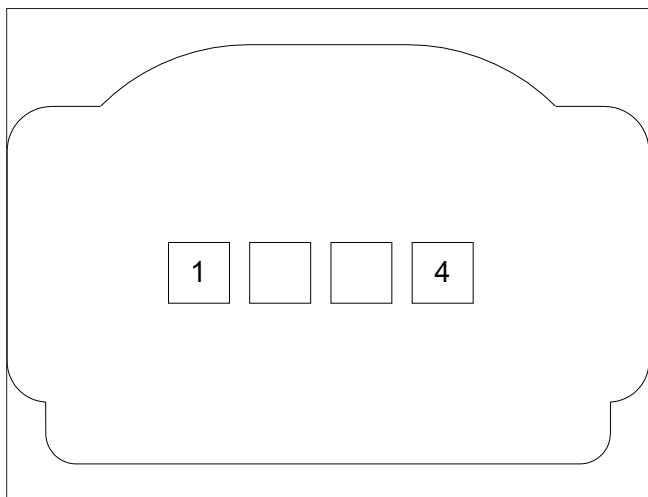

IP50_A 时钟弹簧 (HI)
ASM CONN 4 F 040 III YEL

Pin No	Color	Functions	Re- marks
1	YE	HORN+	
2	BK	HORN-	
3	L-GN	DAB+	
4	VT/D-GN	DAB-	

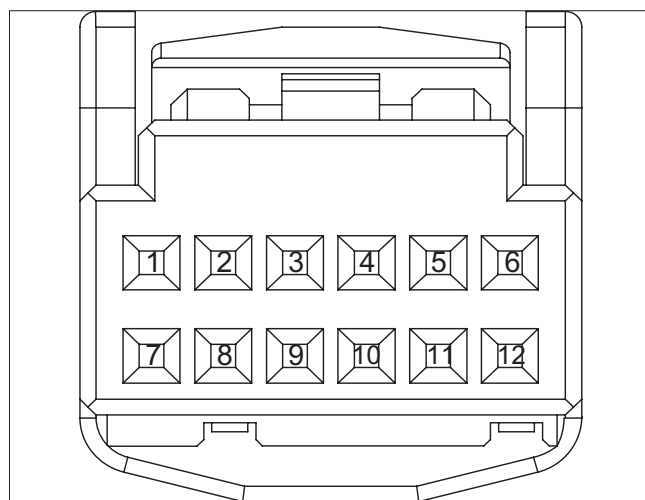

IP50_B 时钟弹簧
CONN 12 F 025 BLK

Pin No	Color	Functions	Re- marks
1	WH	SW1	
2	VT/D-GN	SW2	
3	BK	SW COMMON	
4	-	-	
5	-	-	
6	-	-	
7	VT	CRUISE+	
8	BK	CRUISE-	
9	WH/VT	SET1	
10	GY	SET2	
11	BK	ILL-	
12	WH	ILL+	

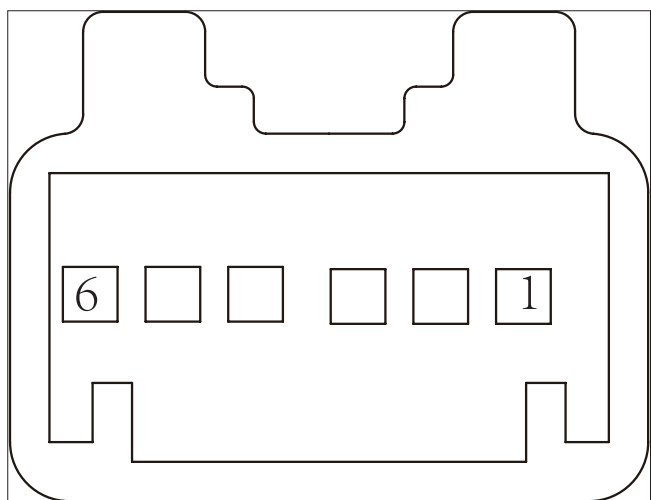

IP54_A 点火开关
CONN 6 F 0.8 NAT

Pin No	Color	Functions	Re- marks
2	WH/BK	BATT FROM KEY-IN SW	
3	D-BU	电源	
4	BK	接地	

Pin No	Color	Functions	Re- marks
1	OG	RUN/CRANK	
2	RD	电源	
3	WH	ACCESSORY	
4	WH/BK	TO KEY-IN SW	
5	BN	OFF/RUN/CRANK	
6	VT	REGULATED POWER	

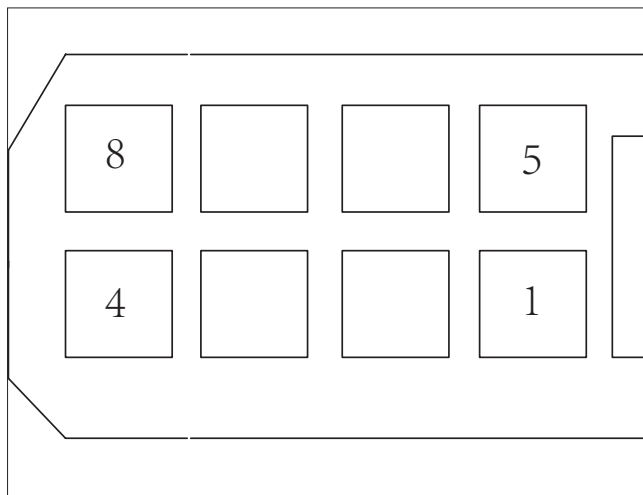

IP55_A 收音机 /MP5
98685-1001

Pin No	Color	Functions	Re- marks
1	OG	AUDIO RR+	
2	VT	AUDIO RF+	
3	D-BU	AUDIO LF+	
4	WH	AUDIO LR+	
5	VT/D-GN	AUDIO RR-	
6	GY	AUDIO RF-	
7	YE	AUDIO LF-	
8	D-GN	AUDIO LR-	

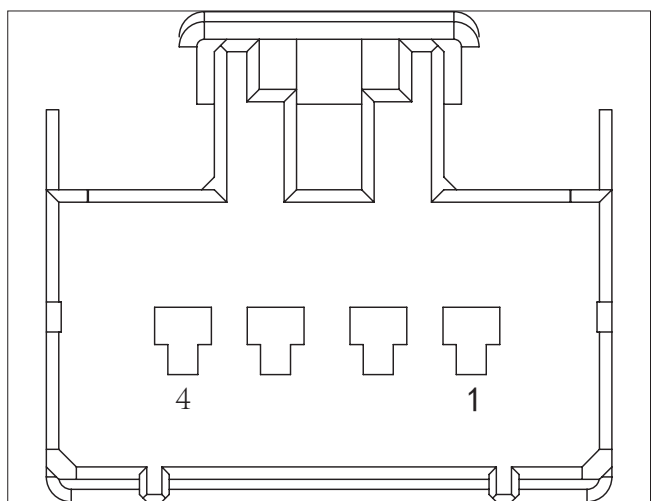

IP54_B 点火开关
MG651038

Pin No	Color	Functions	Re- marks
1	BN	KEY-IN TO PMM	

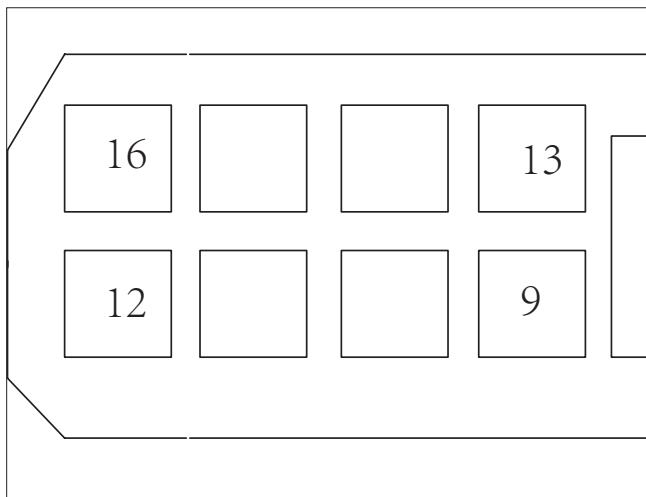

IP55_B 收音机 /MP5
98681-1002

Pin No	Color	Functions	Re- marks
9	-	-	
10	-	-	
11	WH	KEY(FR)	
12	-	-	
13	-	-	
14	-	-	
15	RD	电源	
16	BK	接地	

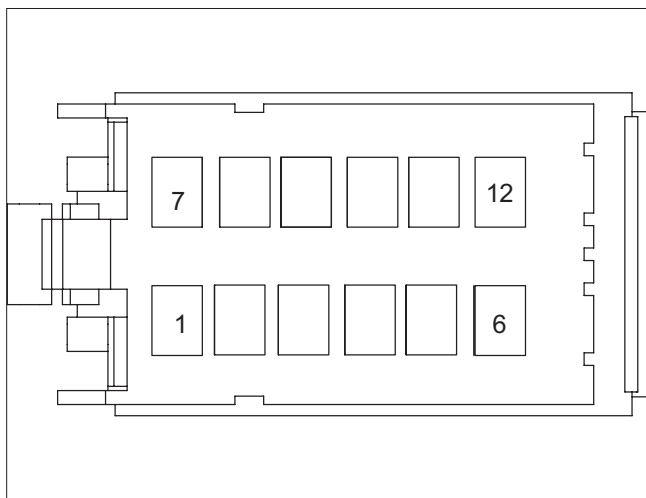

IP55_D 收音机 /MP5
98684-0001

Pin No	Color	Functions	Re- marks
1	-	-	
2	-	-	
3	BK	接地	
4	WH	SWC1+	
5	BARE	MIC-	
6	D-BU/OG	CAN_H	
7	-	-	
8	-	-	
9	-	-	
10	VT/D-GN	SWC2+	
11	D-BU/RD	MIC+	
12	D-BU/BK	CAN_L	

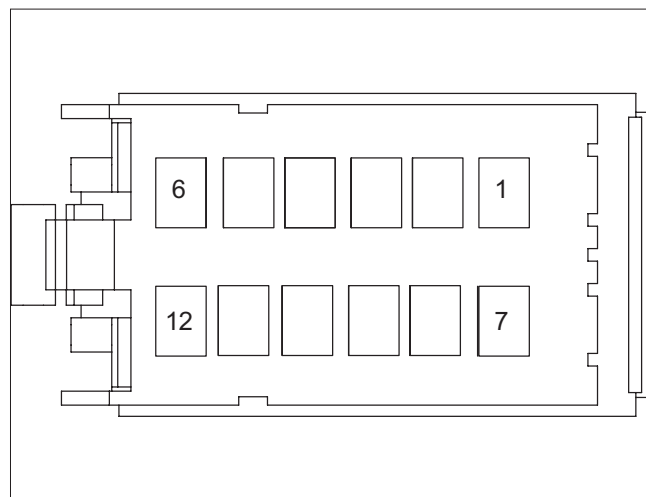

IP55_E 收音机 /MP5
98684-0002

Pin No	Color	Functions	Re- marks
1	-	-	
2	D-BU/BN	MIC2+	
3	-	-	
4	BK	接地	
5	WH	REAR CAMERA CVBS	
6	-	-	

Pin No	Color	Functions	Re- marks
7	WH	CNTR STACK ENABLE	
8	BARE	MIC2-	
9	-	-	
10	-	-	
11	BARE	屏蔽线	
12	-	-	

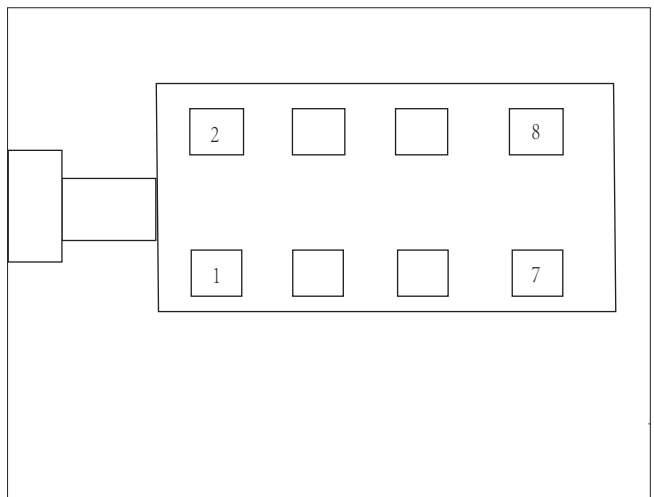

IP56_B 收音机 /MP3
347781-1

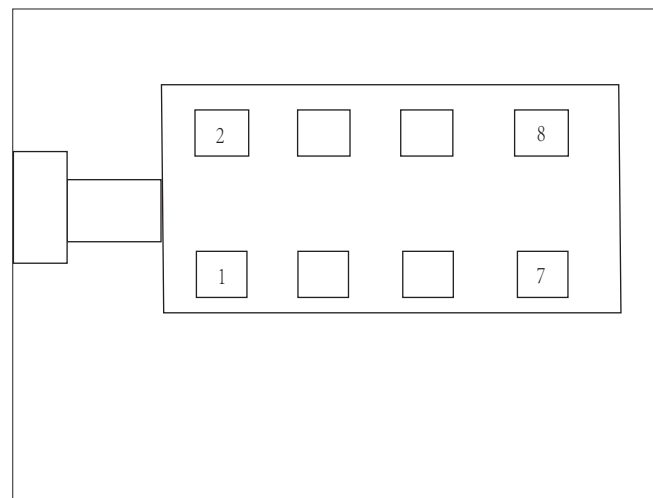

IP56_A 收音机 /MP3
347782-1

Pin No	Color	Functions	Re- marks
1	OG	Rear Right+	
2	VT/D-GN	Rear Right-	
3	VT	Front Right+	
4	GY	Front Right-	
5	D-BU	Front Left+	
6	YE	Front Left-	
7	WH	Rear Left+	
8	D-GN	Rear Left-	

Pin No	Color	Functions	Re- marks
1	BARE	MIC-	
2	YE	REVERSE SIG	
3	D-GN	MIC+	
4	VT	ACC	
5	-	-	
6	WH	ILLUM_IN	
7	RD	电源	
8	BK	接地	

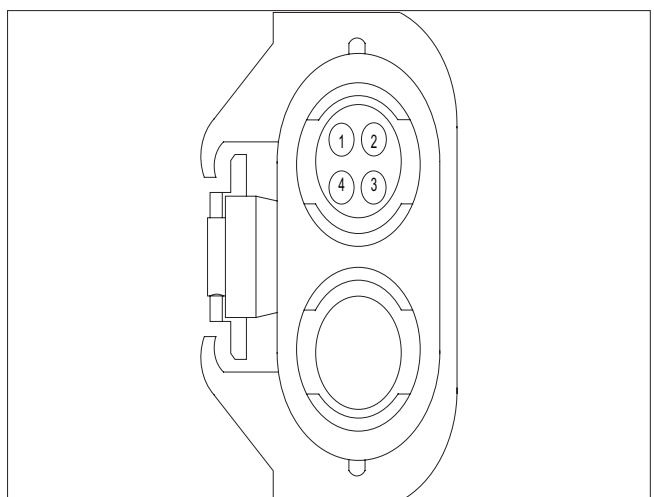

IP56_C 收音机 /MP3
3 022 02 35

Pin No	Color	Functions	Re- marks
13	-	-	
14	-	-	
15	-	-	
16	-	-	
17	BK	接地	
18	-	-	
19	WH	SWC2	
20	YE	SWC1	

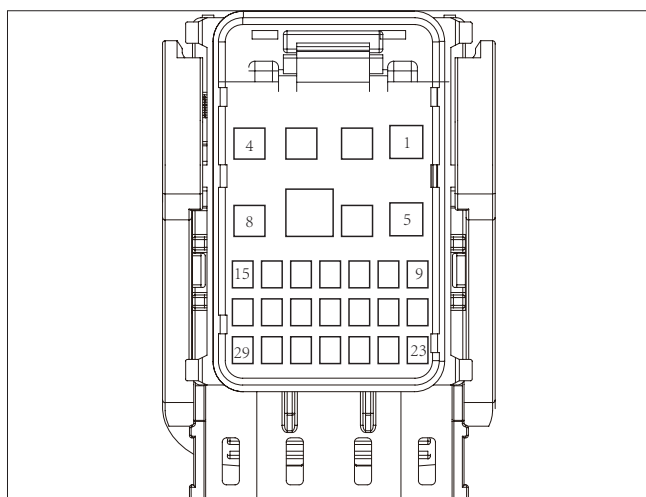

IP58_A 收音机 /MP5
160014-0002

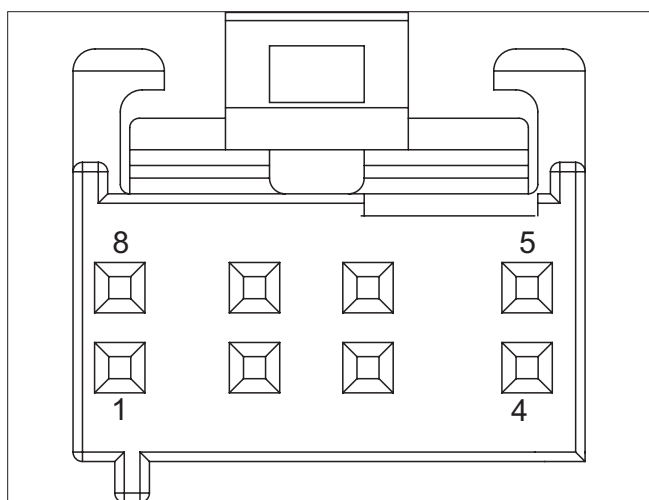

IP57 显示屏
174044-1

Pin No	Color	Functions	Re- marks
1	-	-	
2	-	-	
3	WH	ENABLE	
4	-	-	
5	RD/BK	电源	
6	BK	接地	
7	-	-	
8	-	-	

Pin No	Color	Functions	Re- marks
1	YE	Audio LF-	
2	D-BU	Audio LF+	
3	VT	Audio RF+	
4	GY	Audio RF-	
5	BK	接地	
6	BK	接地	
7	-	-	
8	-	-	
9	WH		
10	BK	接地	
11	VT/D-GN	MIC1 +	
12	-	-	
13	-	-	
14	GY	CVBS R+	
15	BARE	CVBS R-	
16	WH	MIC1 +	
17	BARE	MIC1 -	
18	D-BU/RD	MIC+	
19	BARE	MIC-	
20	-	-	
21	-	-	
22	-	-	

Pin No	Color	Functions	Re- marks
23	-	-	
24	-	-	
25	-	-	
26	-	-	
27	-	-	
28	-	-	
29	-	-	

Pin No	Color	Functions	Re- marks
14	D-BU/BK	CAN_L	
15	D-BU/OG	CAN_H	
16	-	-	
17	-	-	
18	-	-	
19	-	-	
20	-	-	
21	-	-	
22	-	-	
23	-	-	
24	-	-	
25	-	-	
26	-	-	
27	-	-	
28	BK	接地	
29	-	-	

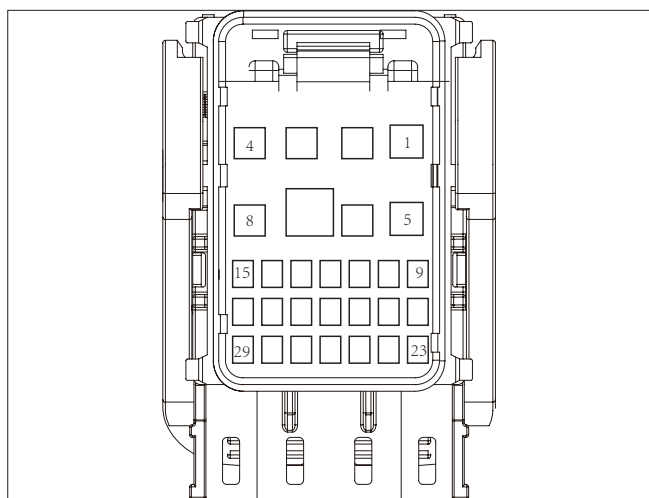

IP58_B 收音机 /MP5
160014-0003

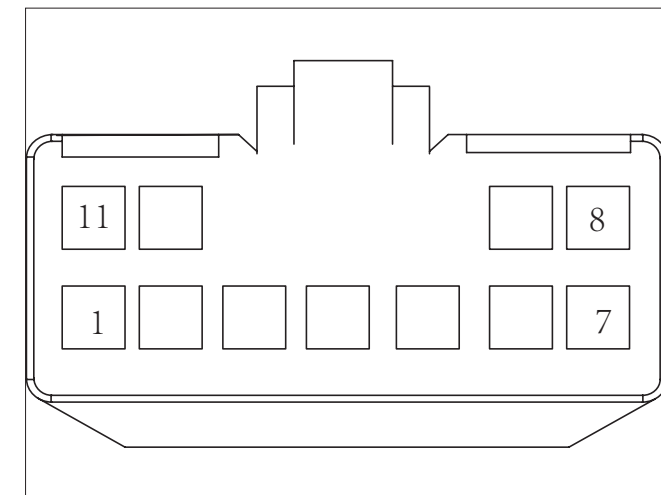

IP59 变速器
MG651350

Pin No	Color	Functions	Re- marks
1	OG	Audio RR+	
2	VT/D-GN	Audio RR-	
3	WH	Audio LR+	
4	D-GN	Audio LR-	
5	RD	电源	
6	RD	电源	
7	-	-	
8	-	-	
9	-	-	
10	-	-	
11	WH	FCDEn	
12	WH	HOME_KEY	
13	-	-	

Pin No	Color	Functions	Re- marks
1	VT	电源	
2	BK	接地	
3	VT/D-GN	LIN	
4	GY	P SHIFT SW OUT	
5	WH	ILL+	

线束分布及电器元件引脚定义 4-90

Pin No	Color	Functions	Re- marks
6	YE	电源	
7	-	-	
8	-	-	
9	-	-	
10	-	-	
11	-	-	

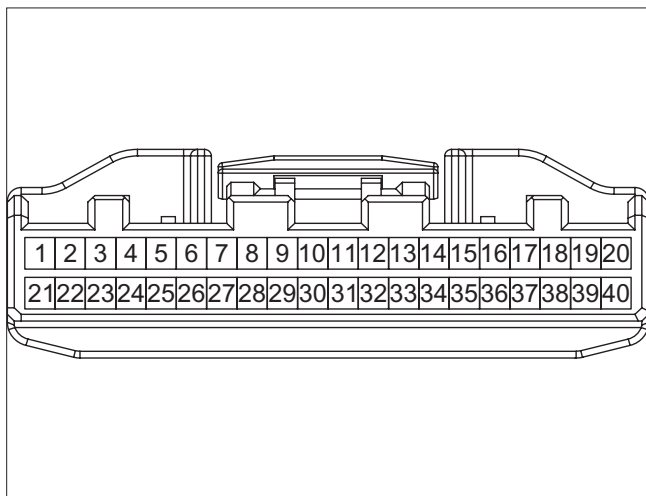

IP60_A T-BOX
2325415-1

Pin No	Color	Functions	Re- marks
1	-	-	
2	-	-	
3	BK	接地	
4	-	-	
5	-	-	
6	-	-	
7	-	-	
8	-	-	
9	-	-	
10	-	-	
11	-	-	
12	-	-	

Pin No	Color	Functions	Re- marks
13	-	-	
14	-	-	
15	-	-	
16	-	-	
17	-	-	
18	D-BU/ L-GN	CAN_L	
19	D-BU/VT	CAN_H	
20	RD/BK	电源	
21	-	-	
22	-	-	
23	-	-	
24	-	-	
25	-	-	
26	-	-	
27	-	-	
28	-	-	
29	-	-	
30	-	-	
31	-	-	
32	-	-	
33	-	-	
34	-	-	
35	-	-	
36	-	-	
37	-	-	
38	D-BU/YE	CAN_H	
39	D-BU/GY	CAN_L	
40	BK	接地	

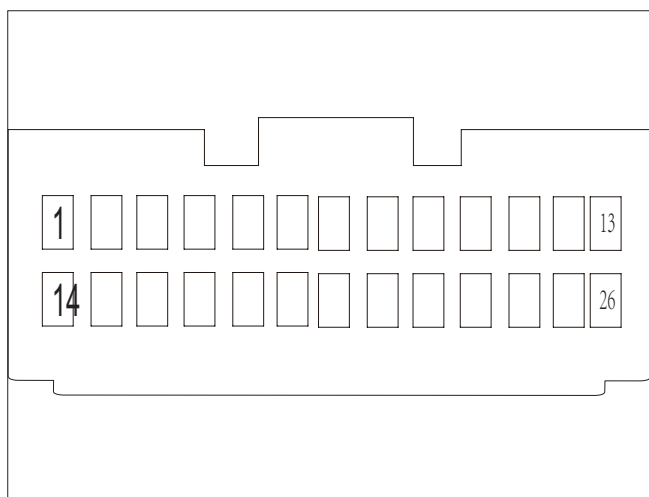

IP70_1 一键启动
LD5-963-1150-A-B

Pin No	Color	Functions	Re- marks
1	RD/BN	电源	
2	RD/BN	电源	
3	-	-	
4	L-GN/RD	DRVIER_DOOR_SW	
5	-	-	
6	-	-	
7	-	-	
8	-	-	
9	VT	ACC	
10	-	-	
11	-	-	
12	YE/D-BU	IMMO_LIN	
13	-	-	
14	BK	接地	
15	BK	接地	
16	VT/D-GN	V_SPEED	
17	WH/RD	PASS_DOOR_SW	
18	-	-	
19	-	-	
20	-	-	
21	YE	IG1	
22	-	-	

Pin No	Color	Functions	Re- marks
23	-	-	
24	OG/BK	IMMO_PWR	
25	L-GN	IMMO_GND	
26	-	-	

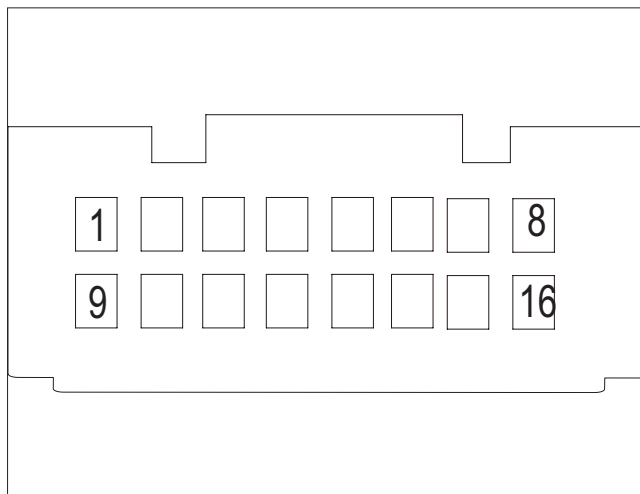

IP70_2 一键启动
917981-1

Pin No	Color	Functions	Re- marks
1	PK	SSB_LED2	
2	-	-	
3	-	-	
4	D-BU/WH	ACC_IGN_CTL	
5	GY/D-GN	Crank_RUN_CTL	
6	-	-	
7	D-BU/RD	CAN_H	
8	-	-	
9	-	-	
10	L-GN/PK	SSB_LED1	
11	OG	SSB_SW1	
12	-	-	
13	OG/BK	SSB_GND1	
14	-	-	
15	D-BU/YE	CAN_L	
16	GY	AT_P	

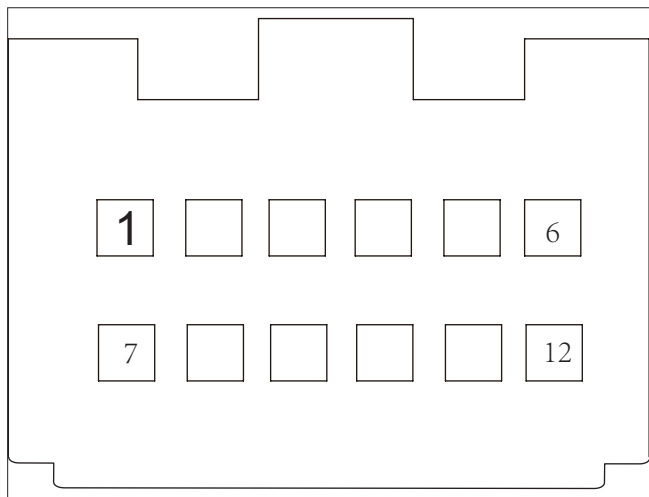

IP70_3 一键启动
917978-1

Pin No	Color	Functions	Re- marks
1	WH/VT	ANT1_POS	
2	OG/D-GN	ANT3_POS	
3	L-BU/YE	ANT2_POS	
4	D-GN/RD	ANT4_POS	
5	-	-	
6	-	-	
7	WH/GY	ANT1_NEG	
8	OG/WH	ANT3_NEG	
9	L-BU/BK	ANT2_NEG	
10	D-GN	ANT4_NEG	
11	-	-	
12	-	-	

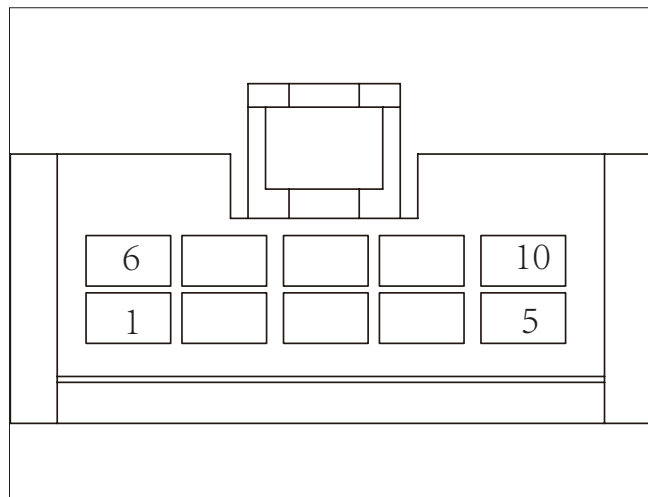

IP71 SSB
43025-1000

Pin No	Color	Functions	Re- marks
1	WH	SSB_LED	
2	L-GN/PK	SSB_LED1	
3	PK	SSB_LED2	
4	OG	SSB_SW1	
5	OG/BK	接地	
6	D-BU/YE	SSB_SW2	
7	BK	接地	
8	BK	接地	
9	-	-	
10	-	-	

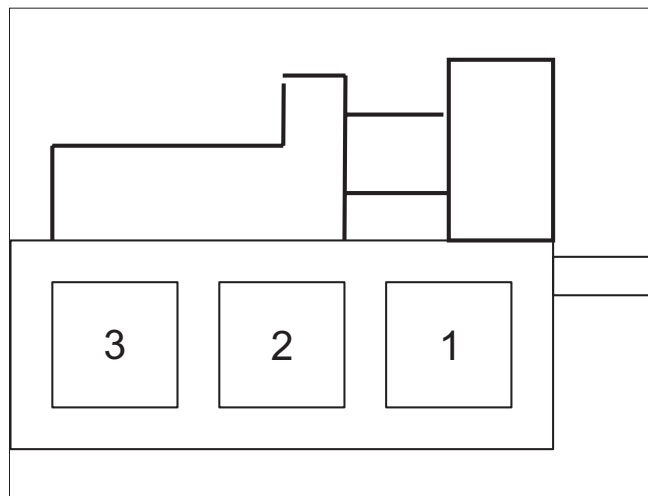

IP72 IMMO_PEPS
9-1718346-1

Pin No	Color	Functions	Re- marks
1	OG/BK	电源	
2	YE/D-BU	IMMO_LIN	
3	L-GN	接地	

Pin No	Color	Functions	Re- marks
2	BK	接地	
3	OG/WH	OUTPUT_1	
4	GY	OUTPUT_2	

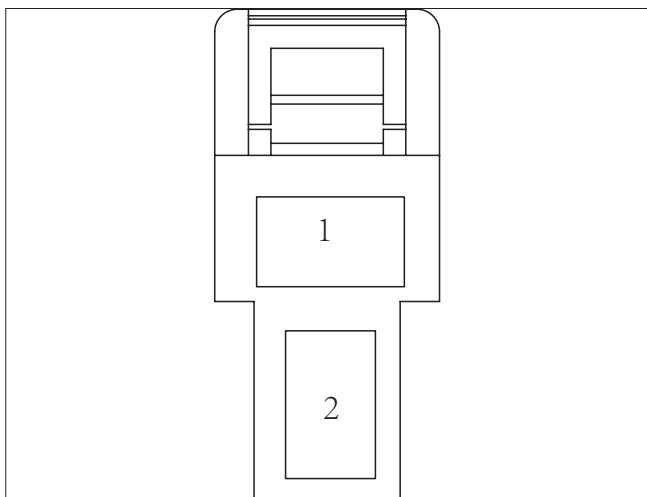

IP73 SOS 报警开关
0300401

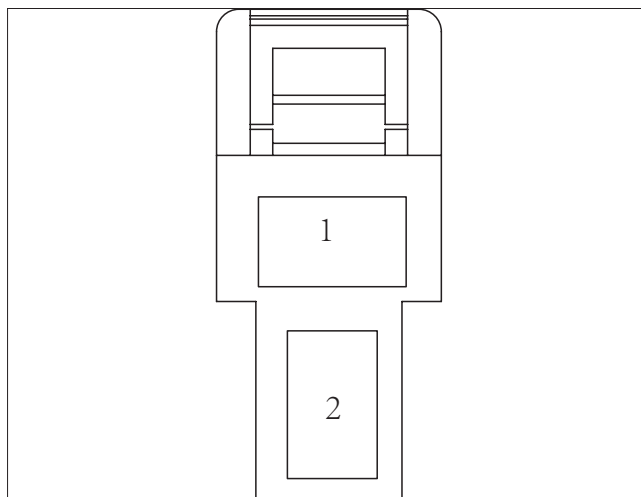

IP75_2 灭火器开关
0300401

Pin No	Color	Functions	Re- marks
1	L-GN/RD	电源	
2	YE/BK	接地	

Pin No	Color	Functions	Re- marks
1	BK/RD	SIG_1	
2	WH/GY	SIG_2	

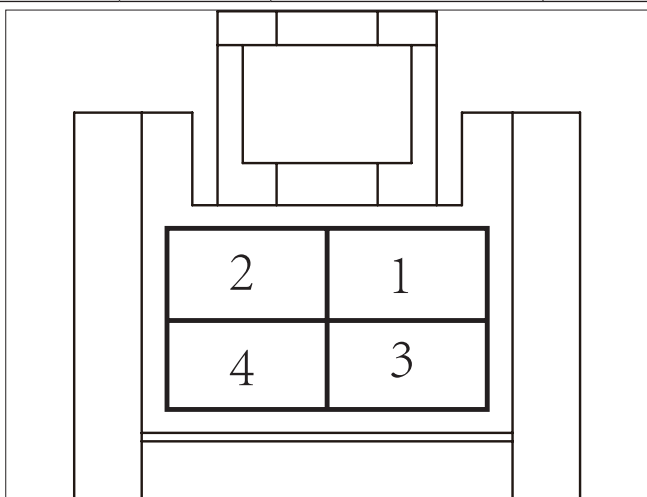

IP75_1 灭火器开关
DJ7041A-2.8-11

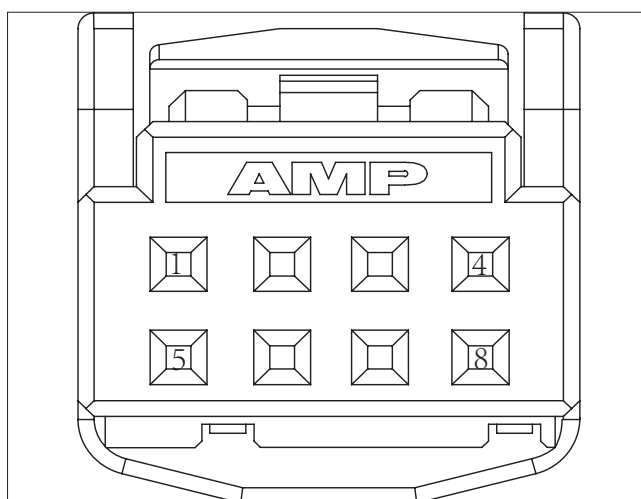

IP77 电子通讯开关
1376352-1

Pin No	Color	Functions	Re- marks
1	RD/YE	电源	

Pin No	Color	Functions	Re- marks
1	WH	BL+	
2	BK	BL-	
3	OG/VT	indicator+	
4	D-BU	indicator-	
5	-	-	
6	WH/D-BU	SWITCH SIG	
7	BARE	屏蔽线	
8	-	-	

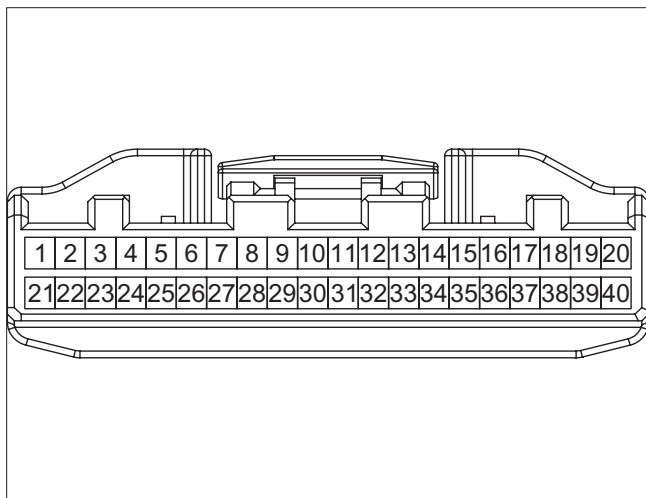

IP78 T-BOX
2325415-1

Pin No	Color	Functions	Re- marks
1	VT	ACC	
2	-	-	
3	-	-	
4	-	-	
5	BARE	MIC Out -	
6	WH	MIC In +	
7	-	-	
8	-	-	
9	BK/VT	eCall Speaker +	
10	BARE	屏蔽线	
11	-	-	
12	D-BU	LED-	

Pin No	Color	Functions	Re- marks
13	-	-	
14	-	-	
15	-	-	
16	-	-	
17	-	-	
18	-	-	
19	D-BU/VT	CAN_H	
20	RD/BK	电源	
21	-	-	
22	-	-	
23	-	-	
24	-	-	
25	WH	MIC output to FICM	
26	BARE	屏蔽线	
27	-	-	
28	-	-	
29	WH/VT	eCall Speaker -	
30	WH/D-BU	SWITCH OUT	
31	-	-	
32	YE	MUTE	
33	-	-	
34	OG/VT	LED+	
35	-	-	
36	-	-	
37	-	-	
38	-	-	
39	D-BU/GY	CAN_L	
40	BK	接地	

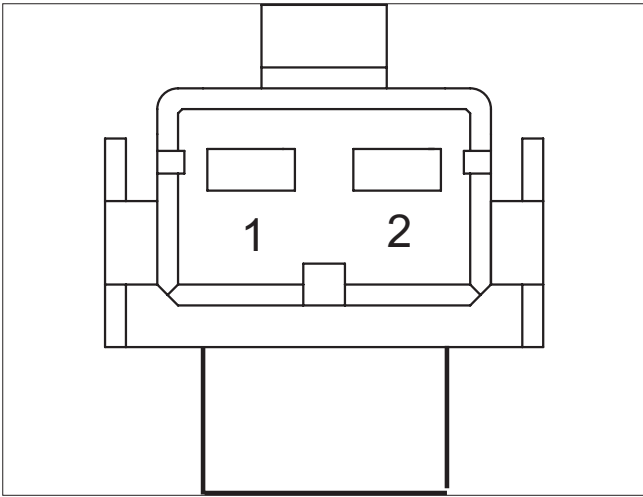

IP79 远程通讯模块
CONN 2 F 070 WHT

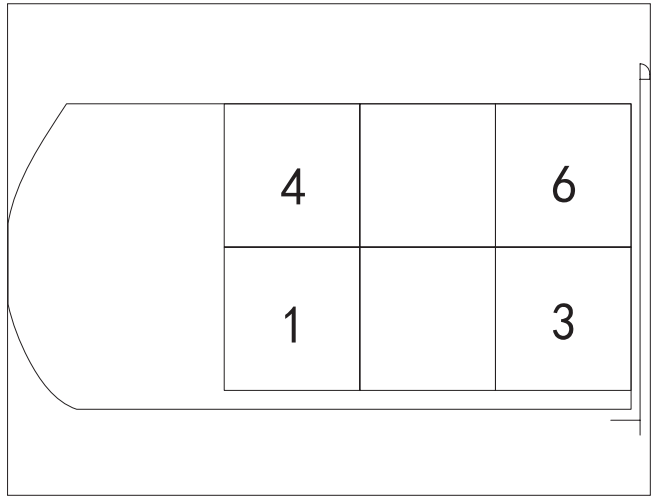

IP27 危险报警开关
CONN 6 F 0.64 MQS WHT

Pin No	Color	Functions	Re- marks
1	BK/VT	eCall Speaker +	
2	WH/VT	eCall Speaker -	

Pin No	Color	Functions	Re- marks
1	BK	LED-	
2	WH	HOME SIG1	
3	WH	LED+	
4	BK	接地	
5	YE	HAZARD SW SIG	
6	BK	HOME SIG2	

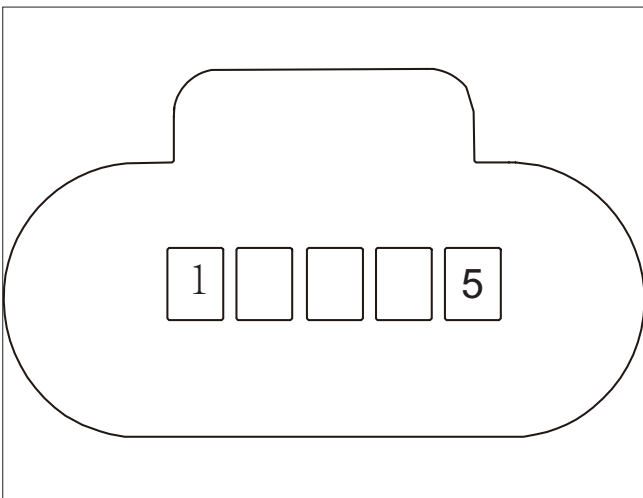

IP1000 前温度传感器
0450905

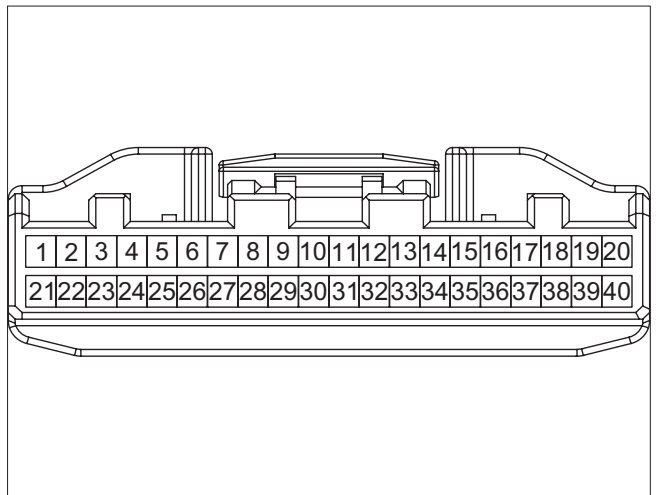

IP38 空调控制面板
CONN 40 F 064 BLK

Pin No	Color	Functions	Re- marks
1	RD/D-BU	电源	
2	D-GN/GY	LIN	
3	BK	接地	
4	-	-	
5	-	-	

Pin No	Color	Functions	Re- marks
1	RD/D-BU	电源	
2	RD	电源	

Pin No	Color	Functions	Re- marks
3	-	-	
4	VT	R-PRESS_SENS	
5	-	-	
6	D-BU/YE	CAN_L	
7	D-BU/RD	CAN_H	
8	-	-	
9	OG	F_BLOWER_CTRL	
10	L-BU	R-DEF-REQUEST	
11	D-GN	F_BLOWER_FB-	
12	D-BU	F_BLOWER_RELAY_CTRL	
13	VT/D-GN	MOTOR_TEMP+	
14	D-BU	MOTOR_TEMP-	
15	WH	MOTOR_MODE-	
16	GY	MOTOR_MODE+	
17	VT	MOTOR_R/F+	
18	BN	MOTOR_R/F-	
19	-	-	
20	D-GN/GY		
21	BK	接地	
22	BK/WH	接地	
23	-	-	
24	OG	R-COOL-BLOWER_CTRL	
25	L-GN	R-COOL_BLOWER_RELAY_CTRL	
26	WH	R-COOL-BLOWER_FB-	
27	GY	R-HOT-BLOWER_CTRL	
28	VT/D-GN	R-HOT_BLOWER_RELAY_CTRL	
29	VT/D-GN	R-HOT-BLOWER_FB-	
30	-	-	
31	-	-	

Pin No	Color	Functions	Re- marks
32	GY	TEMP_R_EVAP	
33	OG	TEMP_AMB	
34	BN	F-TEMP_EVAP	
35	L-GN	F_PRESS_SNRS	
36	BN	MOTOR_R/F_FB	
37	D-GN	MOTOR_MODE_FB	
38	VT	MOTOR_TEMP_FB	
39	-	-	
40	YE	5V	

5.1 Power Distribution

5.1.1 Power distribution 1 left rudder

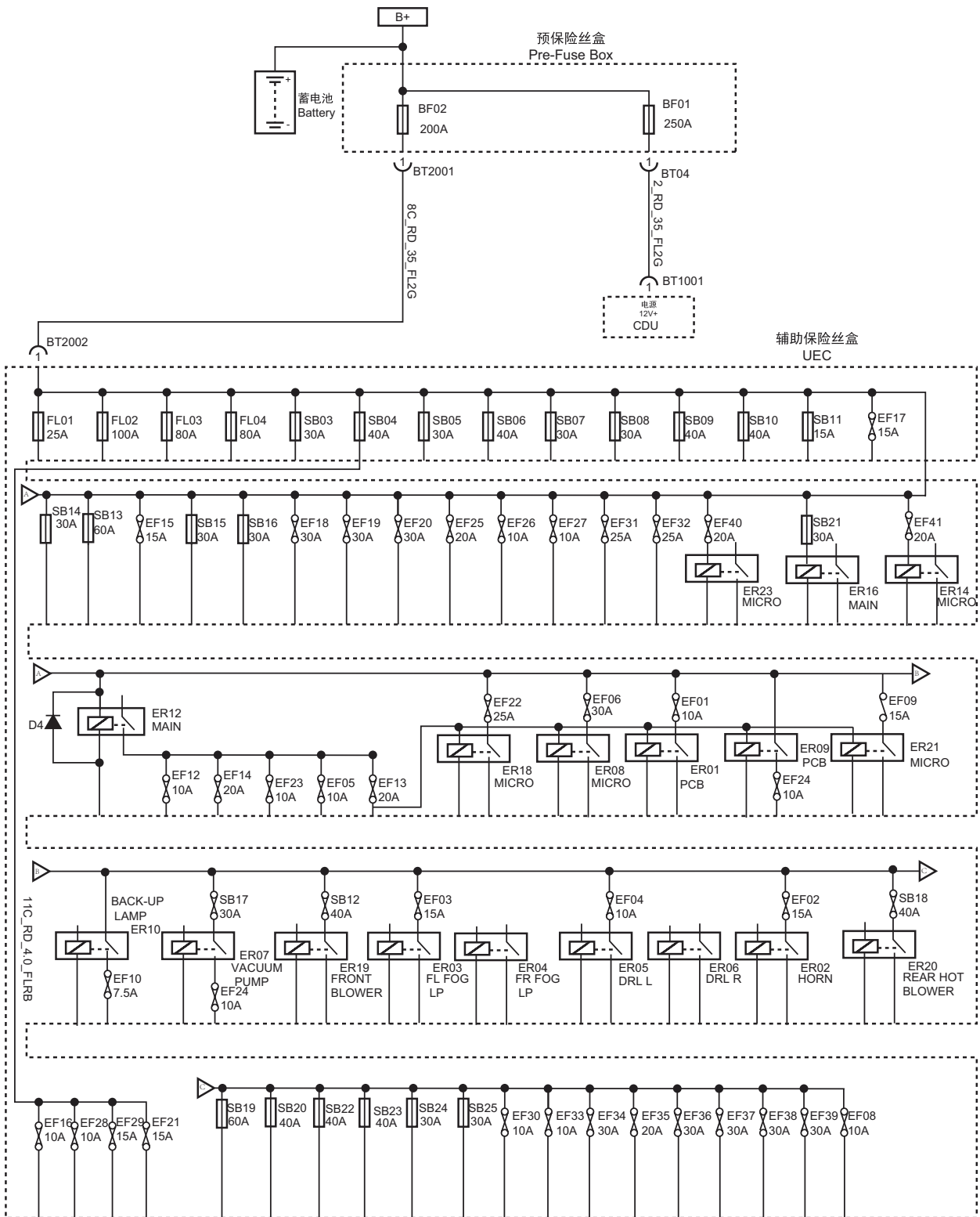

5.1.2 Power distribution 2 left rudder

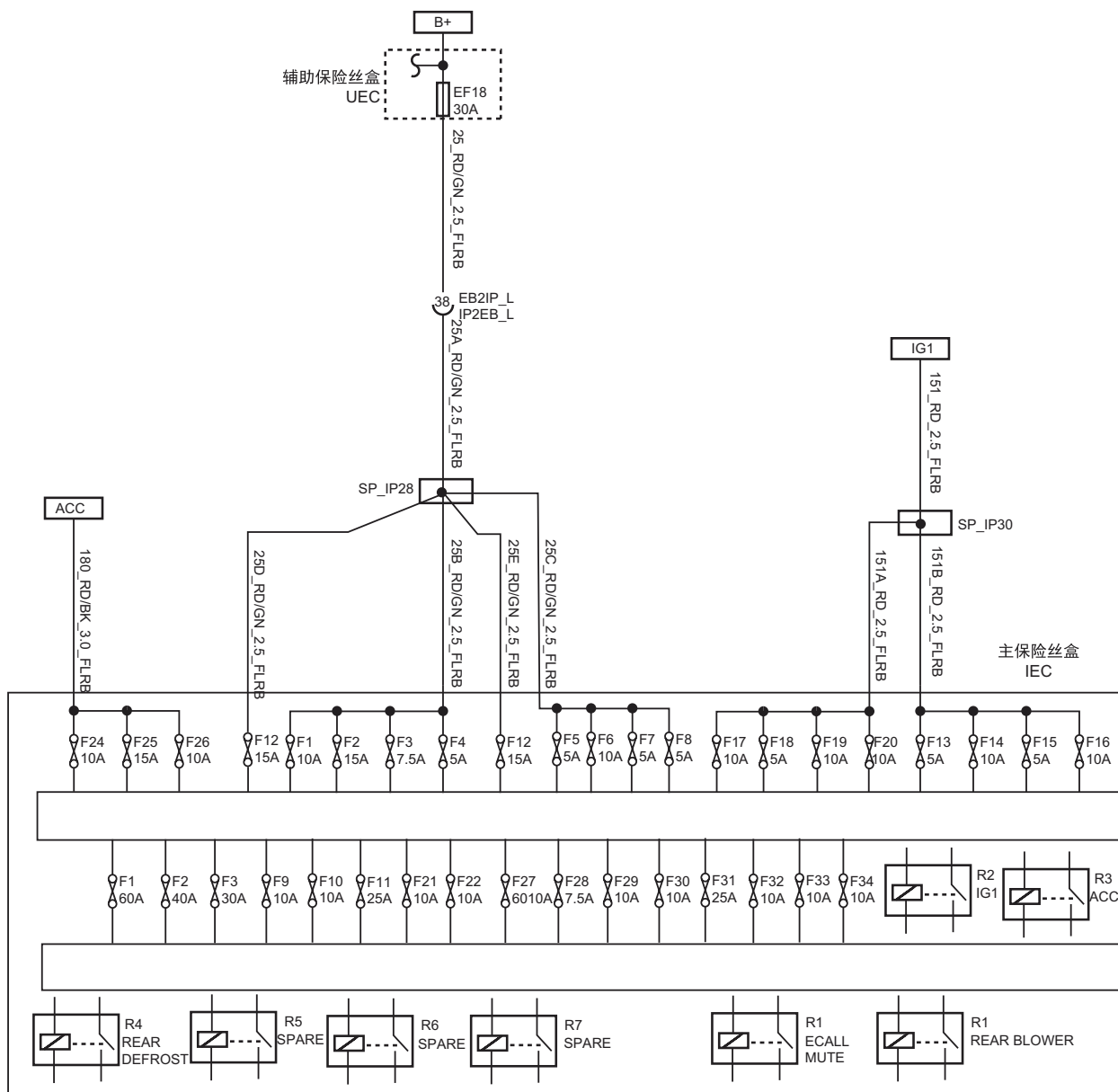

5.1.3 Power distribution 1 right rudder

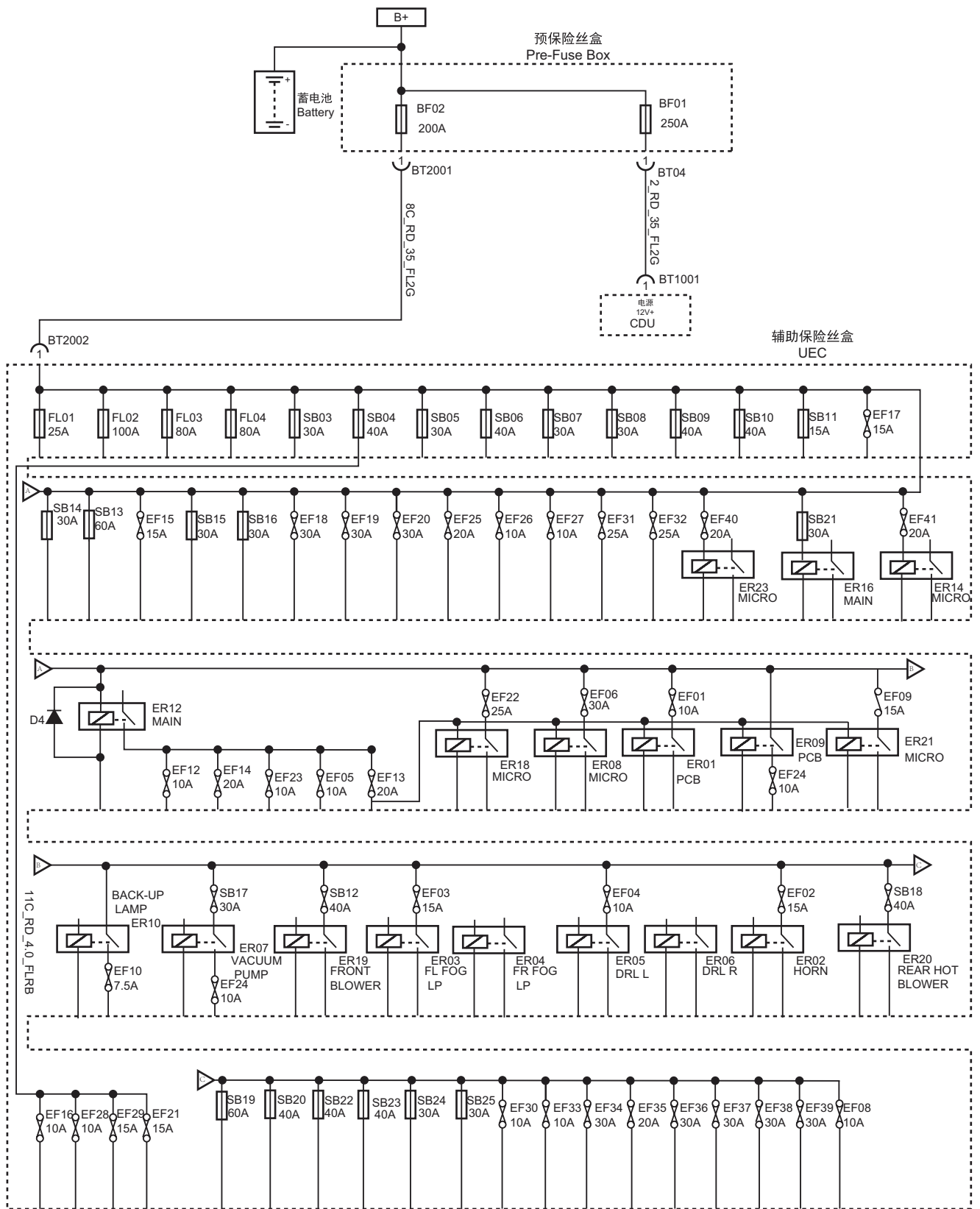

5.1.4 Power distribution 2 right rudder

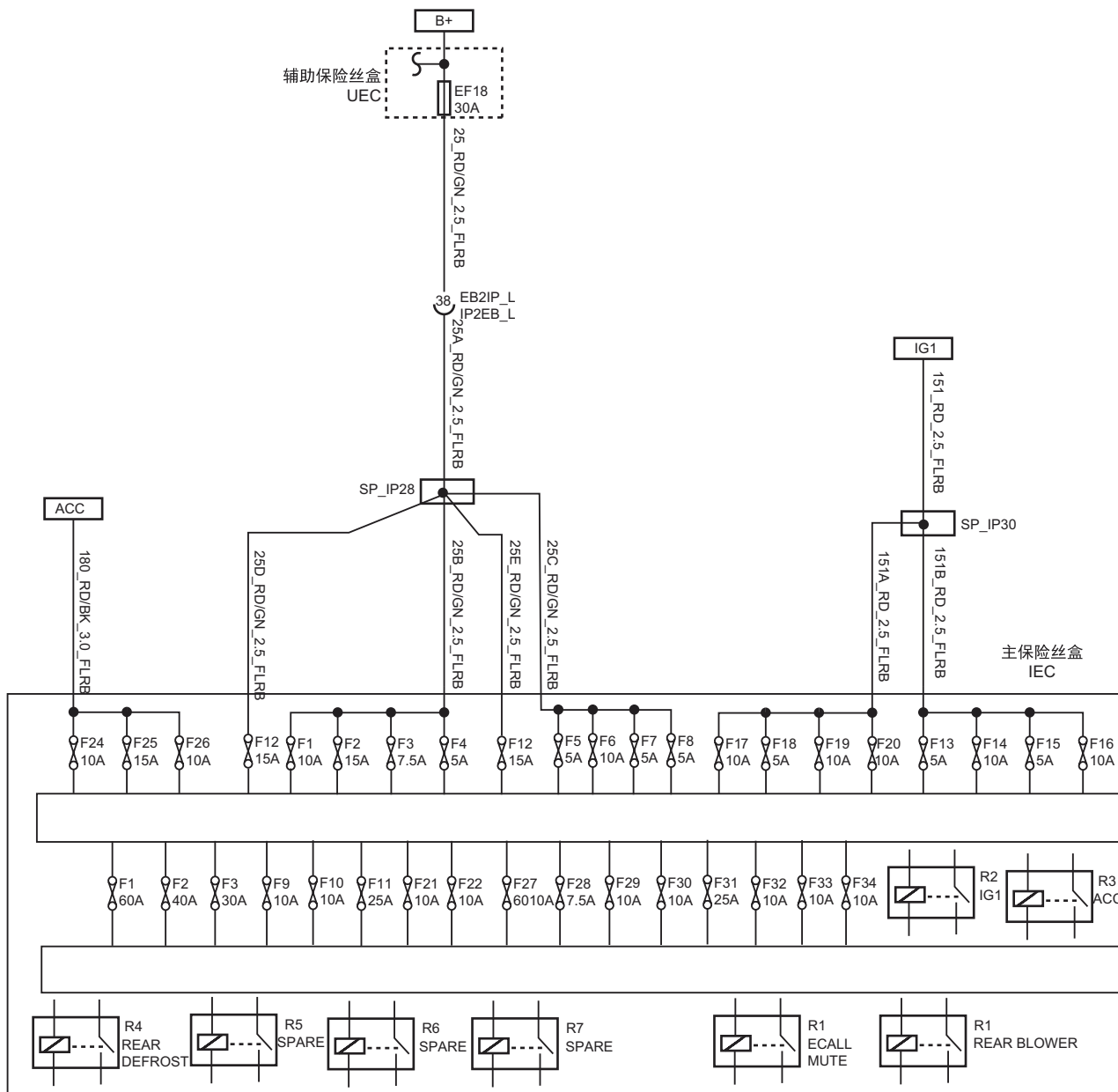

5.2 Power mode System

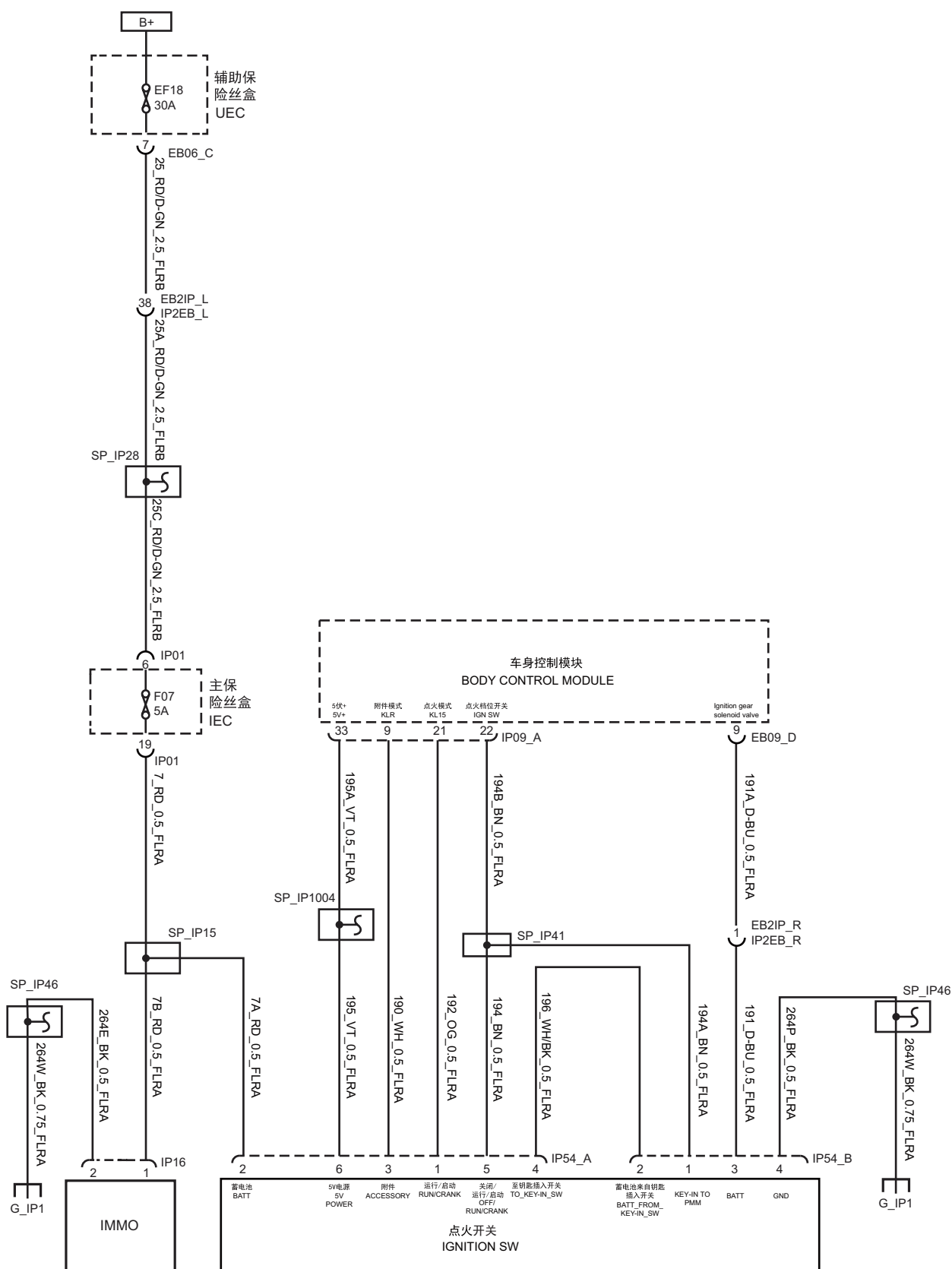

5.3 CDU System

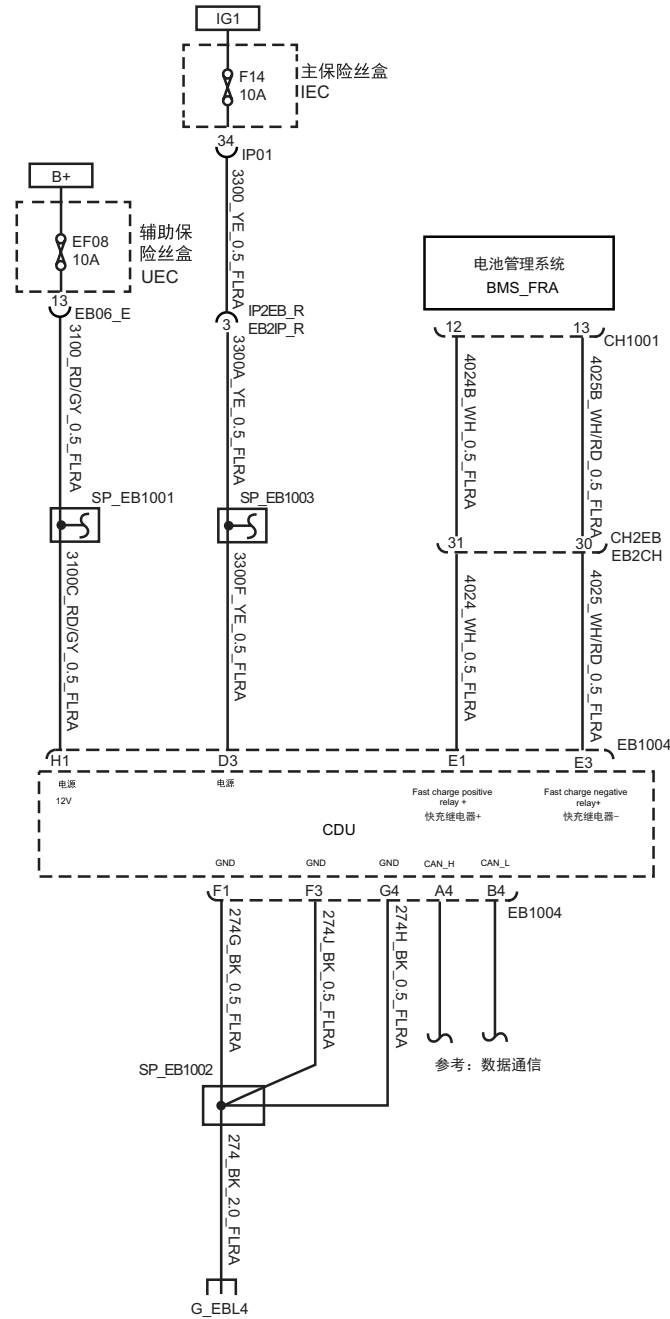

5.5 Electric Power Steering System

5.5.1 Electric Power Steering System -left rudder

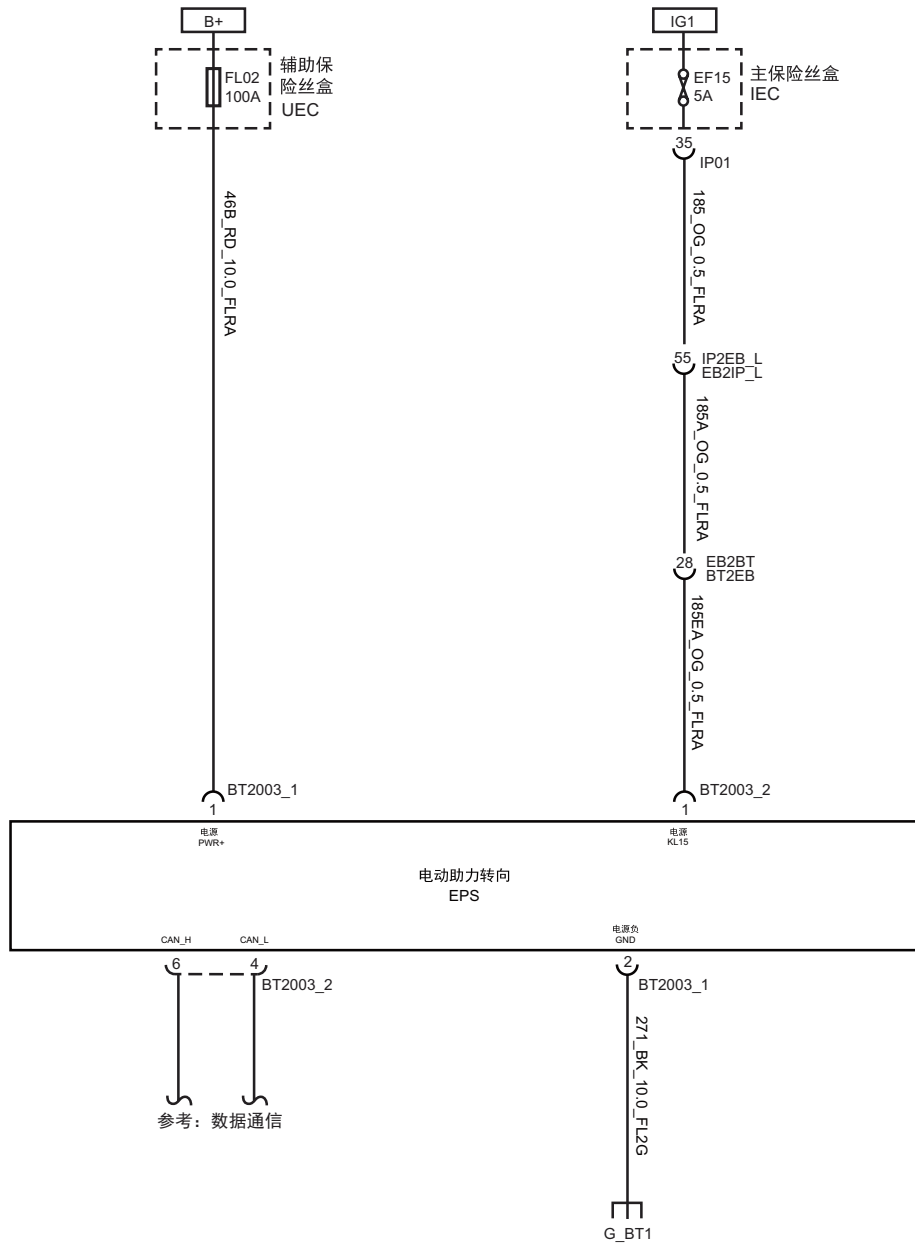

5.5.2 Electric Power Steering System - right rudder

51

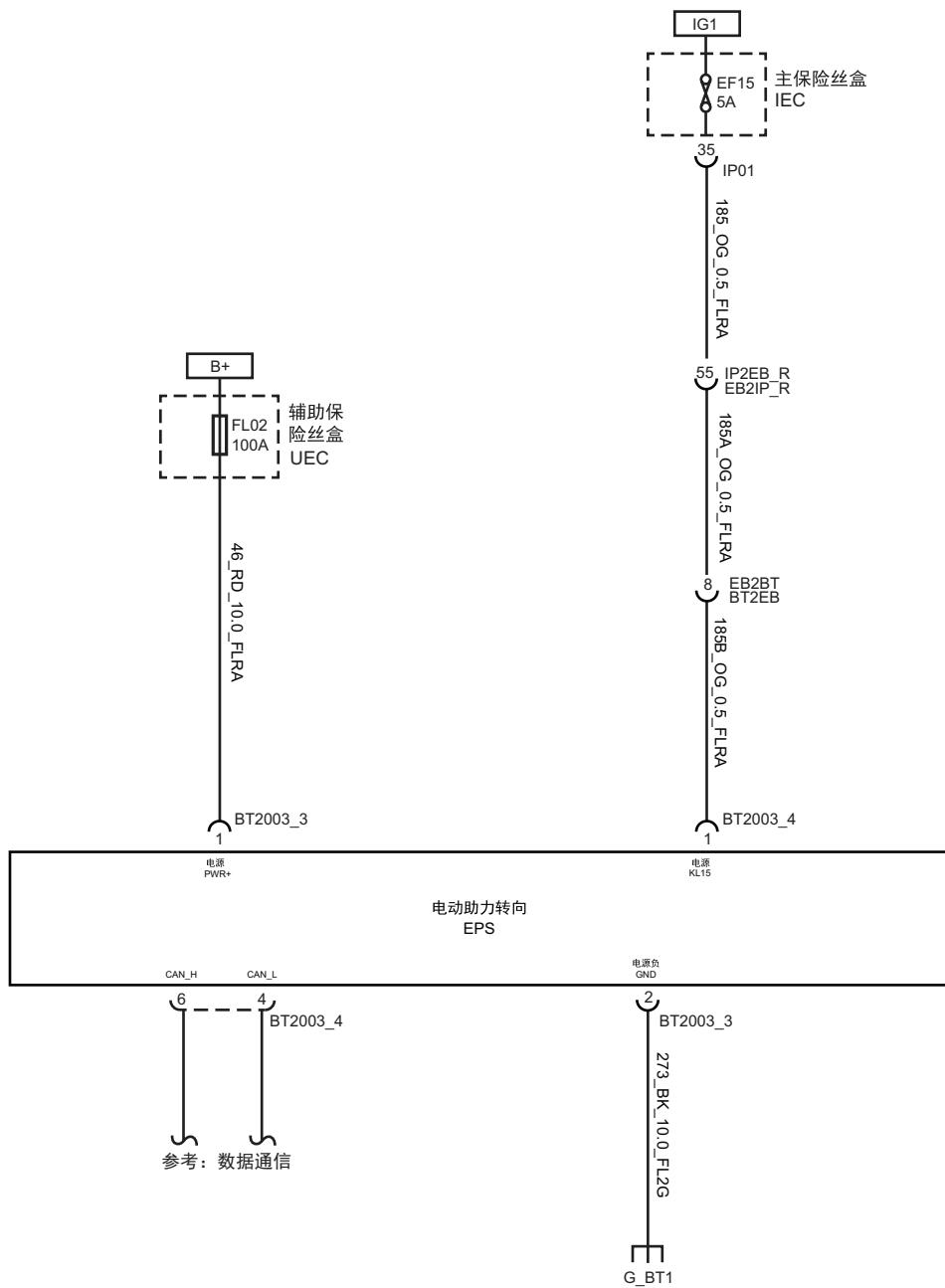

5.6 AIRBAG system

5.6.1 AIRBAG system 1

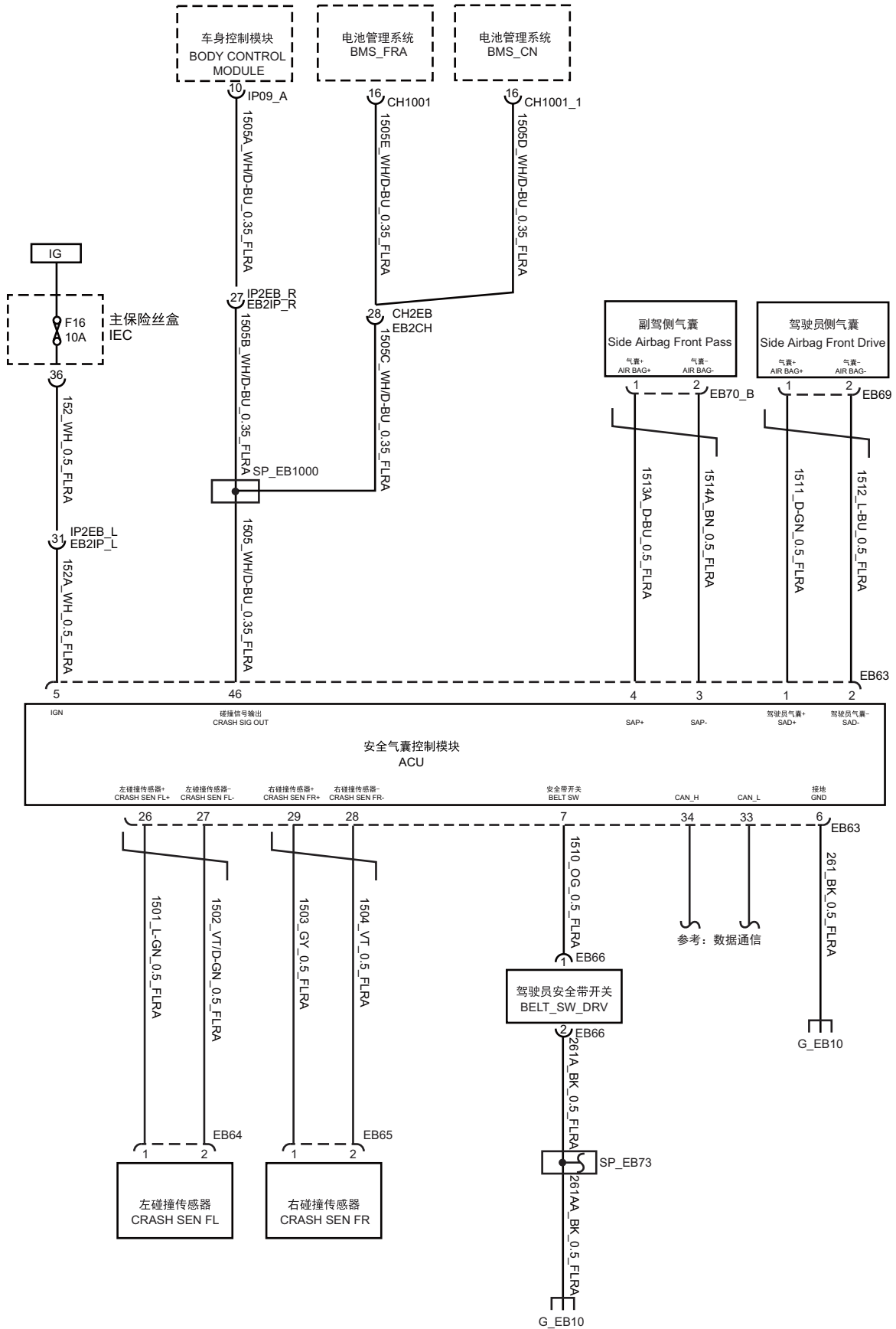

5.6.2 AIRBAG system 2

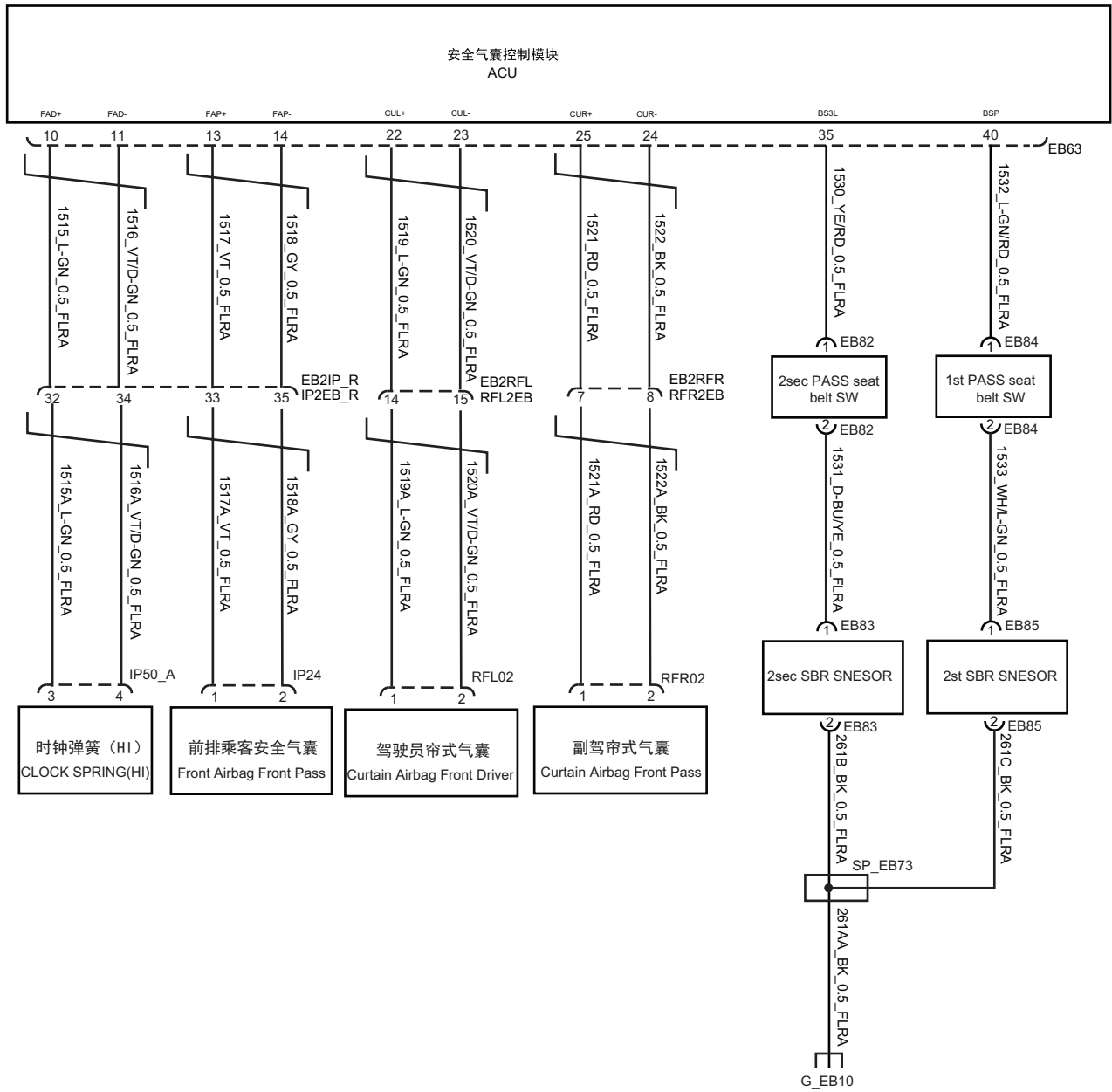

5.7 Air Conditioning System

5.7.1 Air Conditioning System 1-left rudder

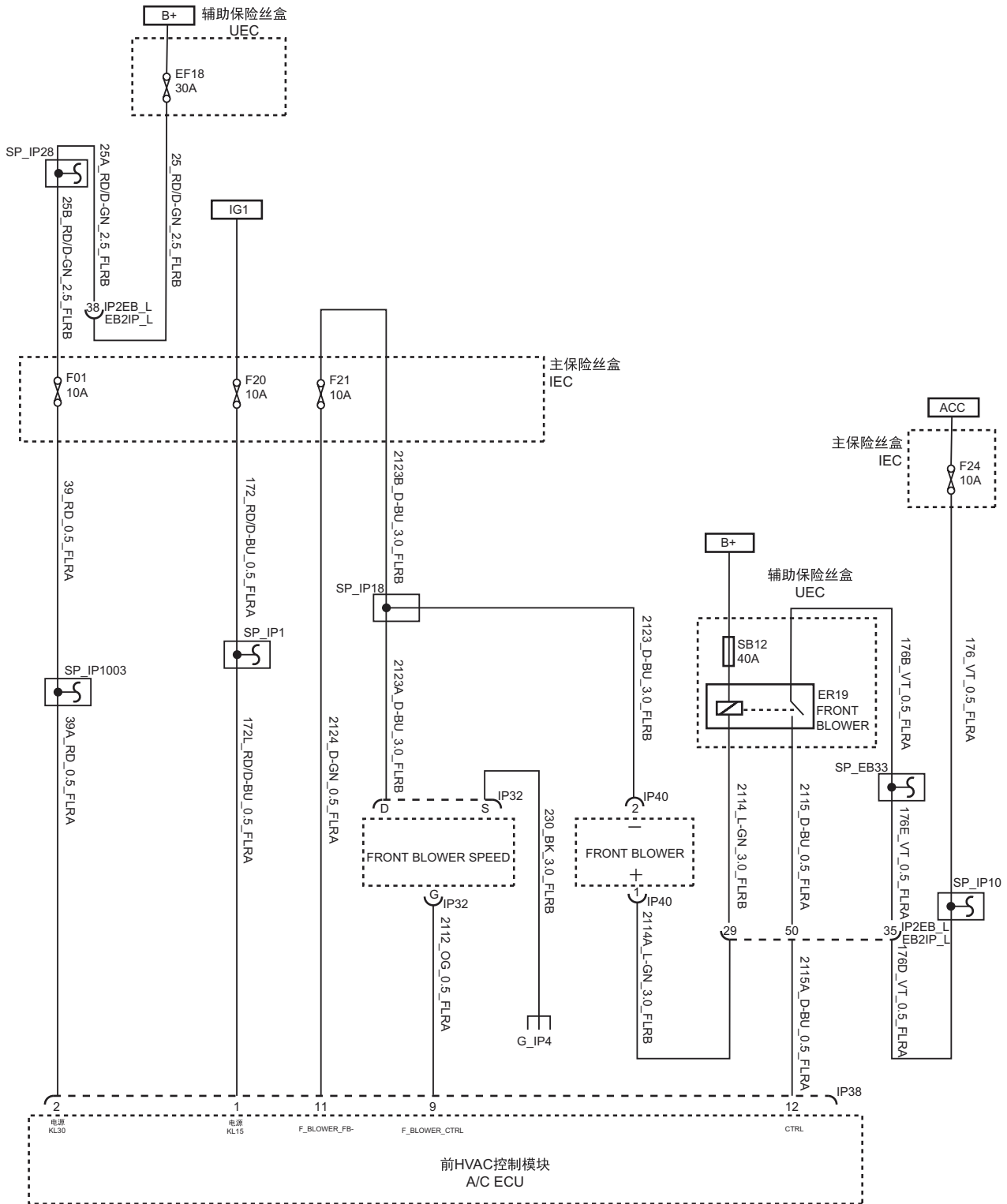

5.7.2 Air Conditioning System 2 -left rudder

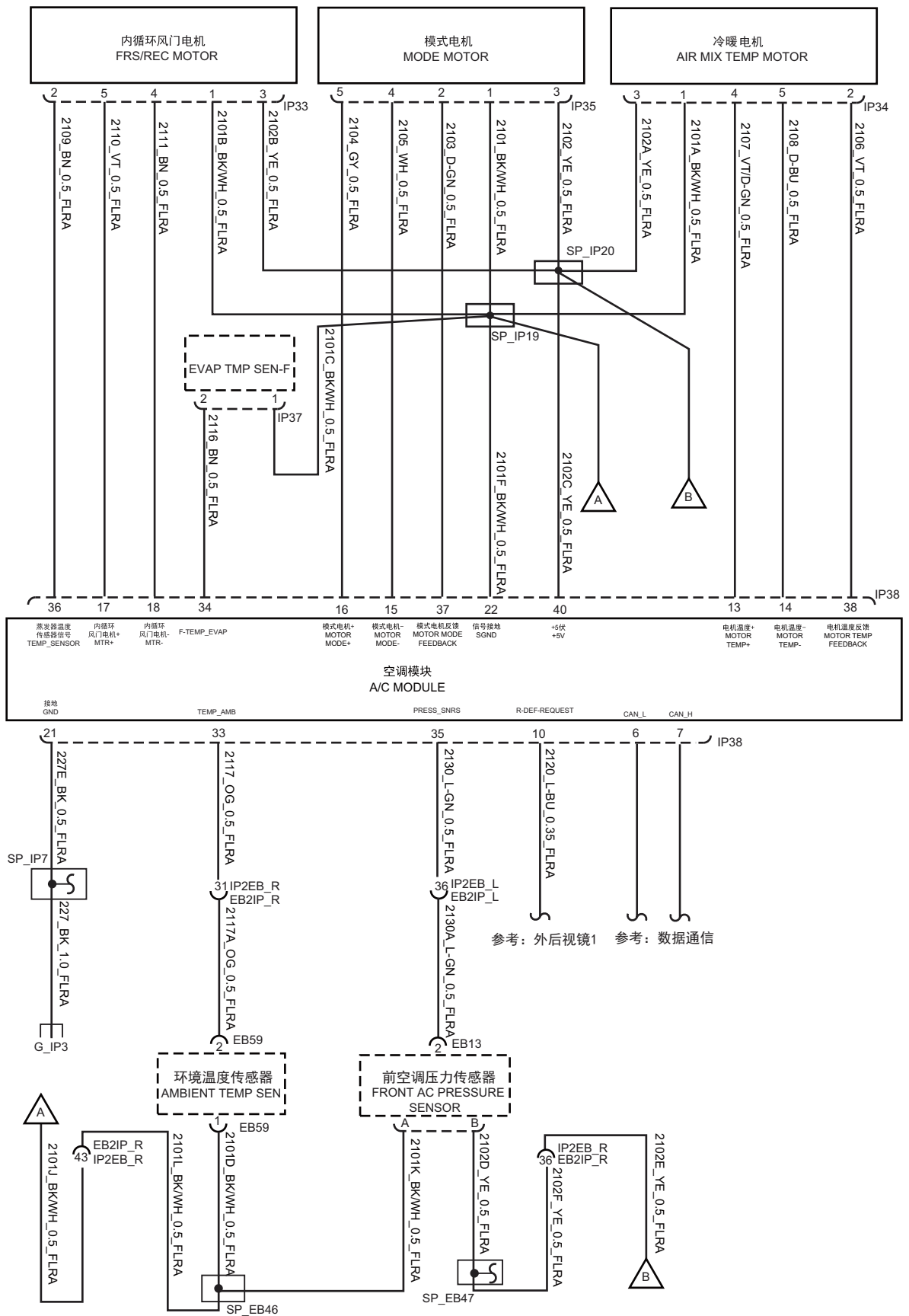

5.7.3 Air Conditioning System 3 -left rudder

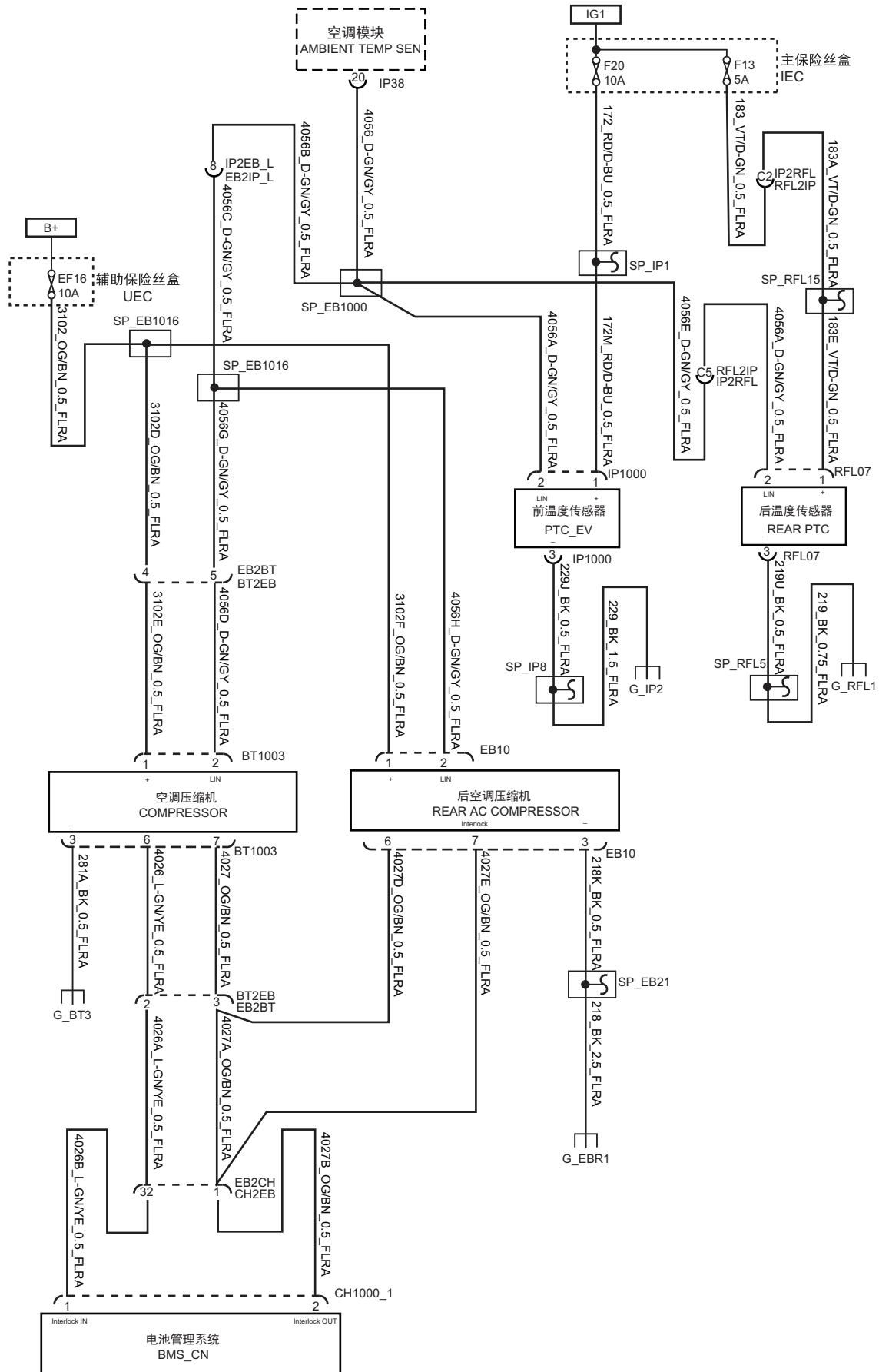

5.7.4 Air Conditioning System 4 -left rudder

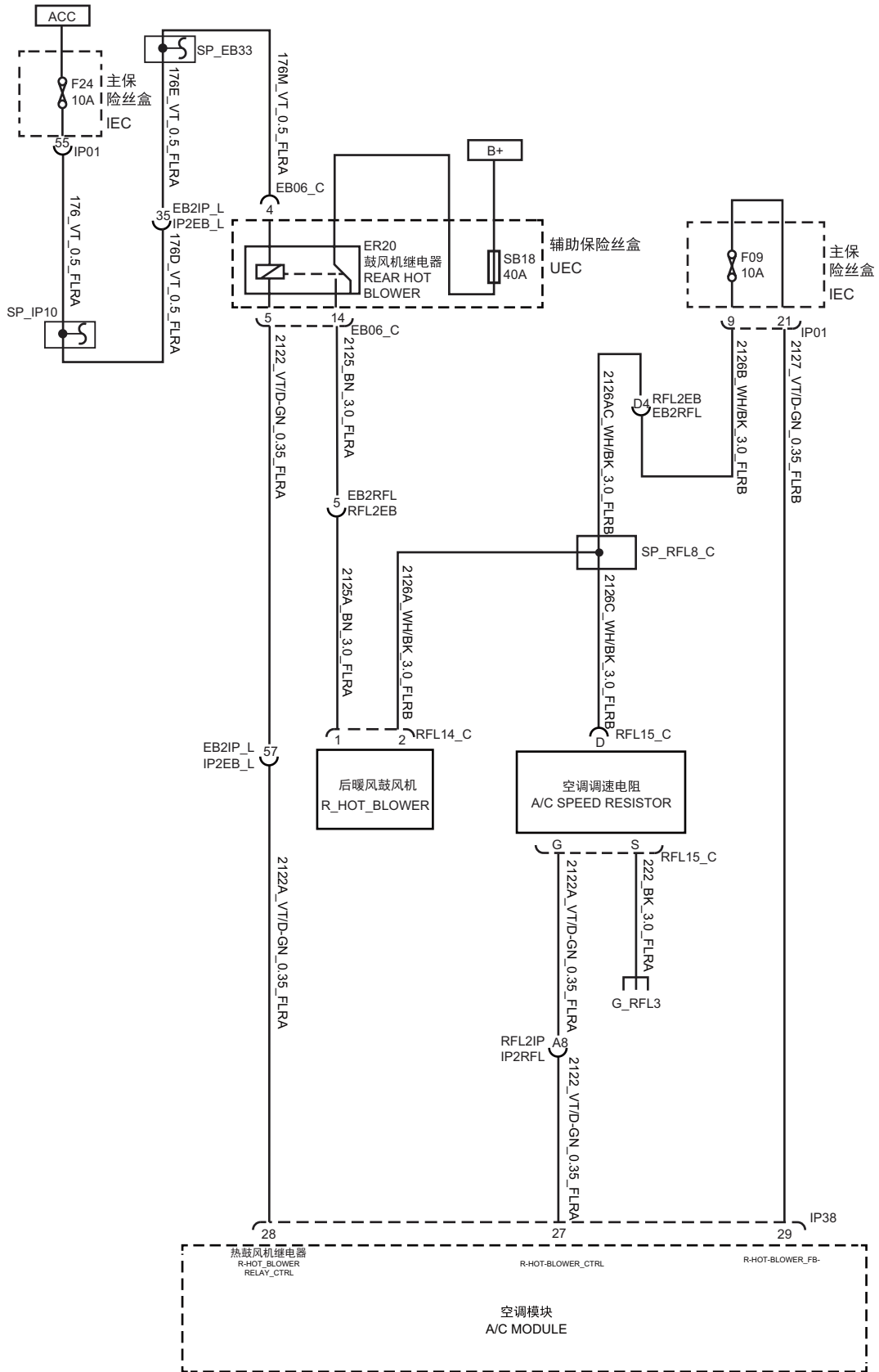

5.7.5 Air Conditioning System 5-left rudder

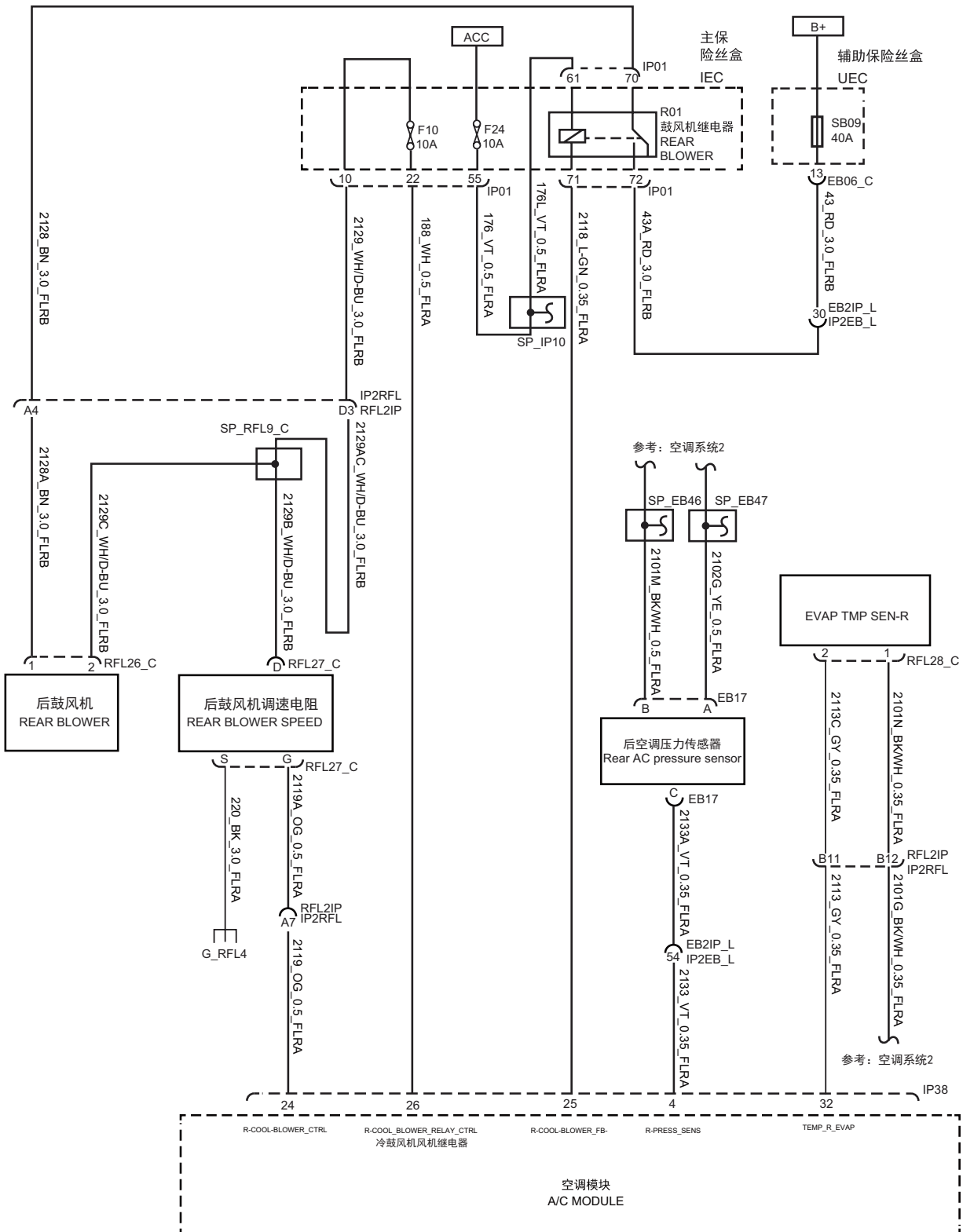

5.7.6 Air Conditioning System 1 - right rudder

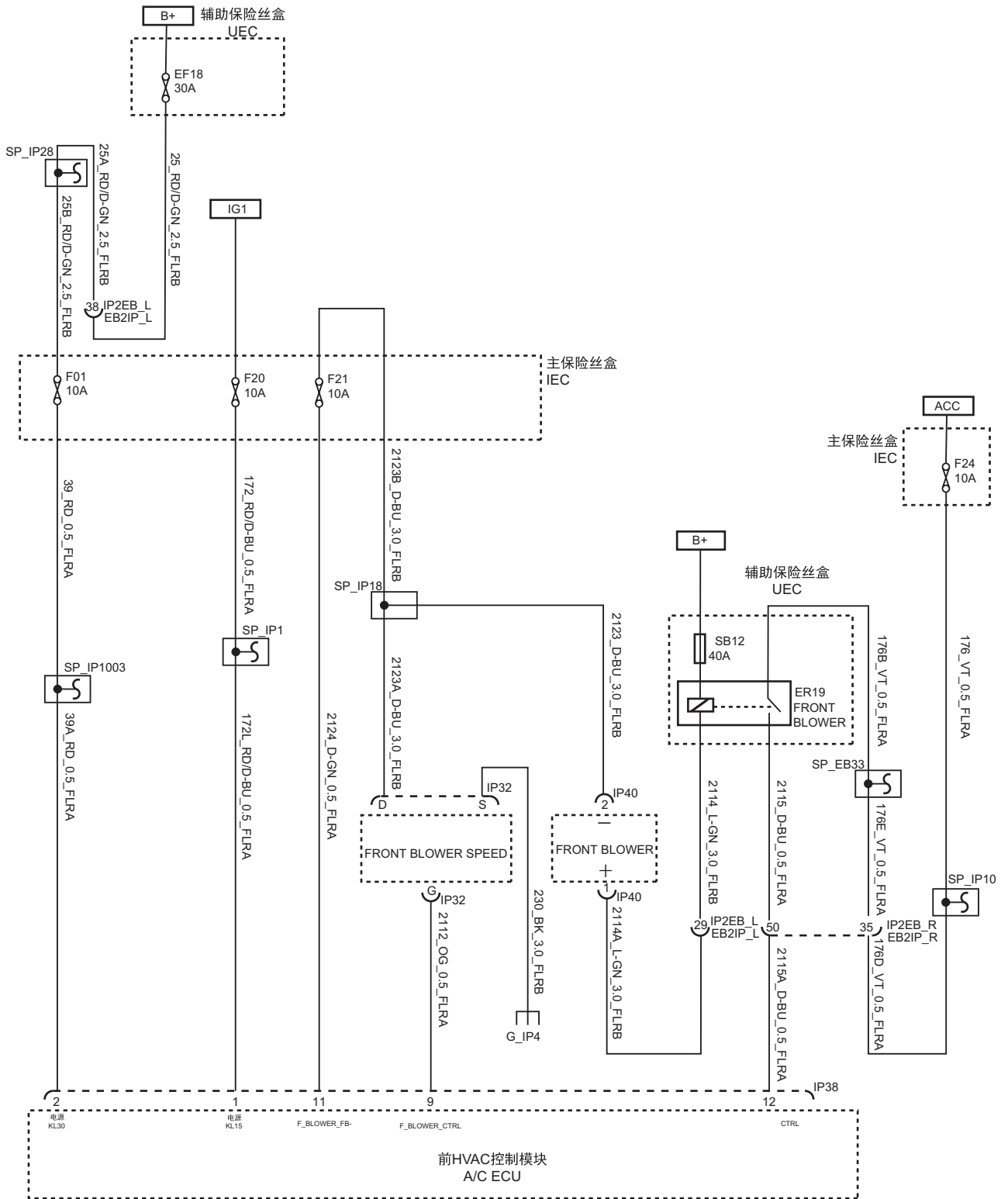

5.7.8 Air Conditioning System 3 - right rudder

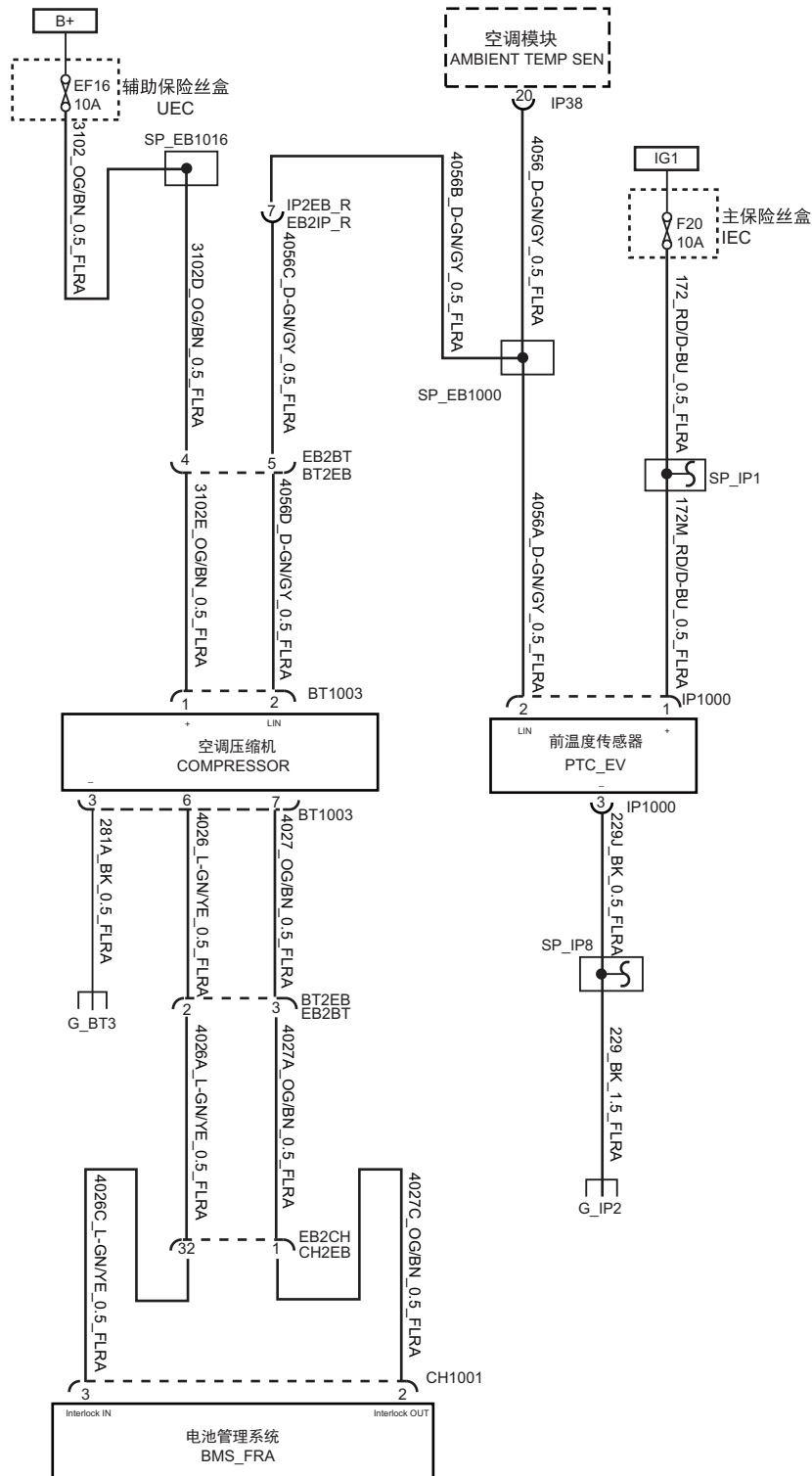

5.8.2 Sound entertainment system (MP3)2-left rudder

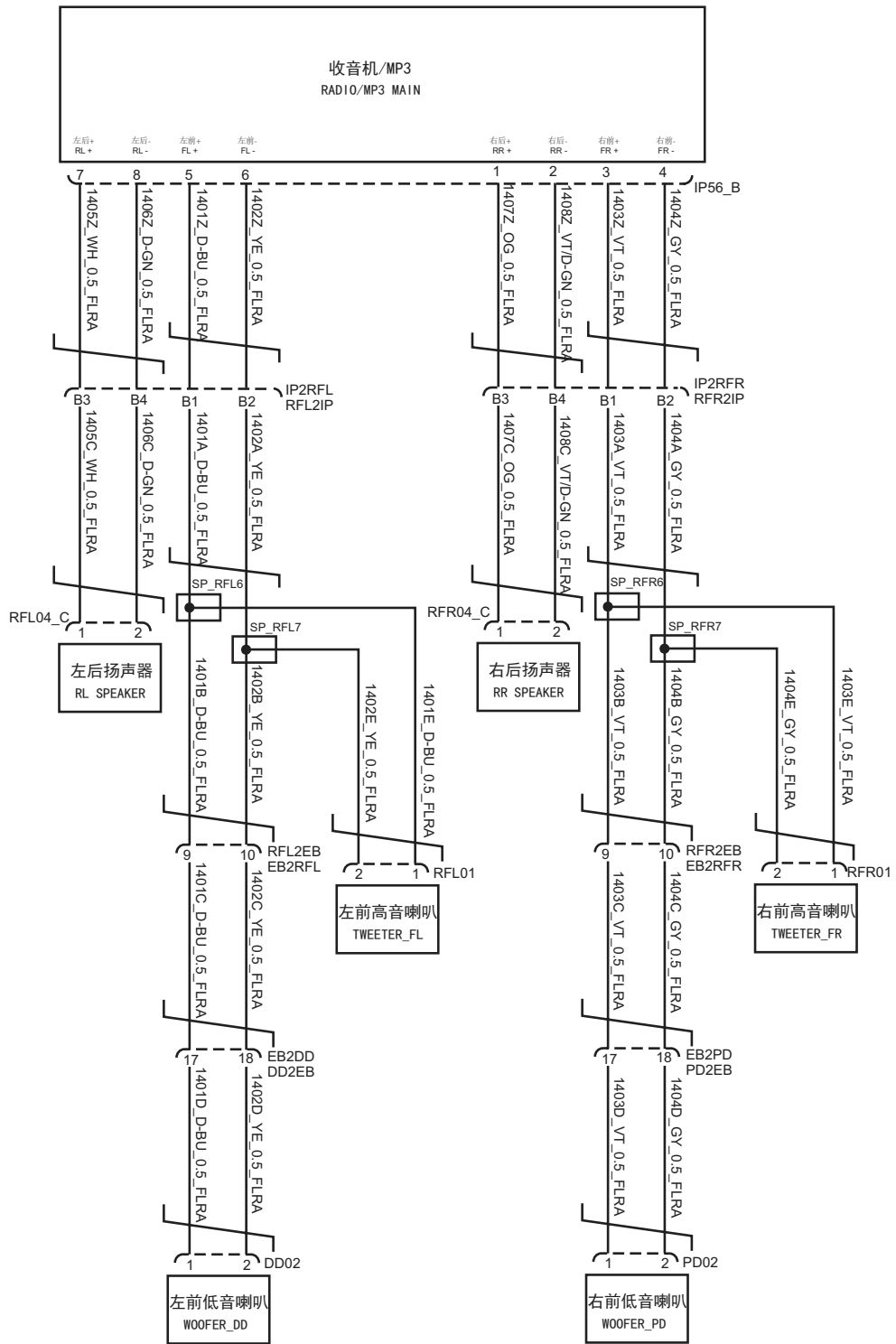

5.8.3 Sound entertainment system (MP5) 1-left rudder

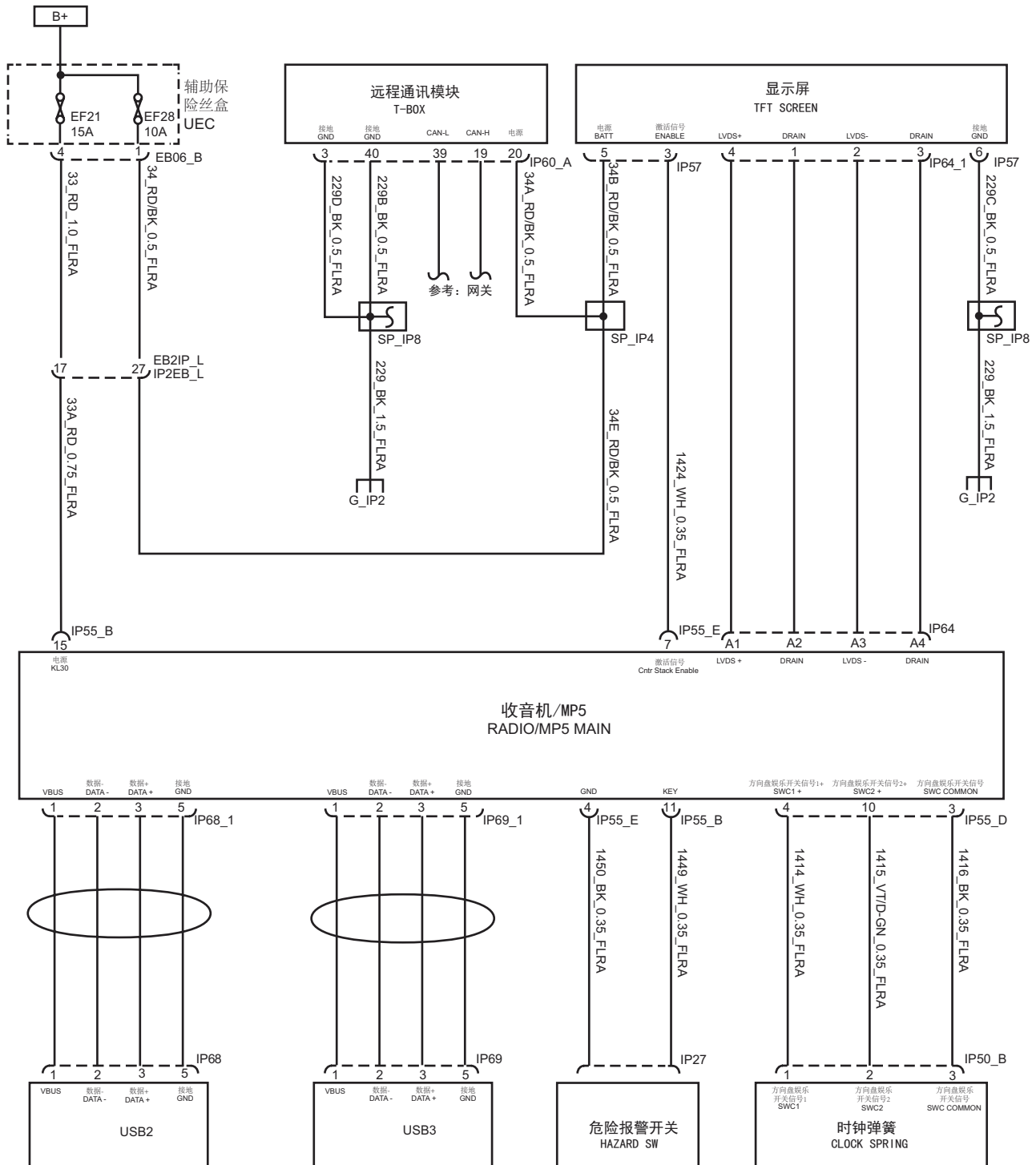

5.8.4 Sound entertainment system (MP5)2-left rudder

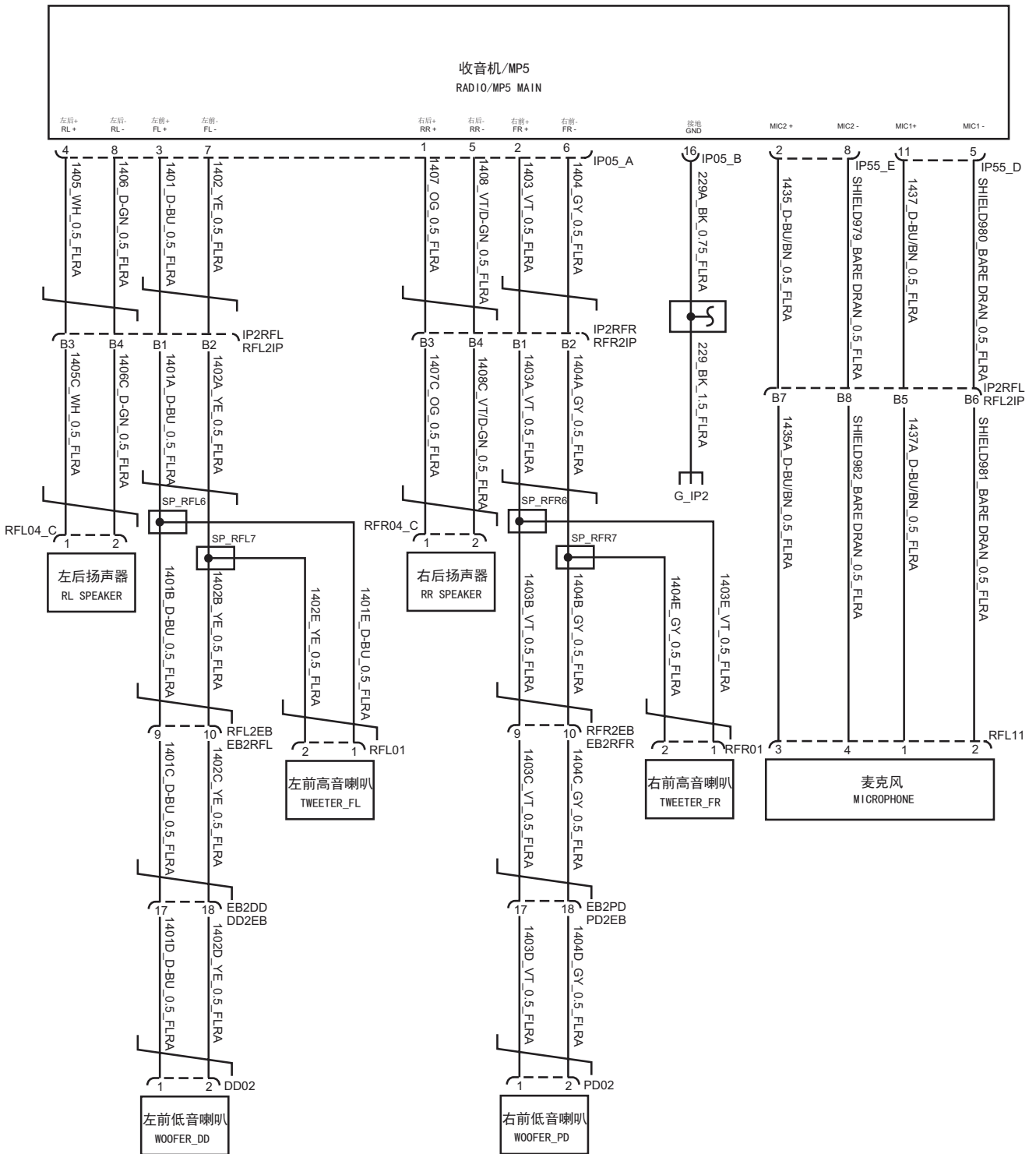

5.8.5 Sound entertainment system (MP5) 3-left rudder

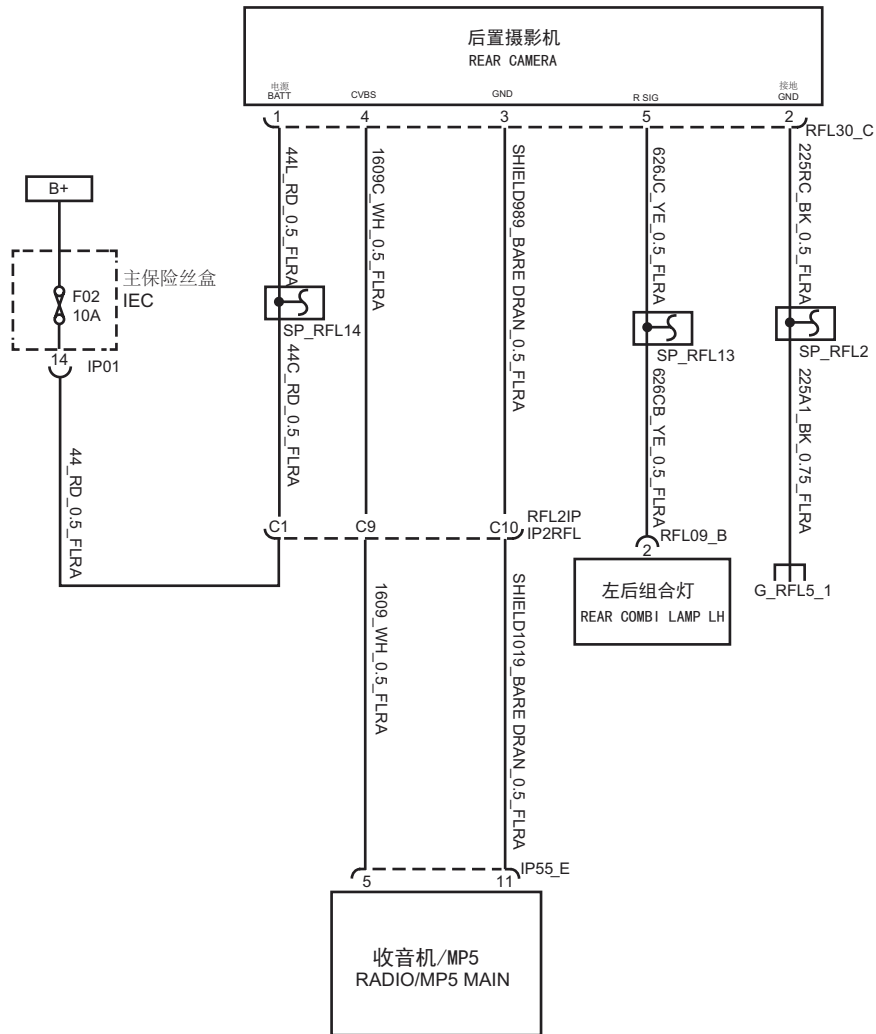

5.8.6 Sound entertainment system (MP5 DR)1-left rudder

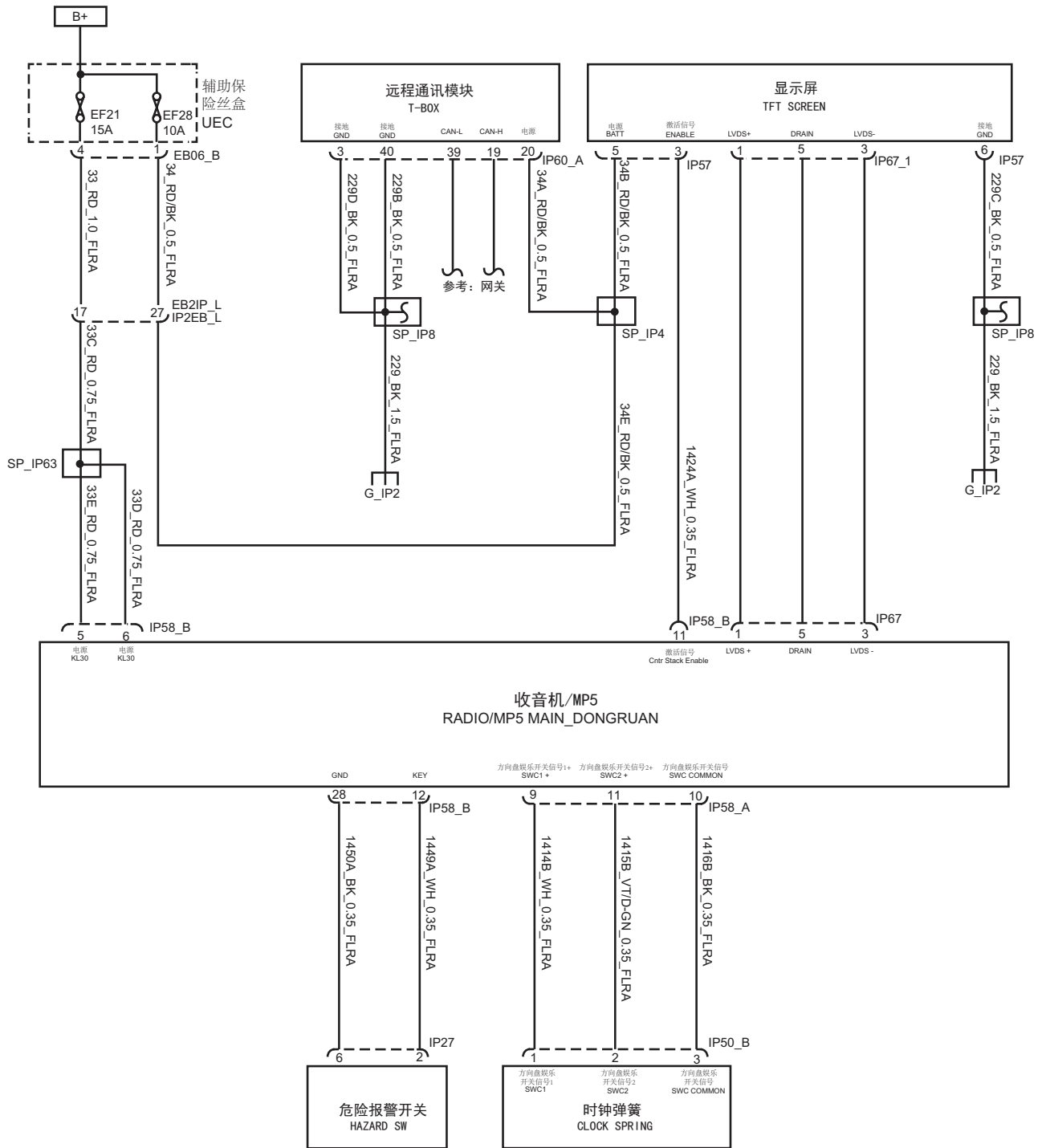

5.8.7 Sound entertainment system (MP5 DR)2-left rudder

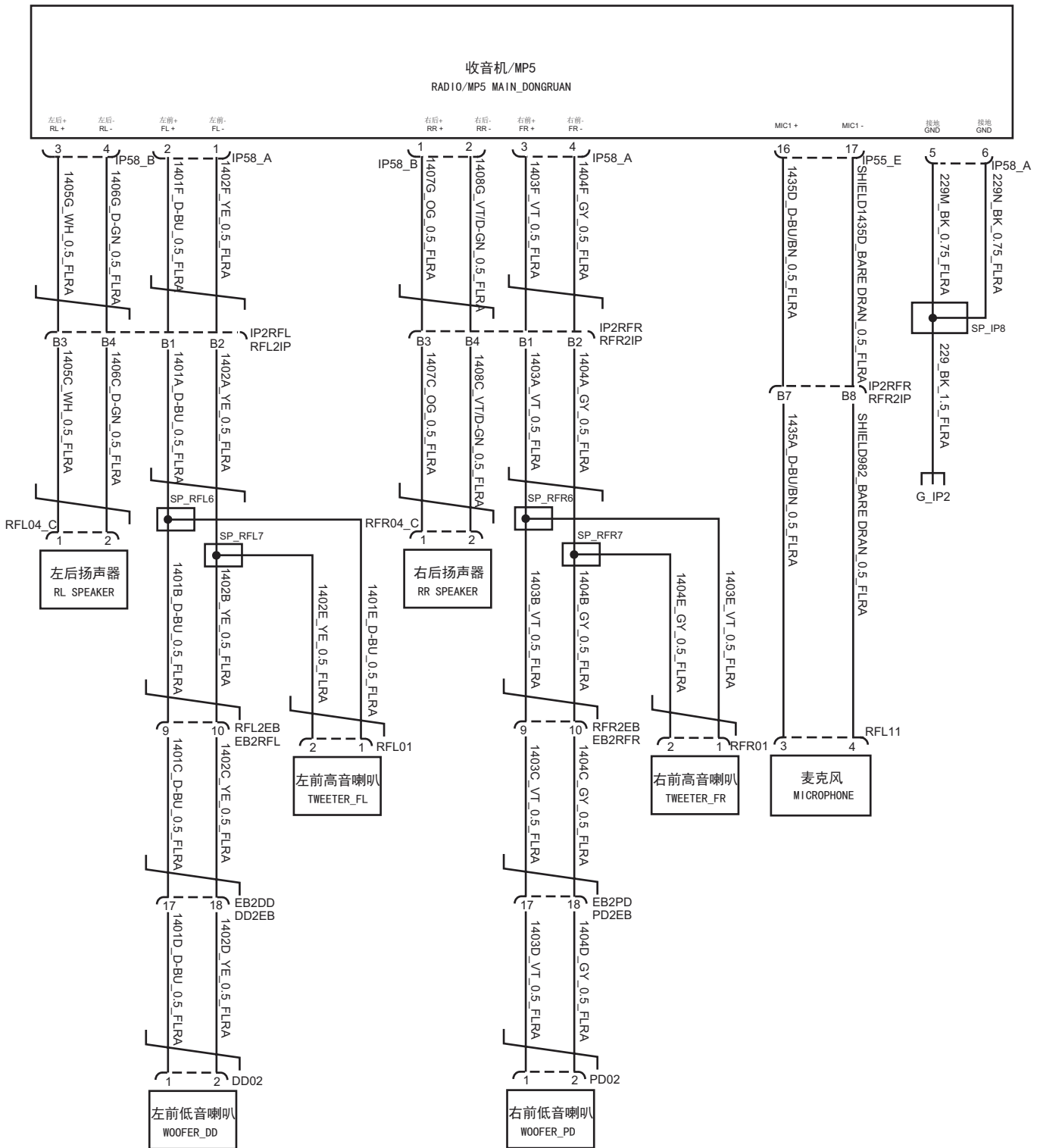

5.8.8 Sound entertainment system (MP5 DR)3-left rudder

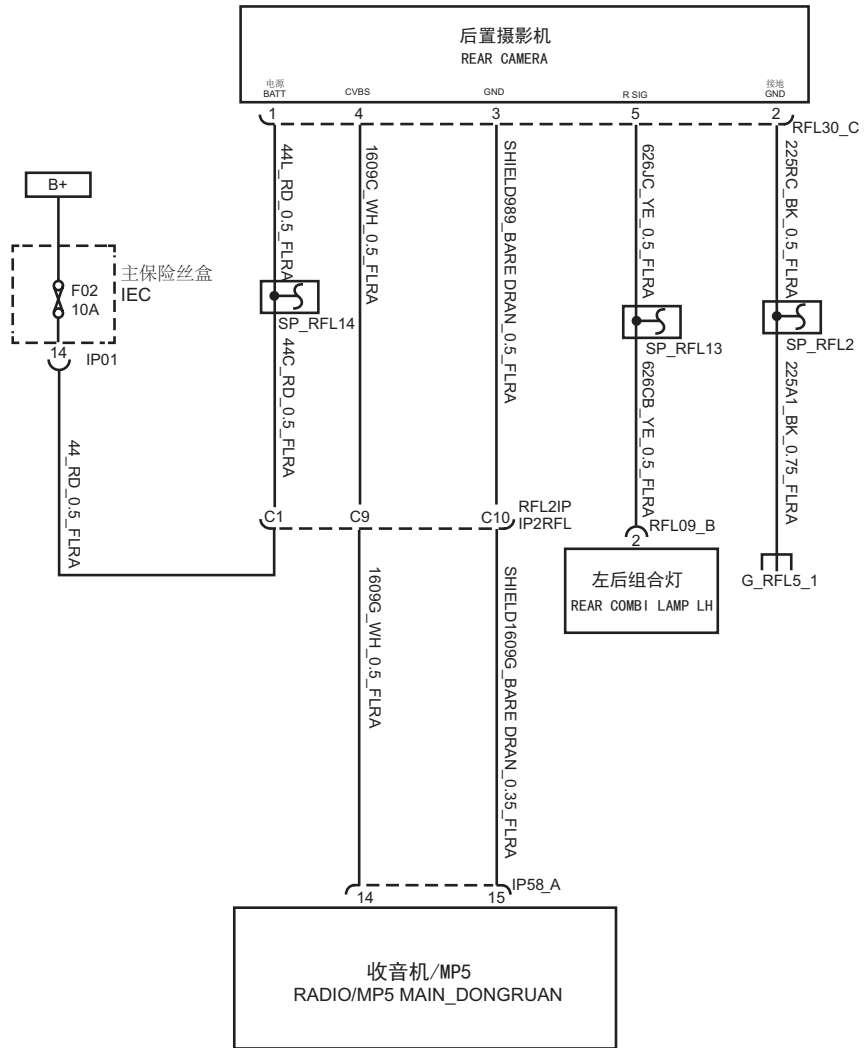

5.8.9 Sound entertainment system (MP3) 1-right rudder

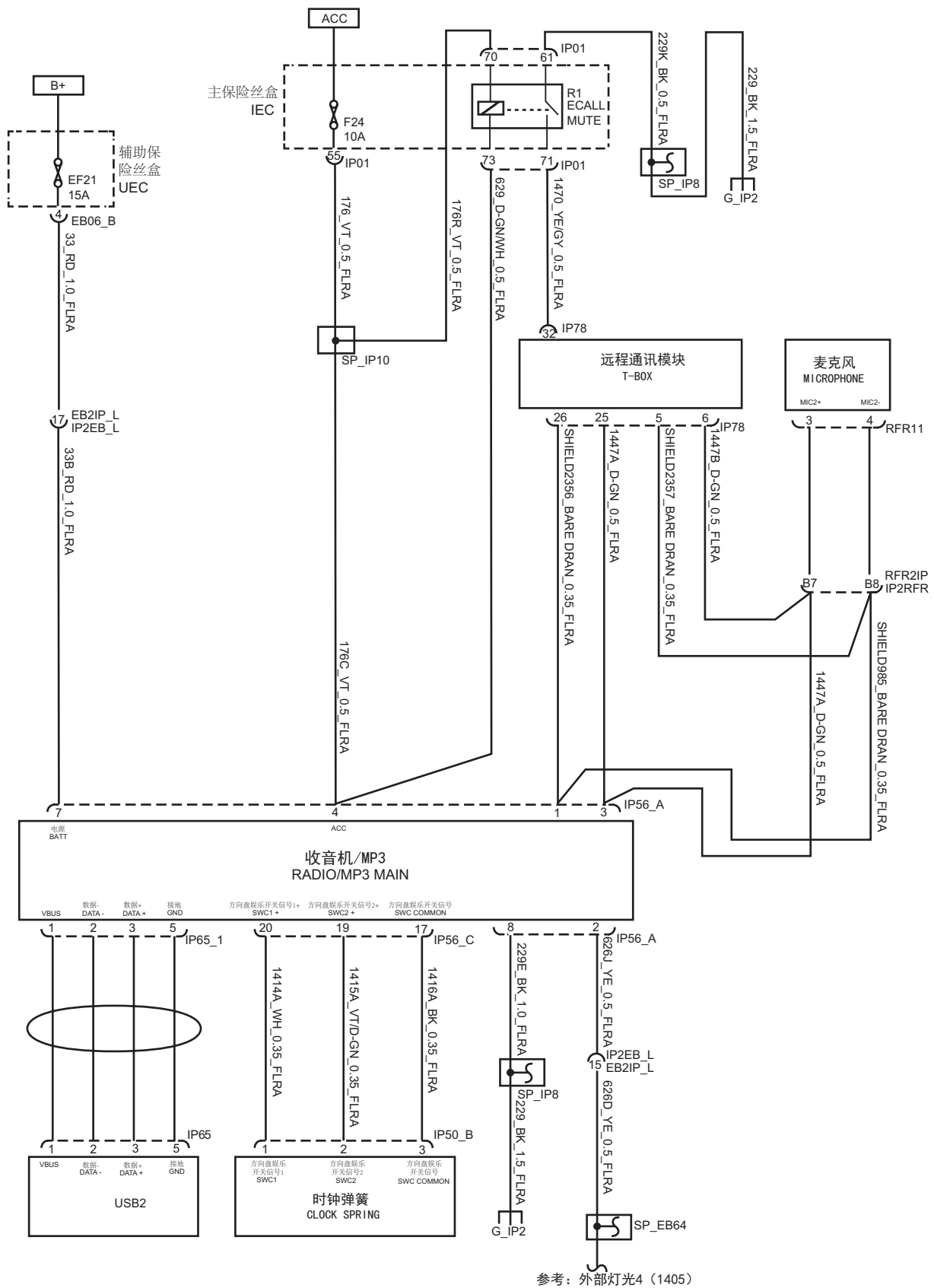

5.8.10 Sound entertainment system (MP3)2-right rudder

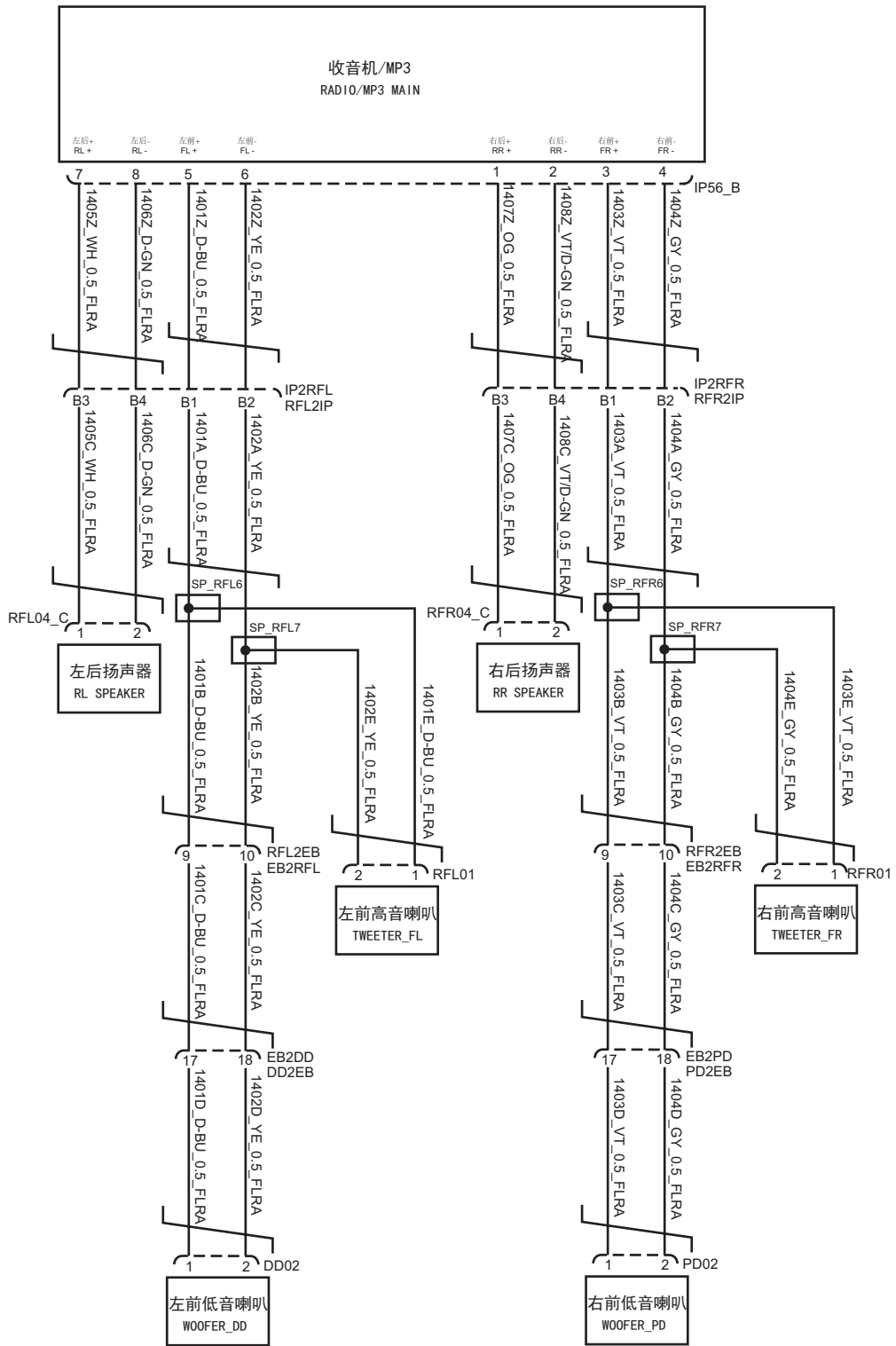

5.8.11 Sound entertainment system (MP5) 1-right rudder

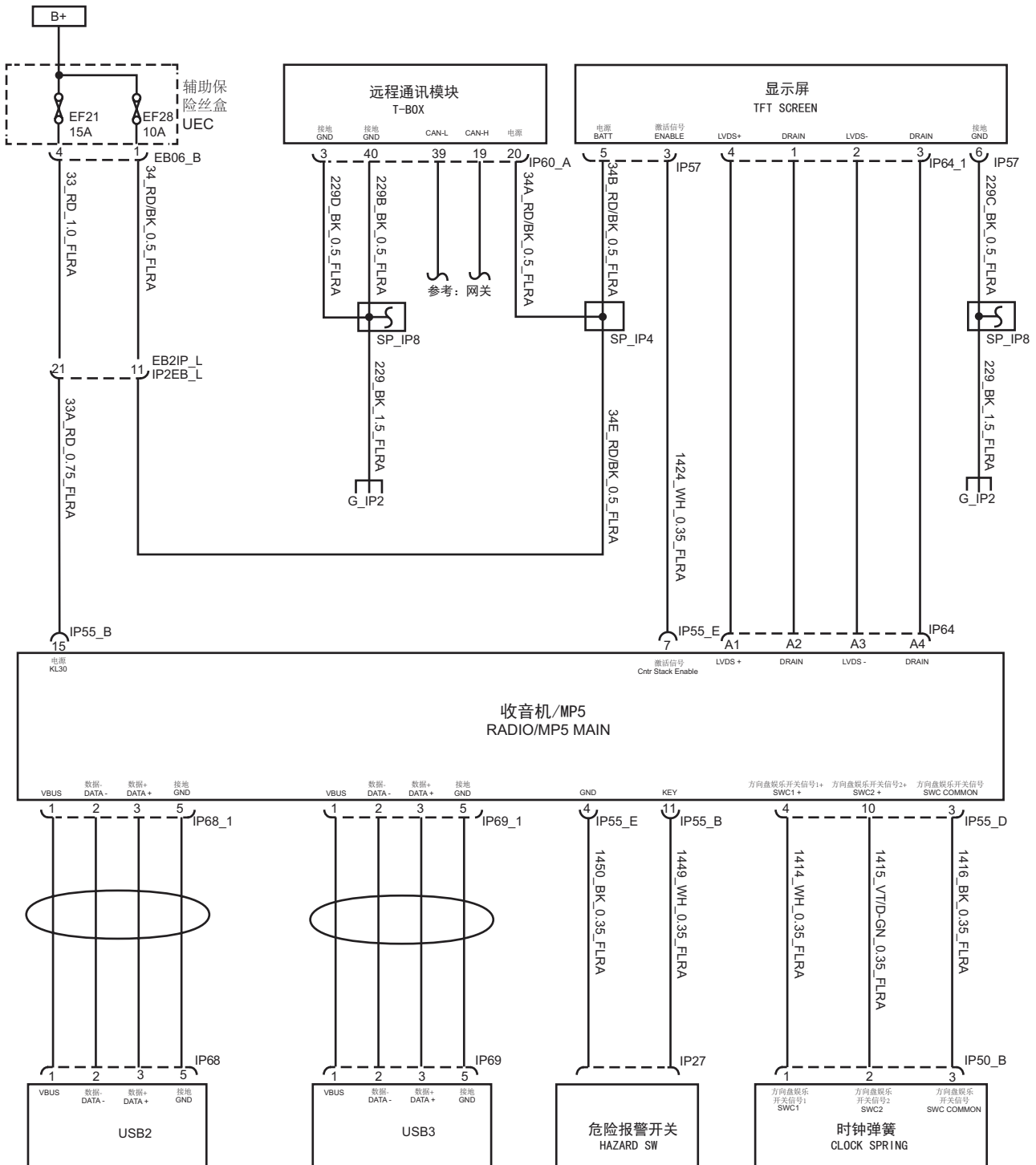

5.8.12 Sound entertainment system (MP5) 2-right rudder

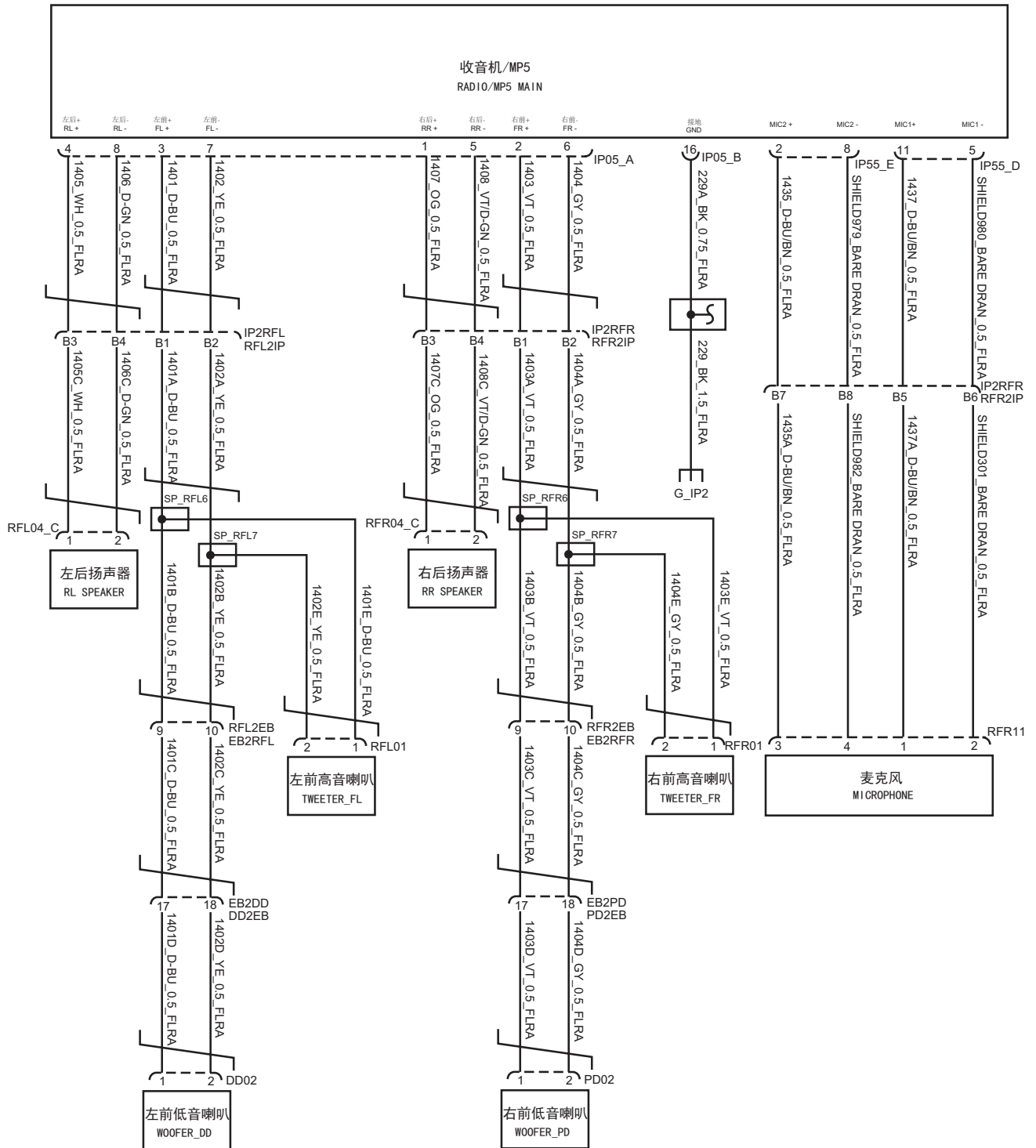

5.8.13 Sound entertainment system (MP5) 3-right rudder

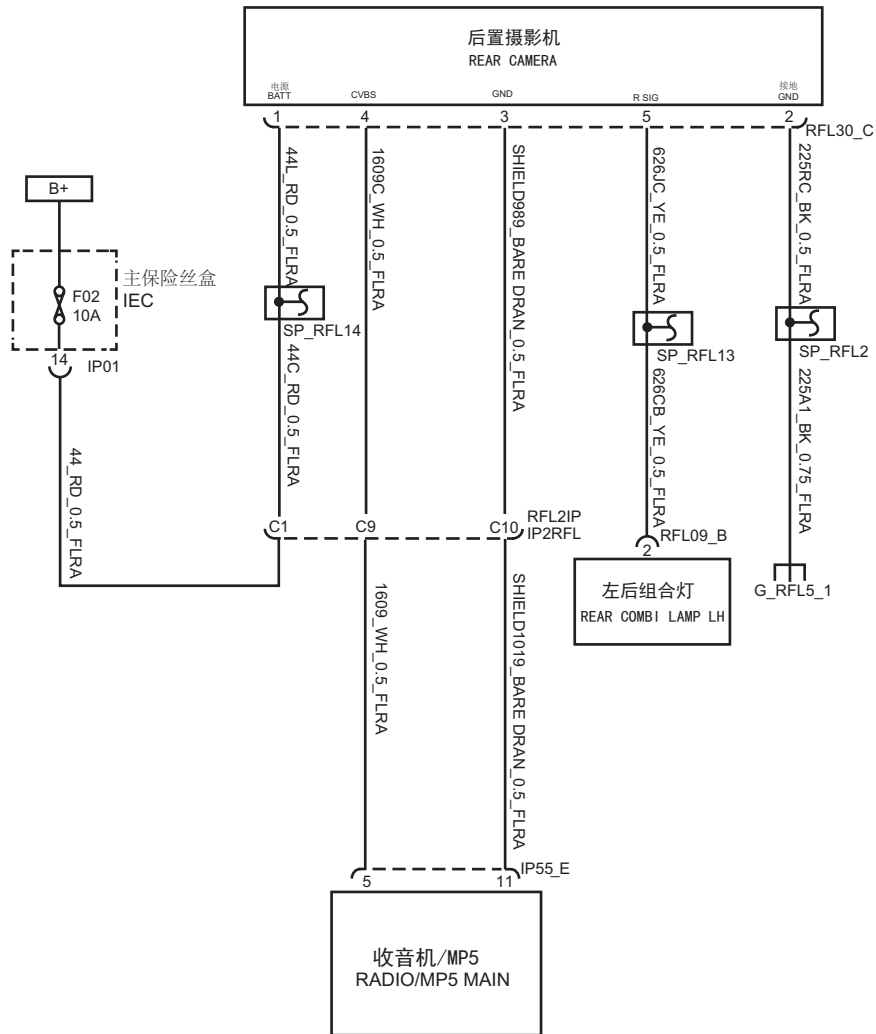

5.8.14 Sound entertainment system (MP5 DR) 1-right rudder

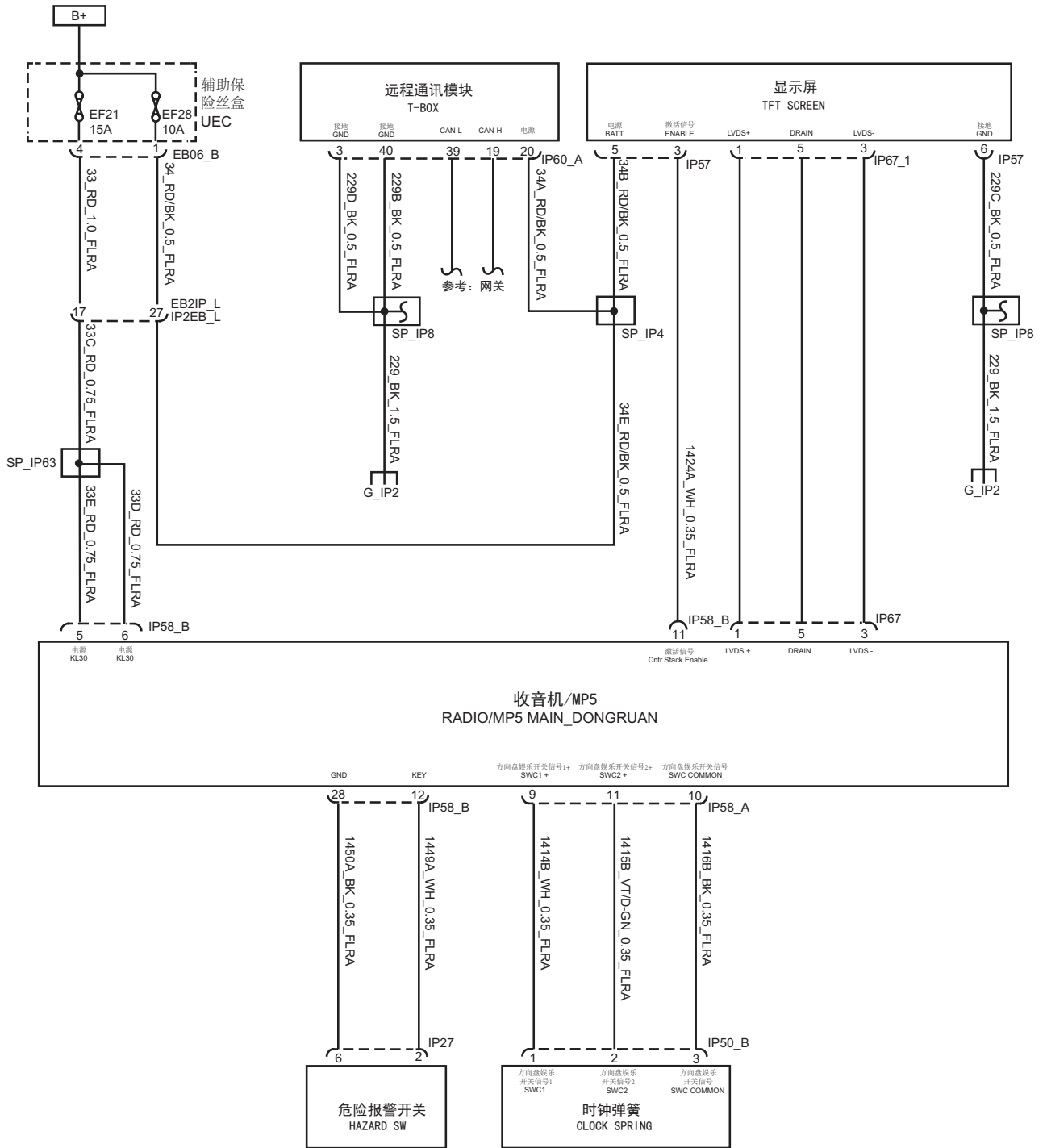

5.8.15 Sound entertainment system (MP5 DR)2-right rudder

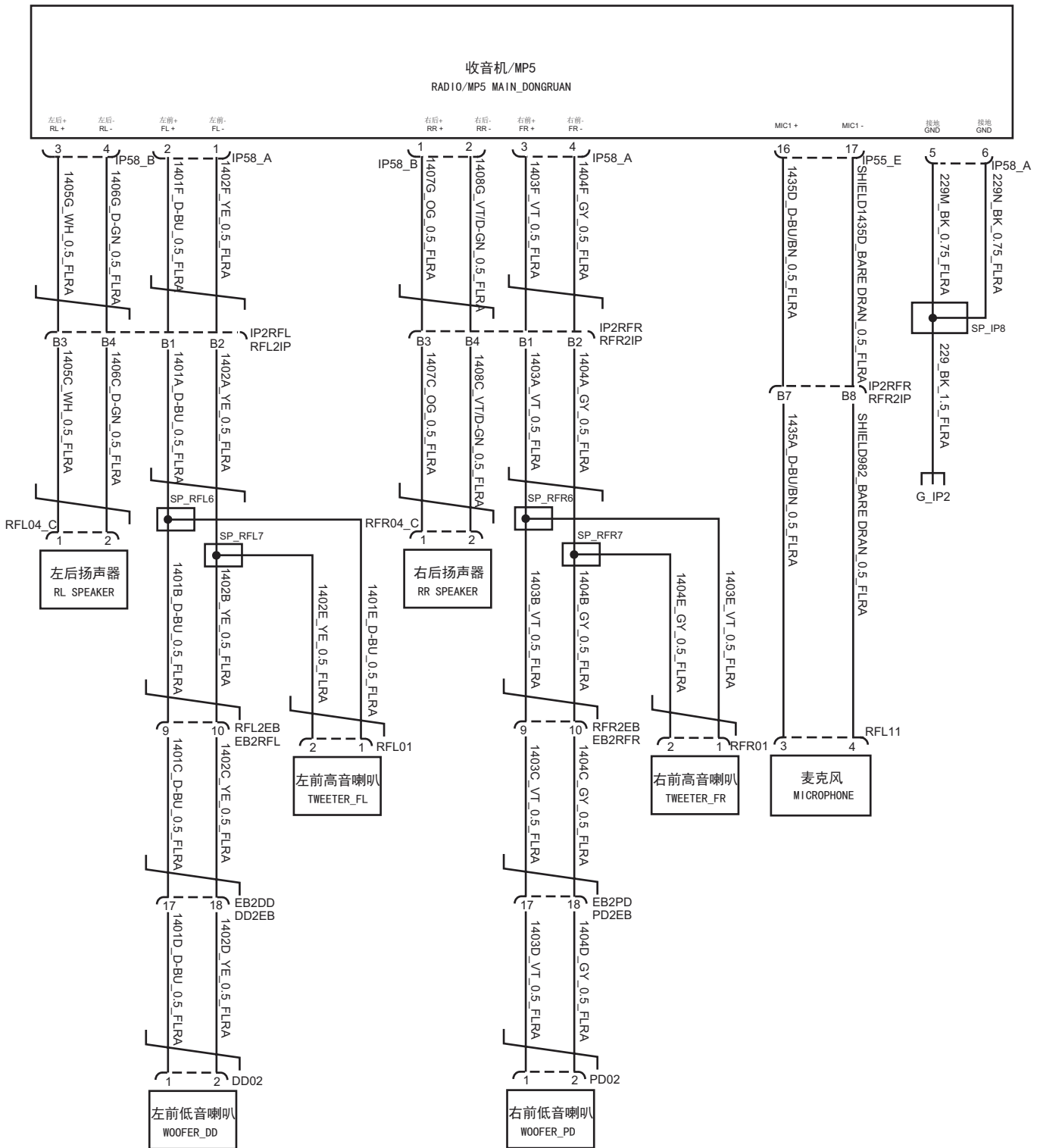

5.8.16 Sound entertainment system (MP5 DR)3-right rudder

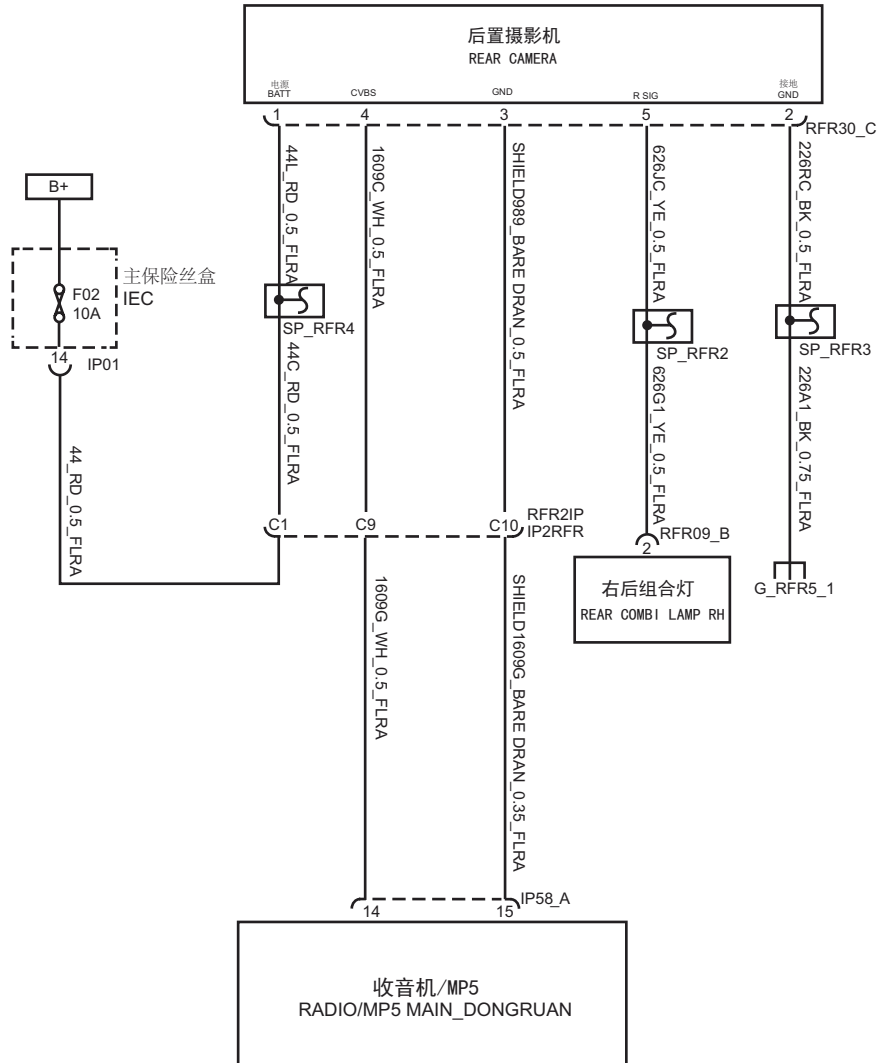

5.9 Body control system

5.9.1 Body control system 1-Left Rudder

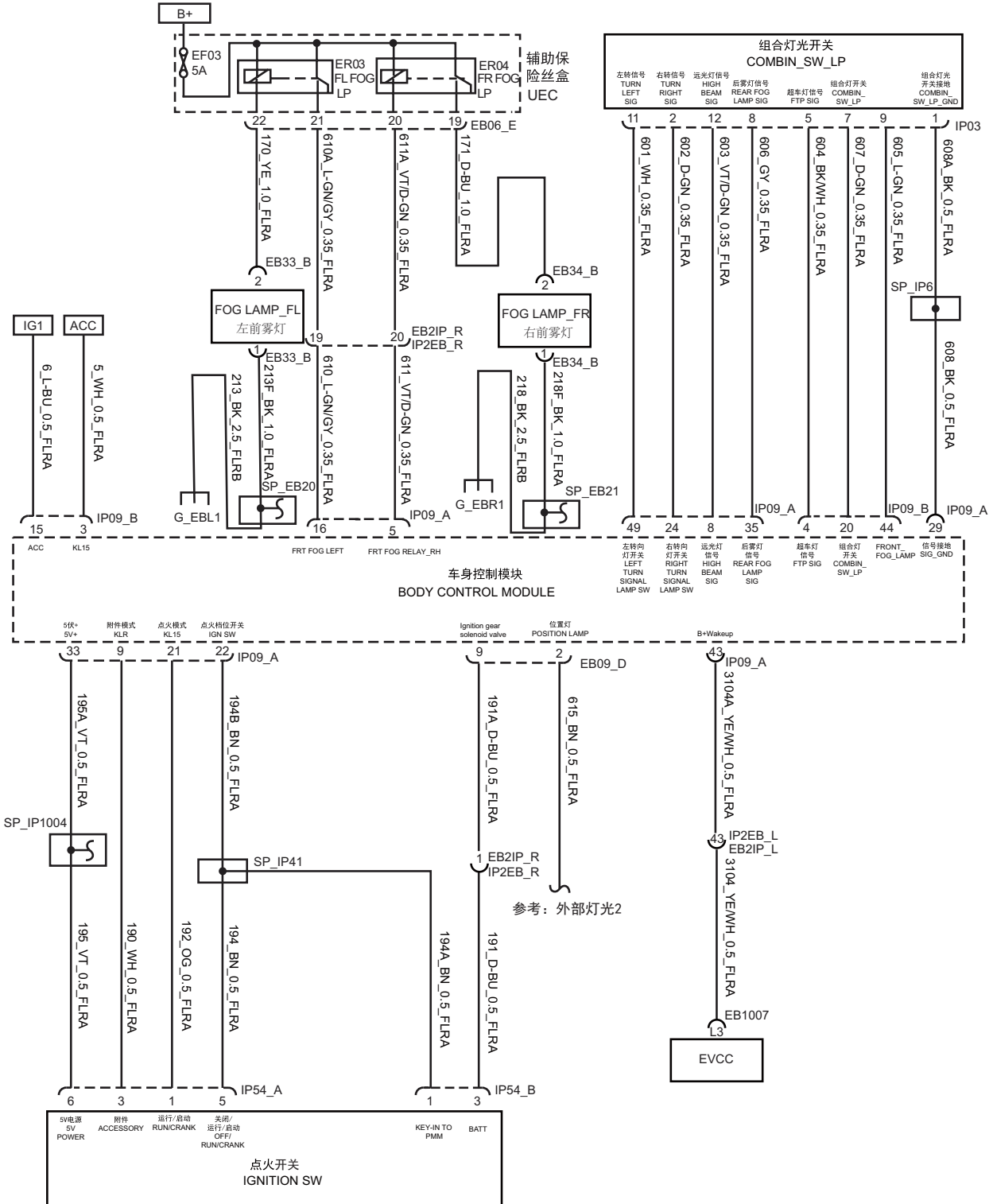

5.9.3 Body control system 3-Left Rudder

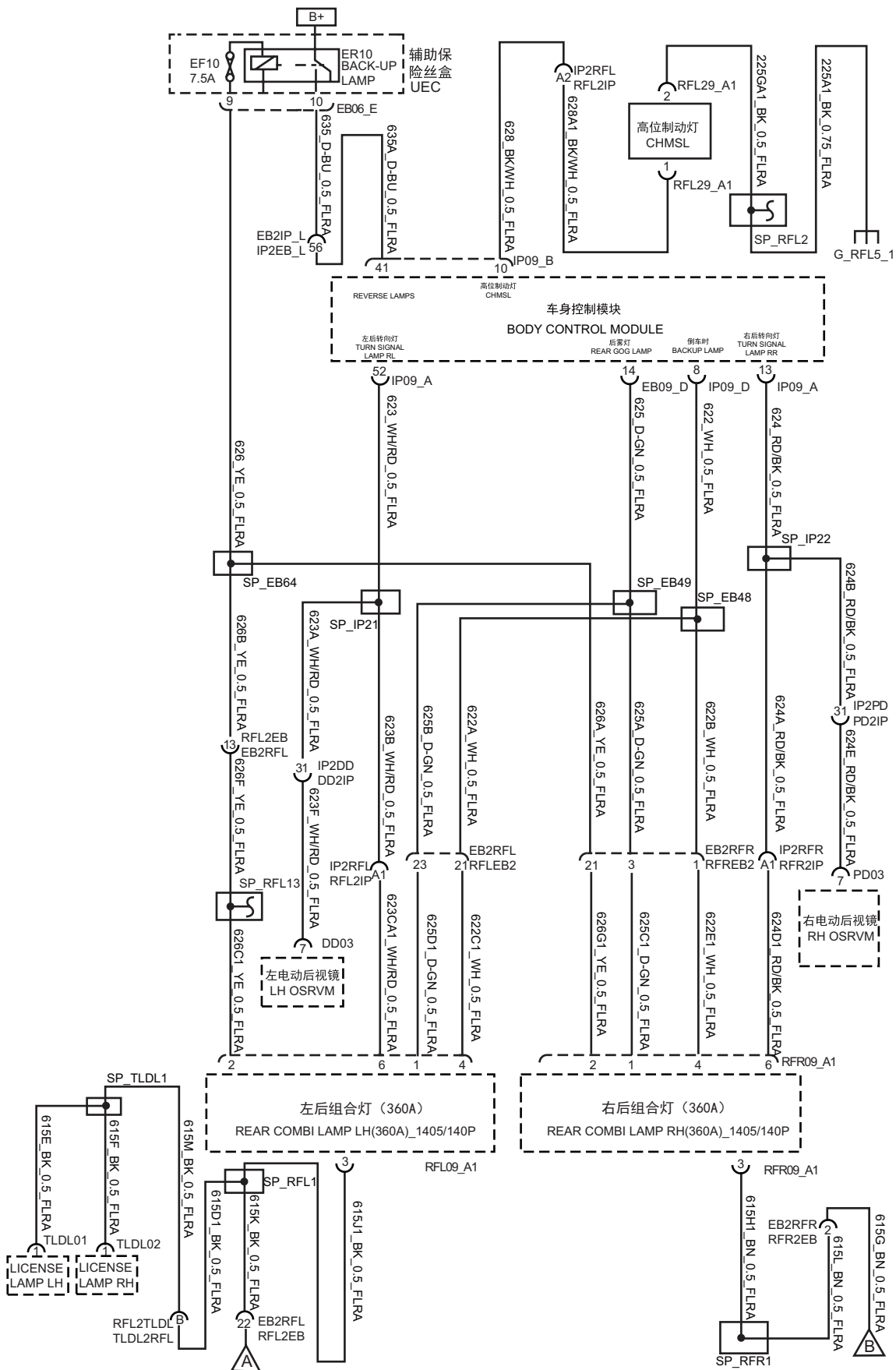

5.9.4 Body control system 4-Left Rudder

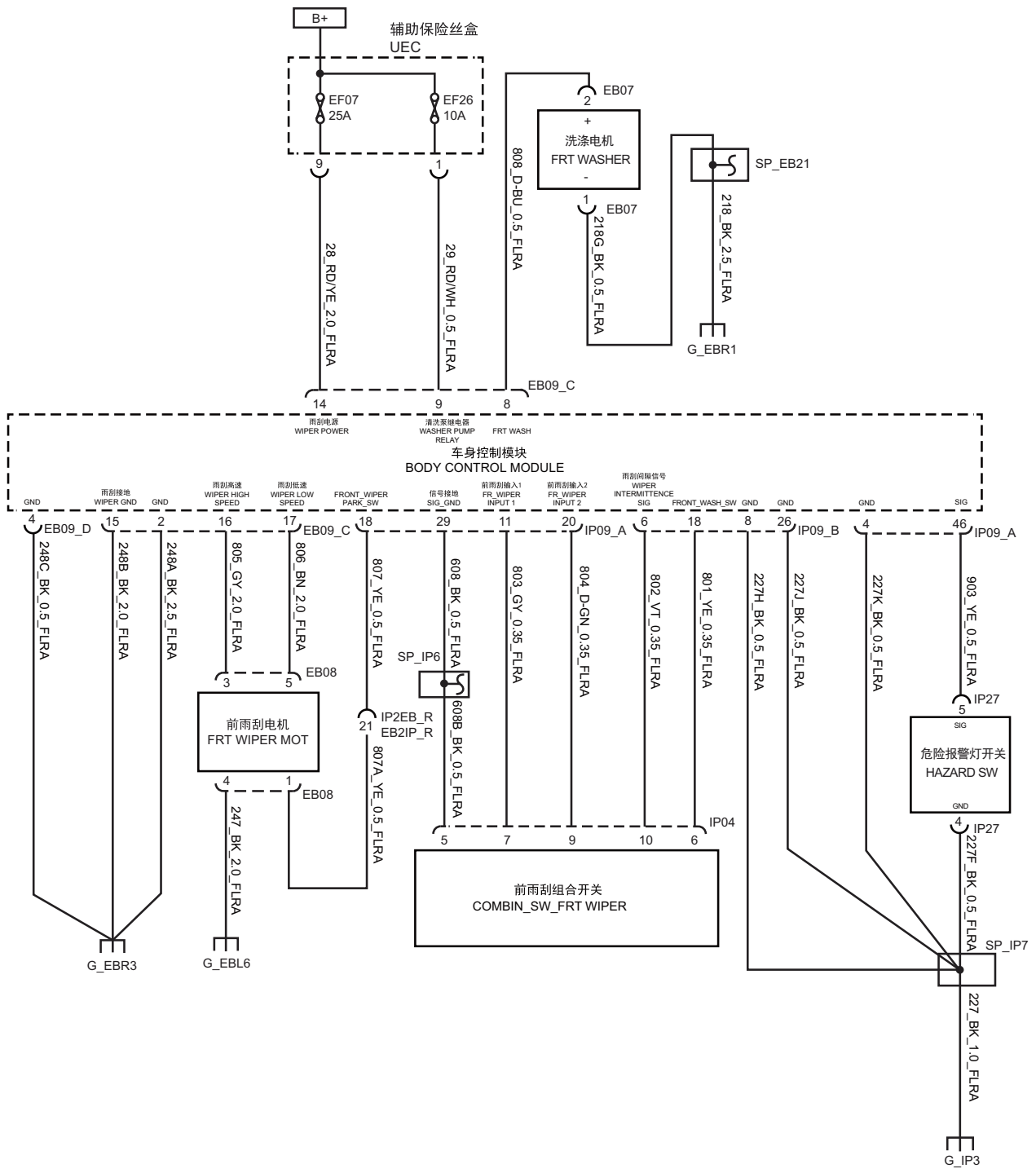

5.9.5 Body control system 5-Left Rudder

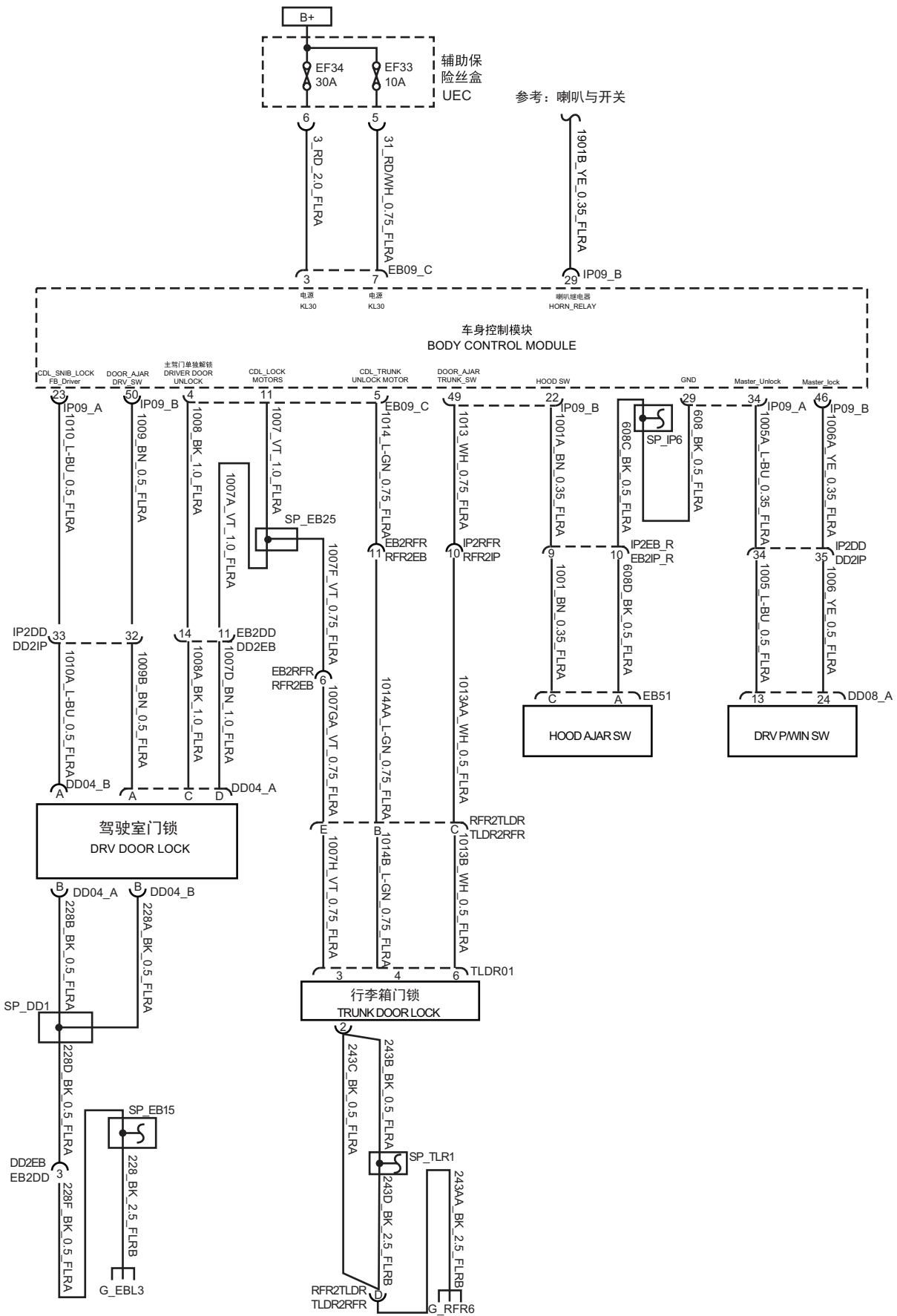

5.9.7 Body control system 7-Left Rudder

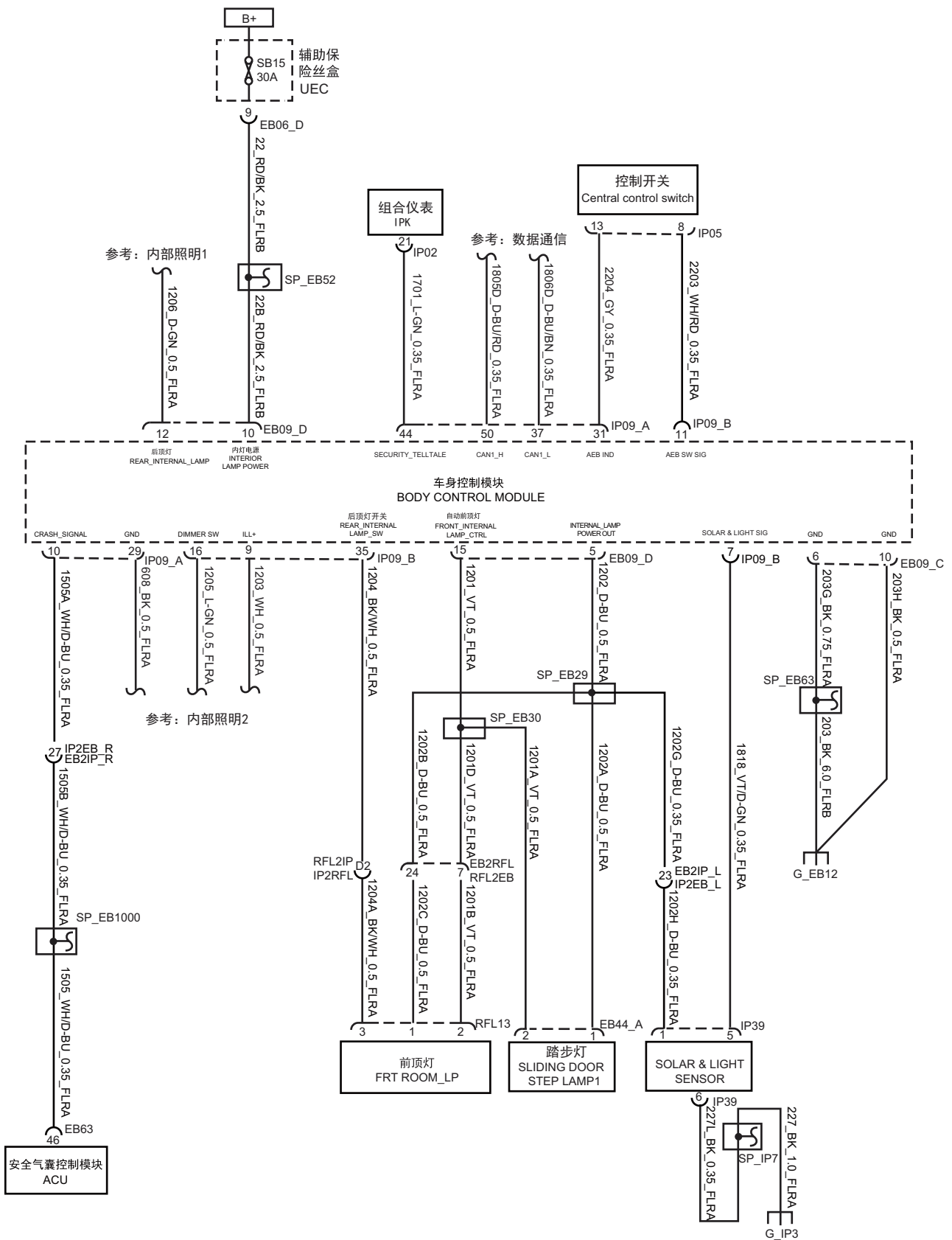

5.9.8 Body control system 8-Left Rudder

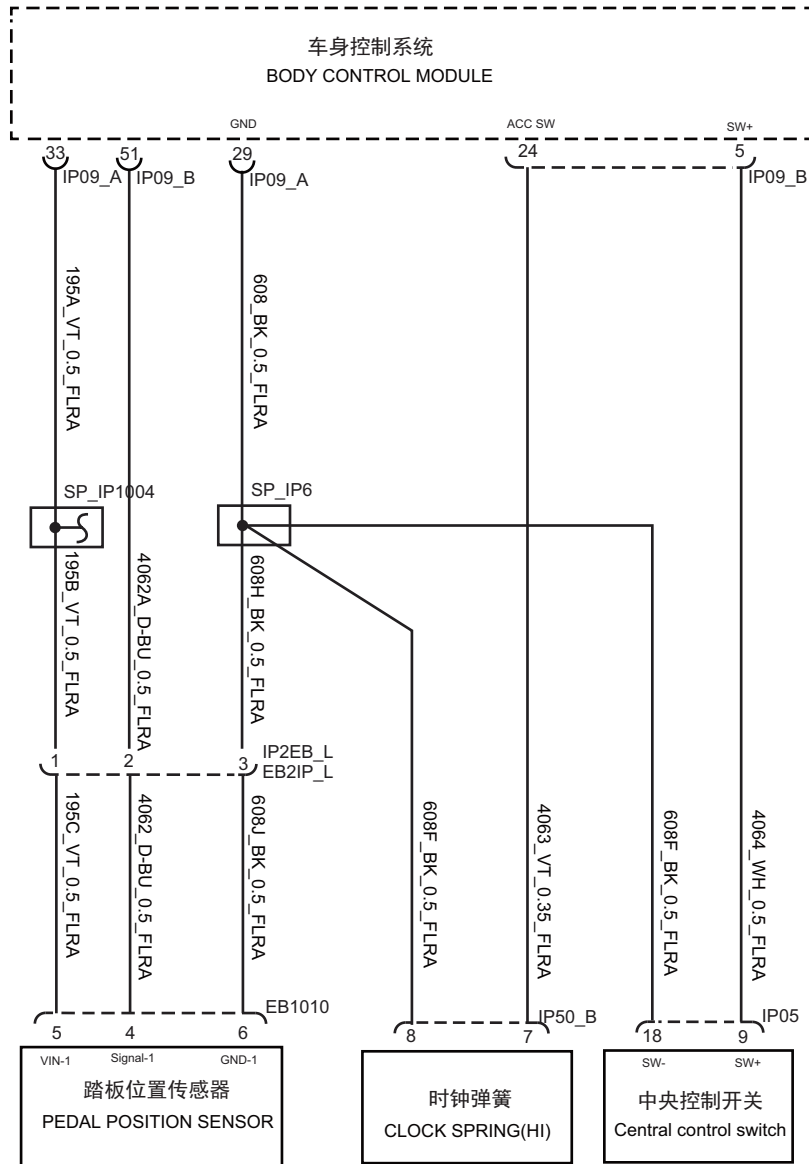

5.9.9 Body control system 1-Right Rudder

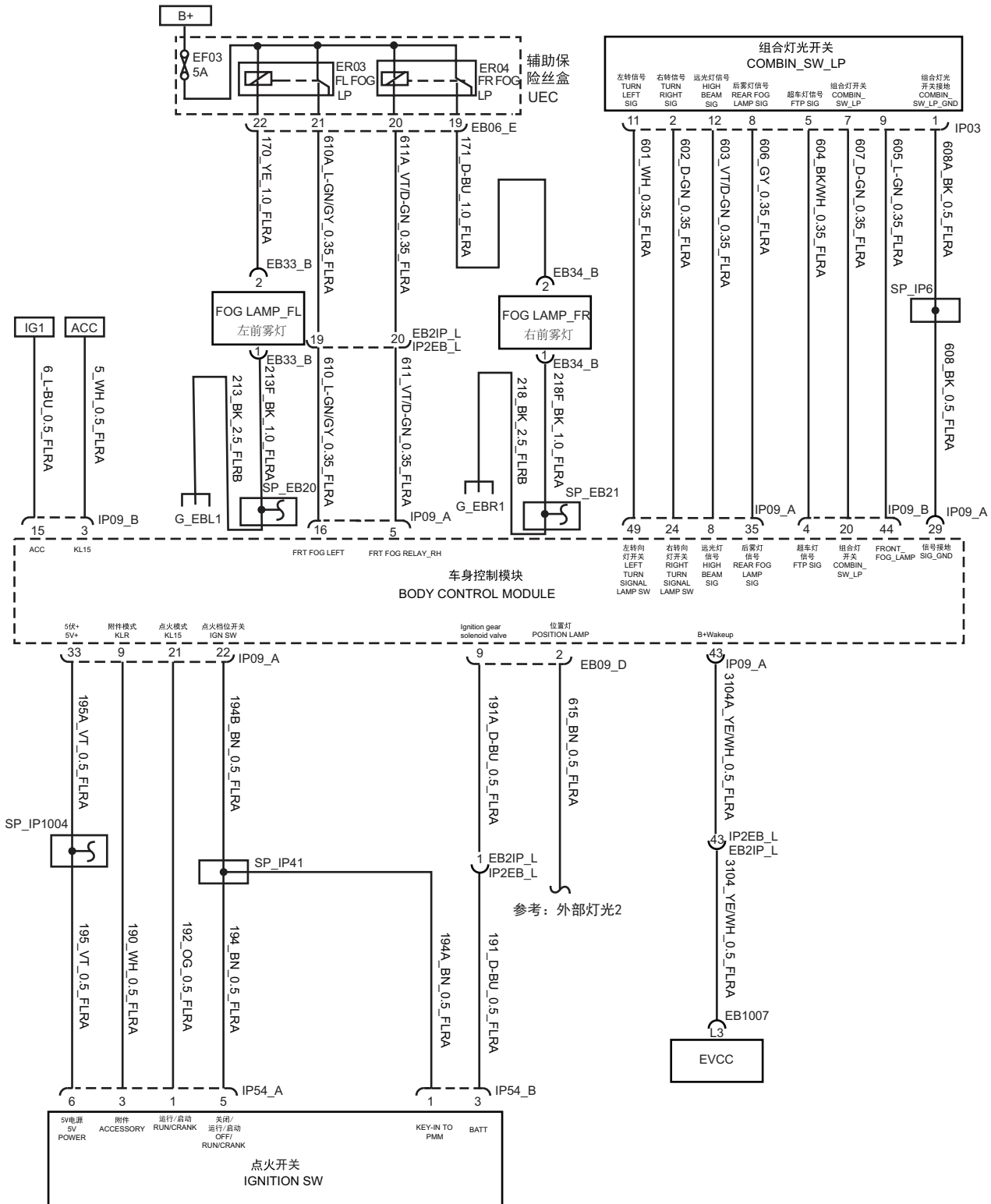

5.9.10 Body control system 2-Right Rudder

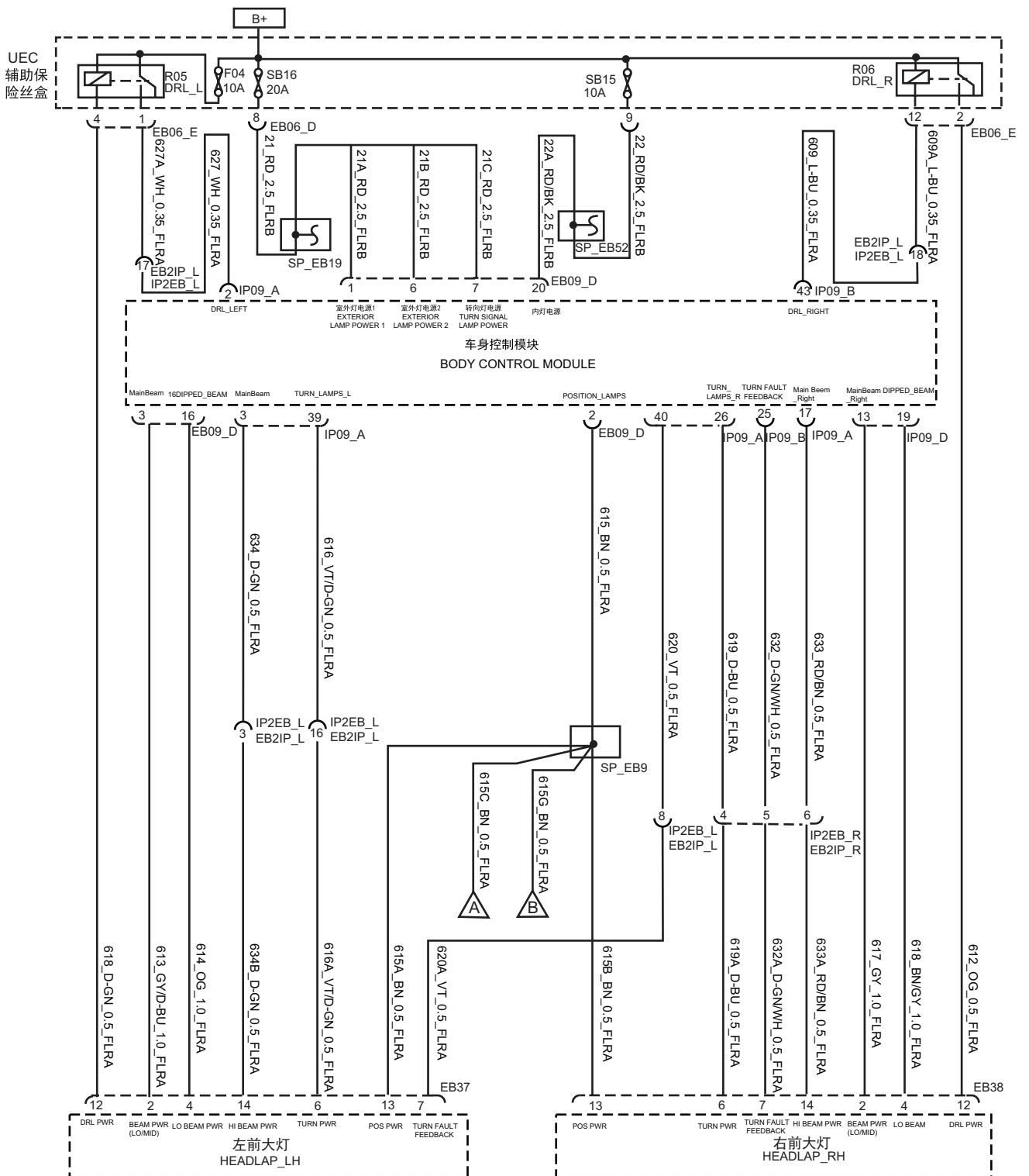

5.9.11 Body control system 3-Right Rudder

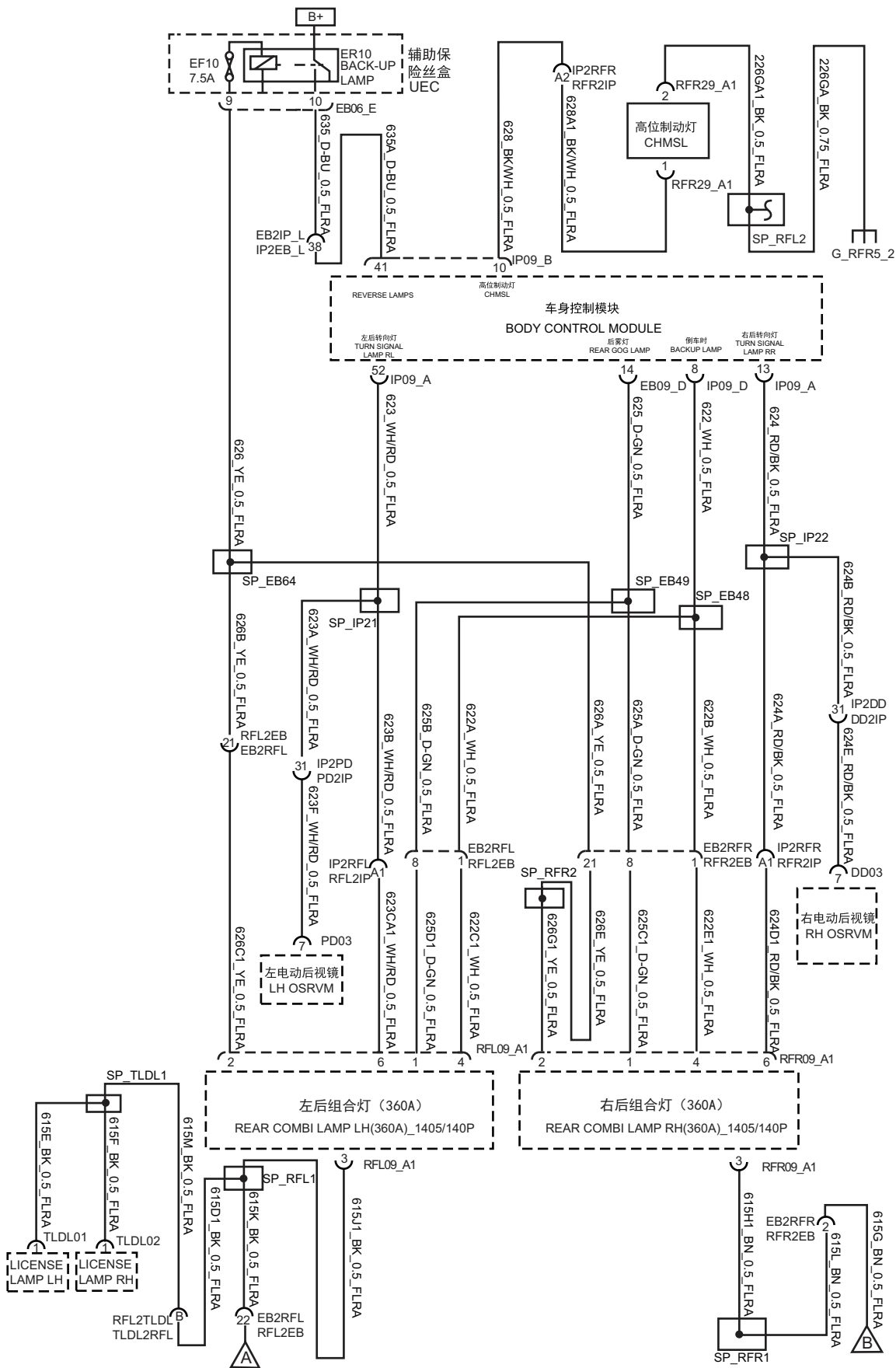

5.9.12 Body control system 4-Right Rudder

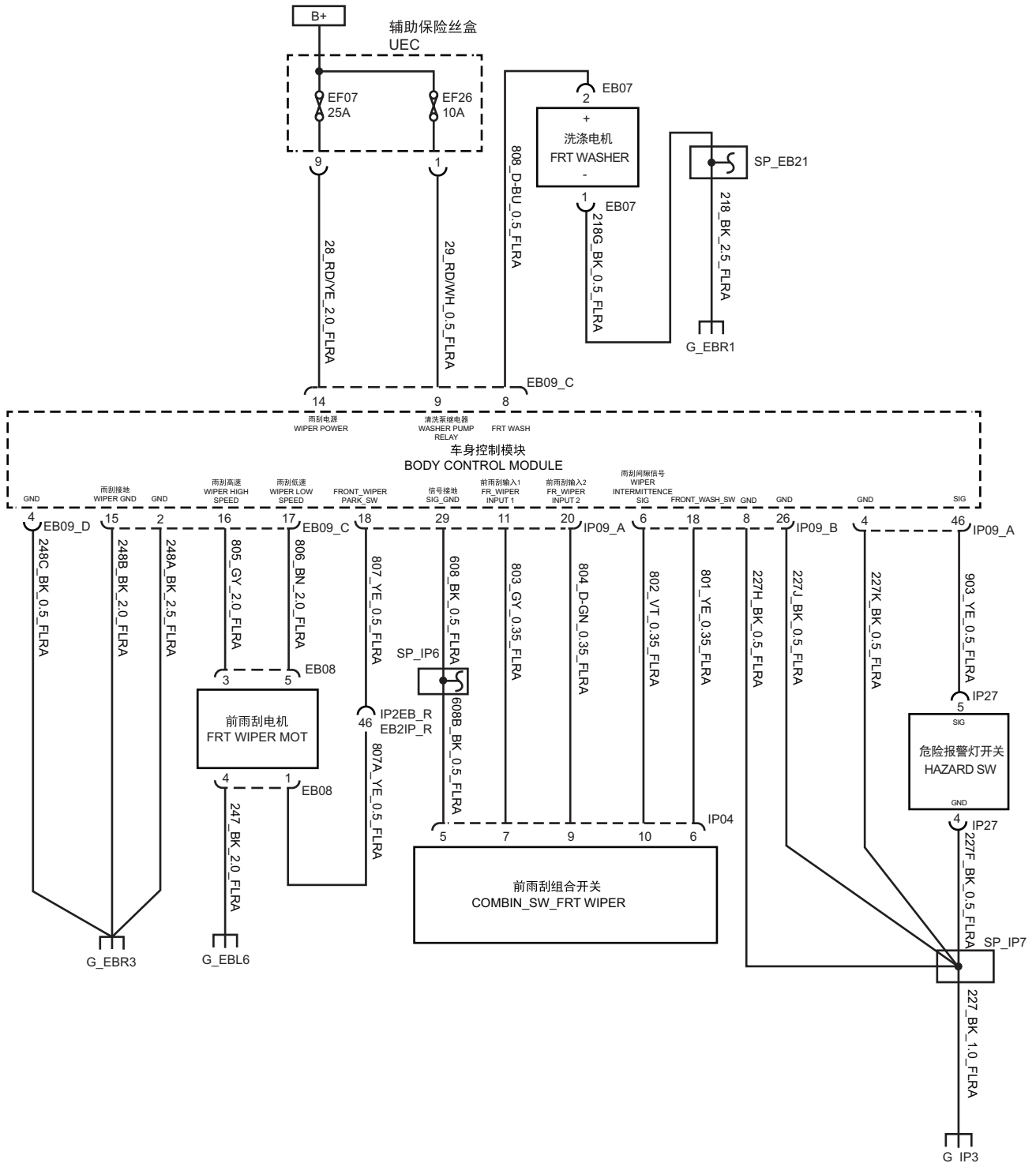

5.9.13 Body control system 5-Right Rudder

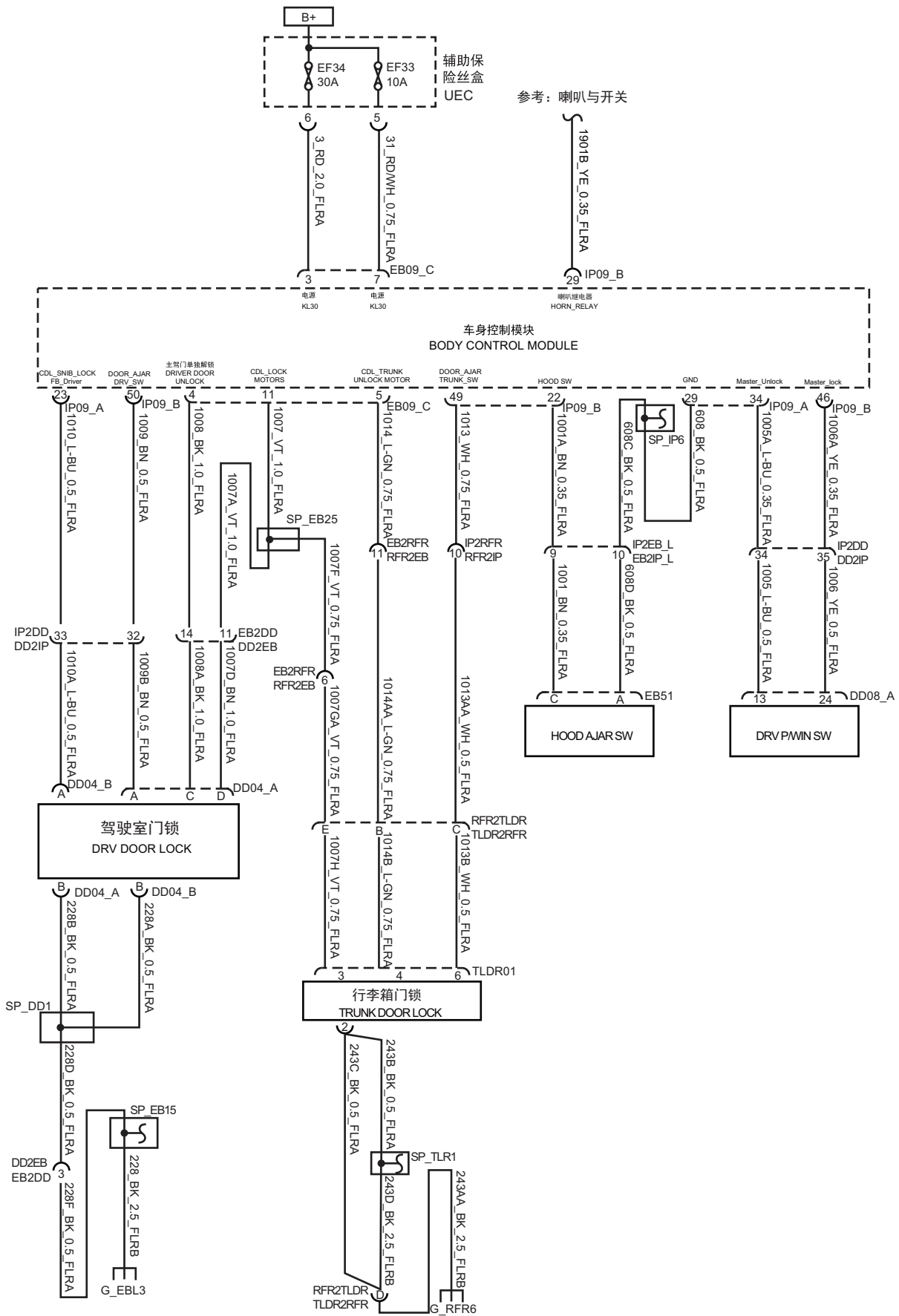

5.9.15 Body control system 7-Right Rudder

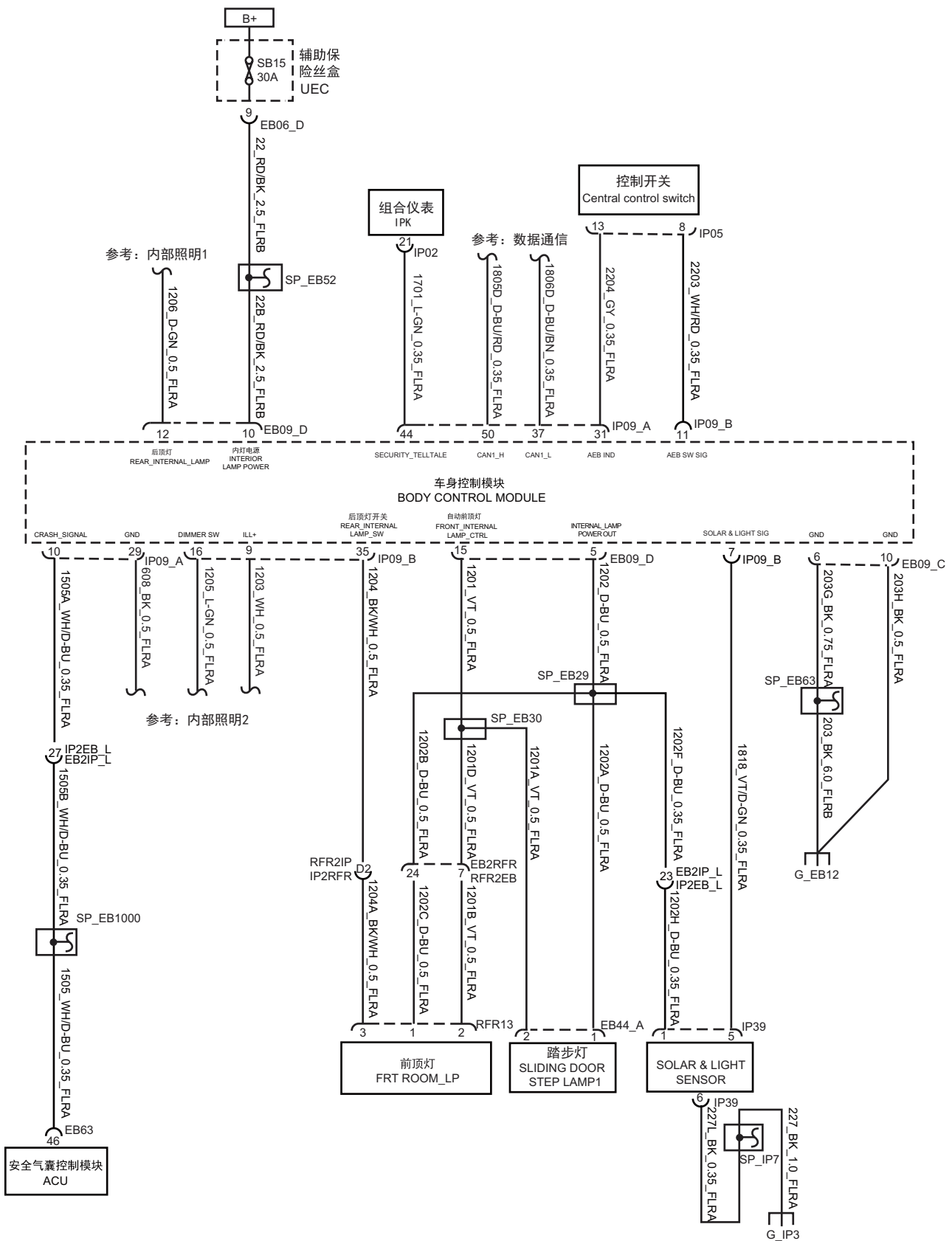

5.9.16 Body control system 8-Right Rudder

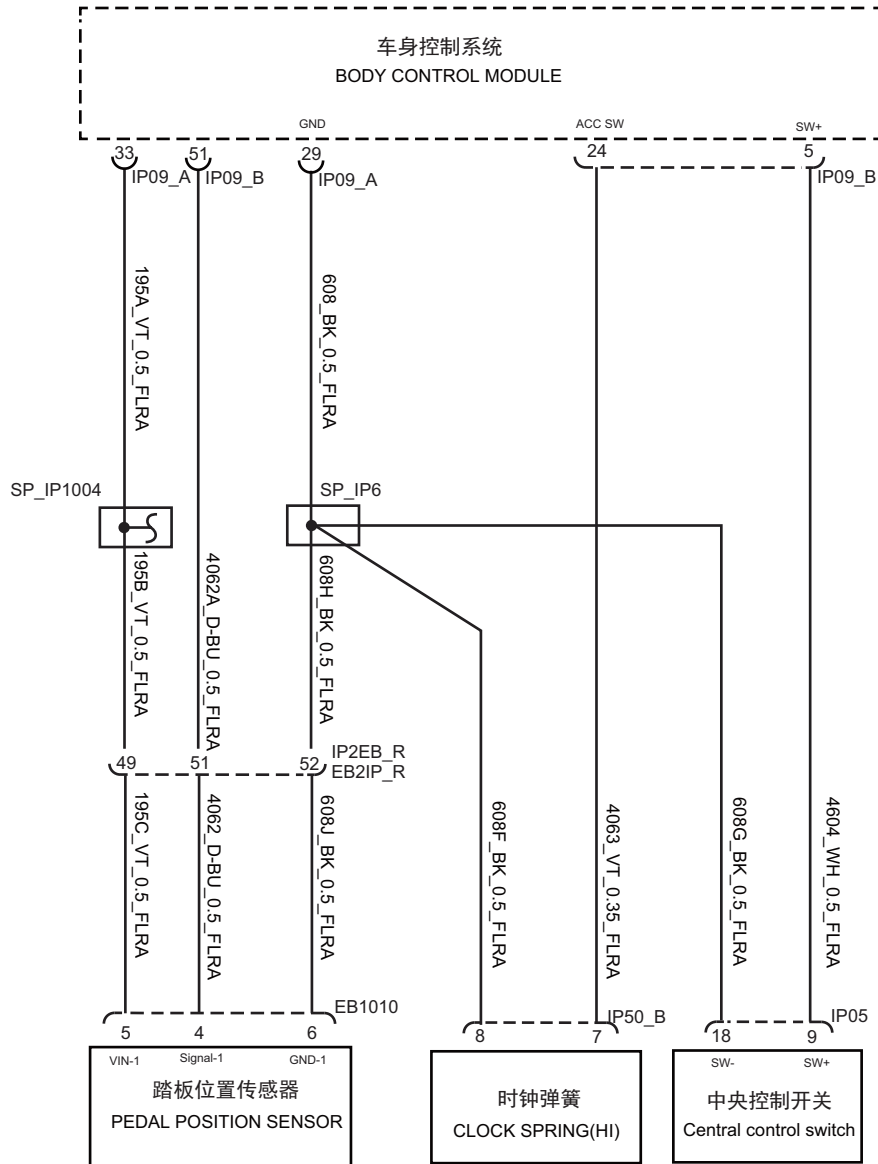

5.10 Outside rearview mirror

5.10.1 Outside rearview mirror 1 -Left Rudder

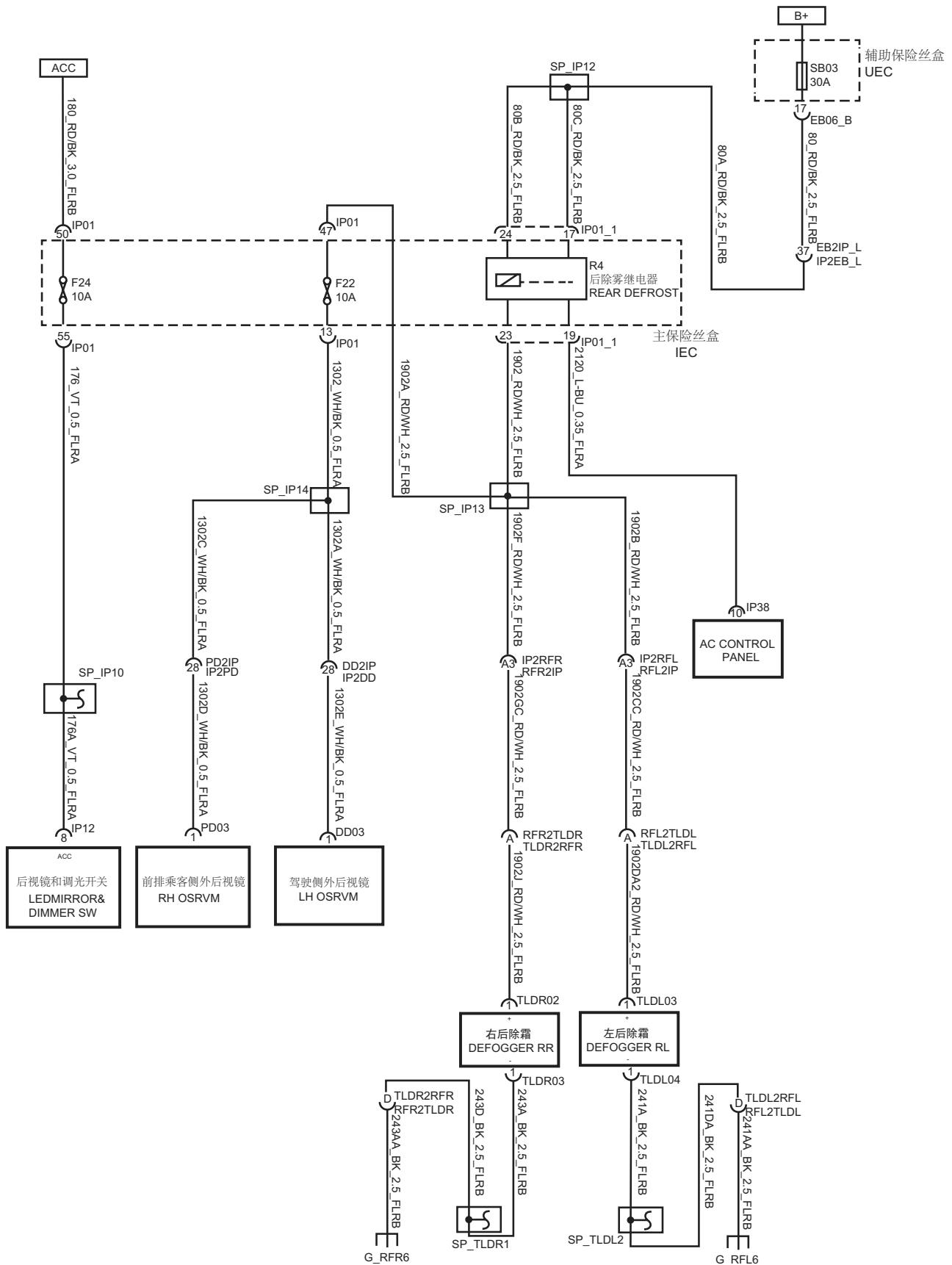

5.10.2 Outside rearview mirror 2 -Left Rudder

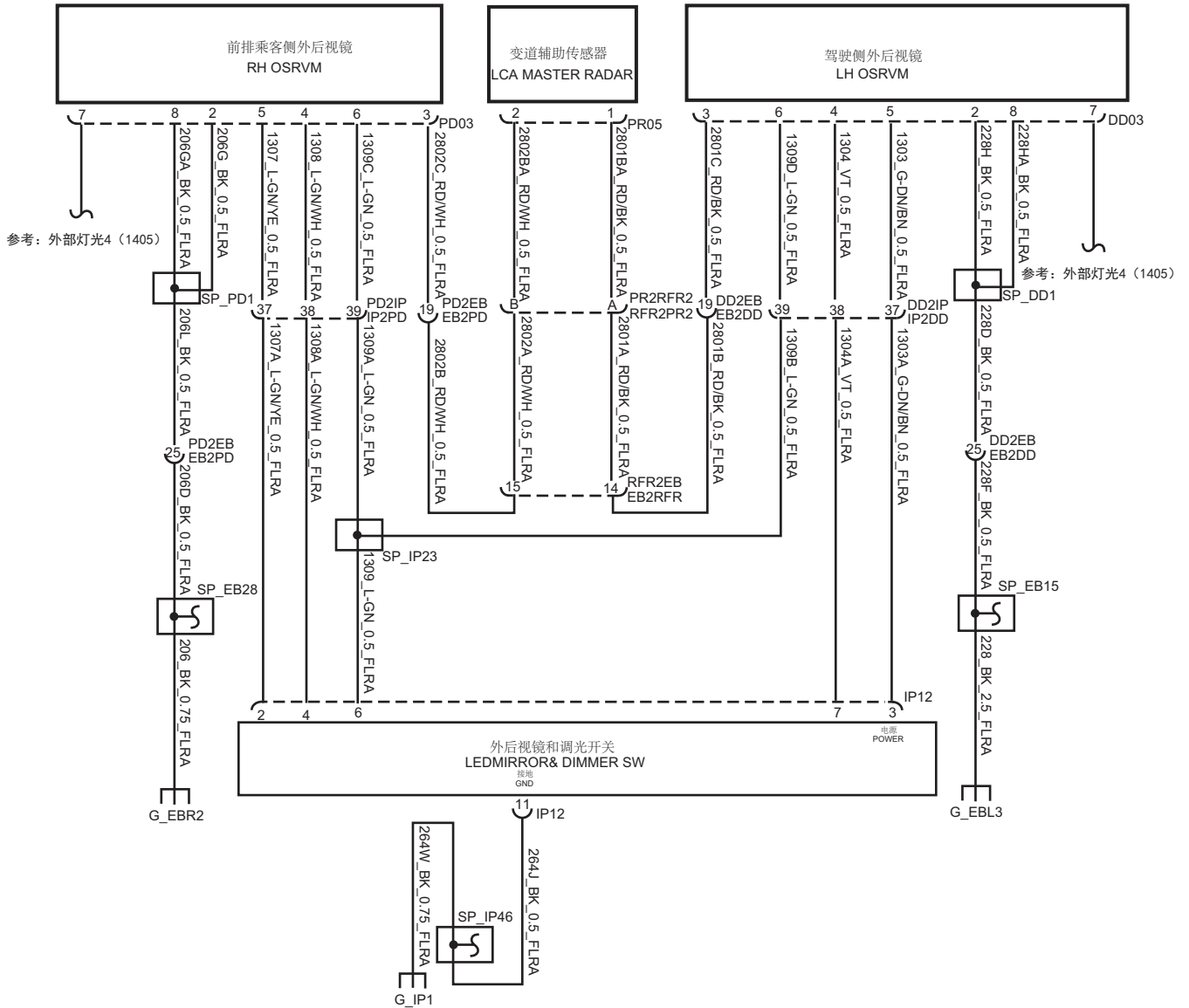

5.10.3 Outside rearview mirror 1 - Right Rudder

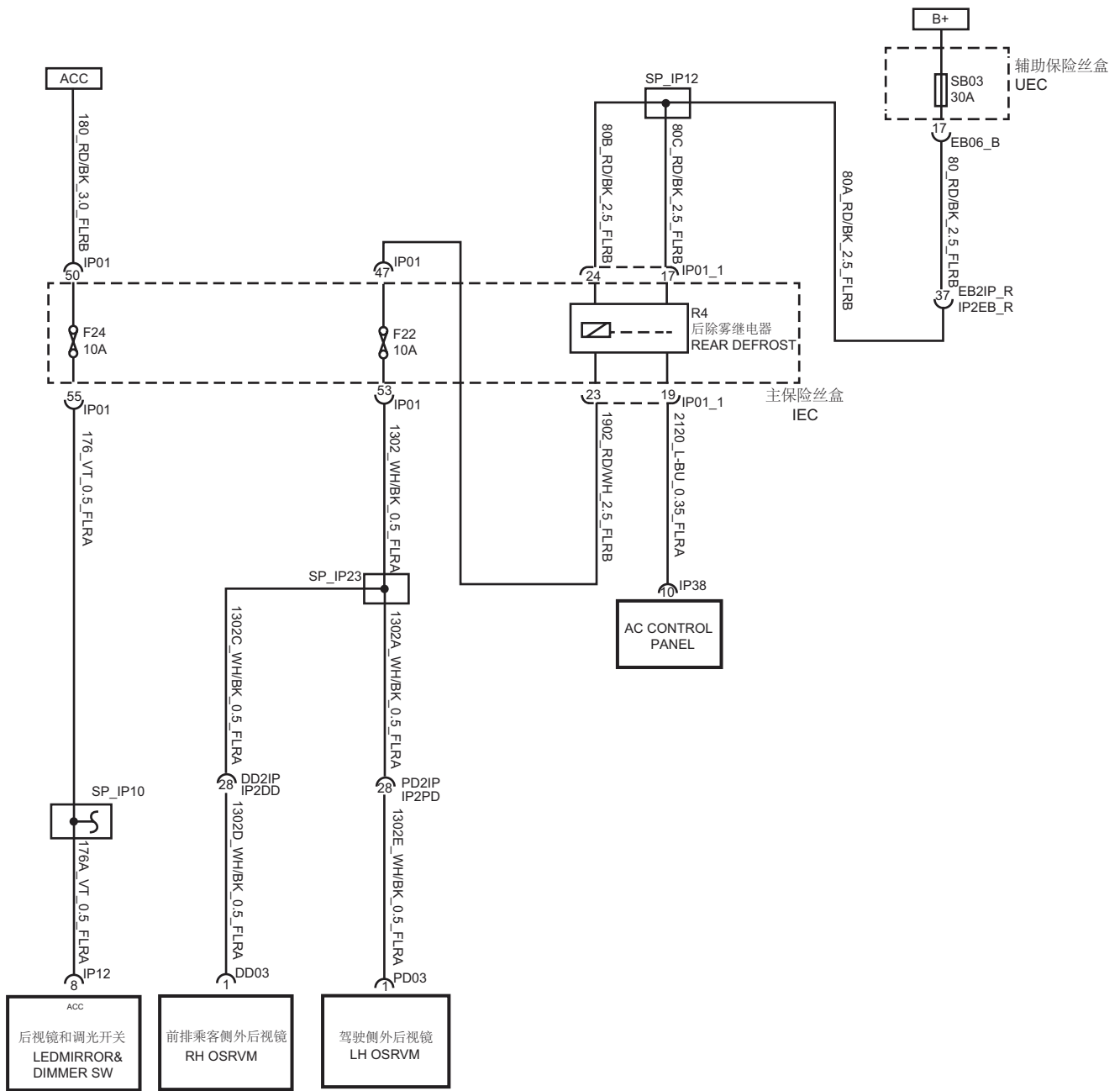

5.10.4 Outside rearview mirror 2 - Right Rudder

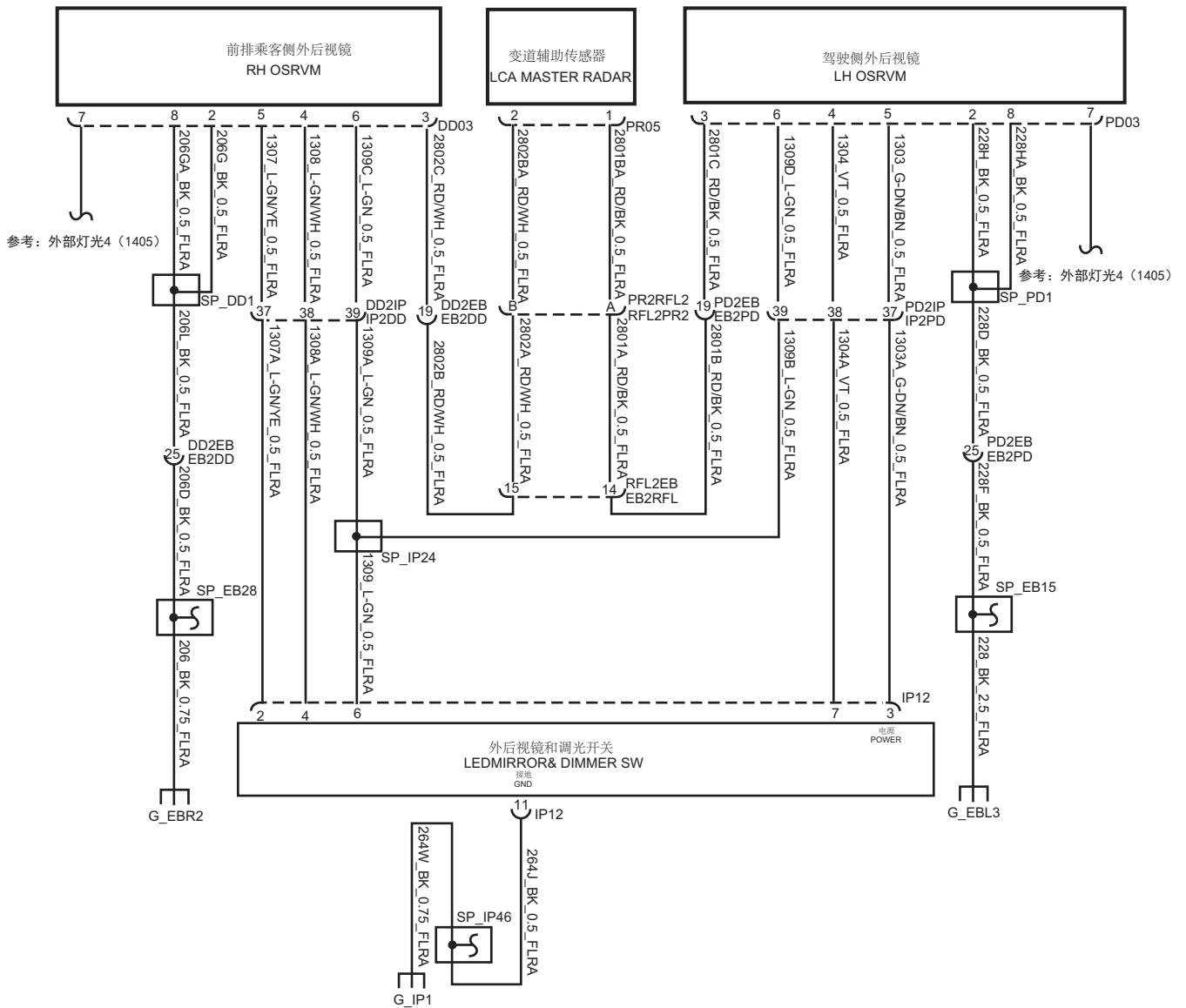

5.11.2 IPK System – Right Rudder

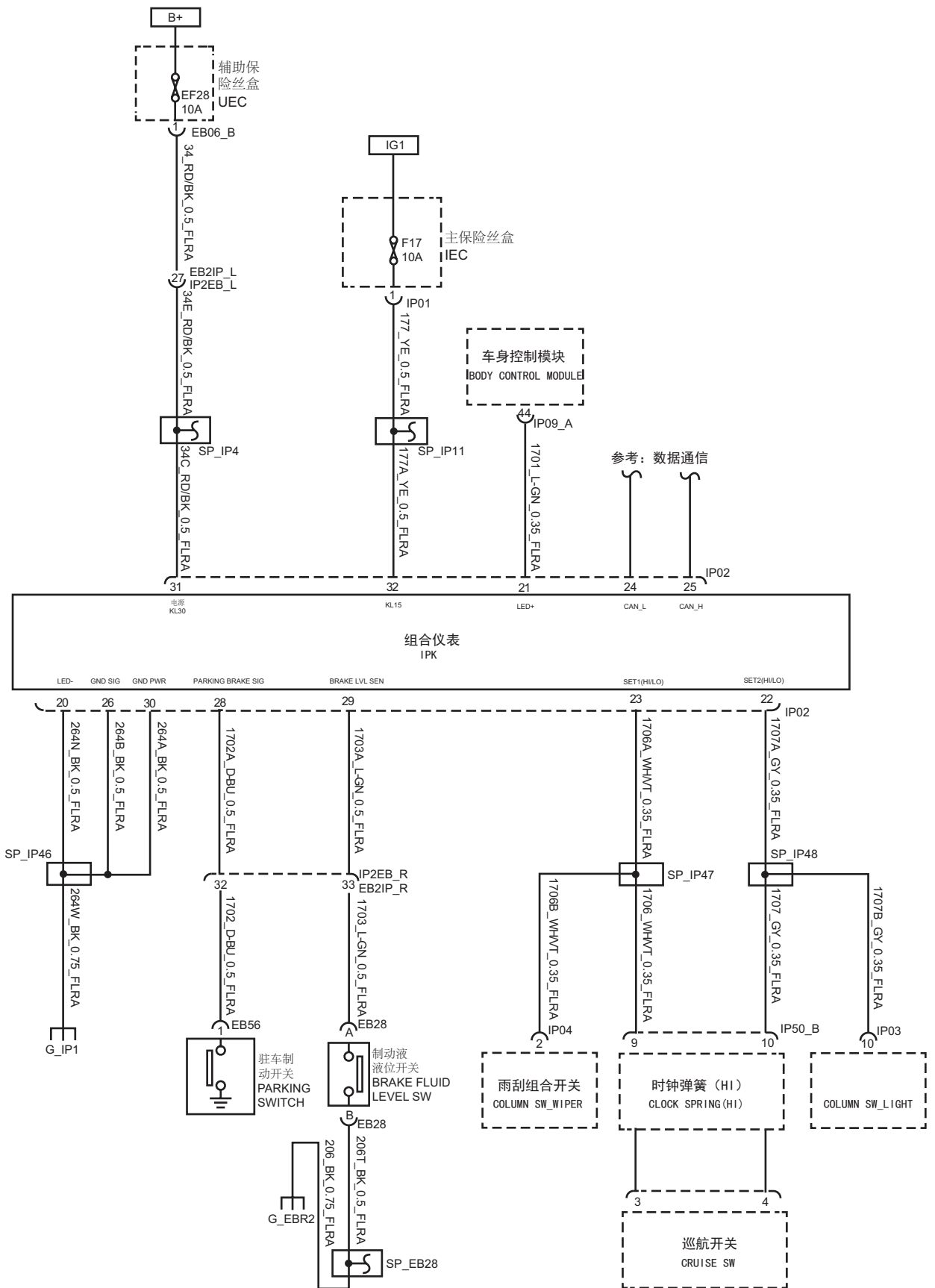

5.12 AVAS System

5.12.1 AVAS System - Left Rudder

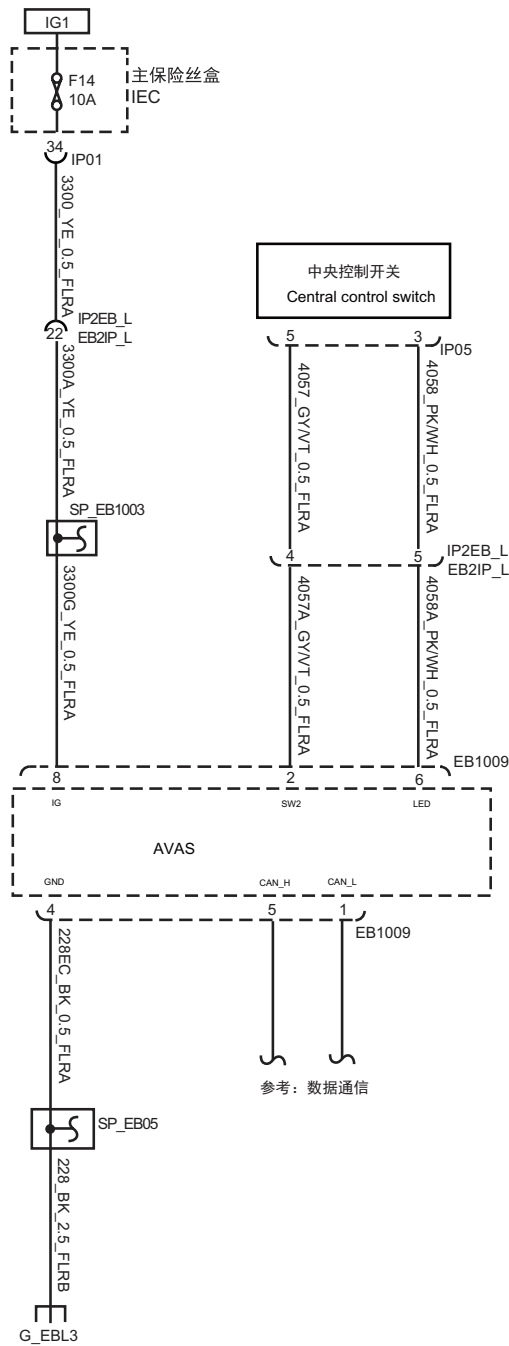

5.12.2 AVAS System – Right Rudder

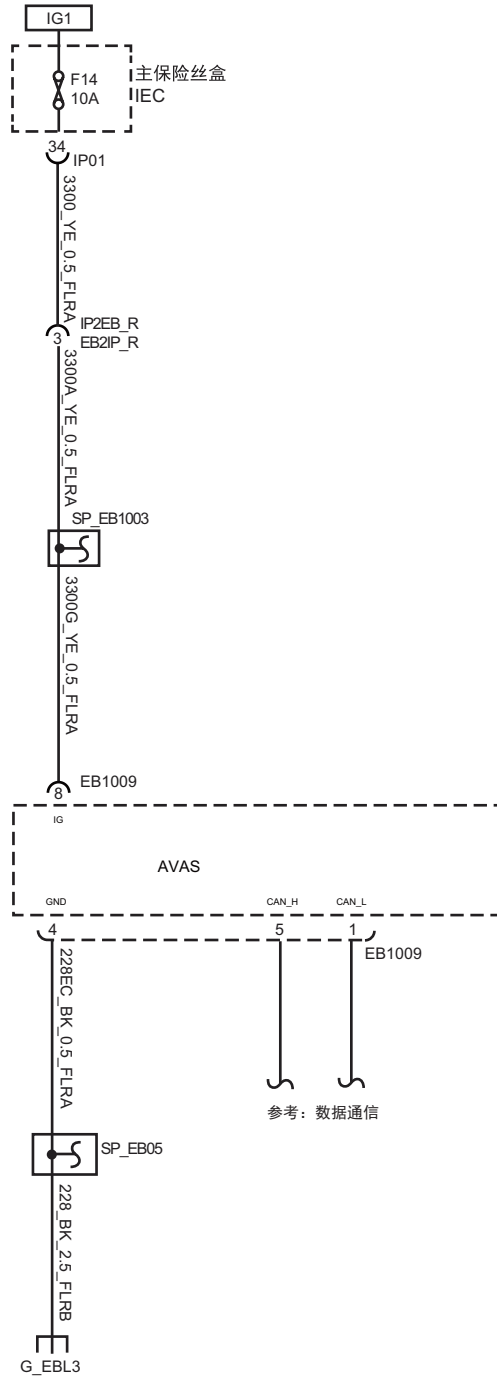

5.13 PEB System

5.13.1 PEB System - Left Rudder

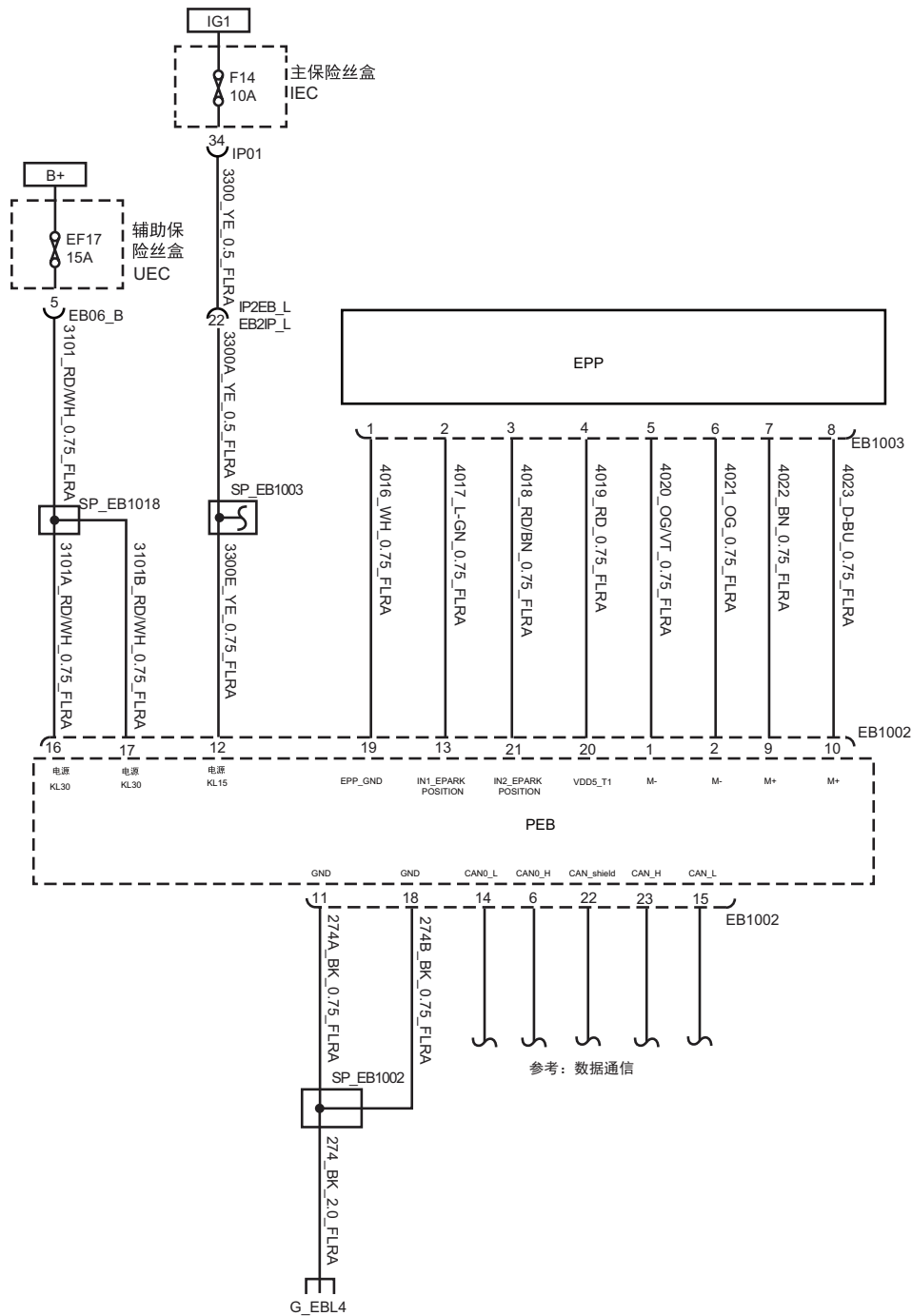

5.13.2 PEB System – Right Rudder

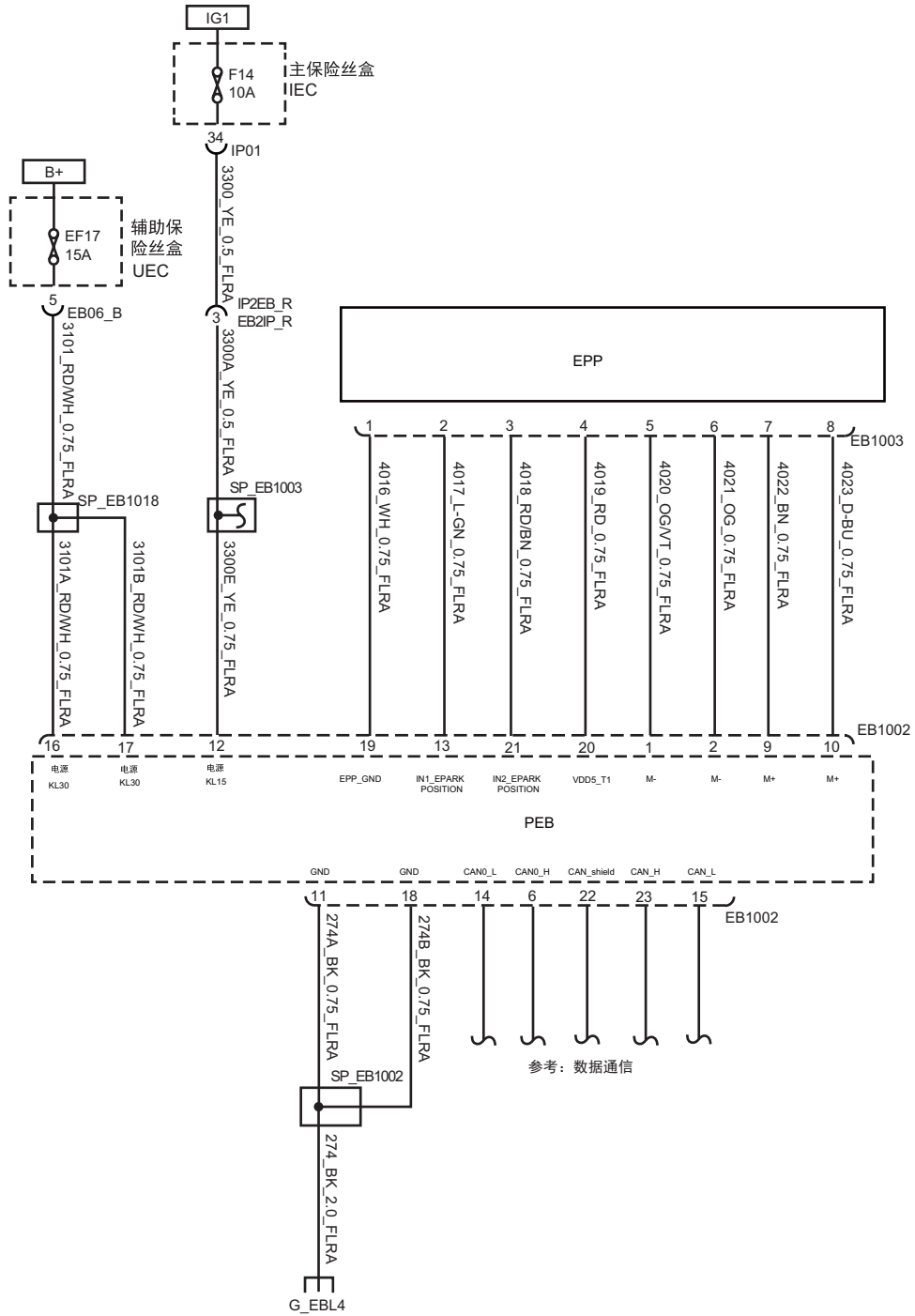

5.14 Cigar Lighter Sytem

5.14.1 Cigar Lighter Sytem - Left Rudder

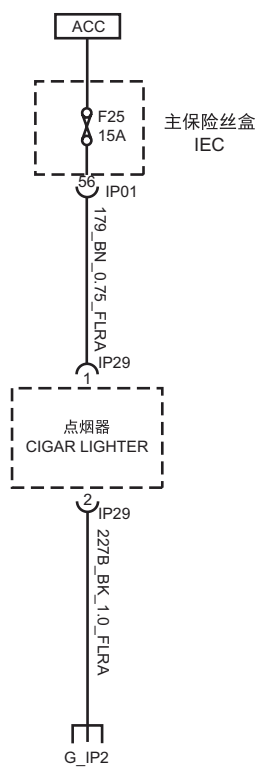

5.14.2 Cigar Lighter System - Right Rudder

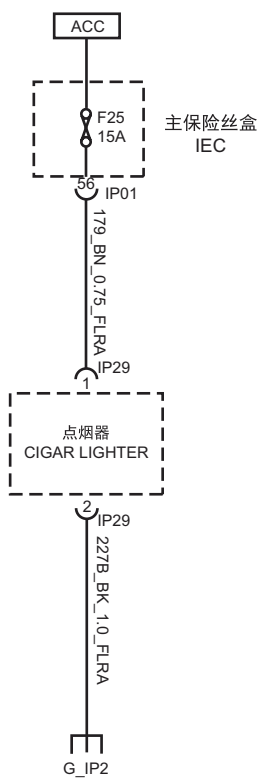

5.15 Lane change assist system

5.15.1 Lane change assist system - Left Rudder

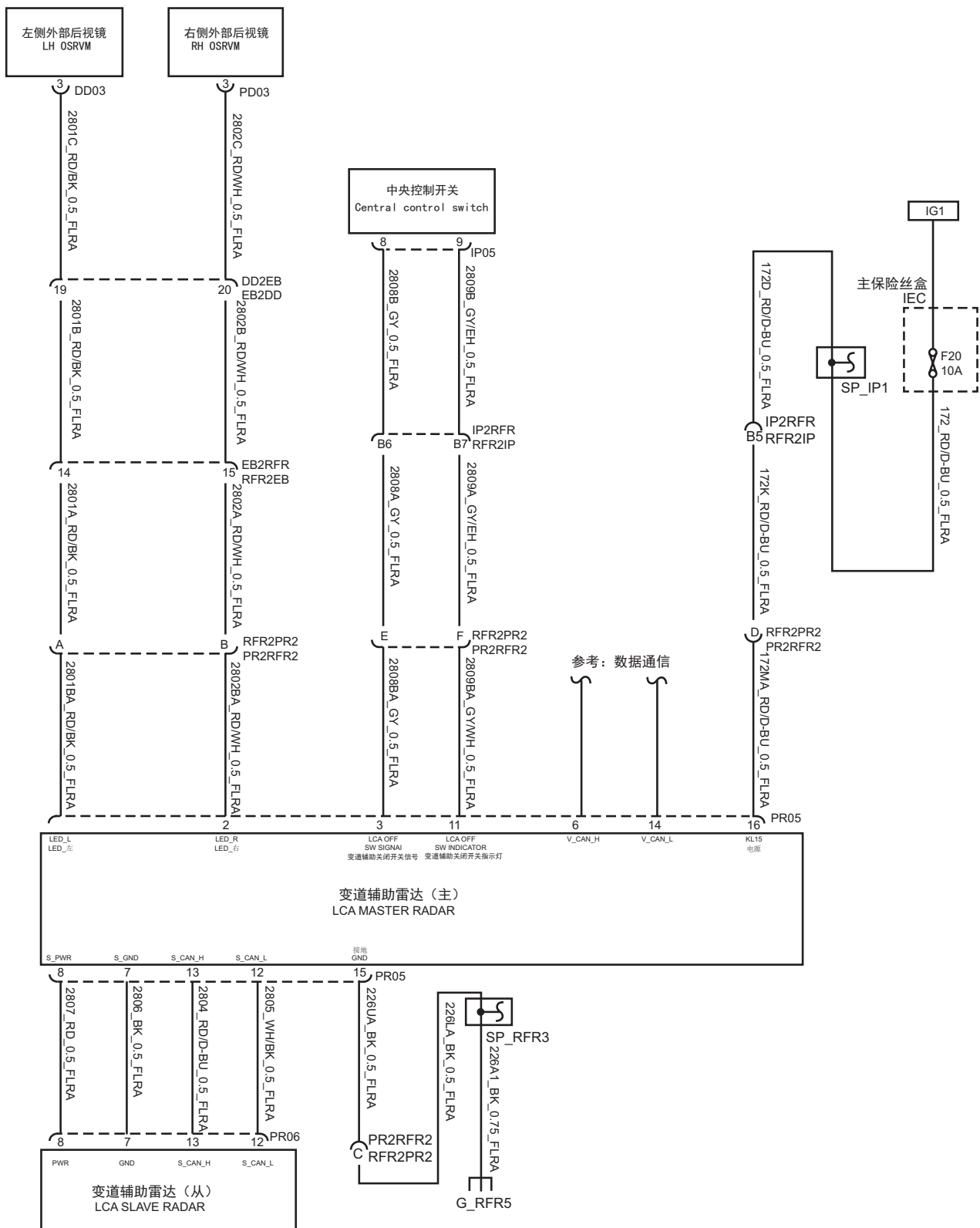

5.15.2 Lane change assist system – Right Rudder

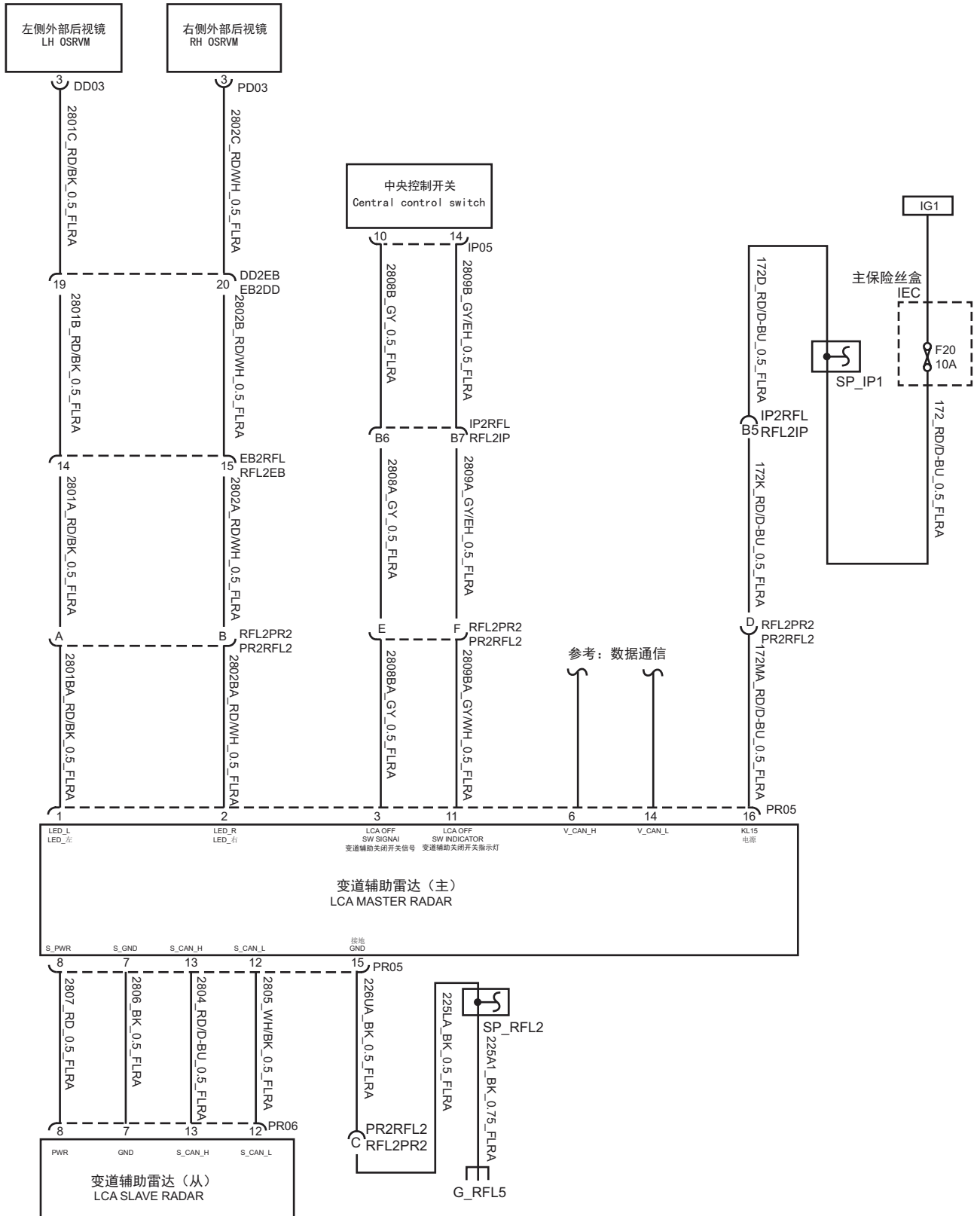

5.16 T-BOX system

5.16.1 T-BOX system - Left Rudder

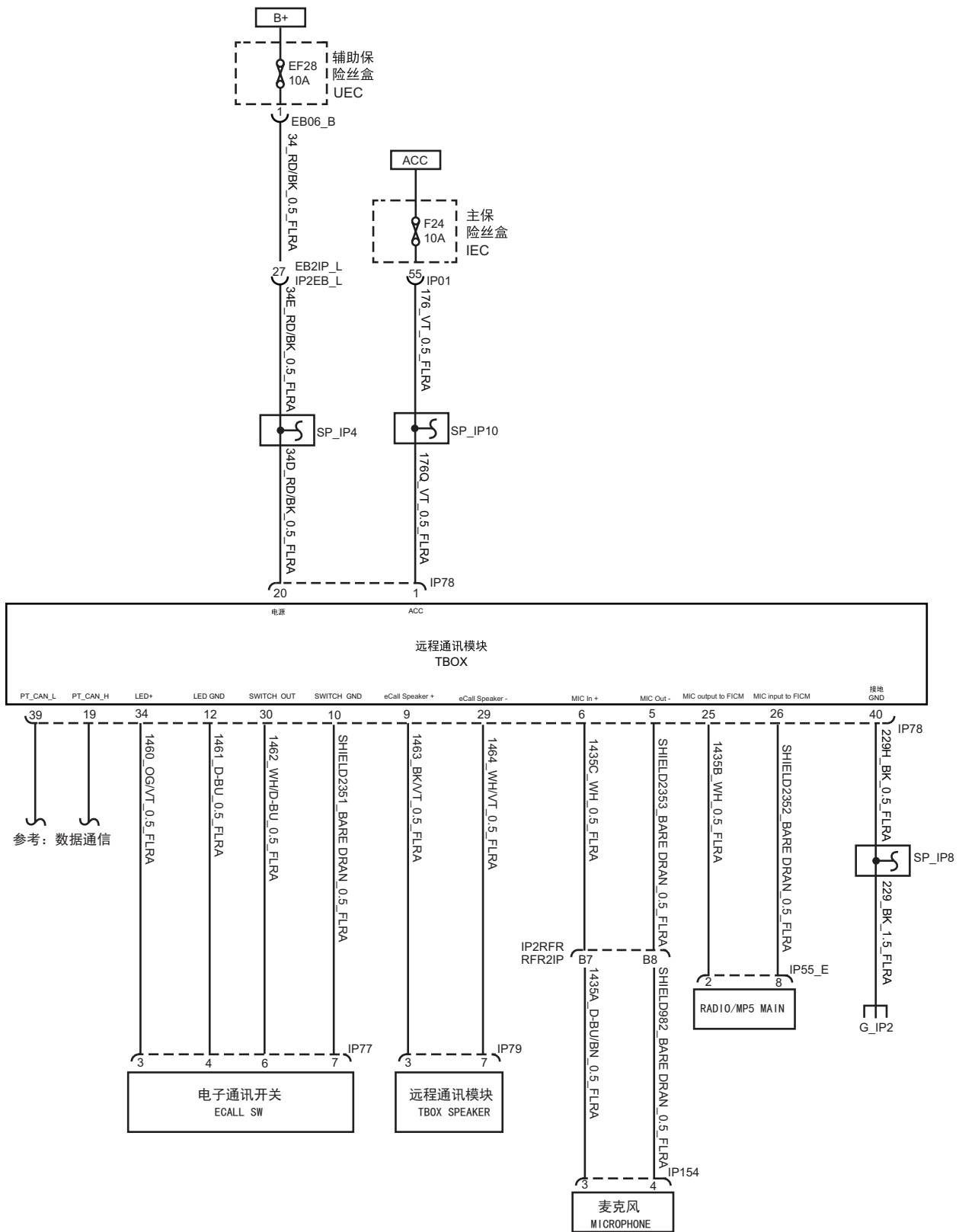

5.17 Interior lighting system

5.17.1 Interior lighting system 1 -Left Rudder

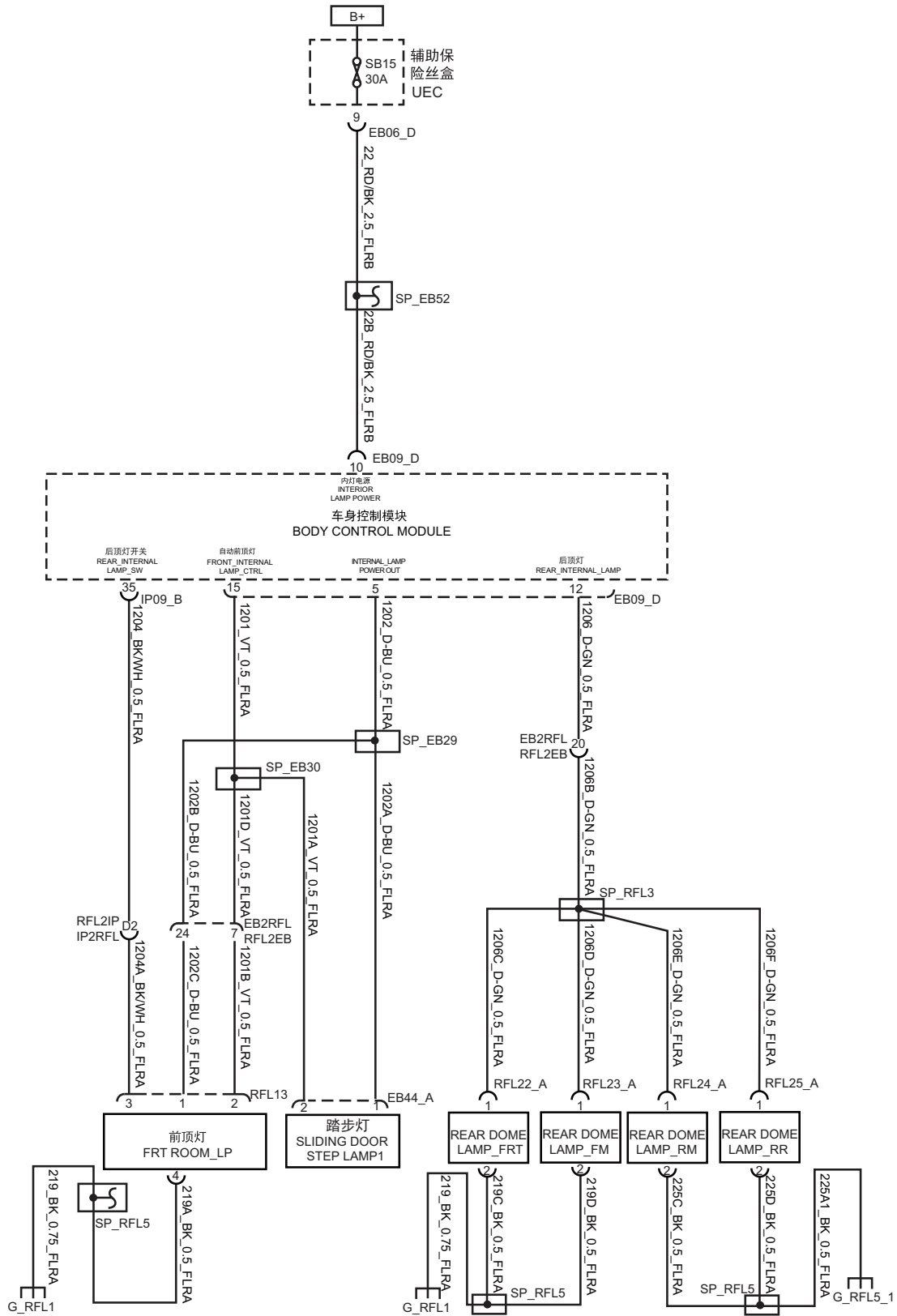

5.17.2 Interior lighting system 2 -Left Rudder

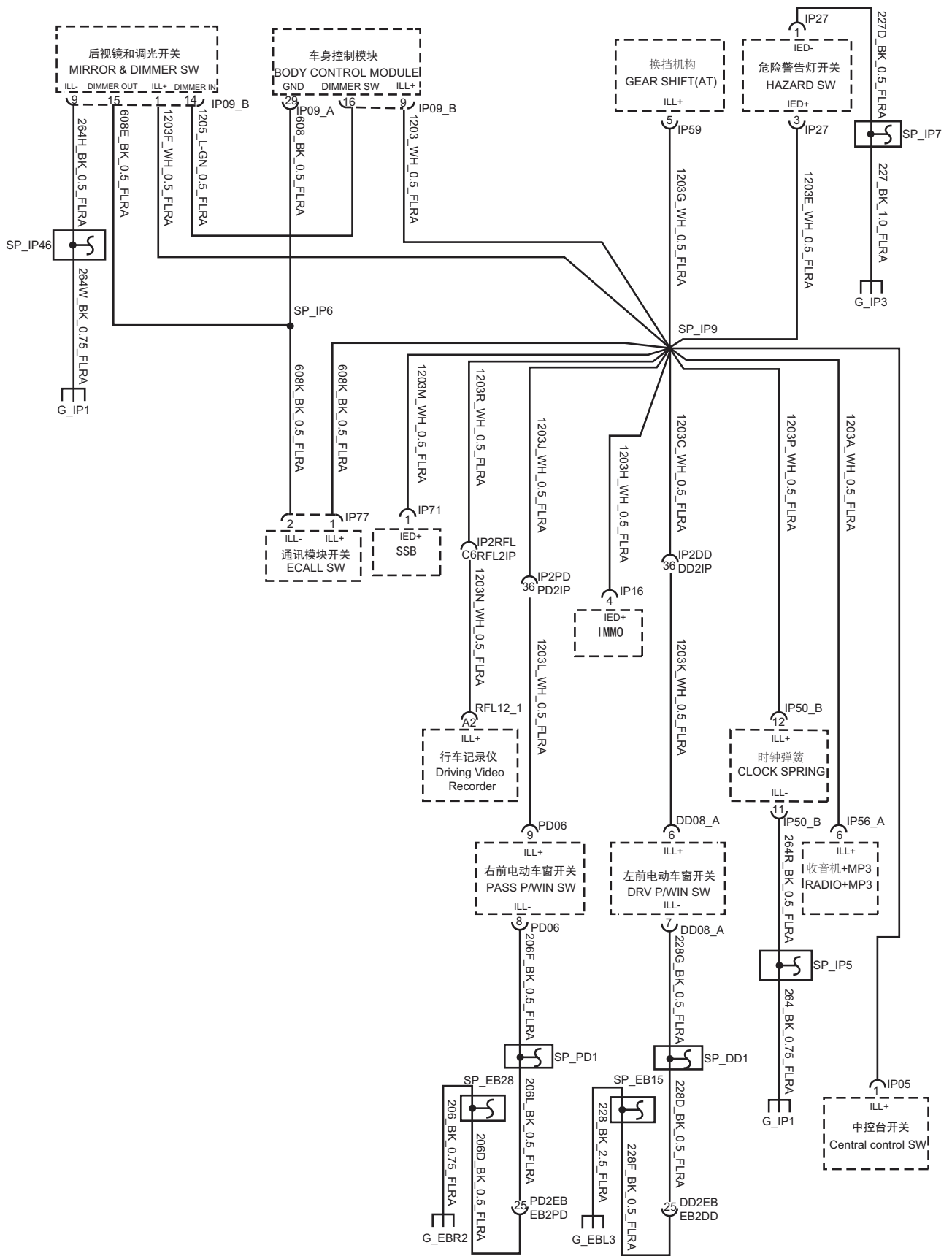

5.17.3 Interior lighting system 1 - Right Rudder

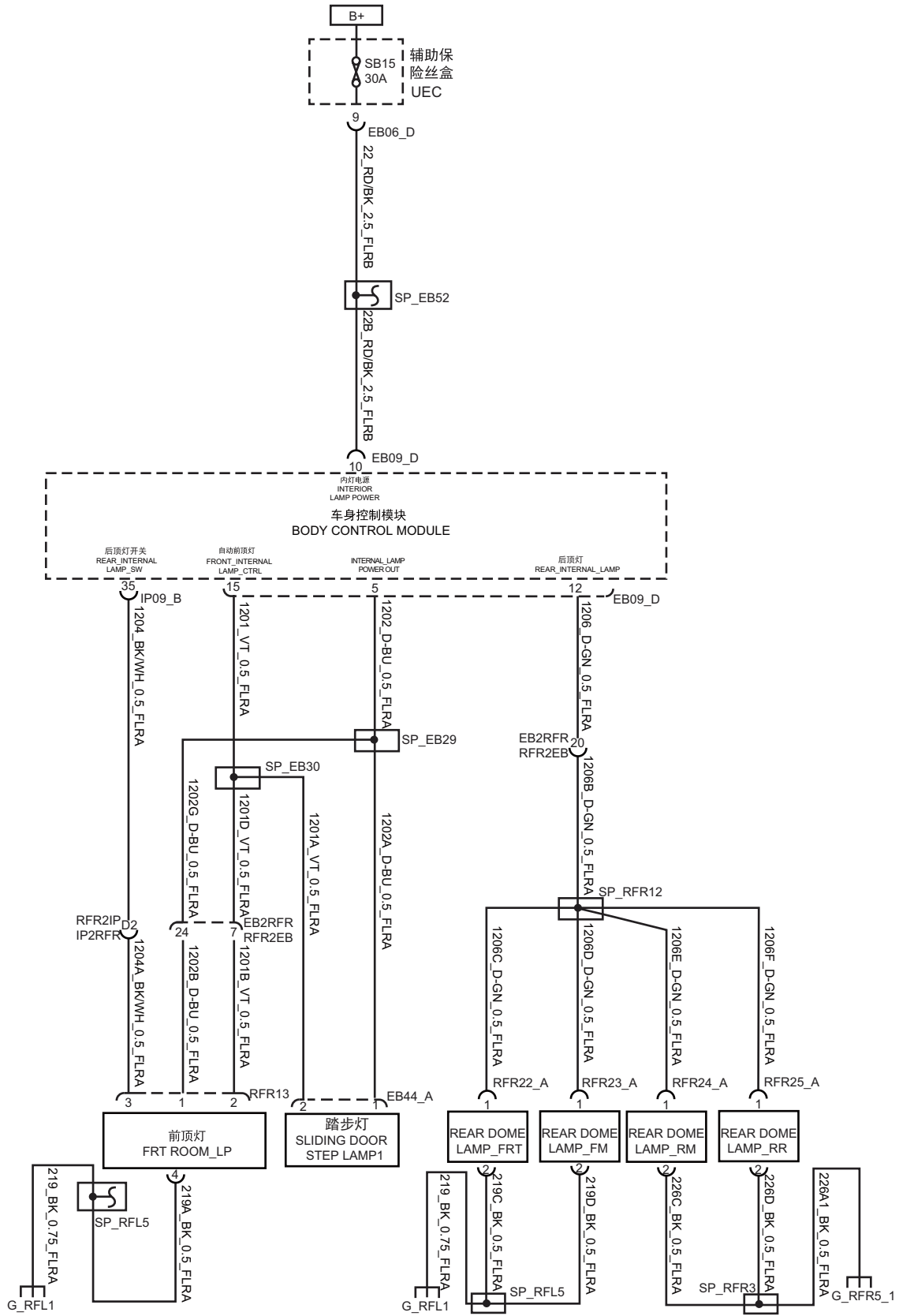

5.18 Exterior lighting system

5.18.1 Exterior lighting system 1 - Left Rudder

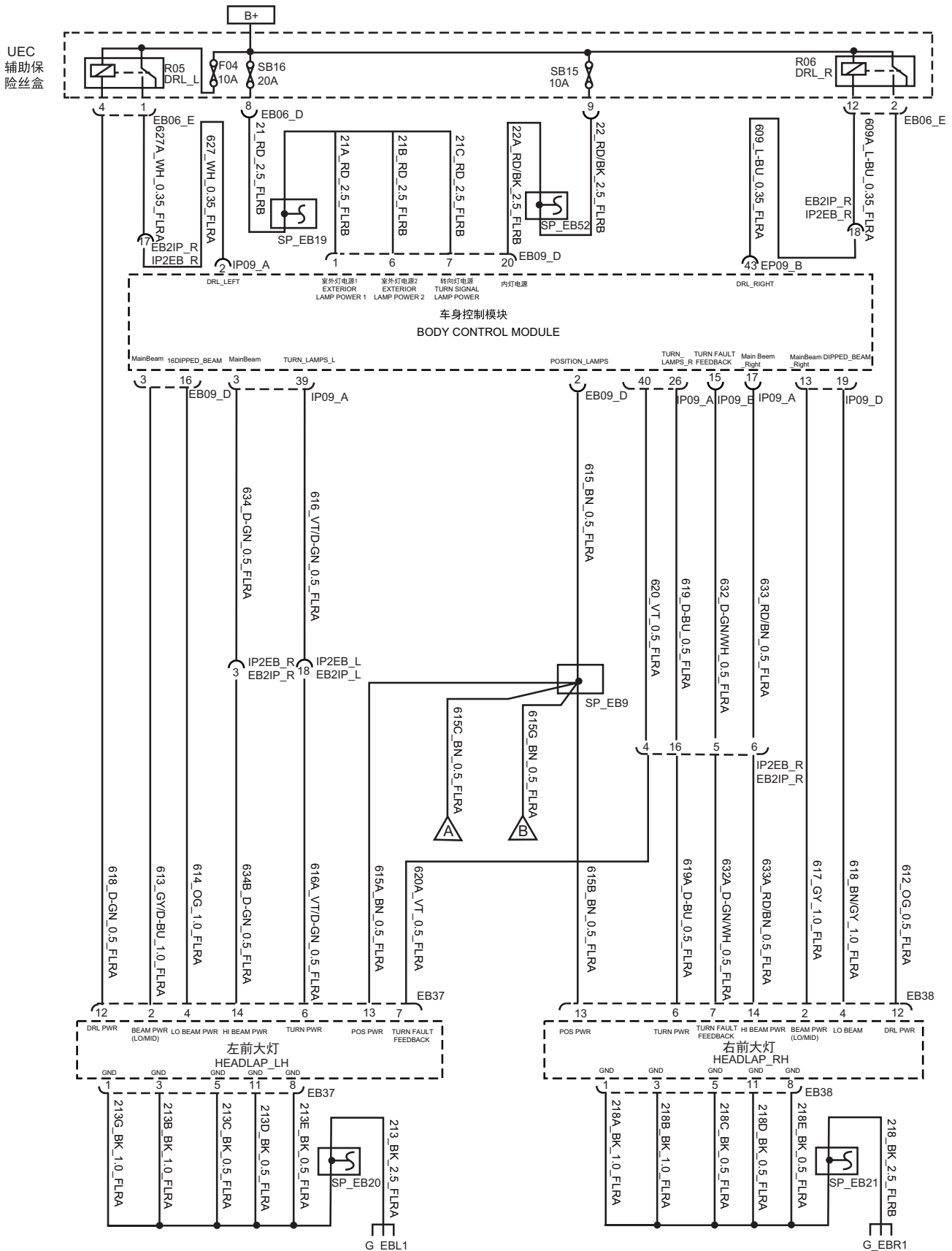

5.18.2 Exterior lighting system 2 - Left Rudder

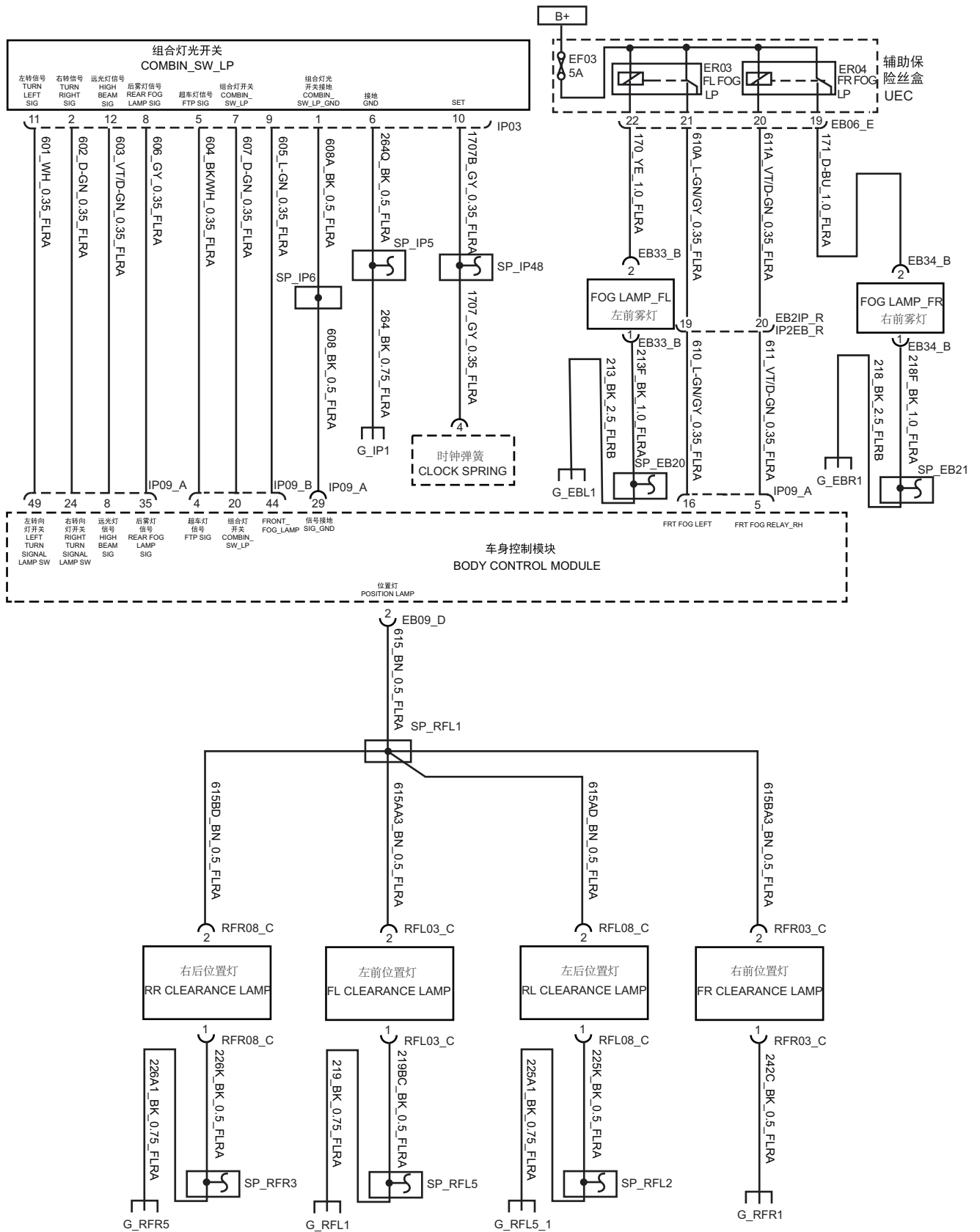

5. 18. 3 Exterior lighting system 3 - Left Rudder

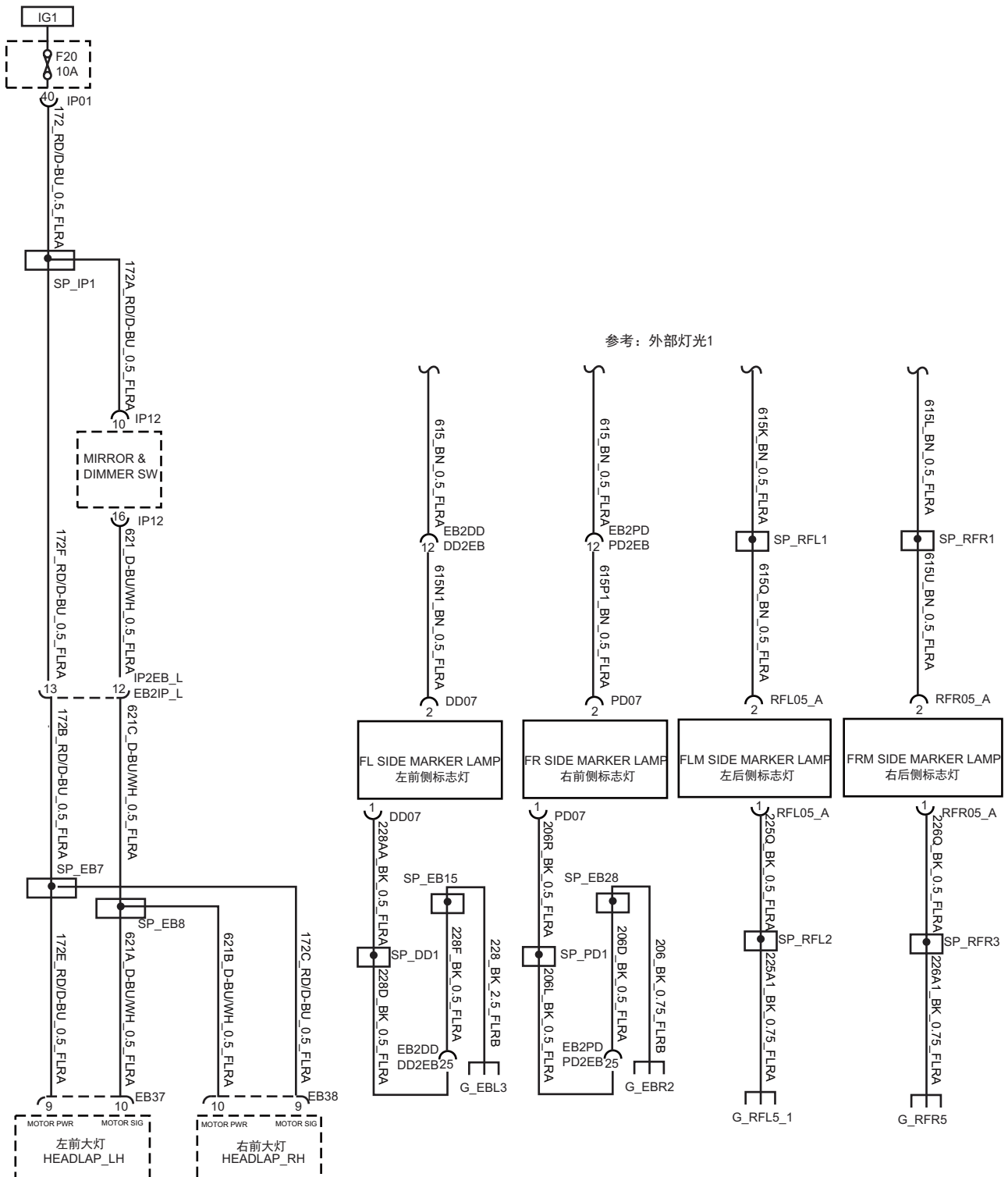

5.18.4 Exterior lighting system 4(1405) - Left Rudder

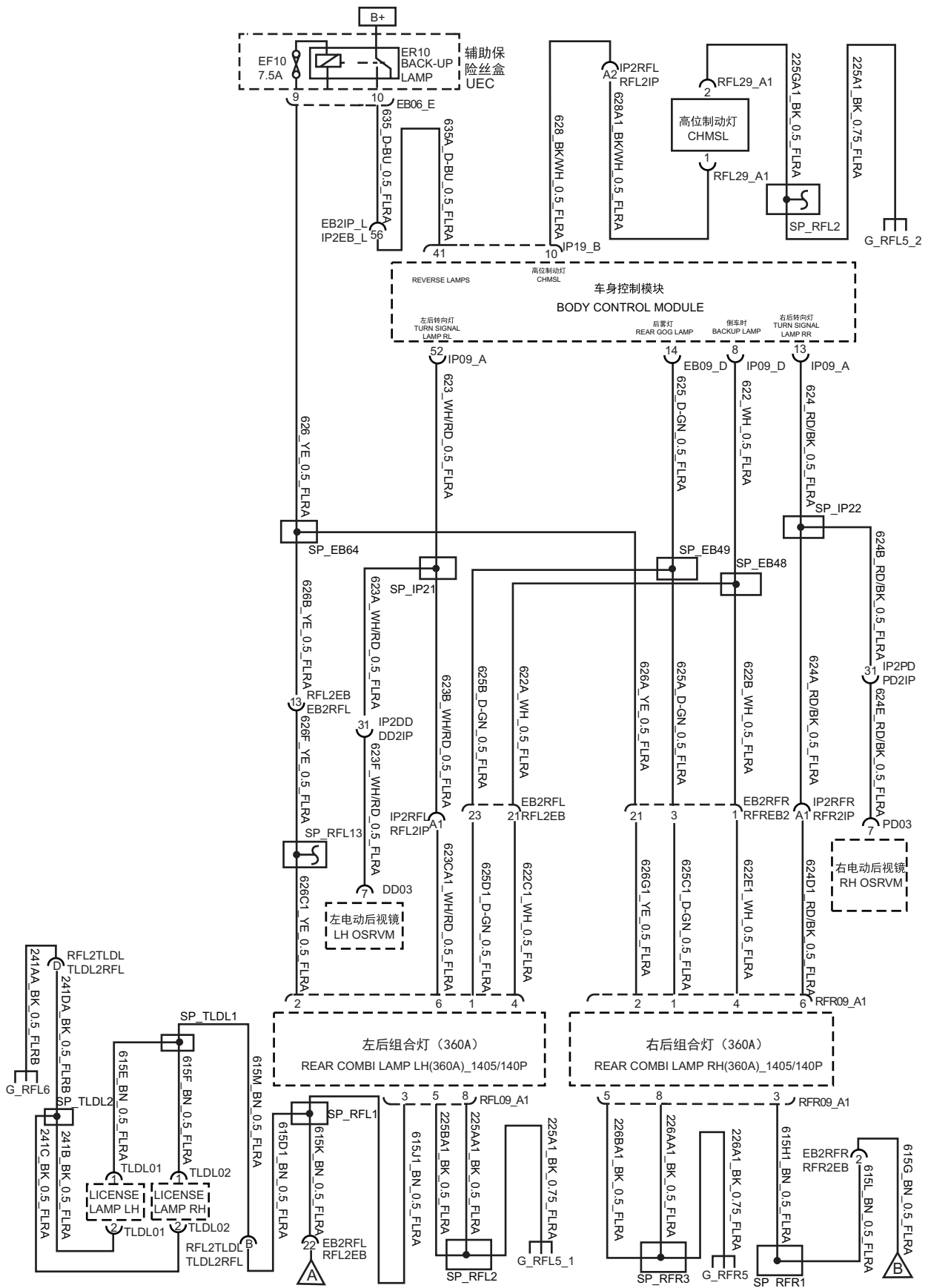

5. 18. 5 Exterior lighting system 4(1406, 1409) - Left Rudder

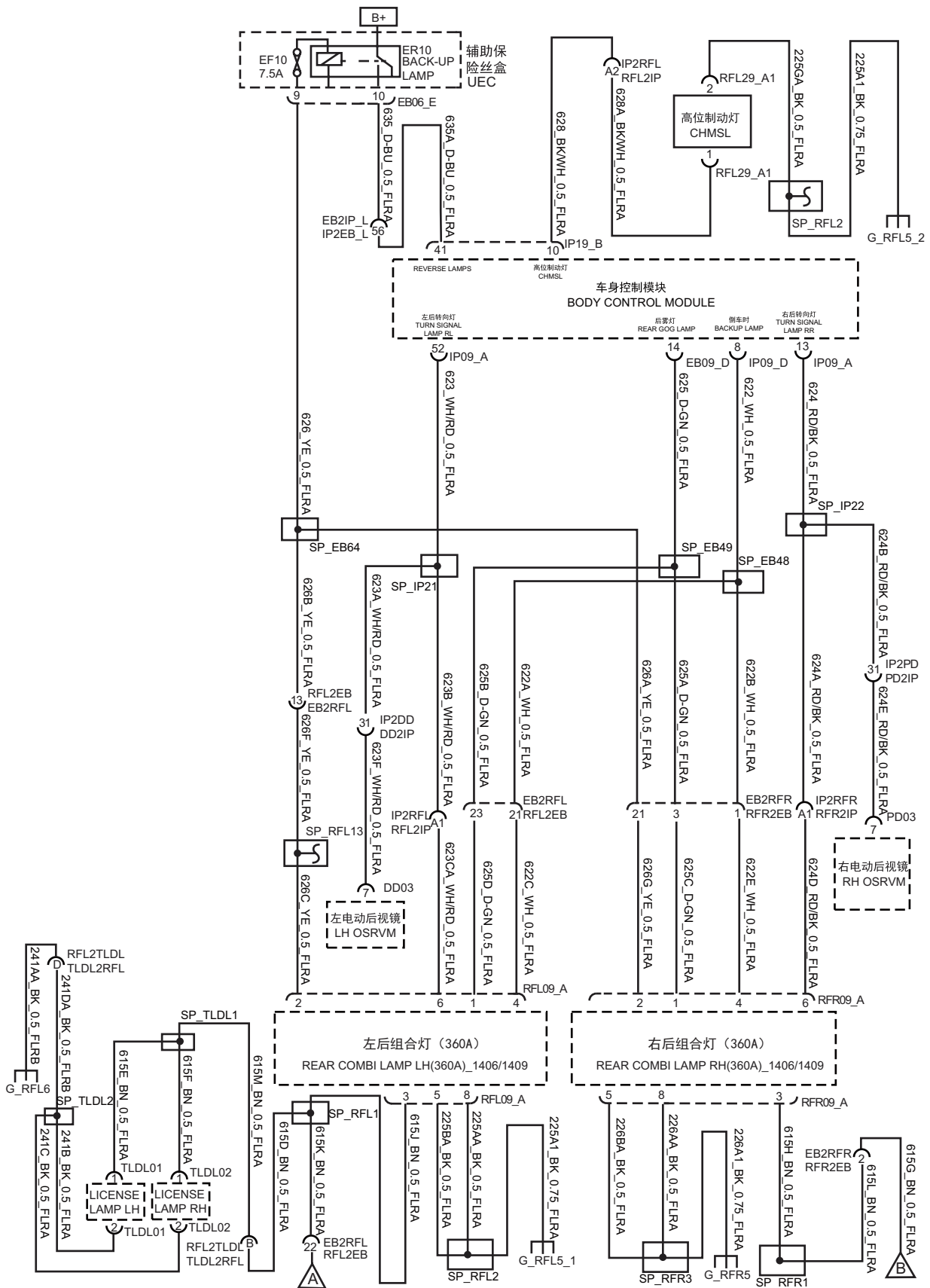

5.18.6 Exterior lighting system 4 (CAB) - Left Rudder

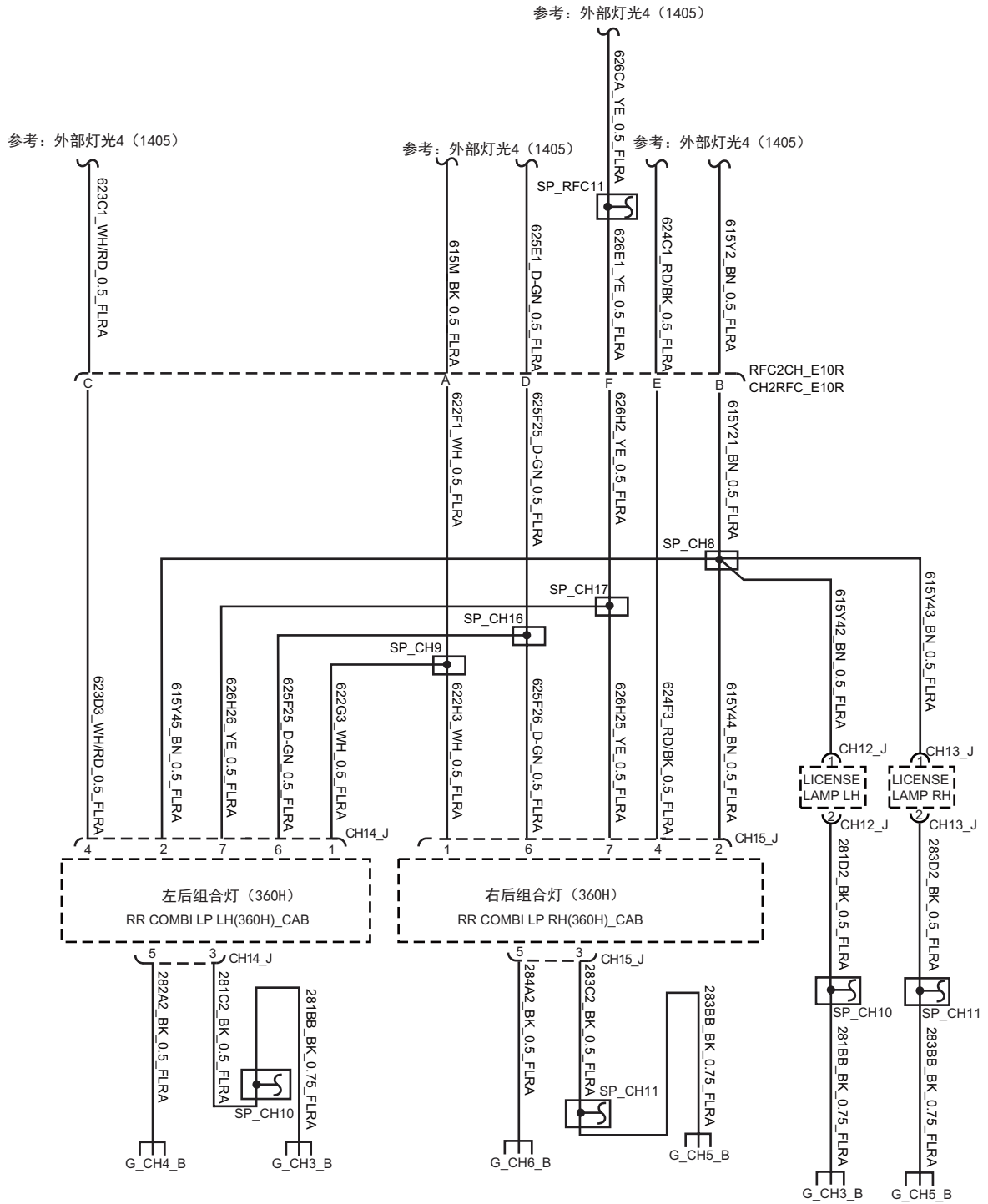

5. 18. 7 Exterior lighting system 1 - Right Rudder

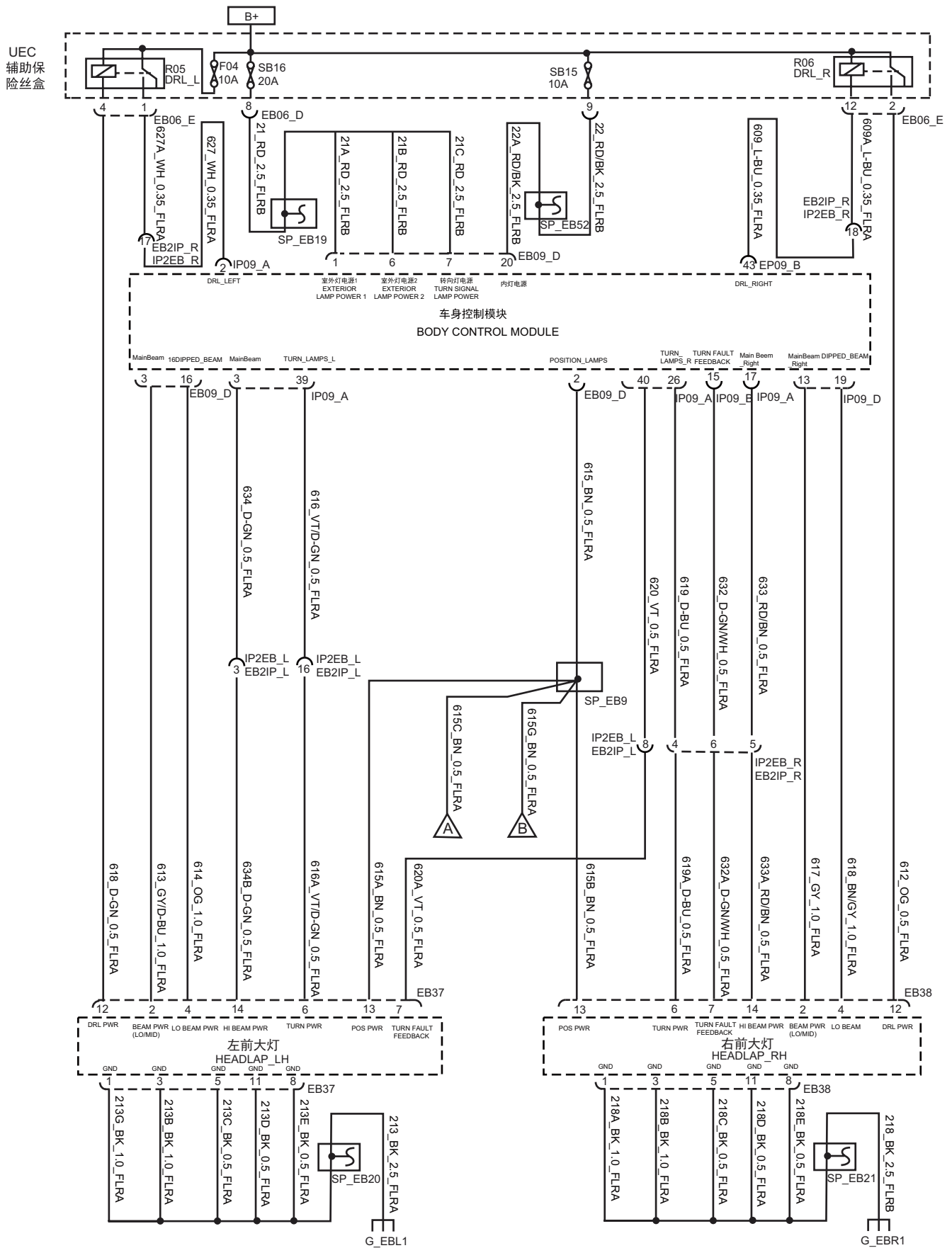

5.18.8 Exterior lighting system 2 – Right Rudder

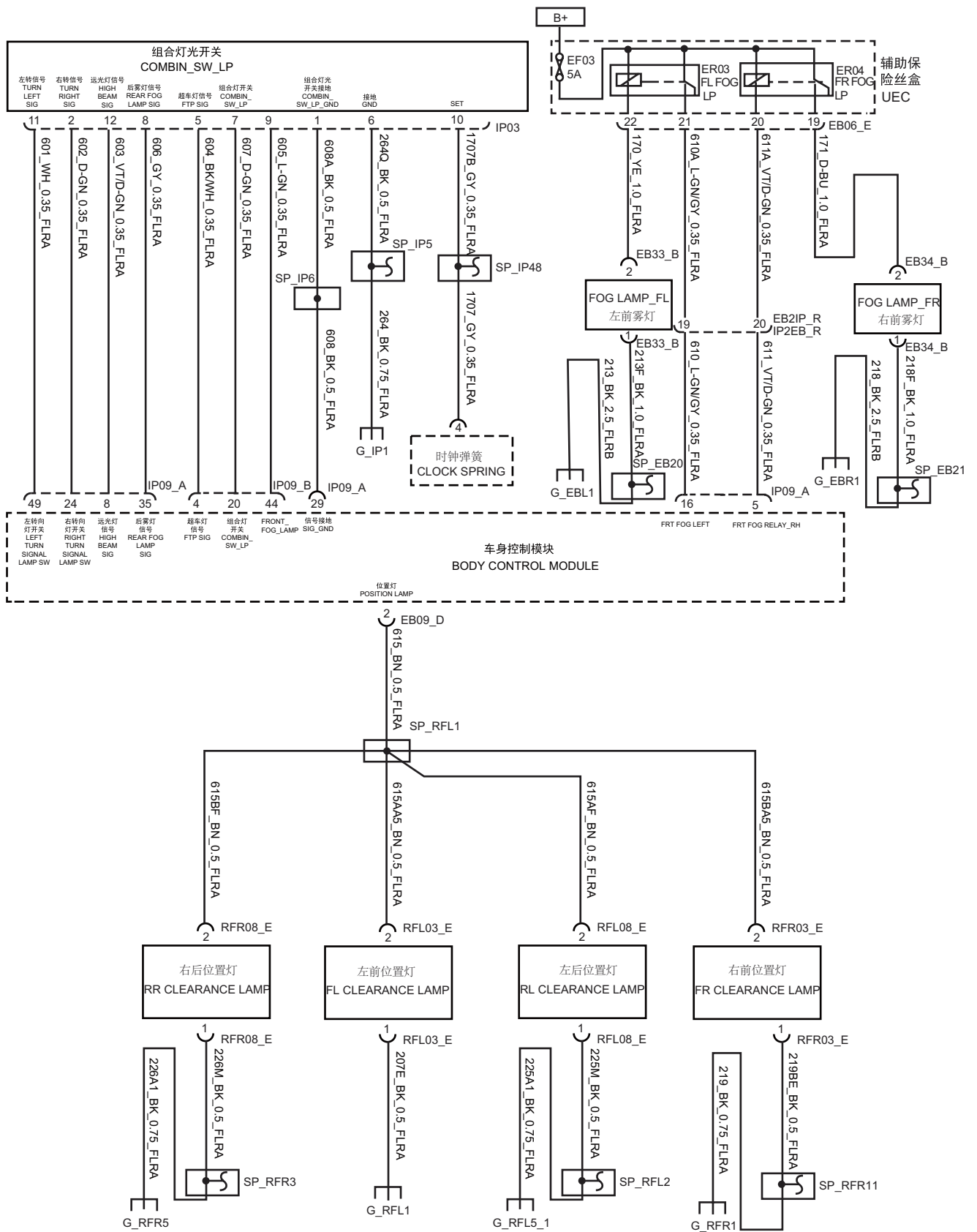

5. 18. 9 Exterior lighting system 3 - Right Rudder

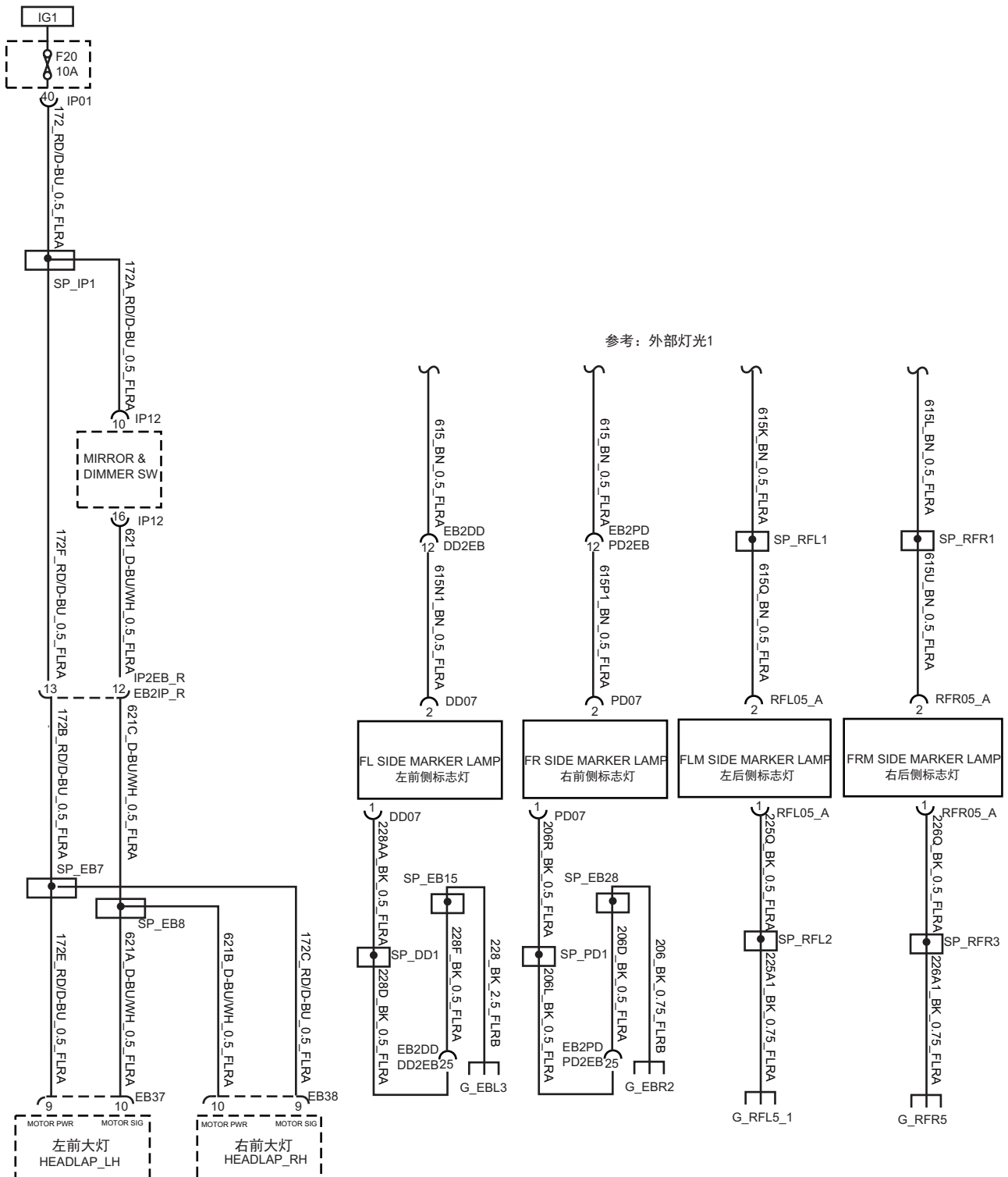

5.18.10 Exterior lighting system 4(1405) - Right Rudder

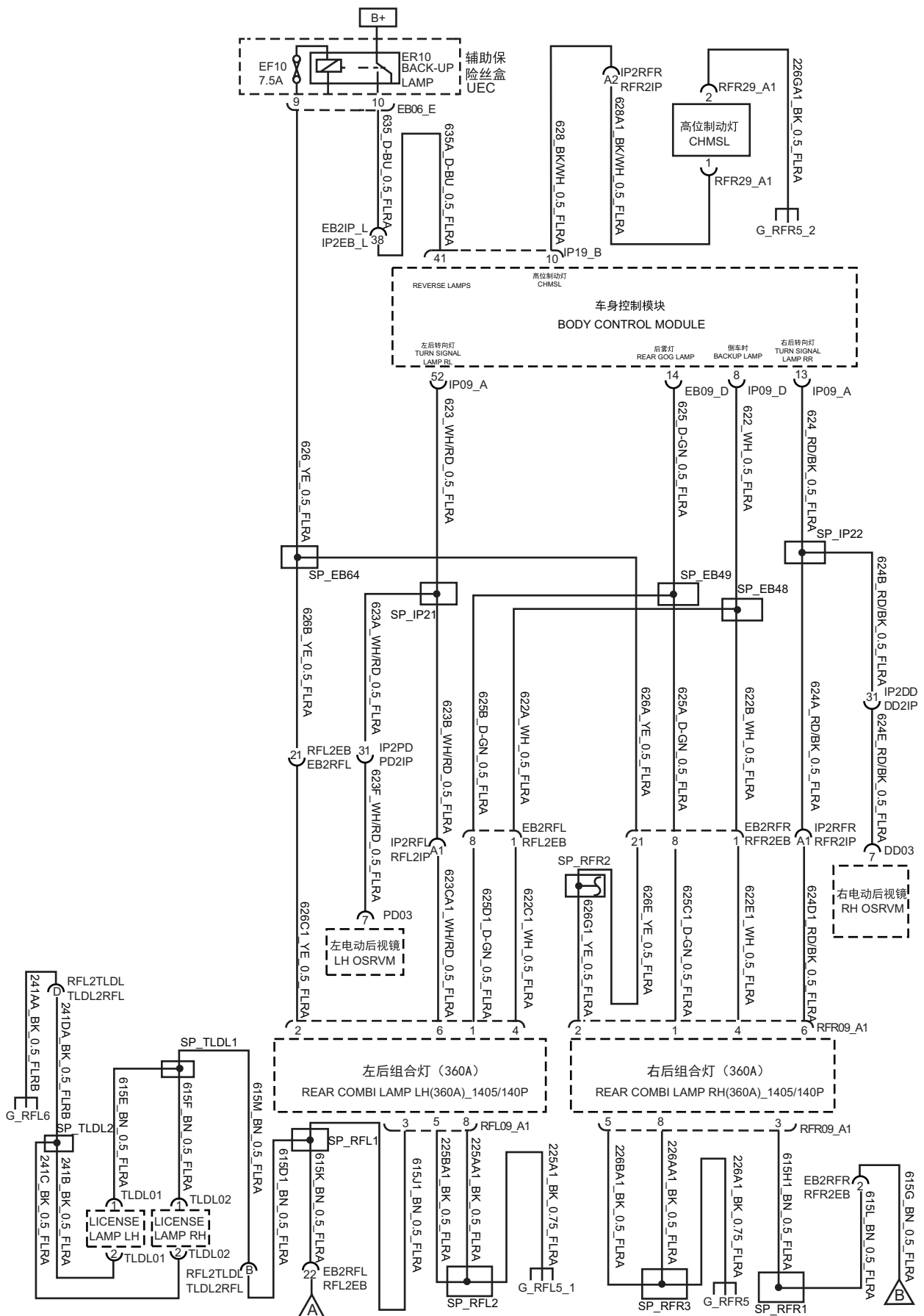

5.18.11 Exterior lighting system 4(1406, 1409) - Right Rudder

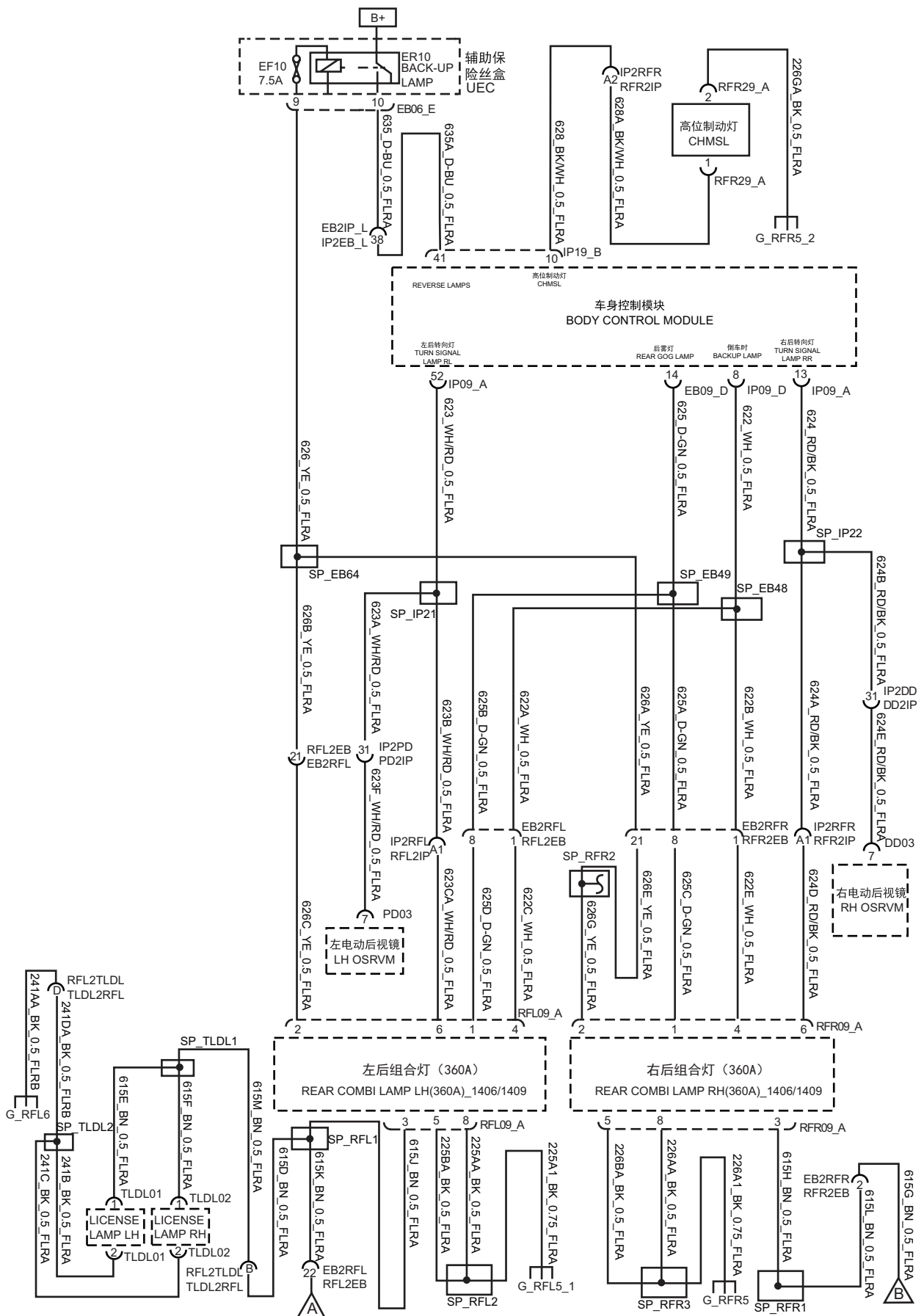

5.18.12 Exterior lighting system 4(CAB) - Right Rudder

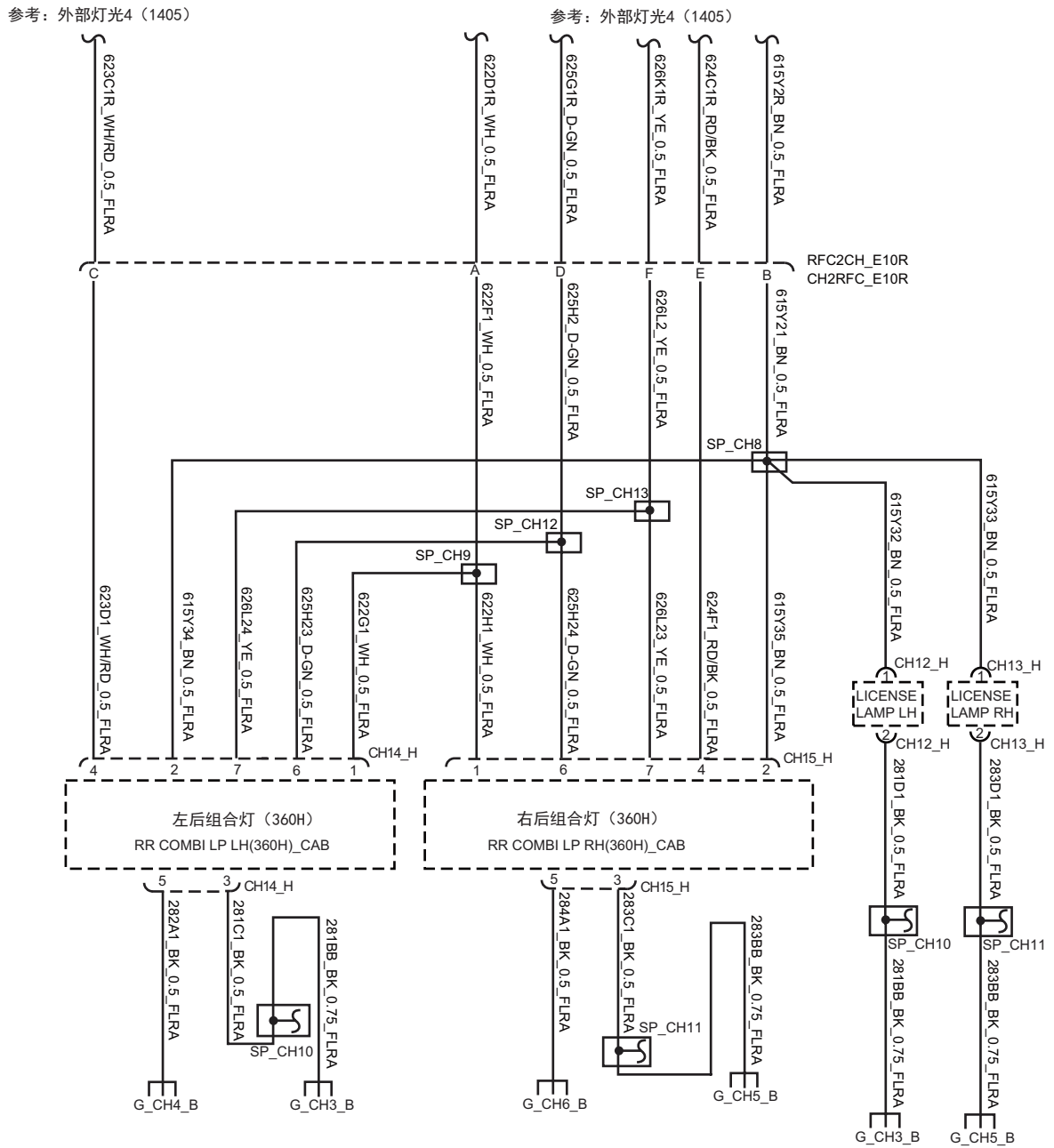

5.19 Vehicle safety system

5.19.1 Vehicle safety system 1 - Left Rudder

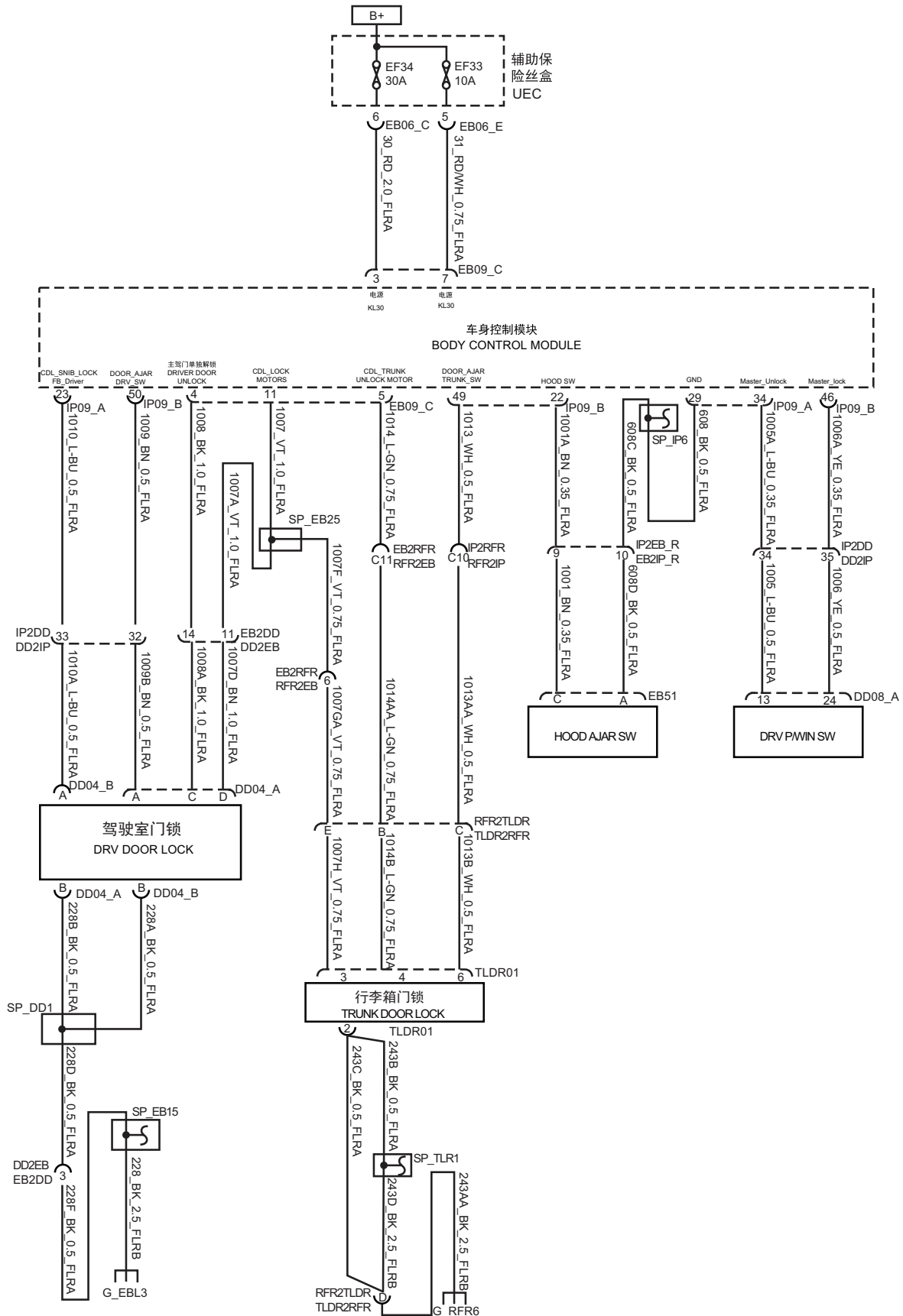

5.19.2 Vehicle safety system 2 - Left Rudder

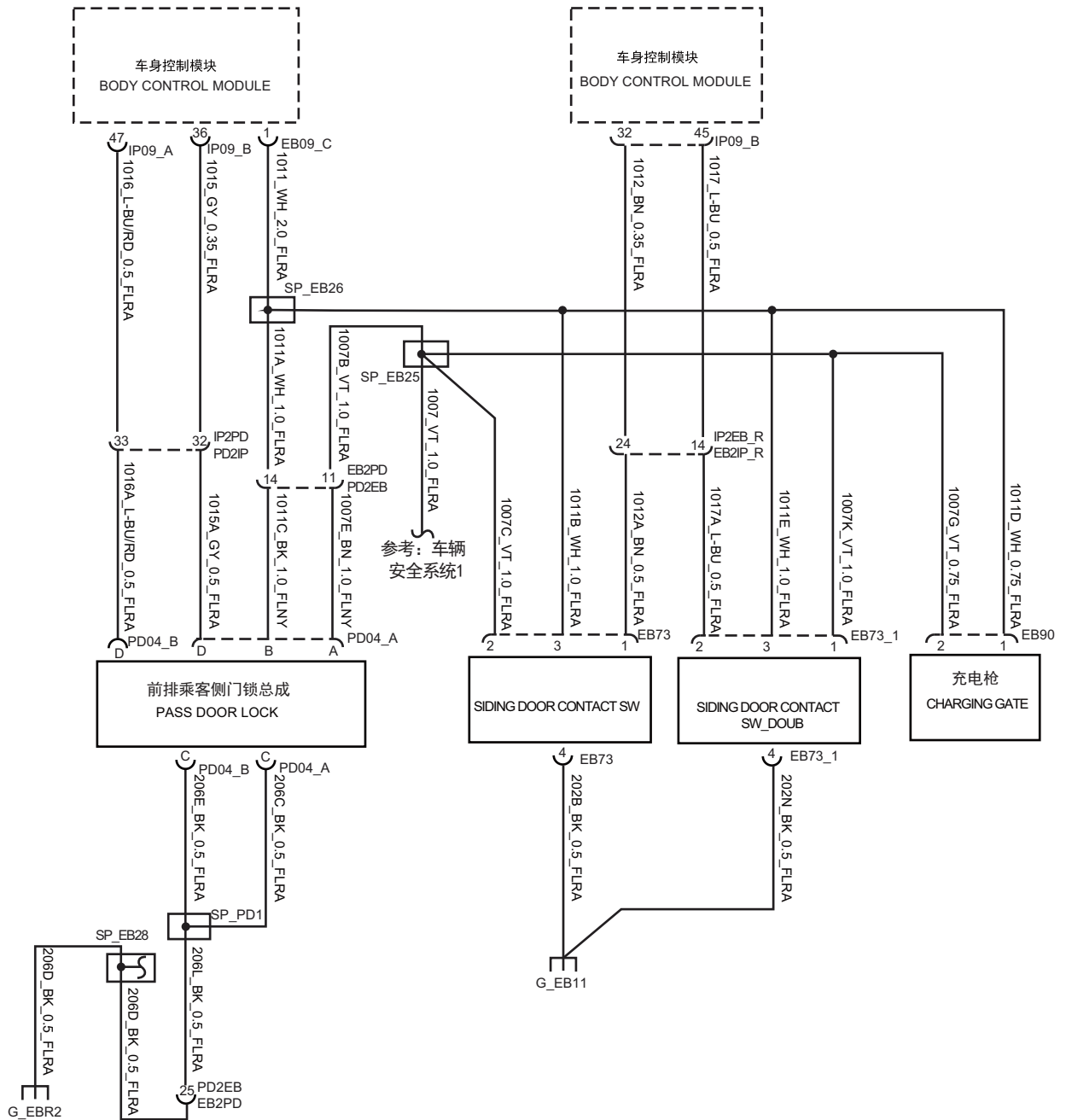

5.19.4 Vehicle safety system 2 – Right Rudder

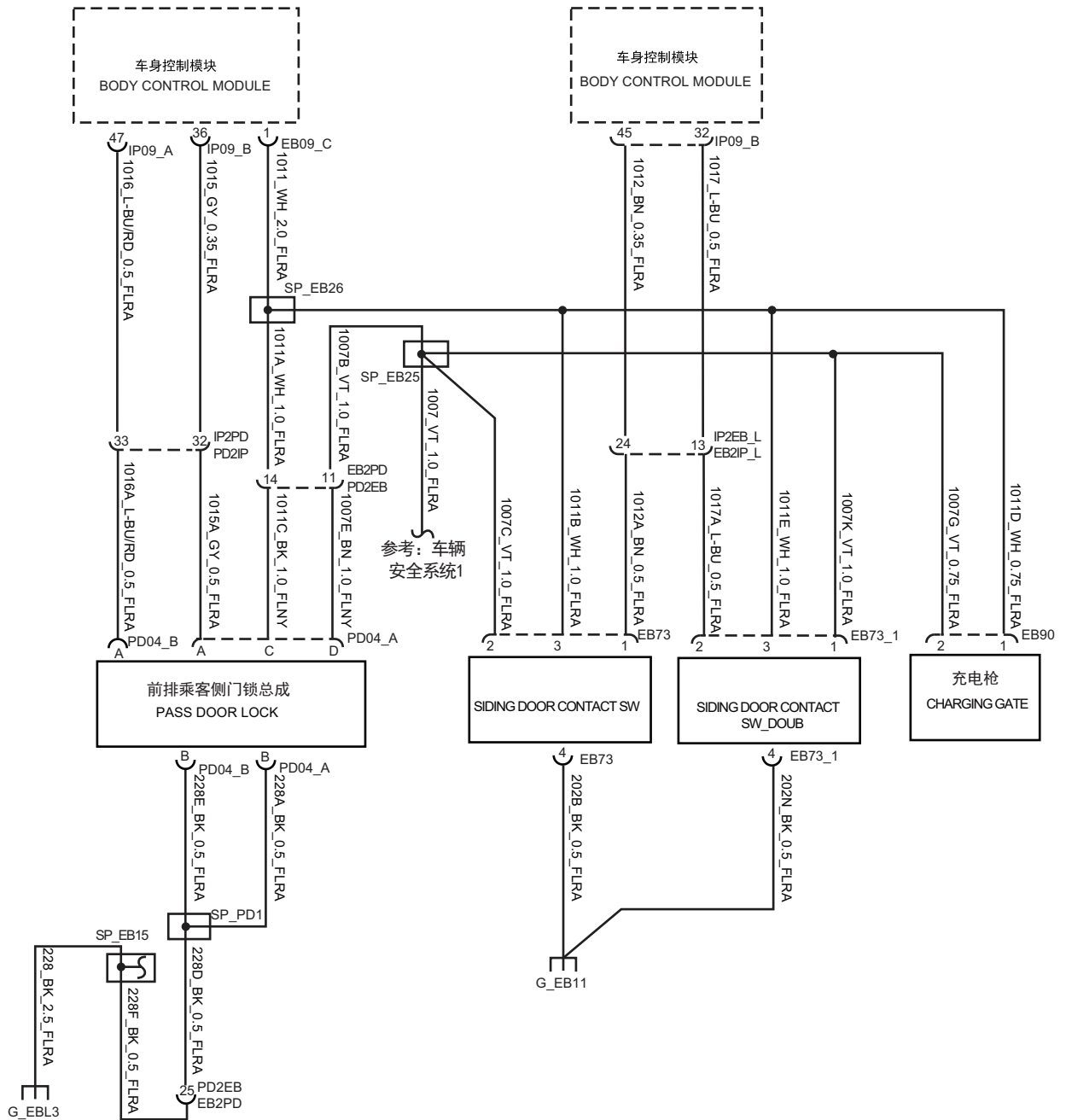

5.20 ADAS system

5.20.1 ADAS system - Left Rudder

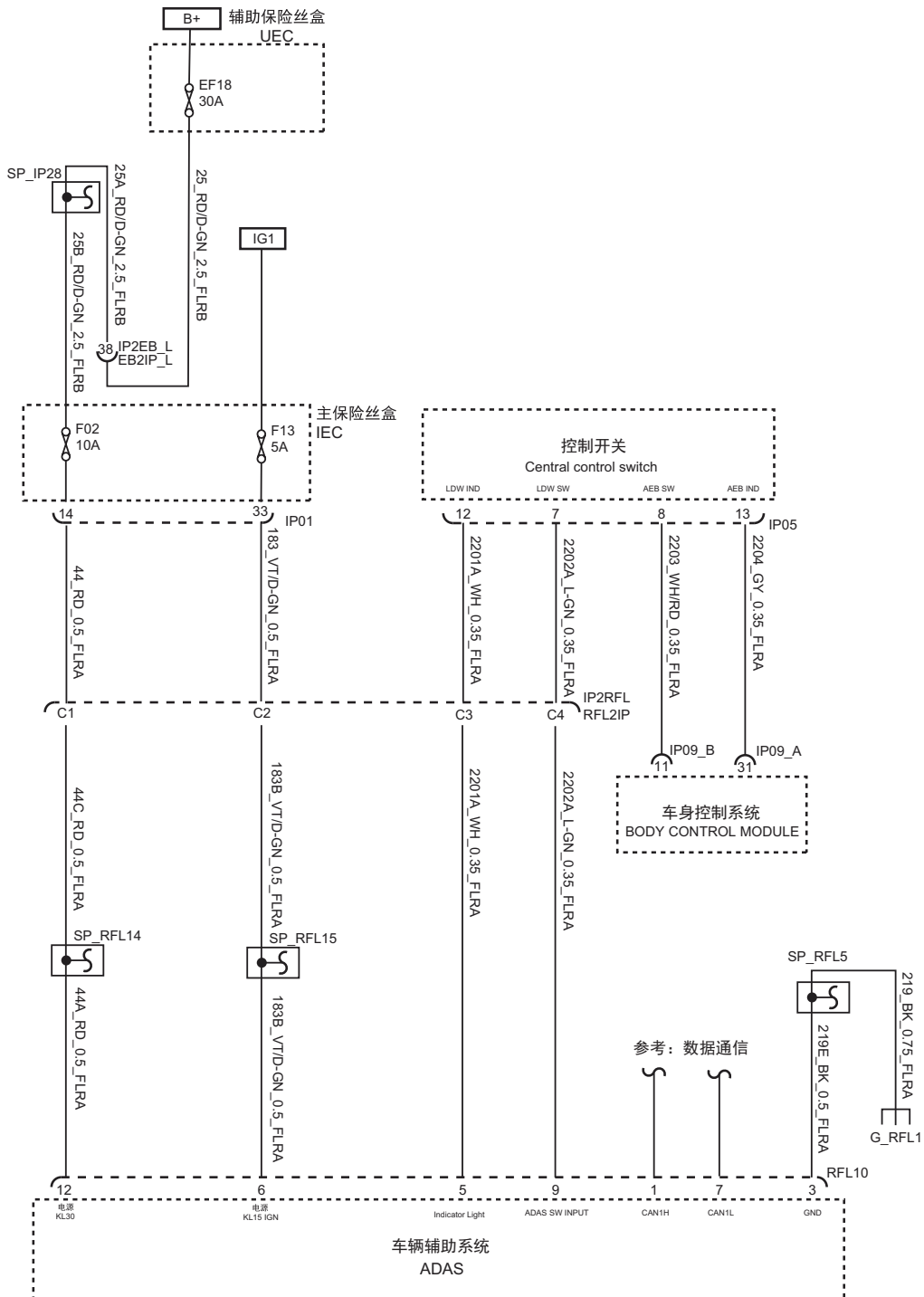

5. 20. 2 ADAS system – Right Rudder

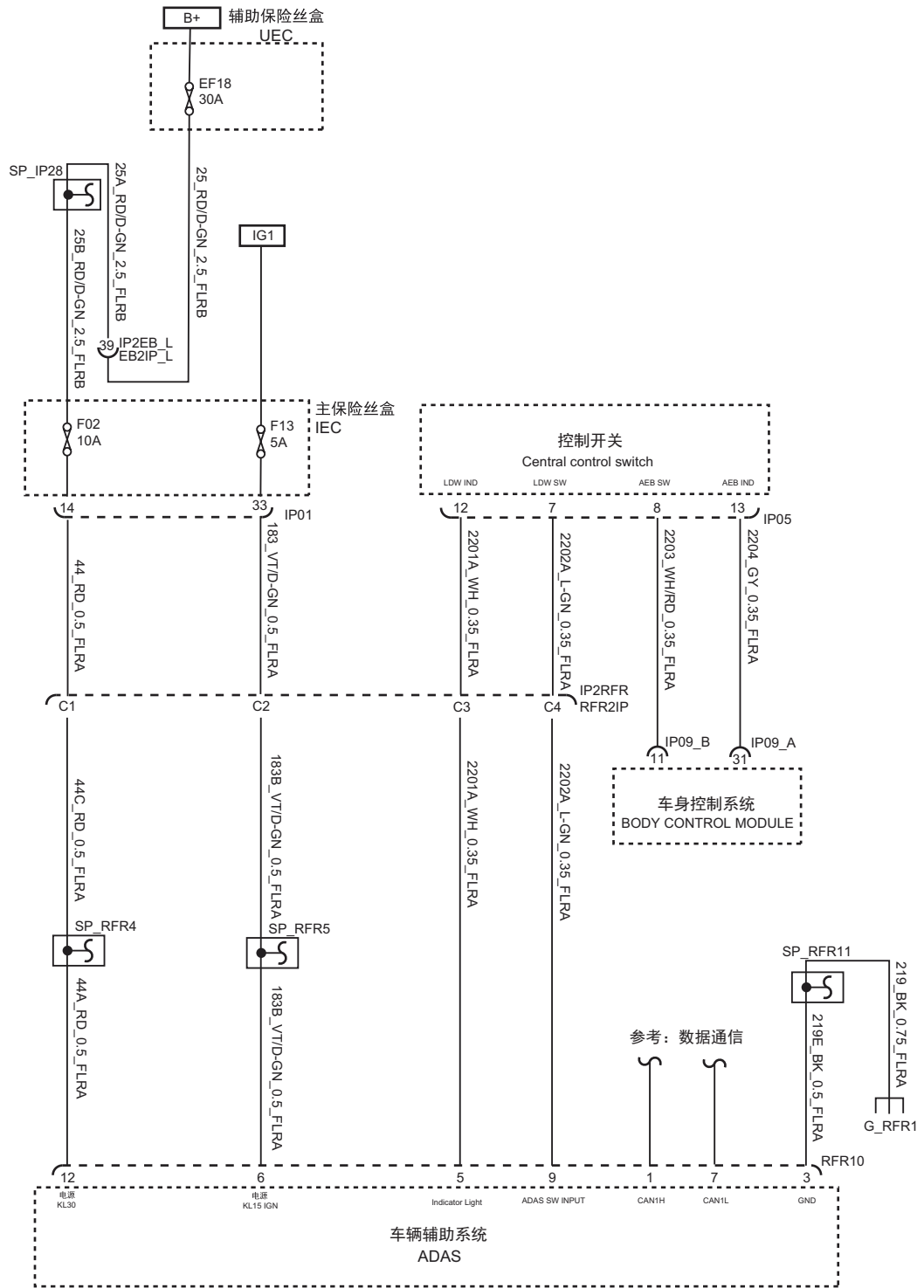

5.21 Vehicle Control System

5.21.1 Vehicle Control System 1 - Left Rudder

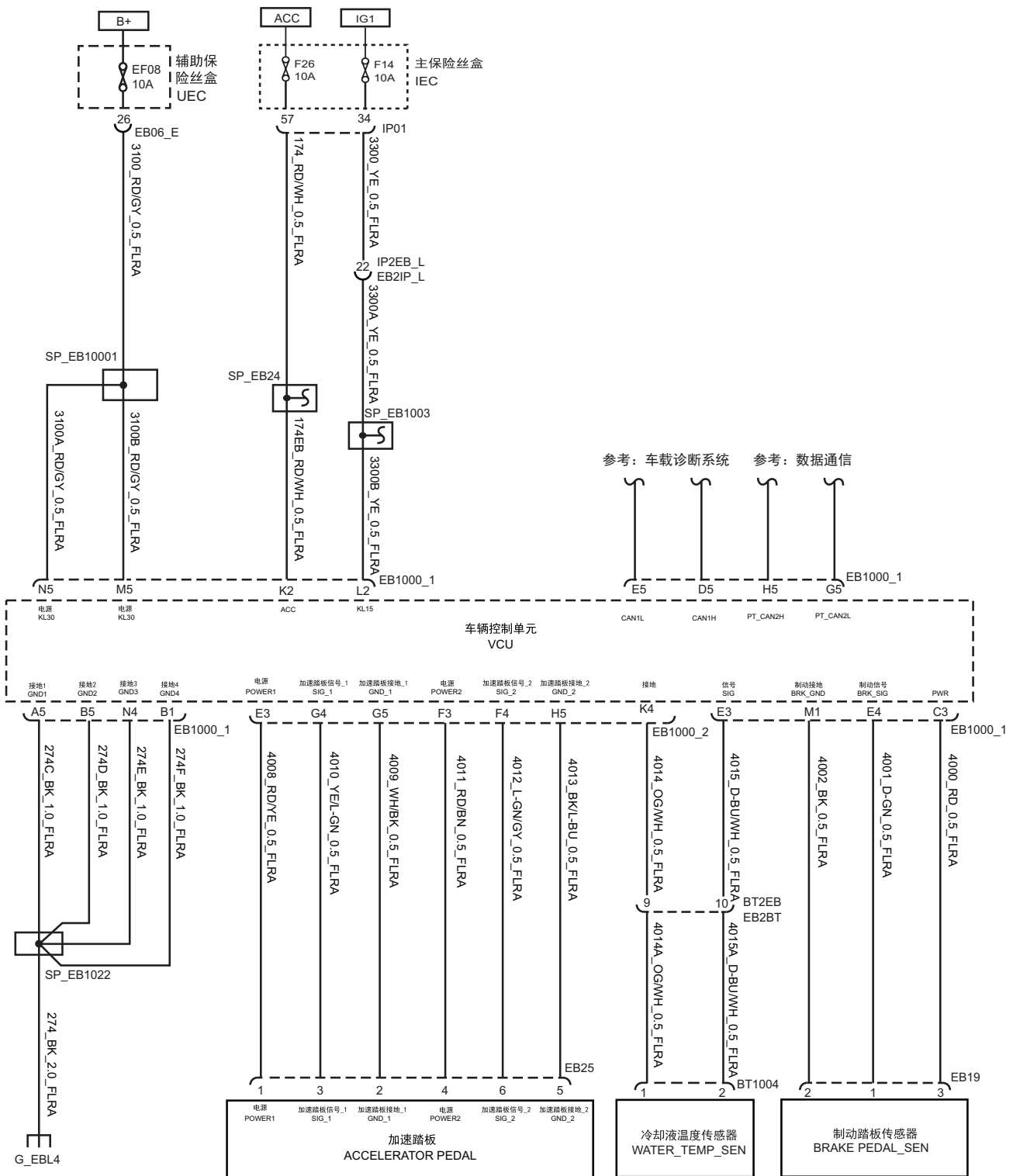

5.21.2 Vehicle Control System 2 - Left Rudder

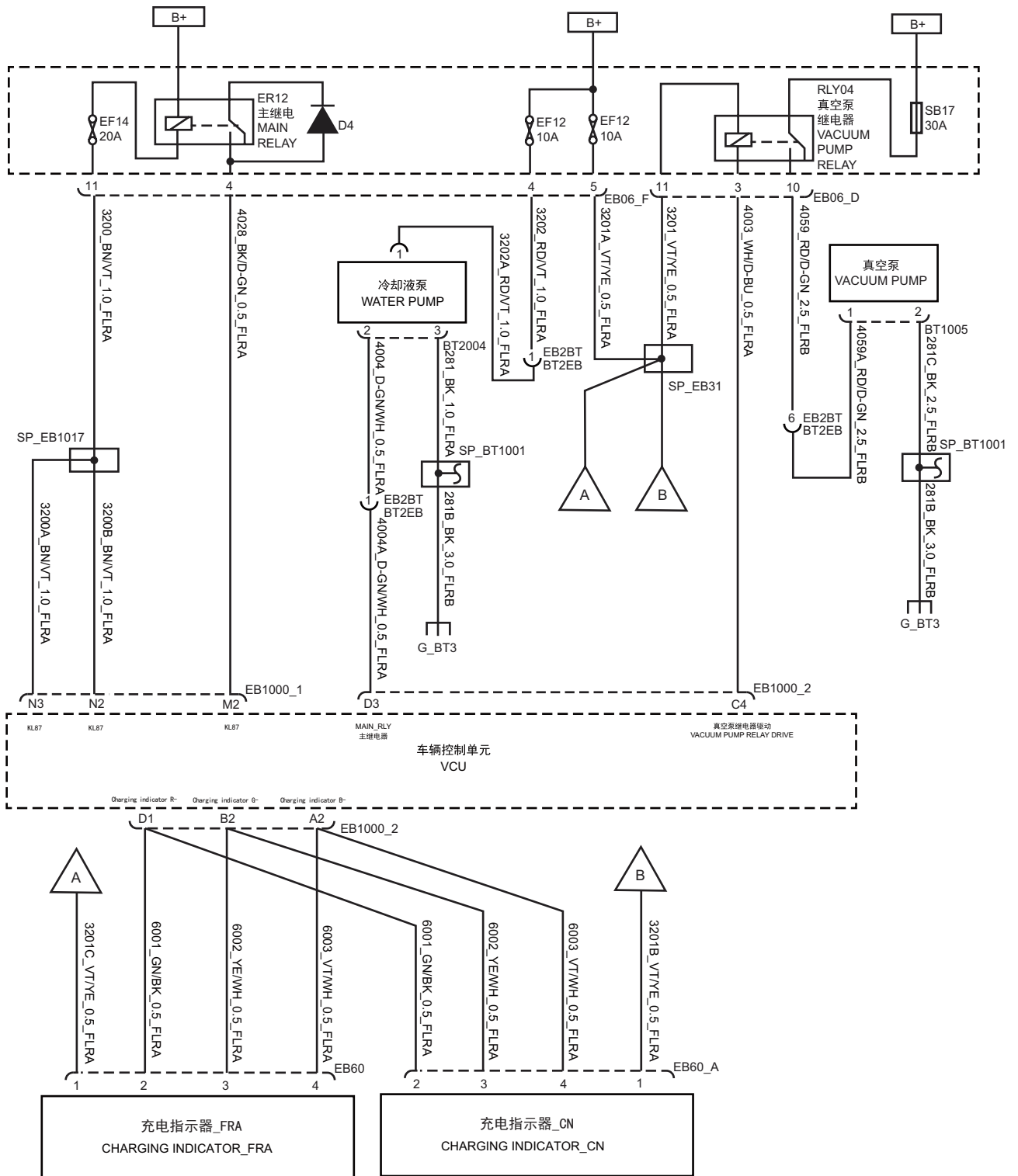

5.21.3 Vehicle Control System 3 – Left Rudder

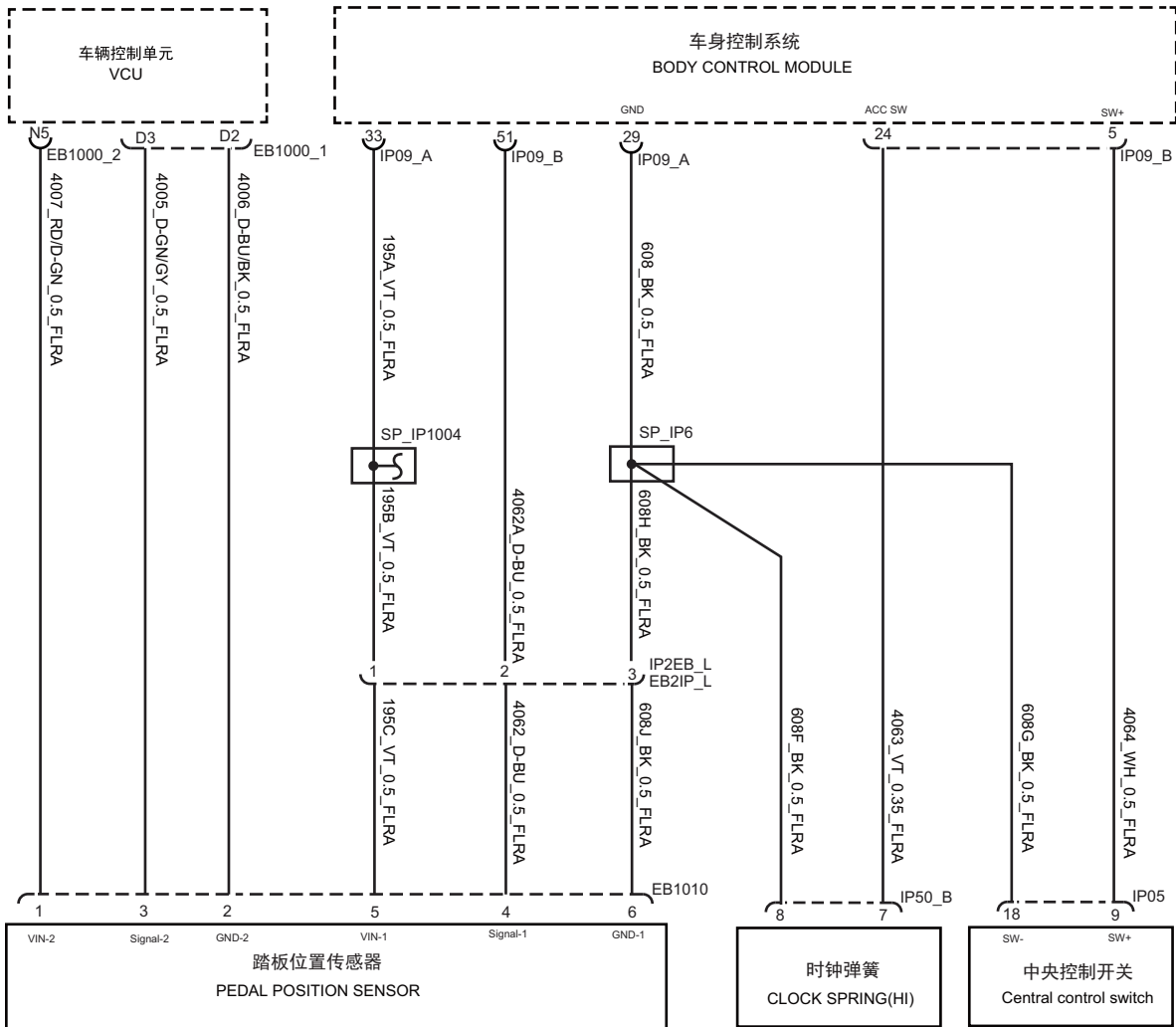

5.21.4 Vehicle Control System 1 - Right Rudder

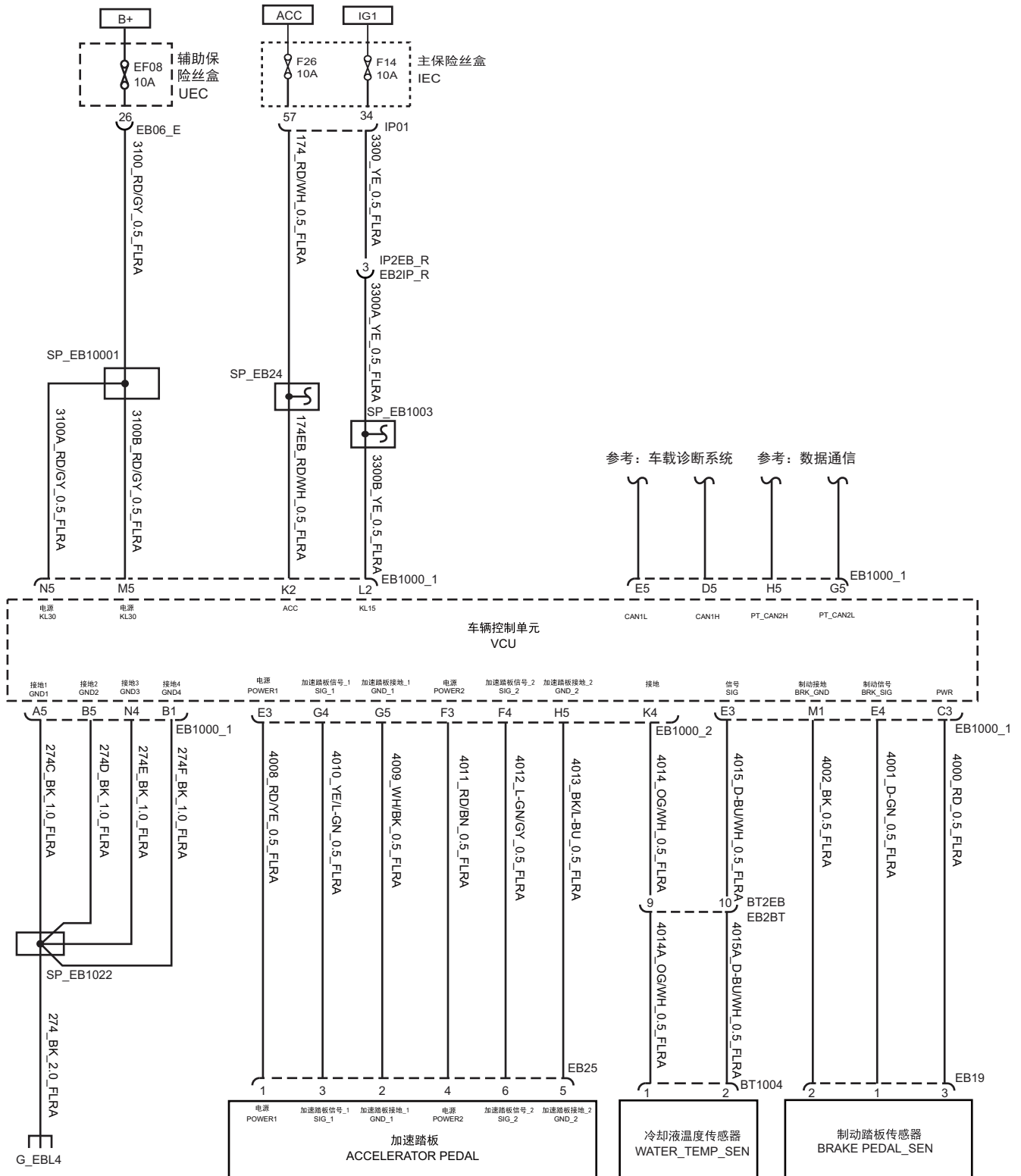

5.21.5 Vehicle Control System 2 – Right Rudder

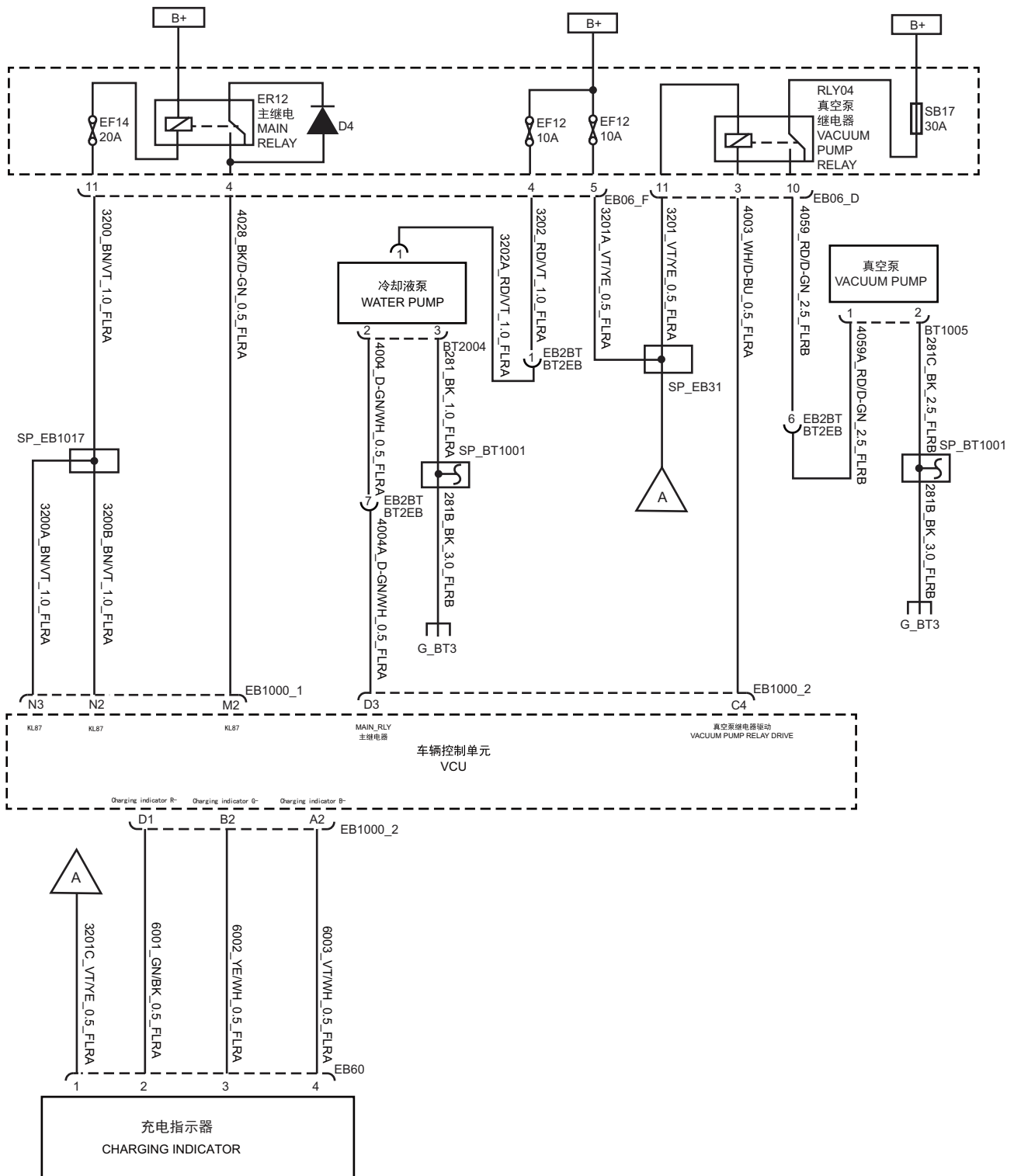

5.21.6 Vehicle Control System 3 – Right Rudder

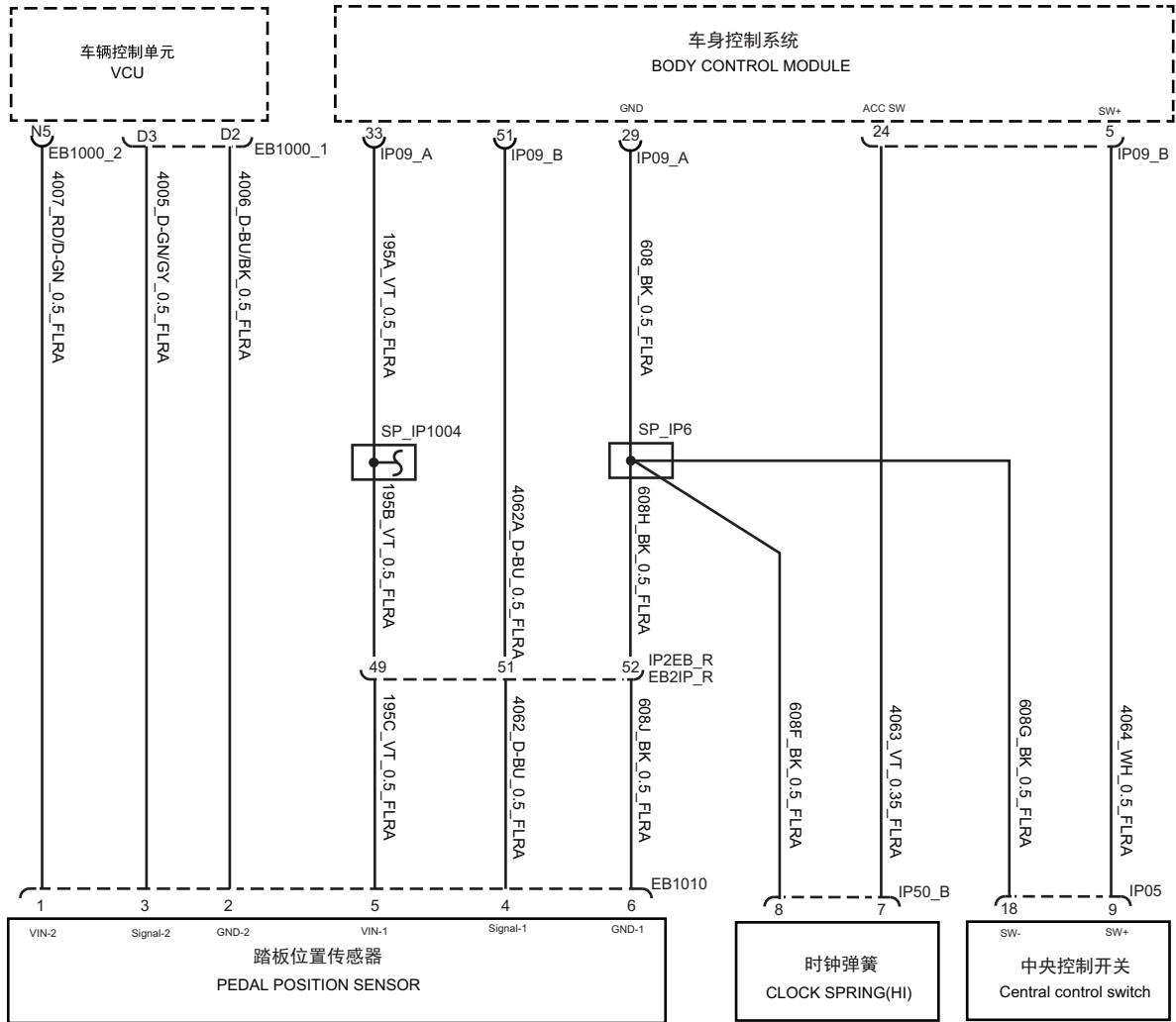

5.22 On-board diagnostic system

5.22.1 On-board diagnostic system - Left Rudder

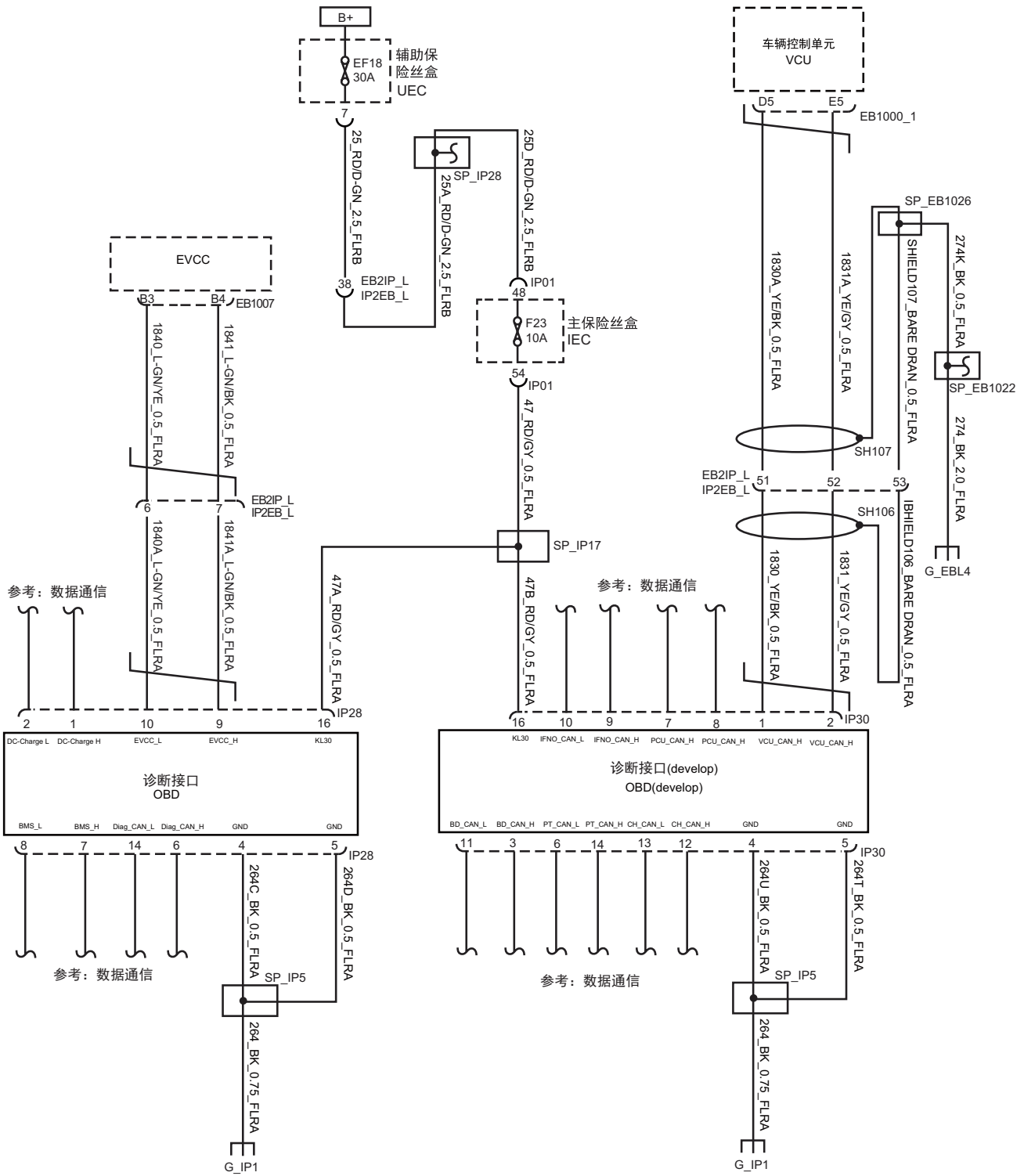

5.22.2 On-board diagnostic system – Right Rudder

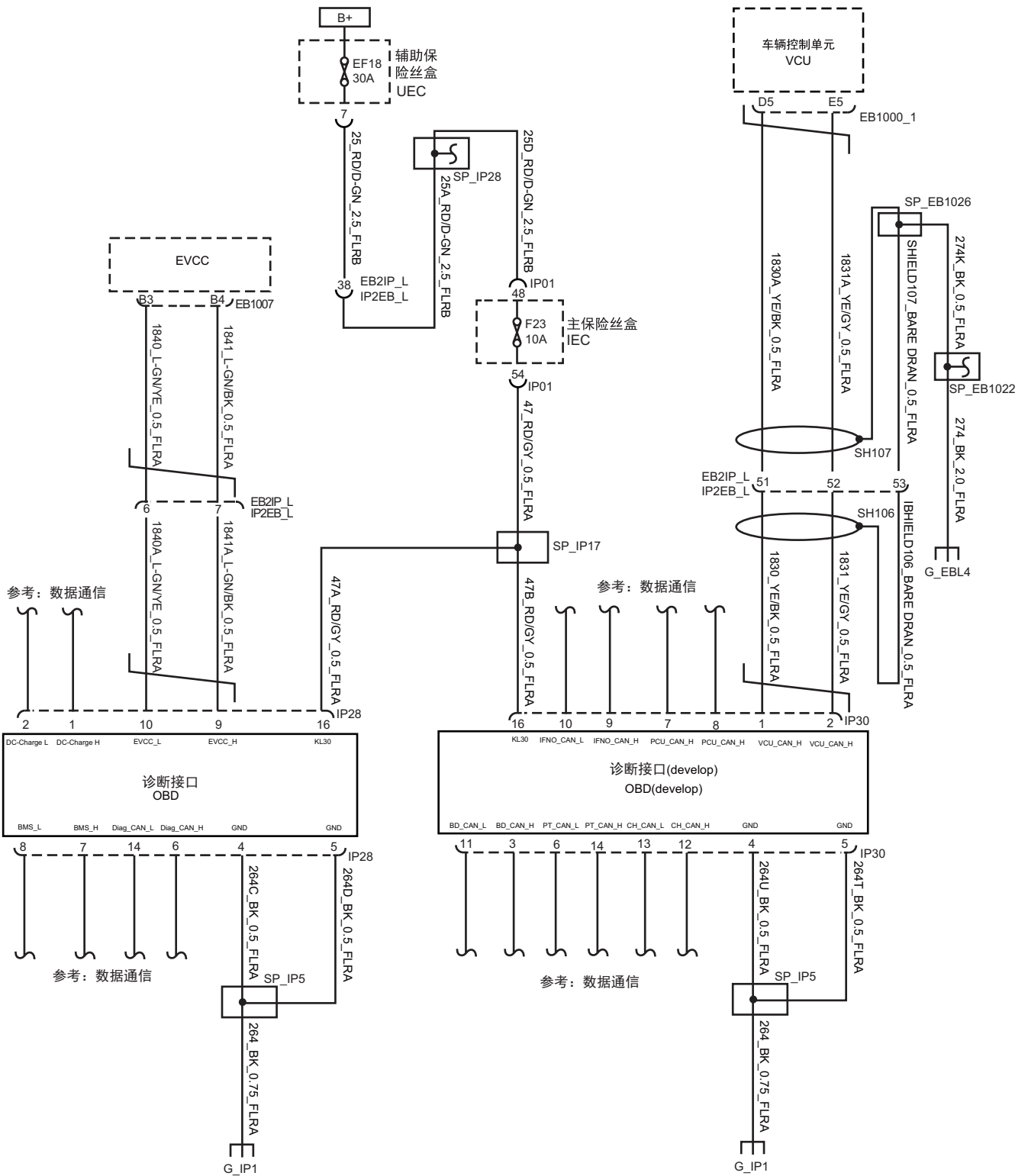

5.23 Electric Windows system

5.23.1 Electric Windows system - Left Rudder

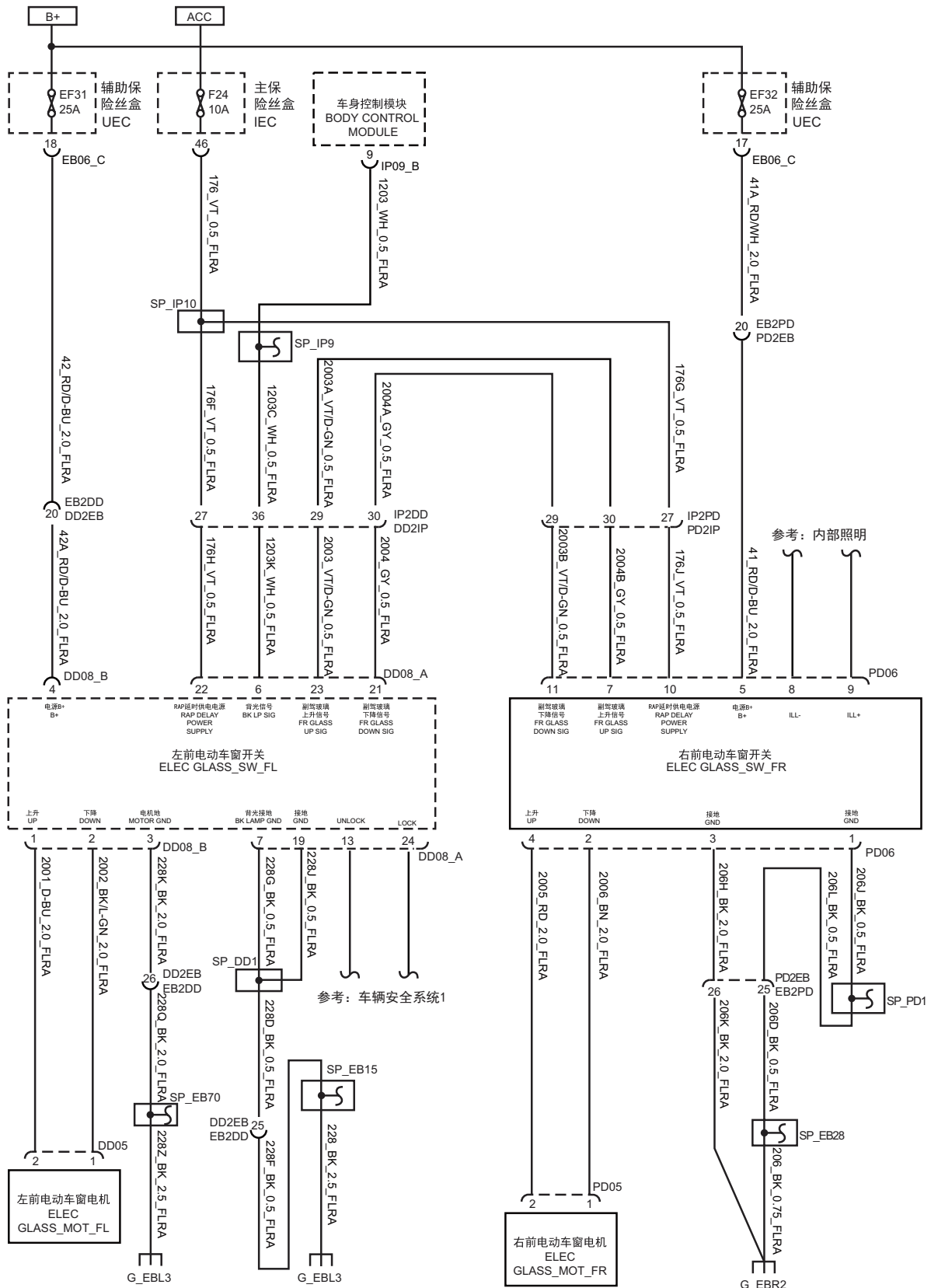

5.23.2 Electric Windows system - Right Rudder

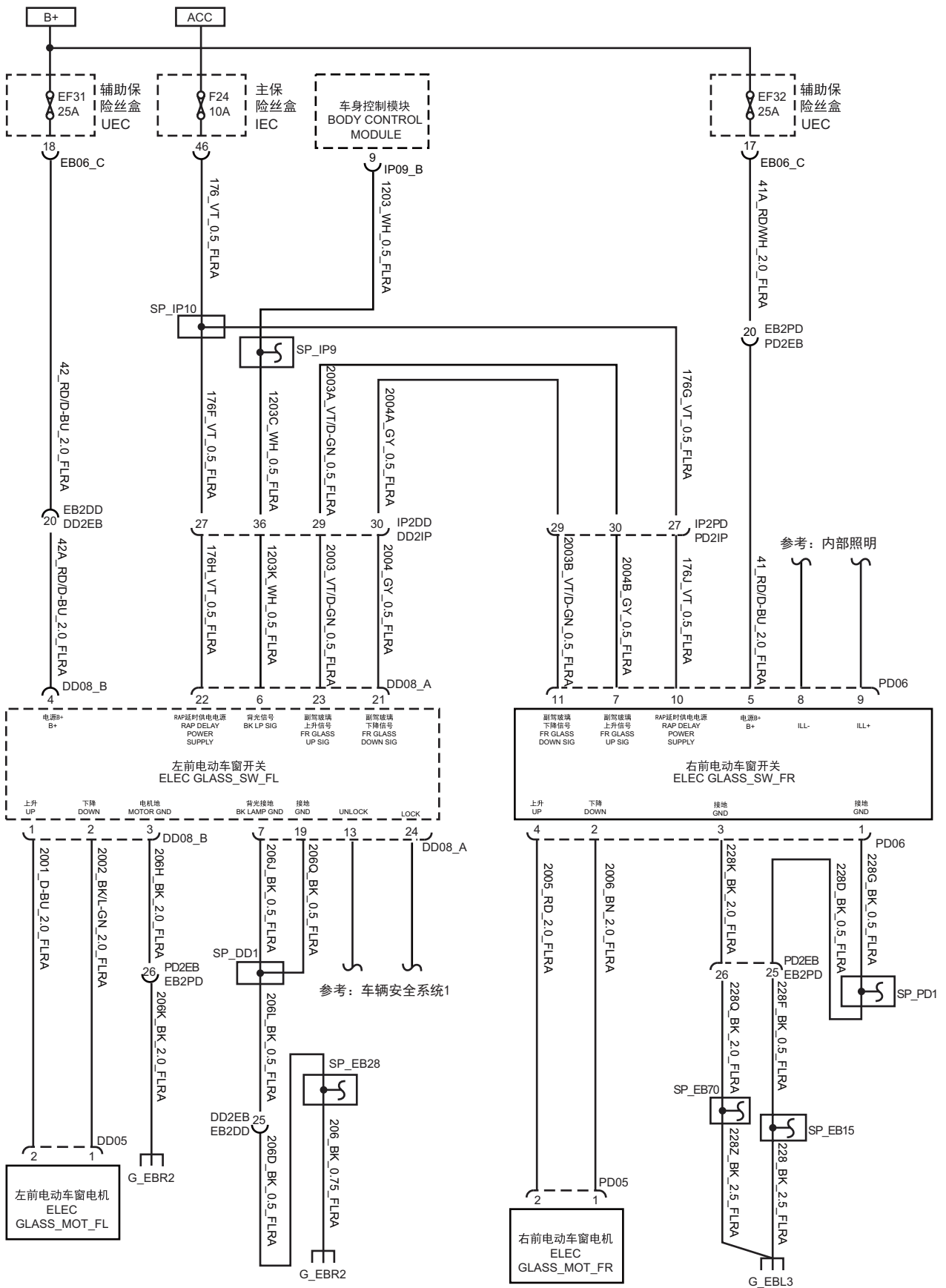

5.24 Power Pedal system

5.24.1 Power Pedal system - Left Rudder

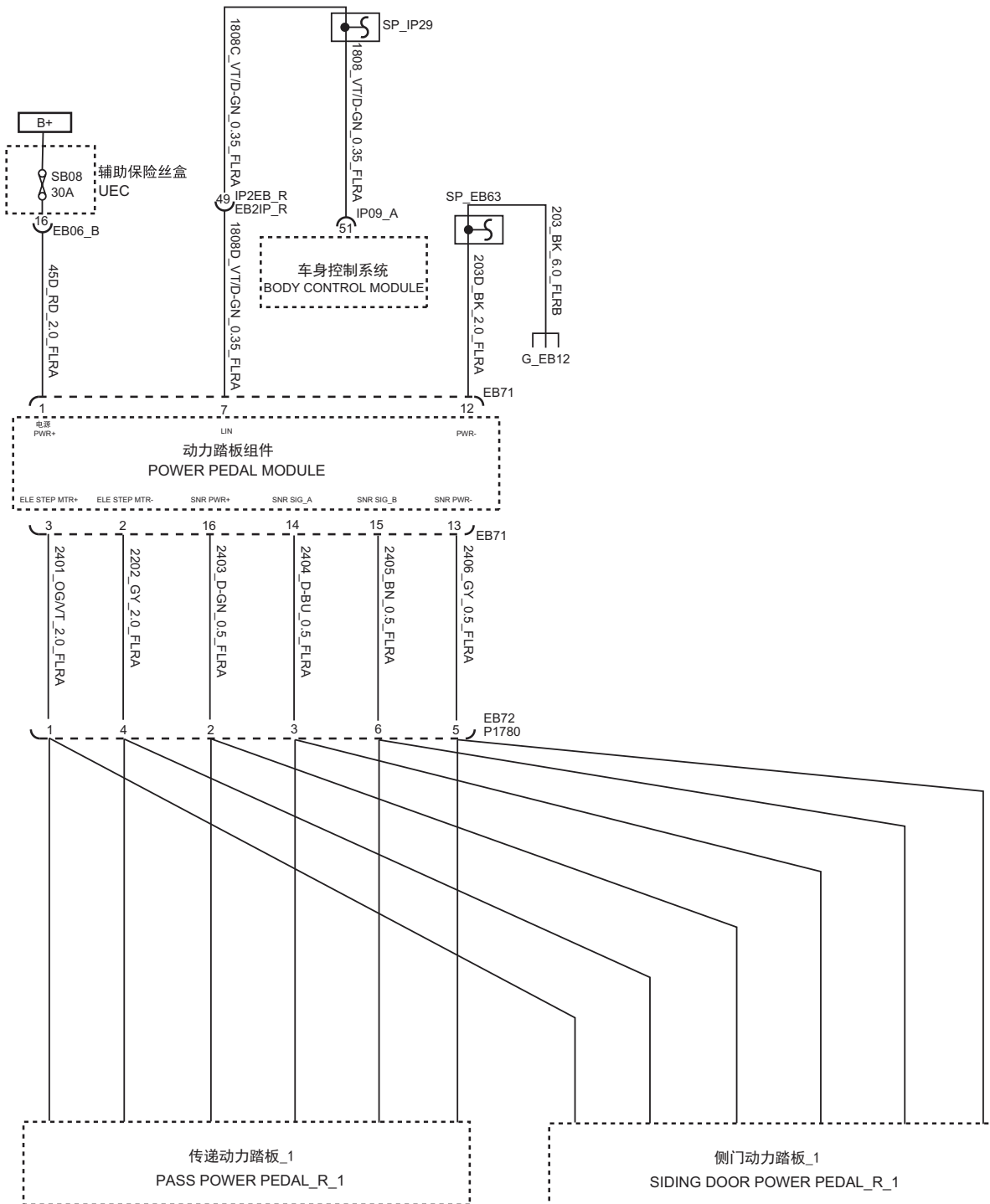

5.24.2 Power Pedal system - Right Rudder

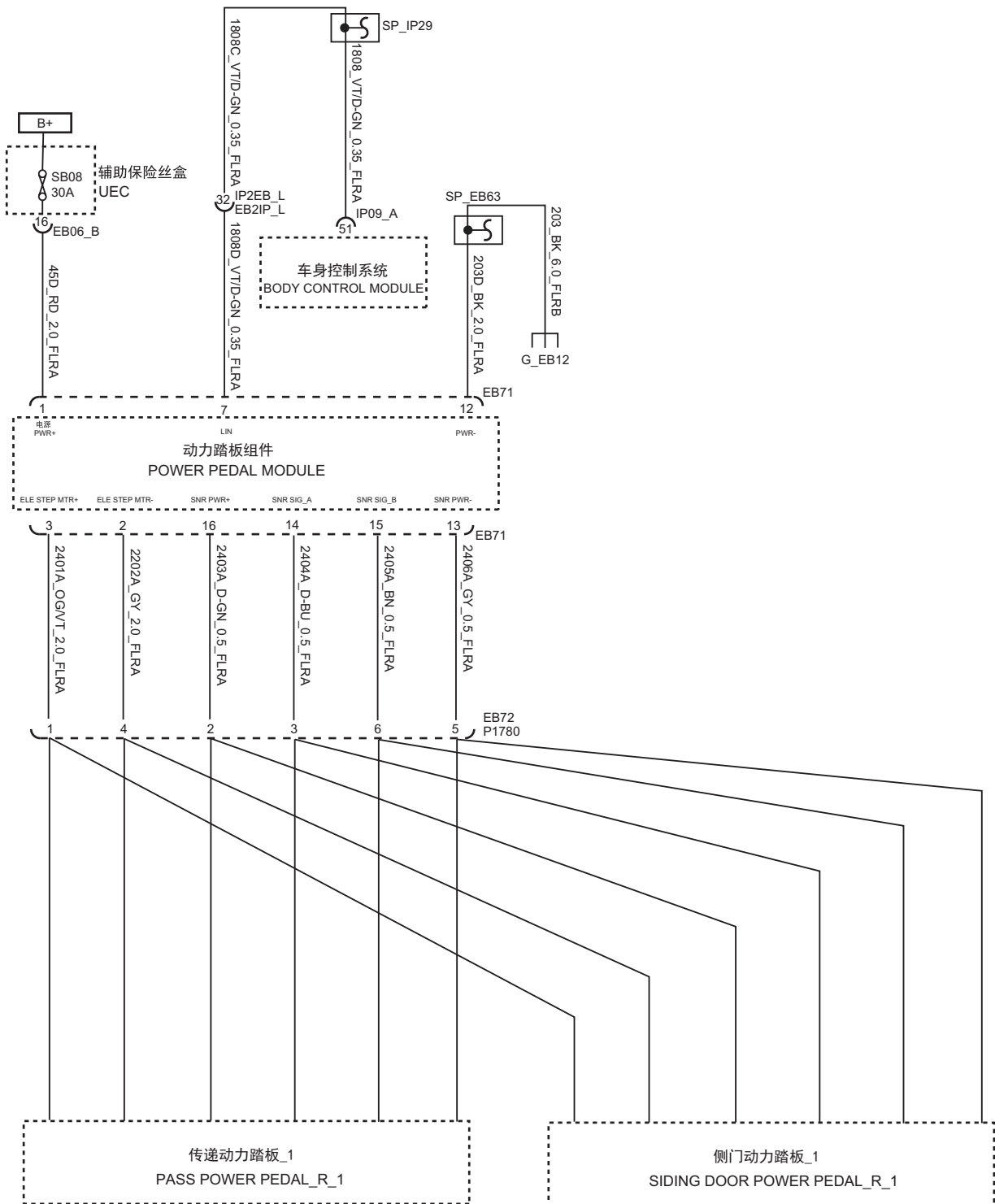

5.25 Horn and switch system

5.25.1 Horn and switch - Left Rudder

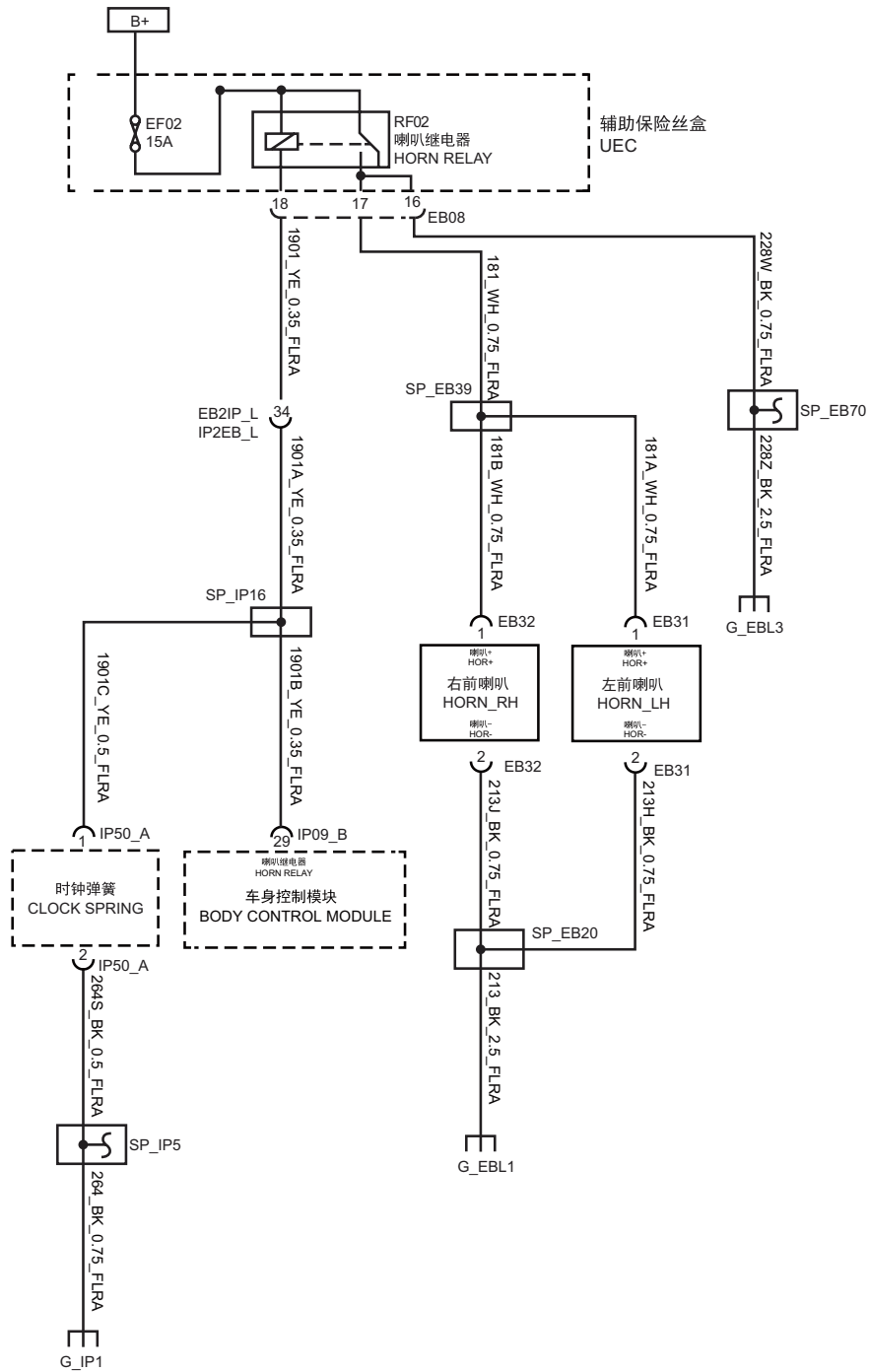

5.26 Passive Entry & Passive Start System

5.26.1 Passive Entry & Passive Start System 1 - Left Rudder

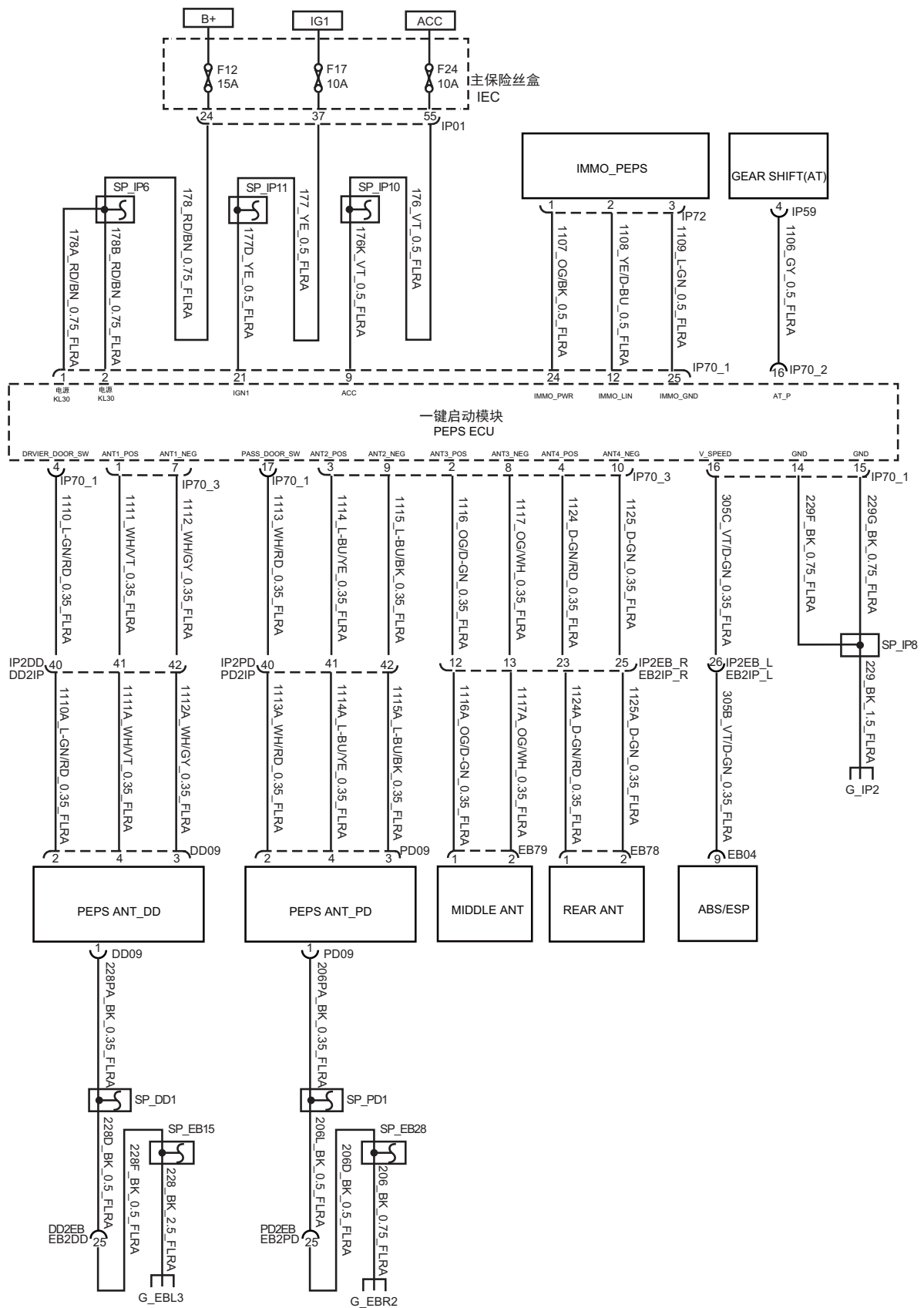

5.26.2 Passive Entry & Passive Start System 2 - Left Rudder

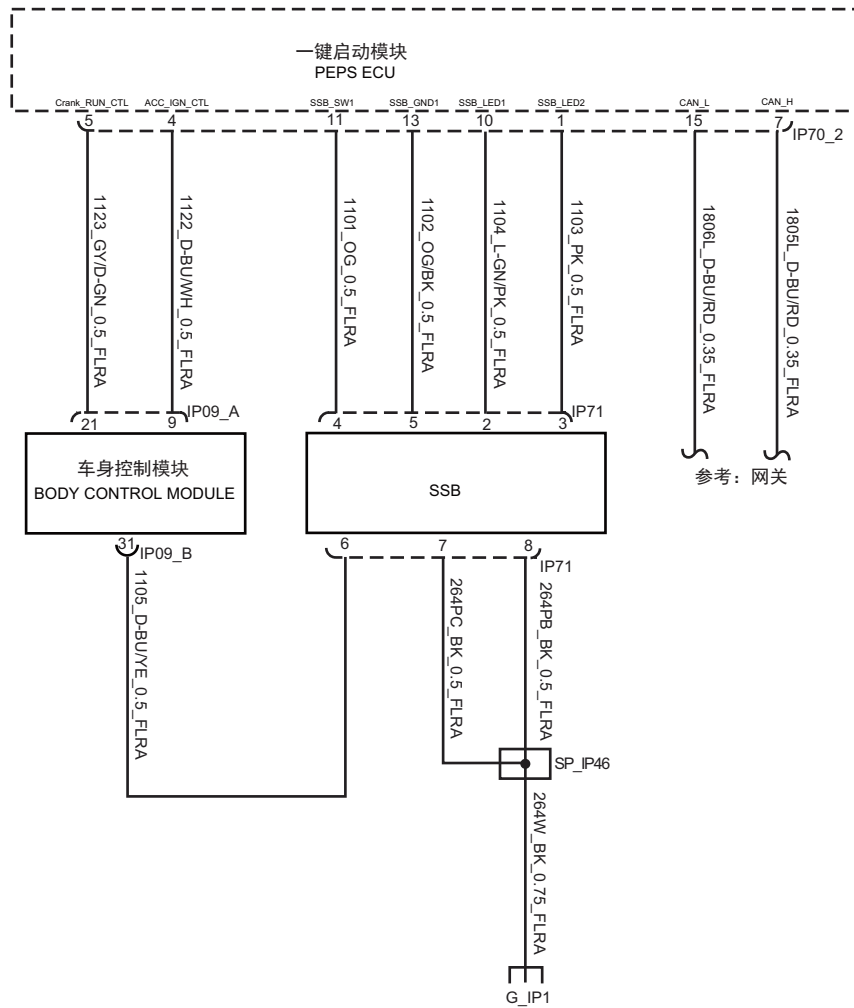

5.26.4 Passive Entry & Passive Start System 2 – Right Rudder

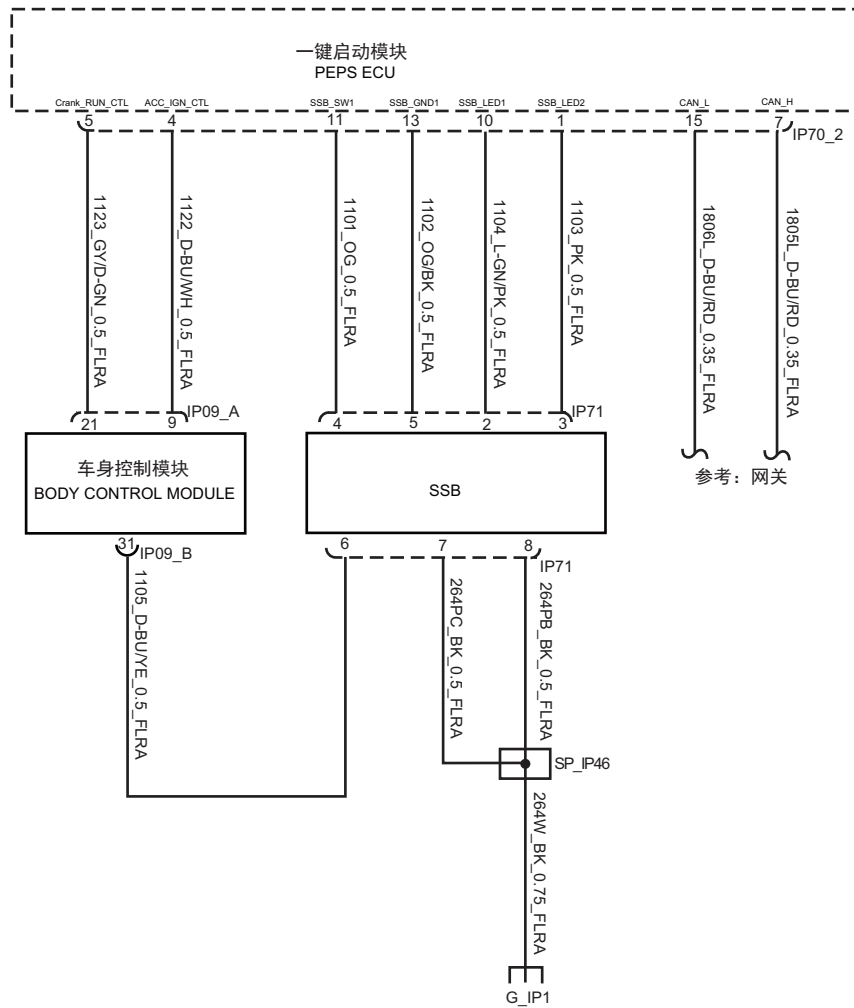

5.27 Fire extinguisher system

5.27.1 Fire extinguisher system

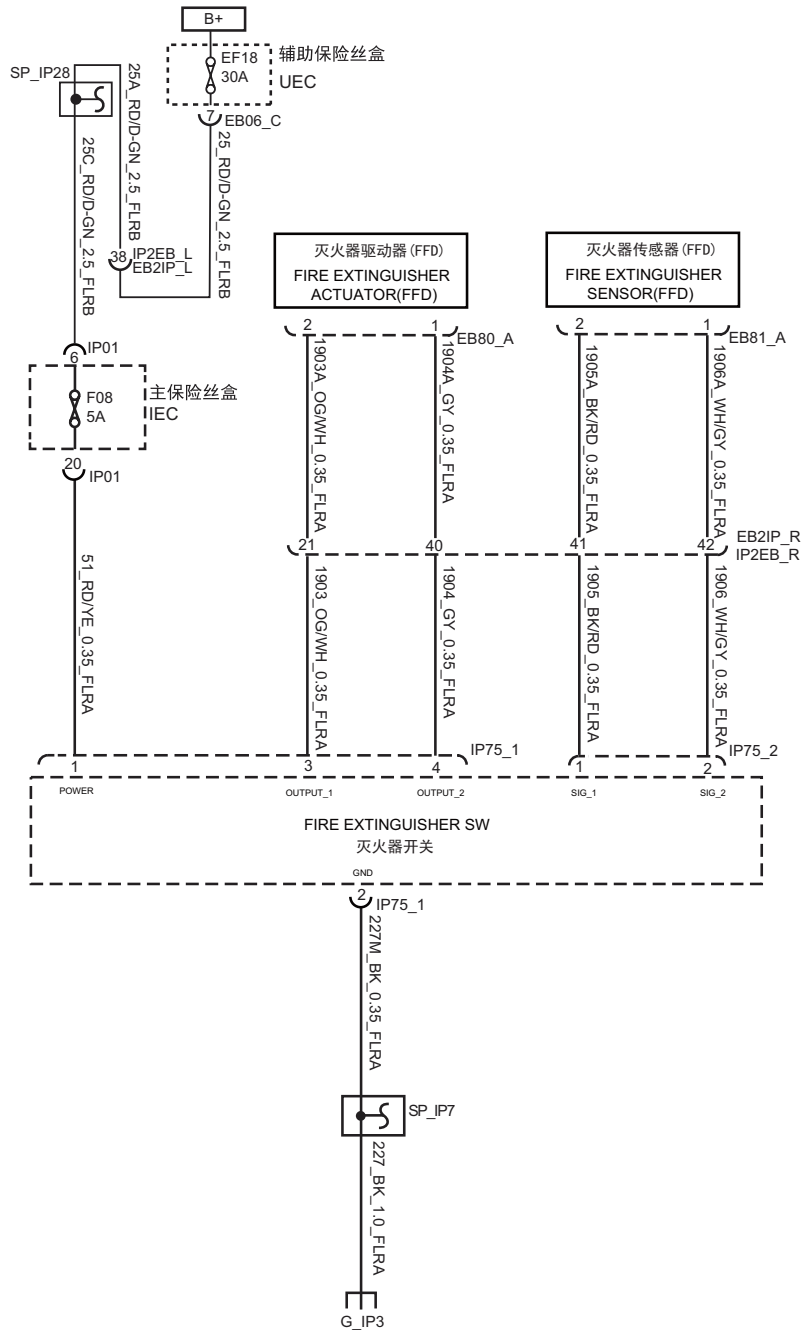

5.28 Cooling Fan System

5.28.1 Cooling Fan System 1 - Left Rudder

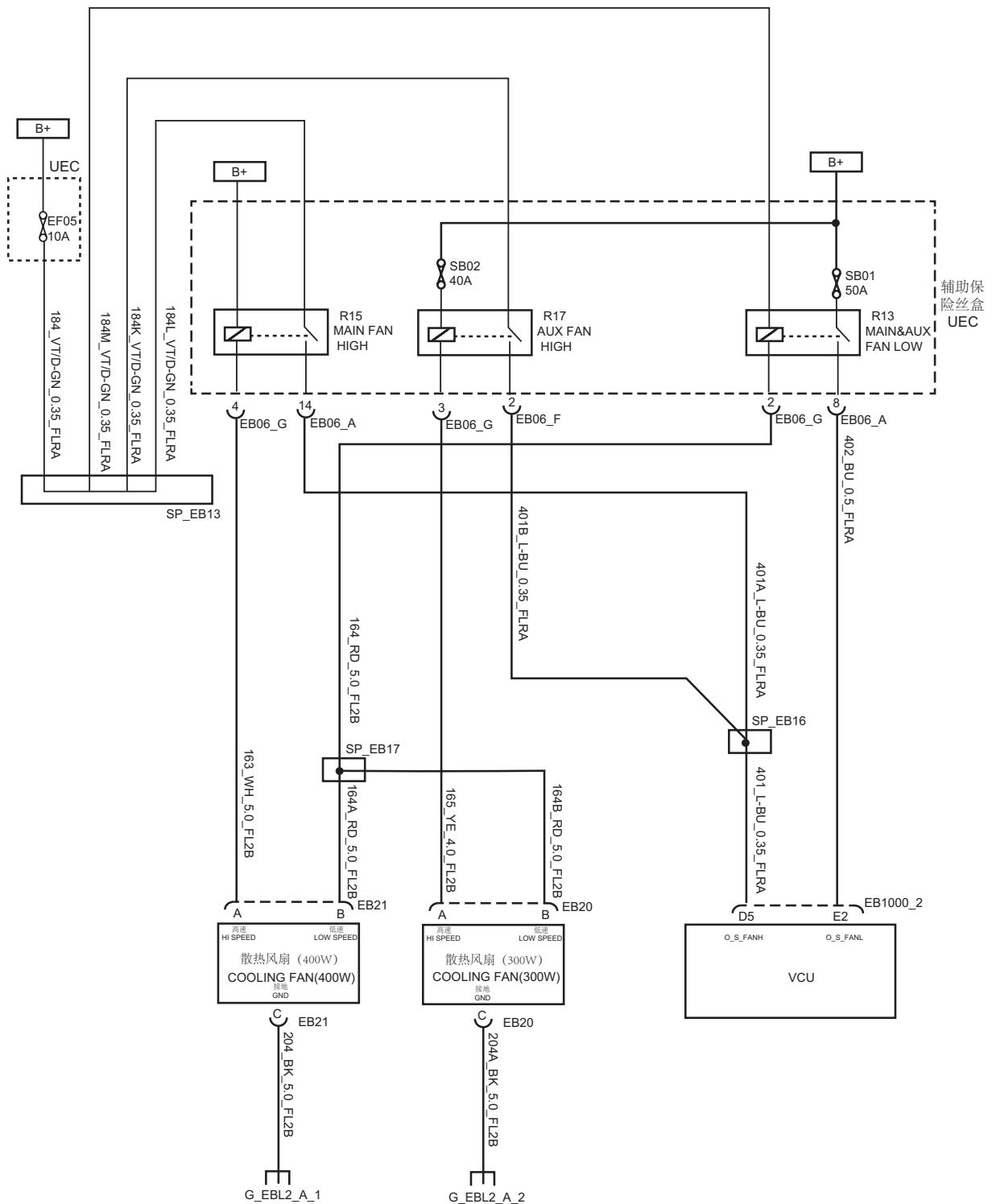

5.28.2 Cooling Fan System 2 - Left Rudder

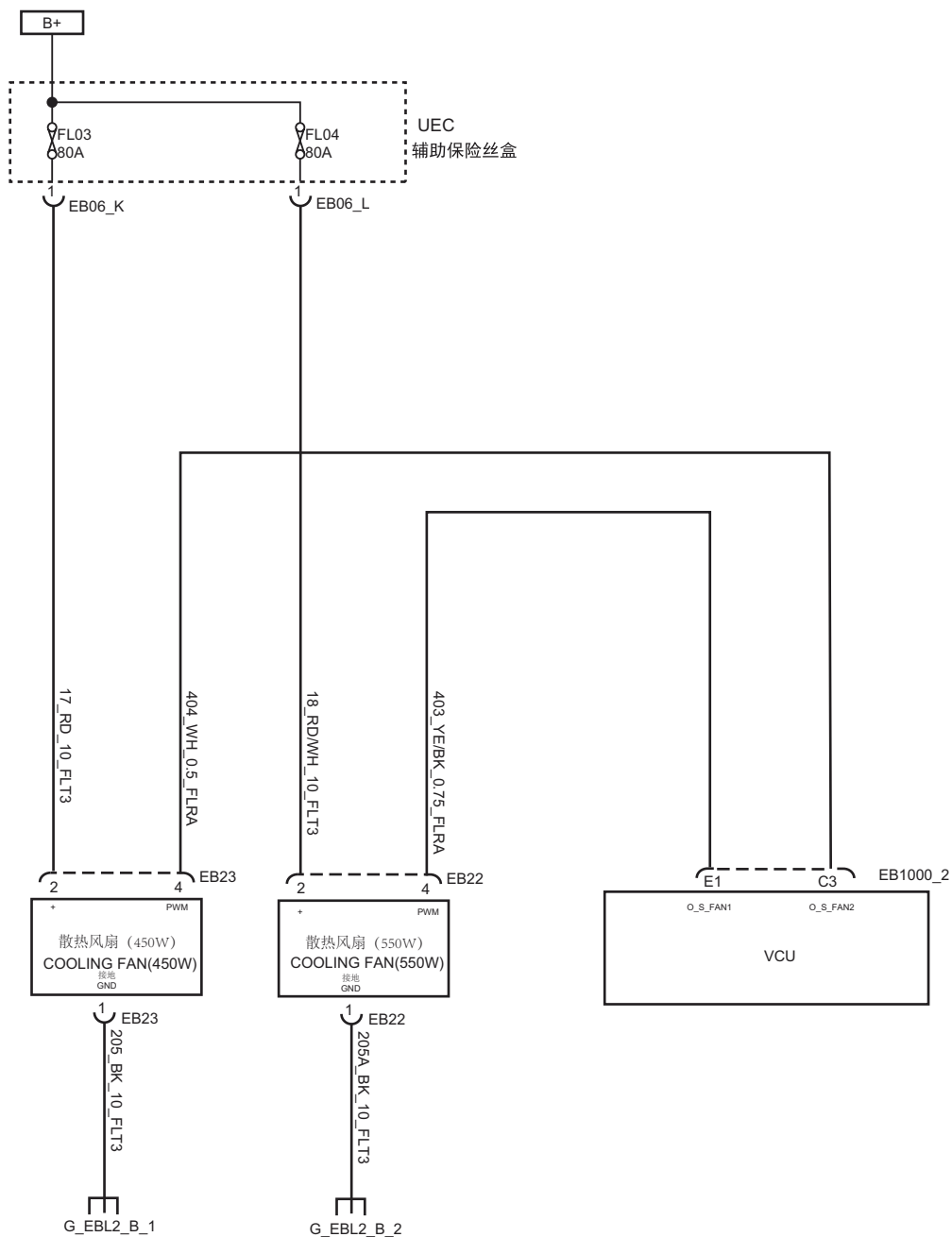

5.28.3 Cooling Fan System - Right Rudder

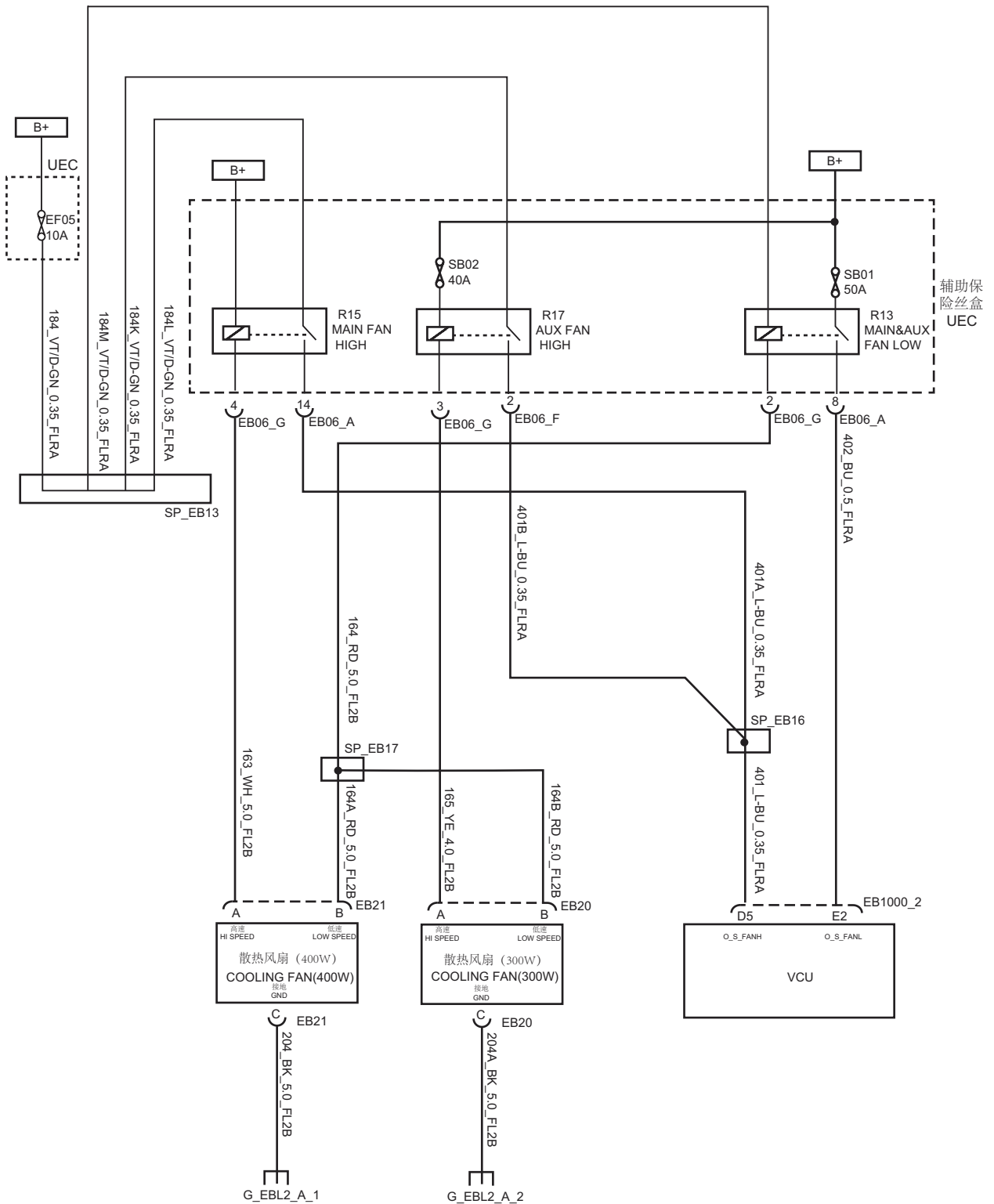

5.29 Parking Distance Control System

5.29.1 Parking Distance Control System 1 - Left Rudder

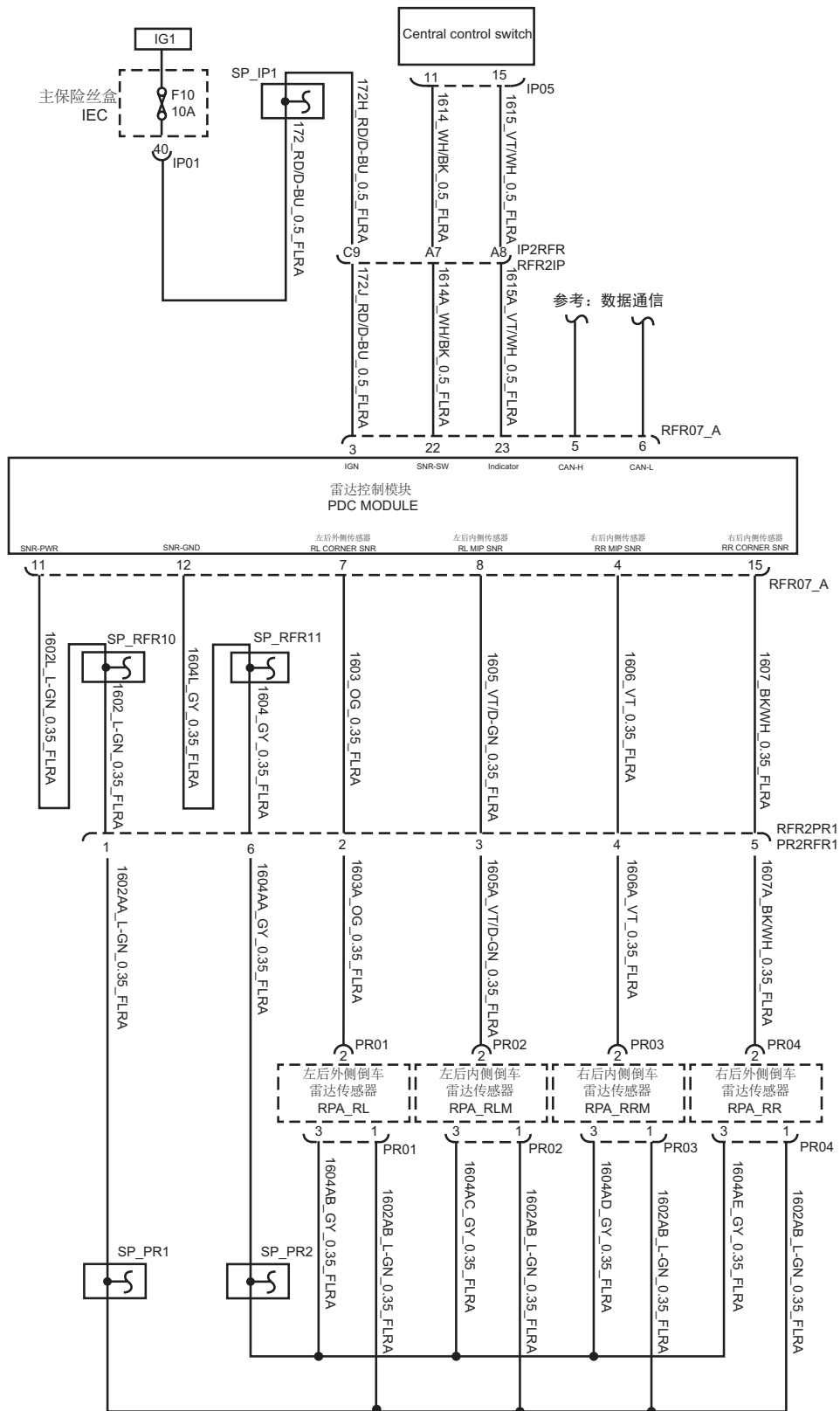

5.29.2 Parking Distance Control System 2 - Left Rudder

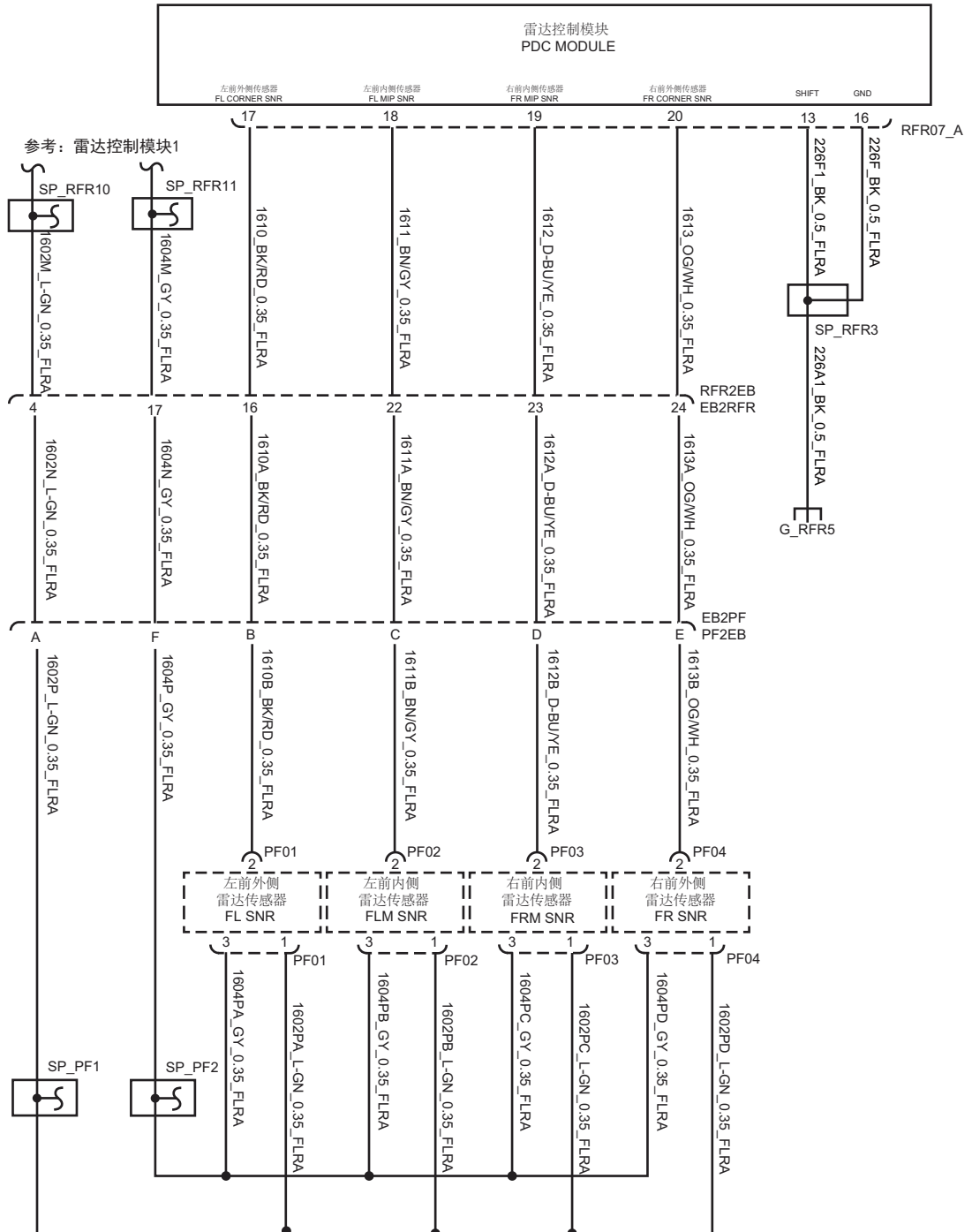

5.29.3 Parking Distance Control System 1 - Right Rudder

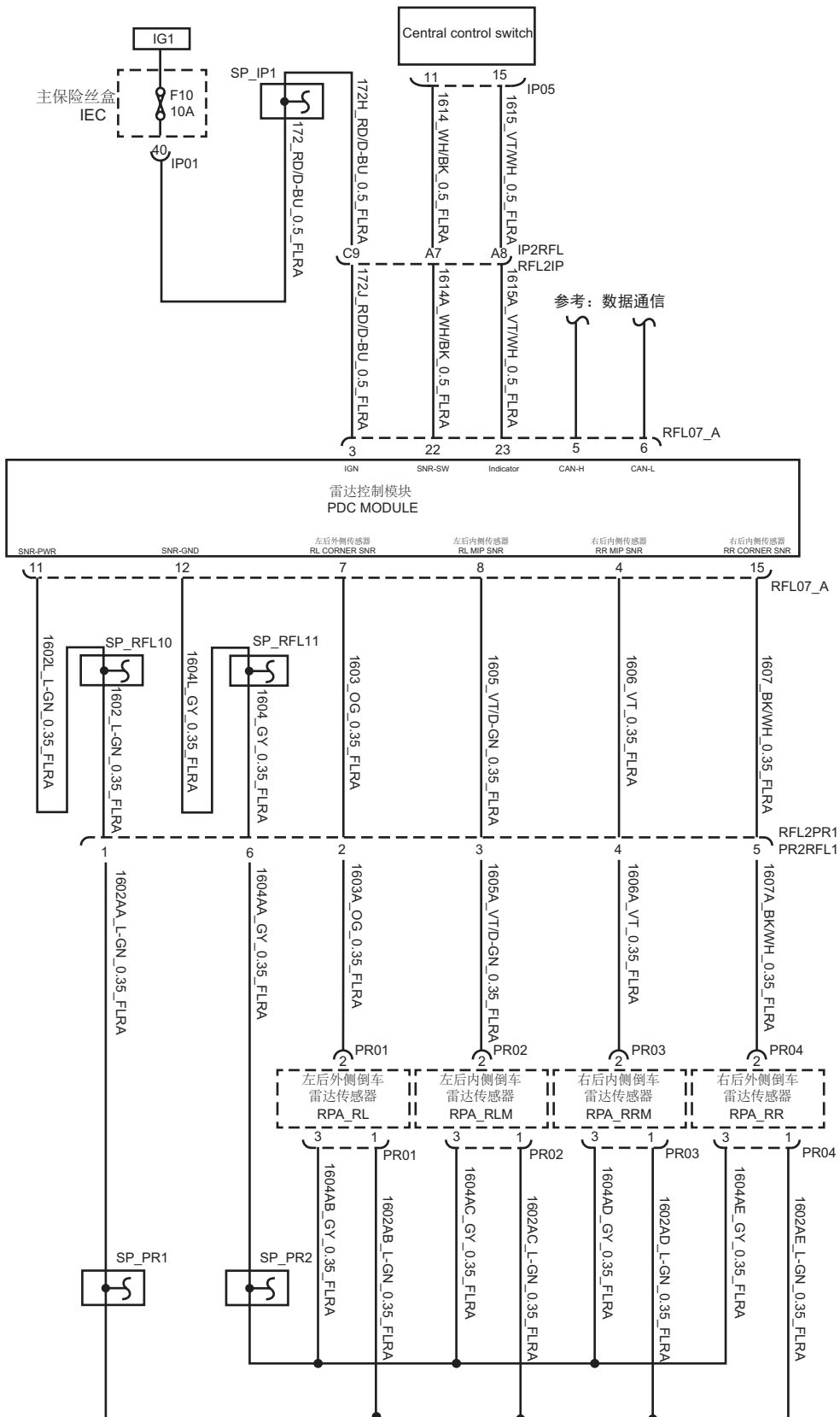

5.29.4 Parking Distance Control System 2 – Right Rudder

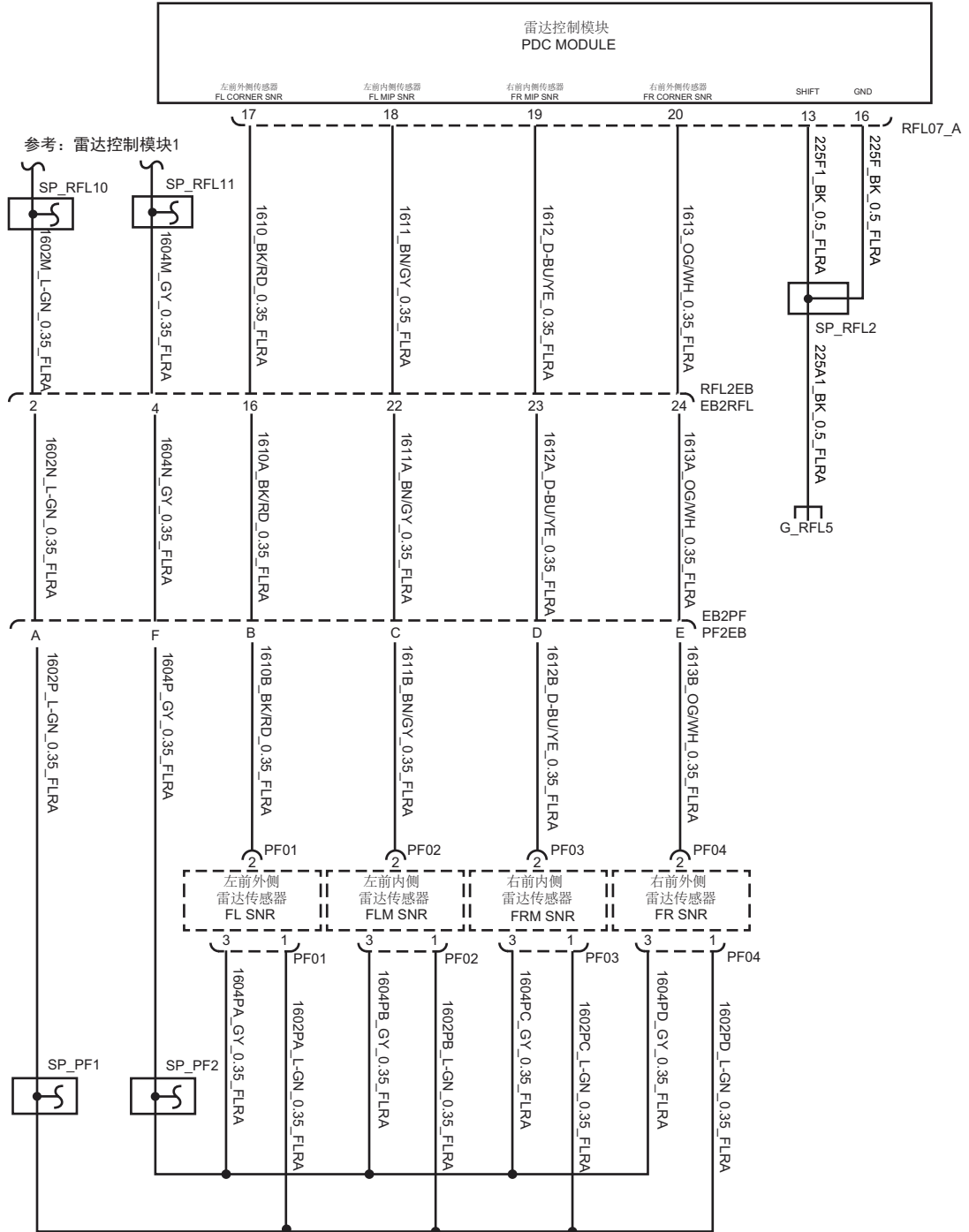

5.30 Electronic shift system

5.30.1 Electronic shift system - Left Rudder

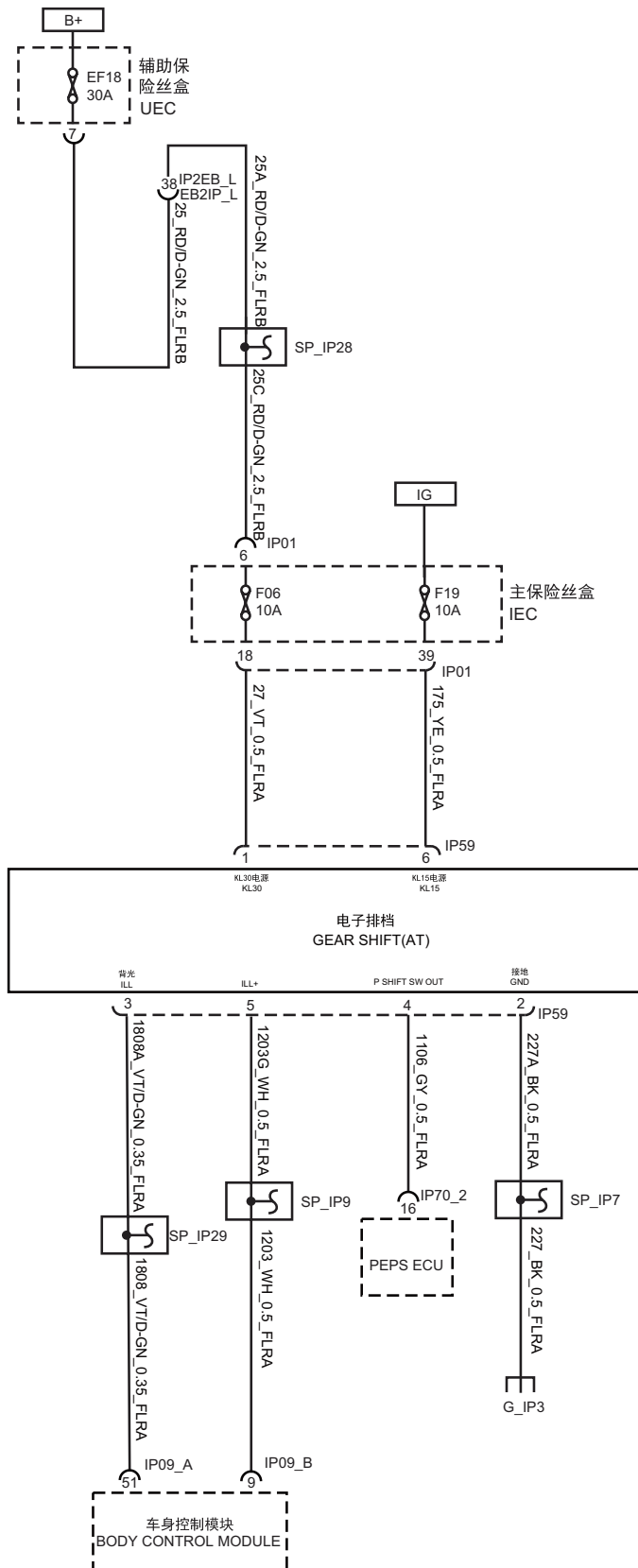

5. 30. 2 Electronic shift system-Right Rudder

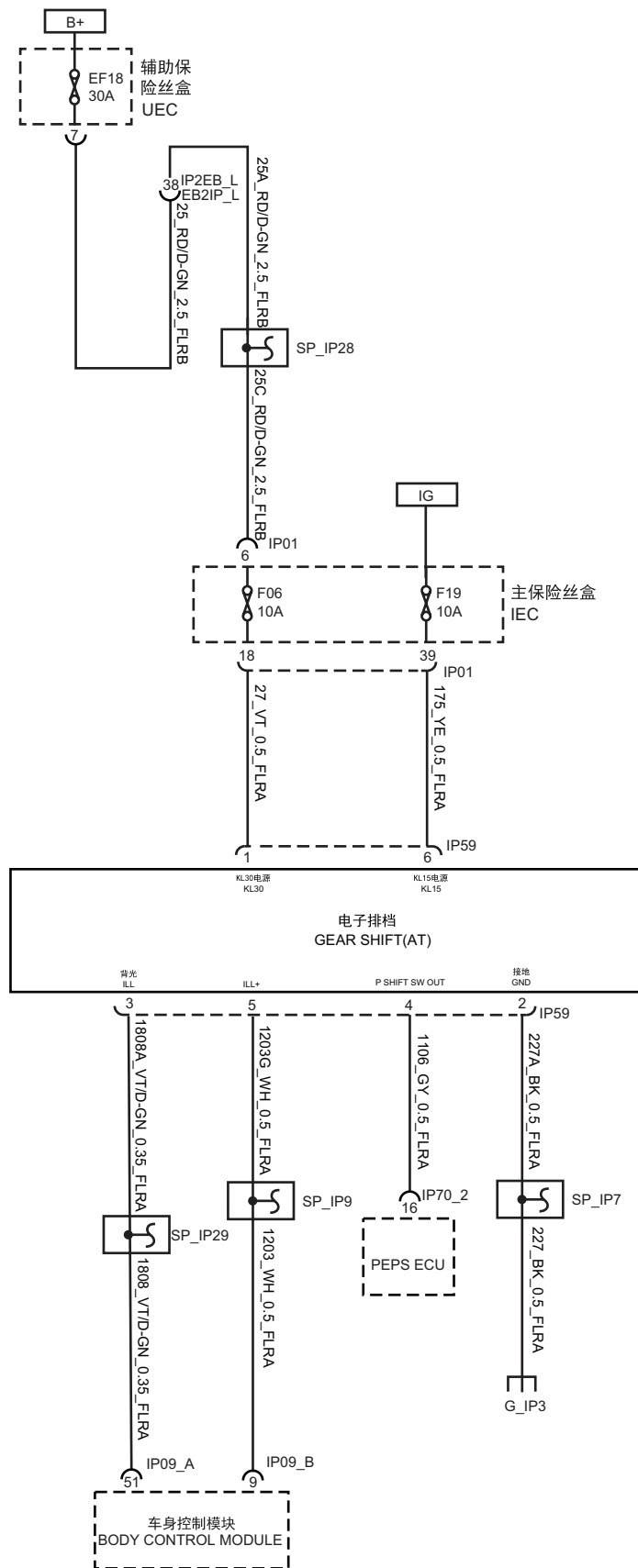

5.31 Wiper and scrubber

5.31.1 Wiper and scrubber - Left Rudder

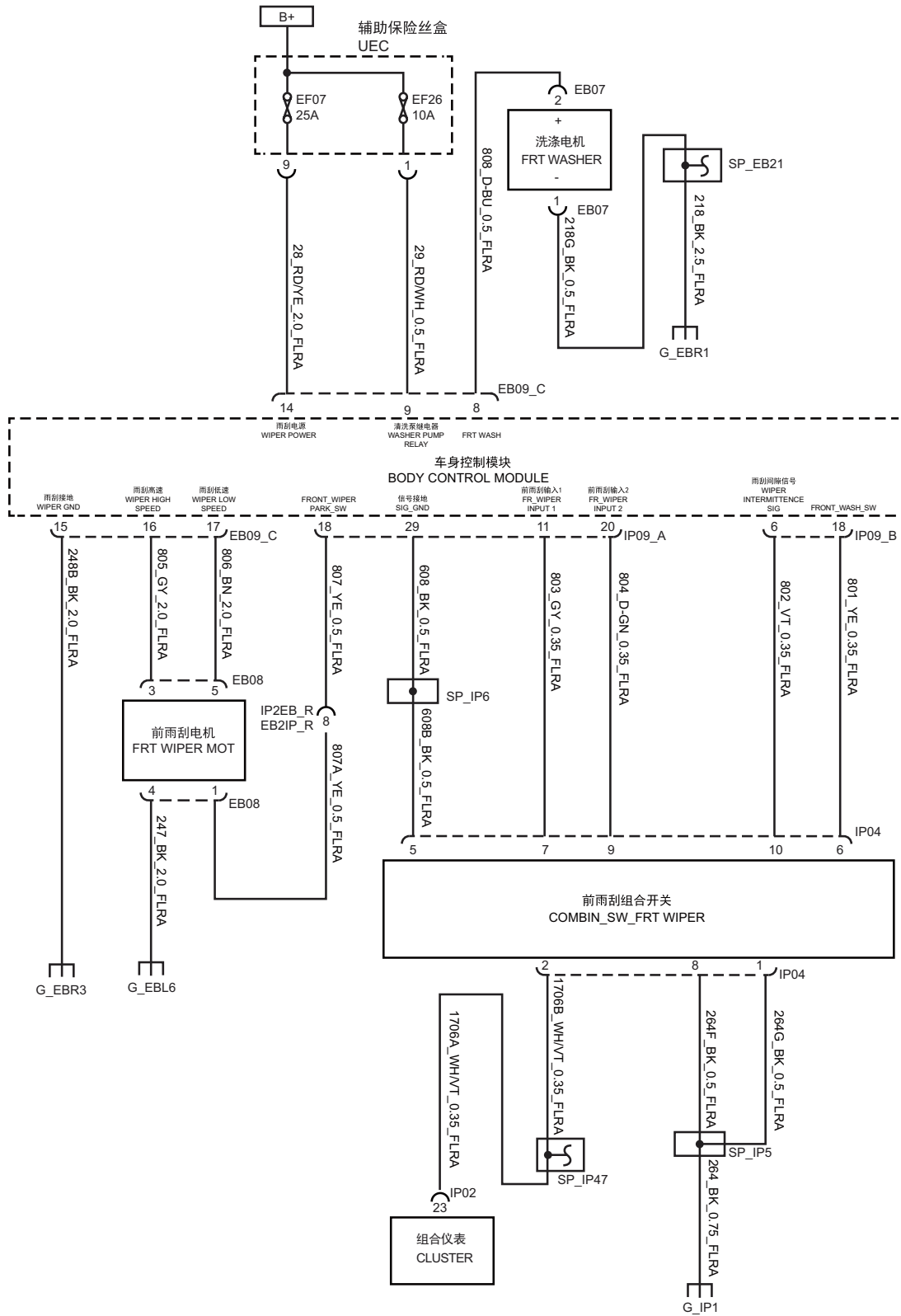

5. 31. 2 Wiper and scrubber - Right Rudder

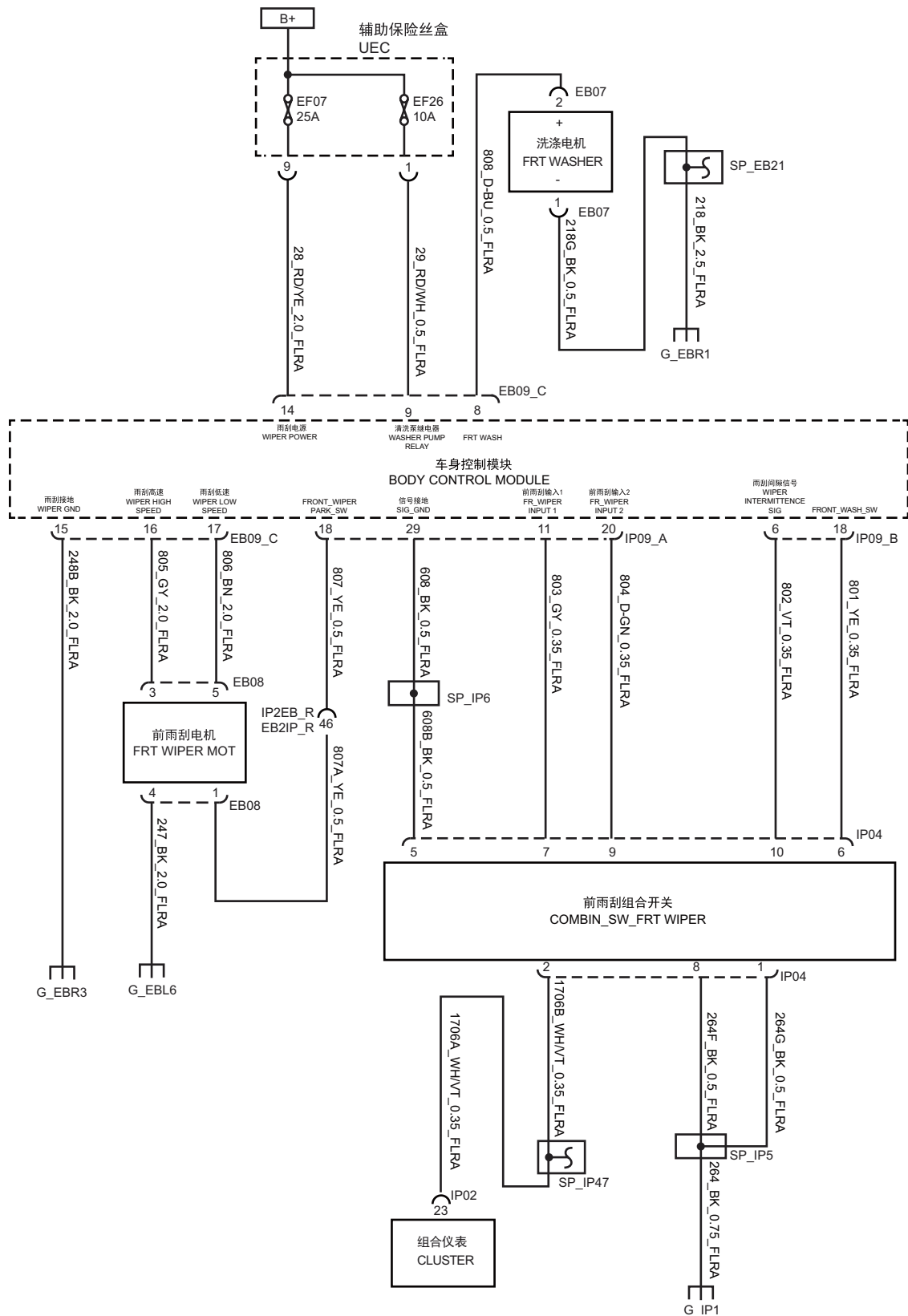

5.32 Driving Video Recorder System

5.32.1 Driving Video Recorder System - Left Rudder

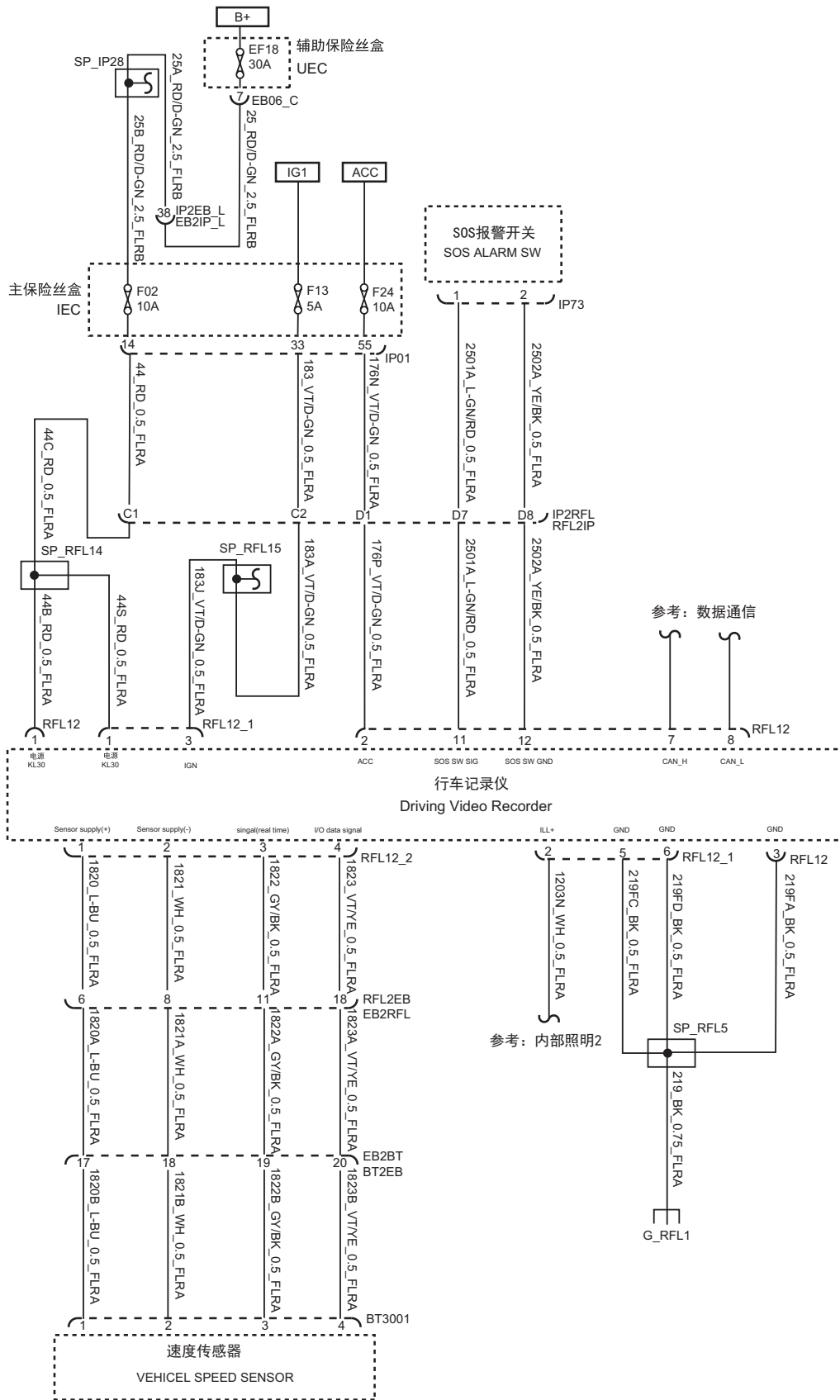

5.32.2 Driving Video Recorder System – Right Rudder

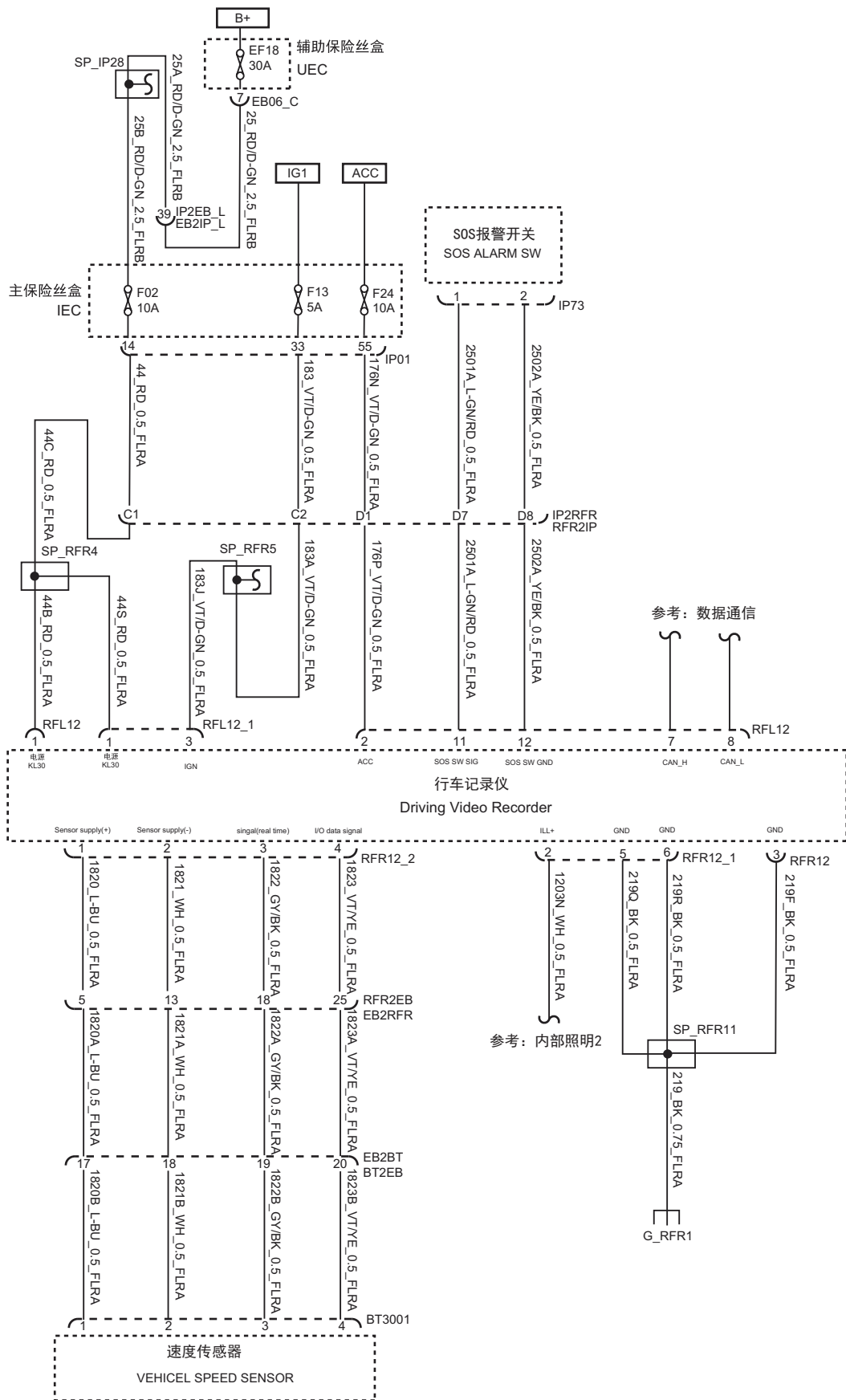

5.33 Battery Management System

5.33.1 Battery Management System (CN)1 - Left Rudder

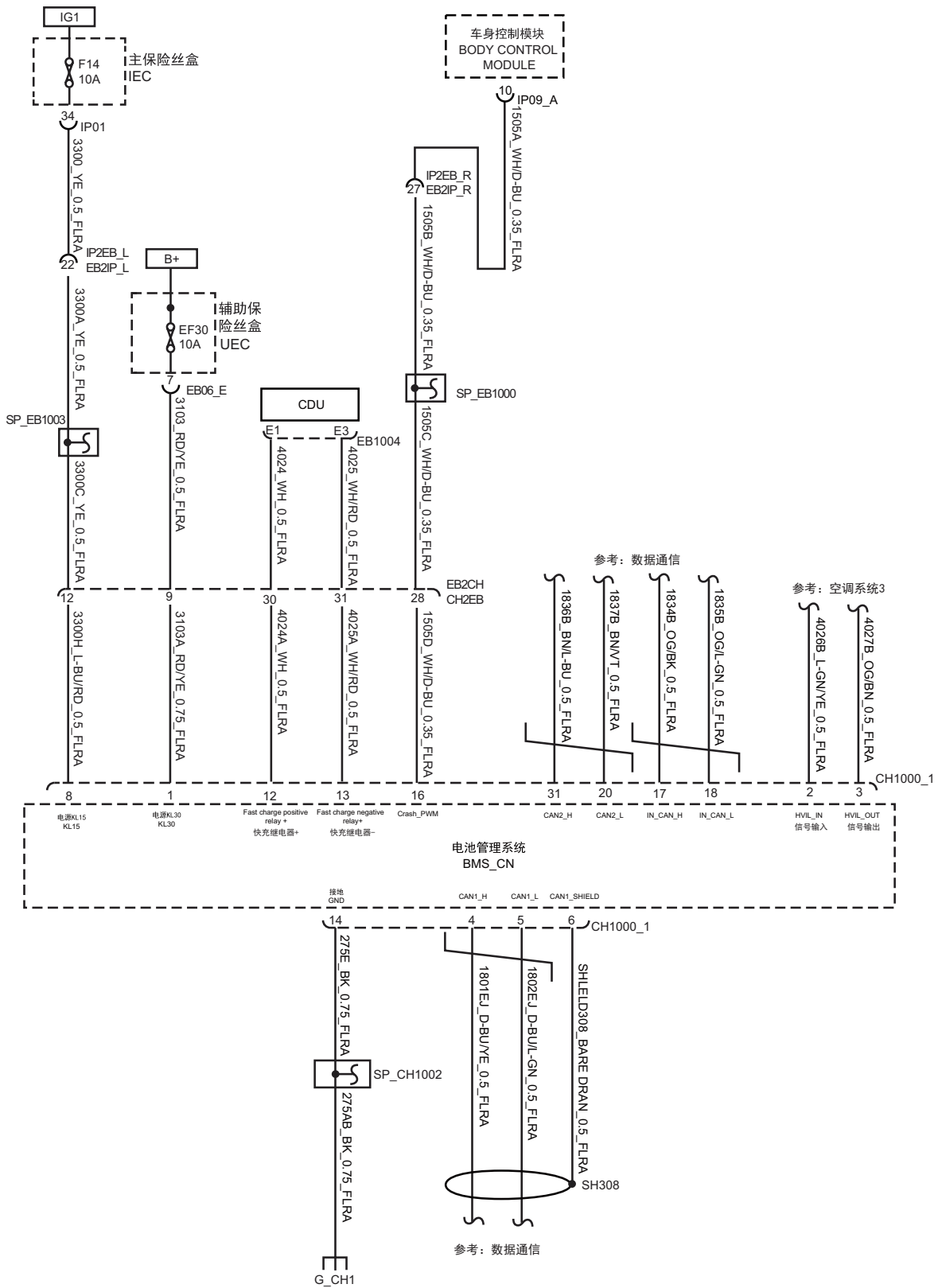

5.33.2 Battery Management System (CN)2 - Left Rudder

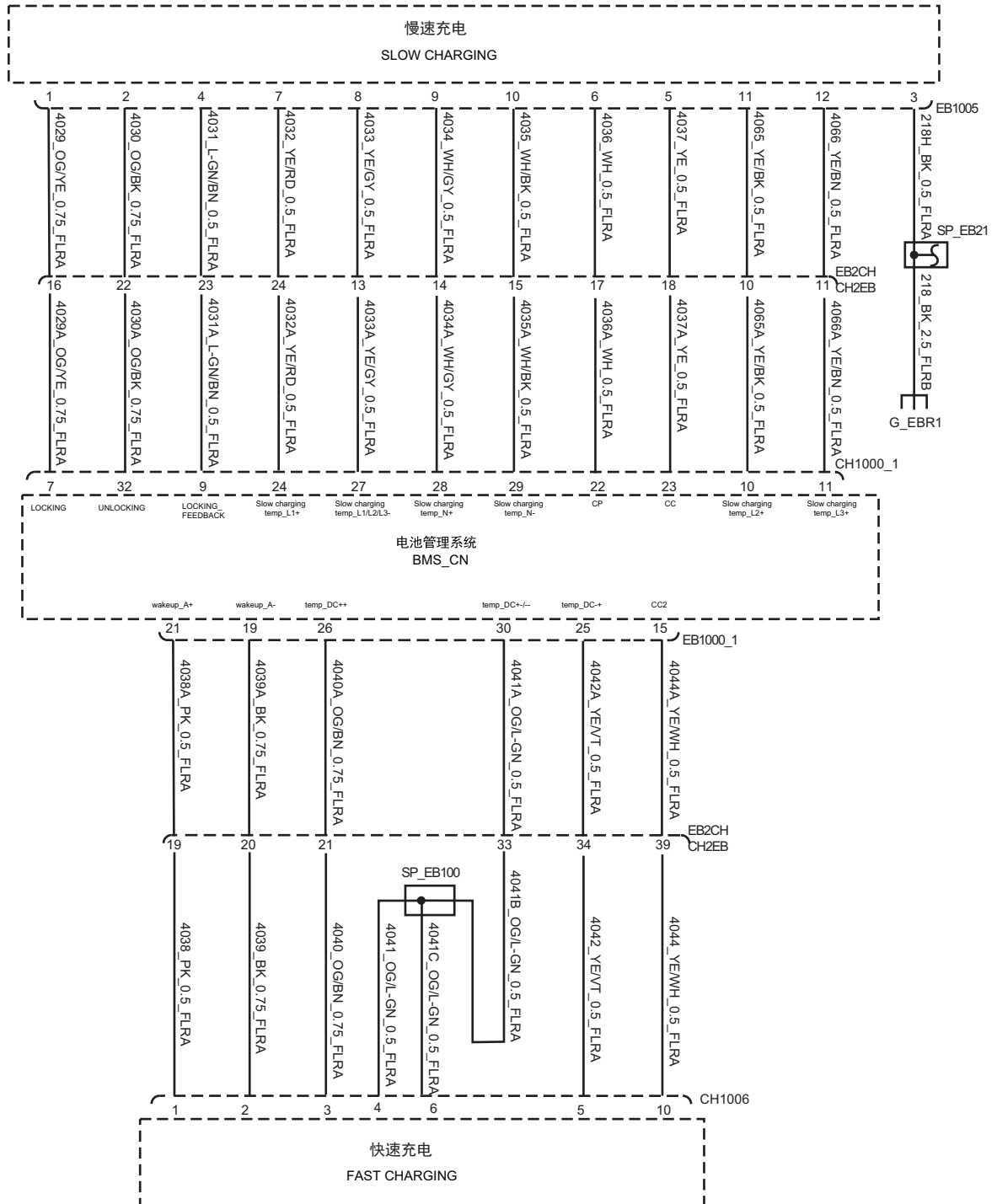

5.33.3 Battery Management System (FRA)1 - Left Rudder

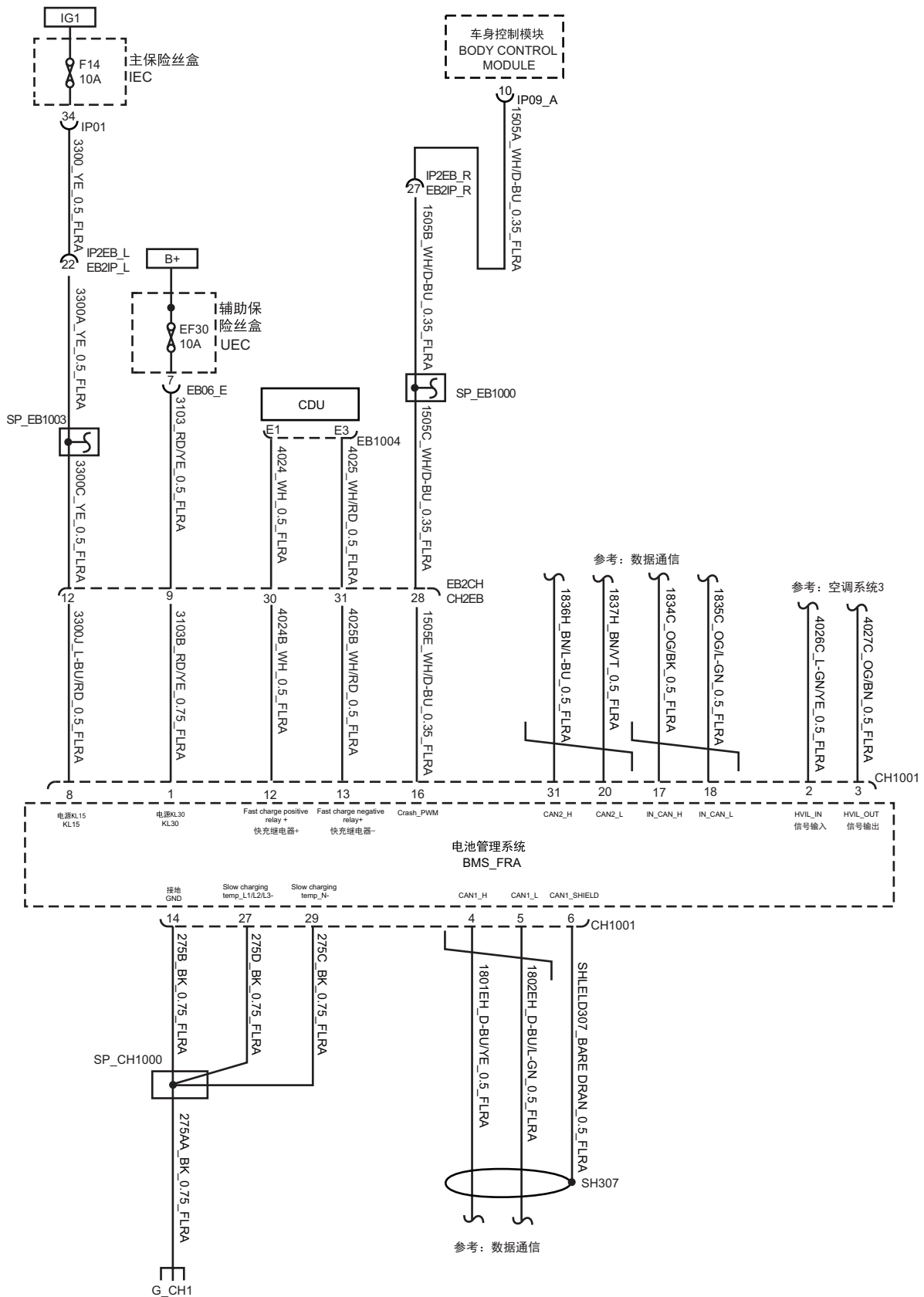

5.33.4 Battery Management System (FRA)2 - Left Rudder

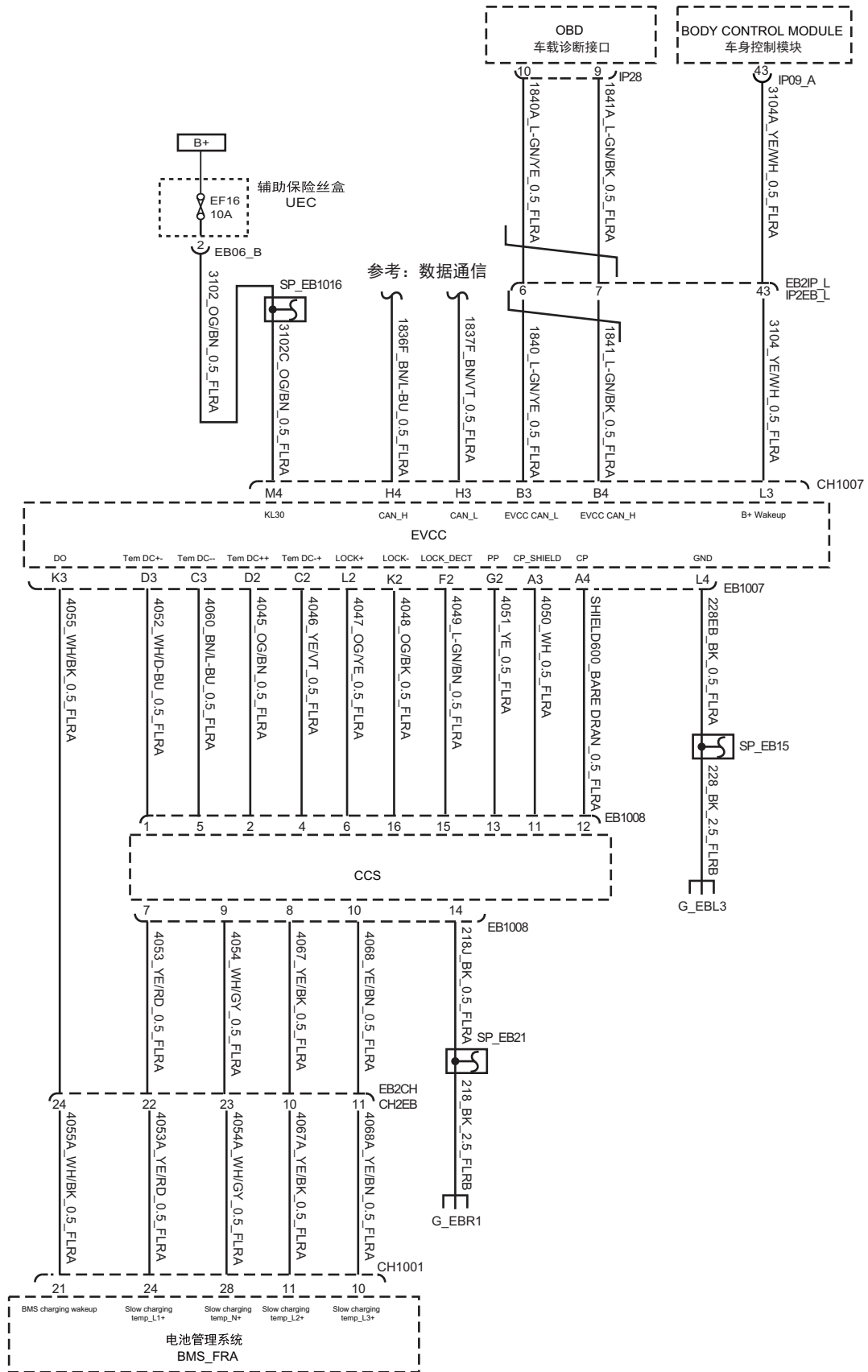

5.33.5 Battery Management System (FRA)1 – Right Rudder

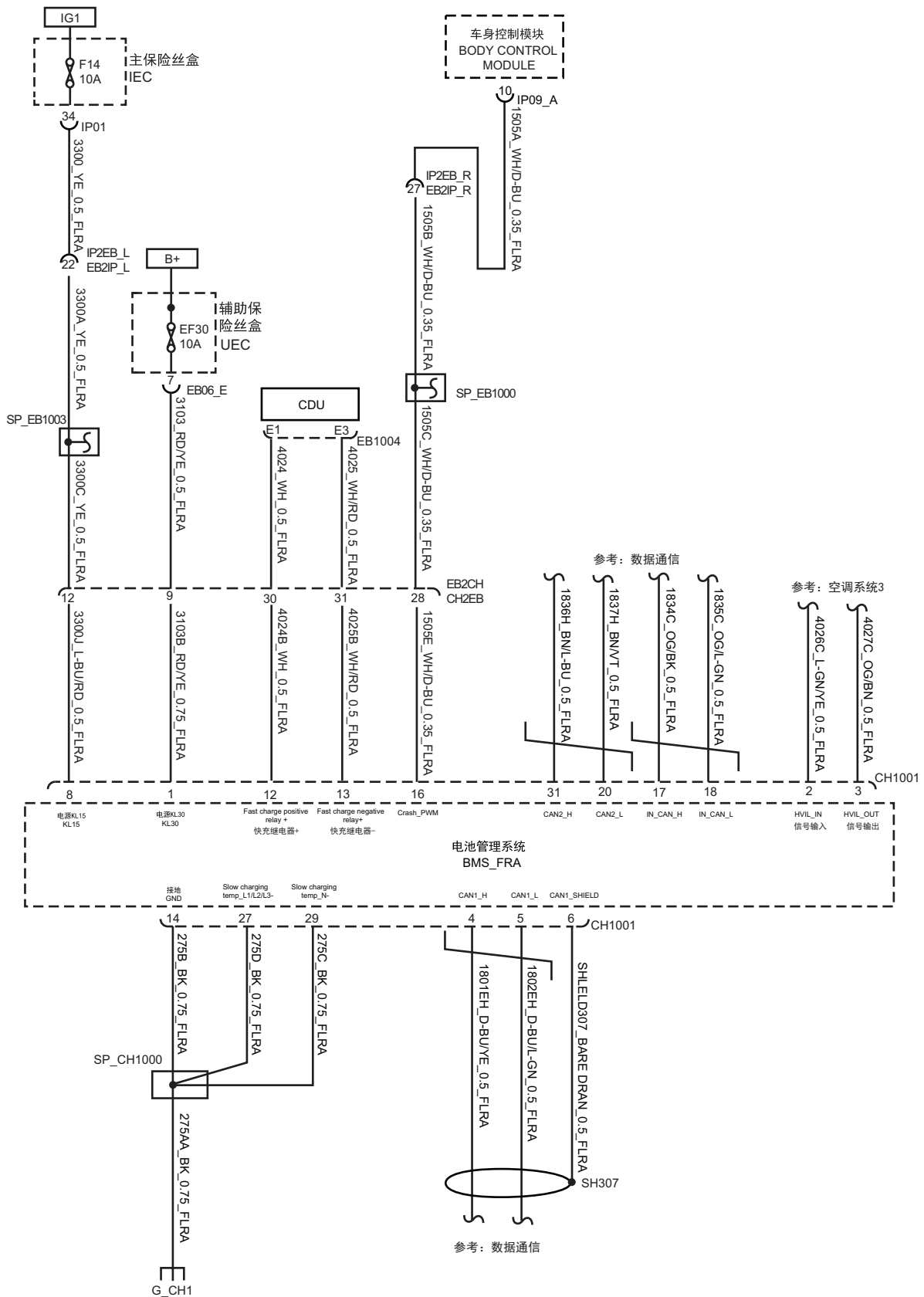

5.33.6 Battery Management System (FRA)2 - Right Rudder

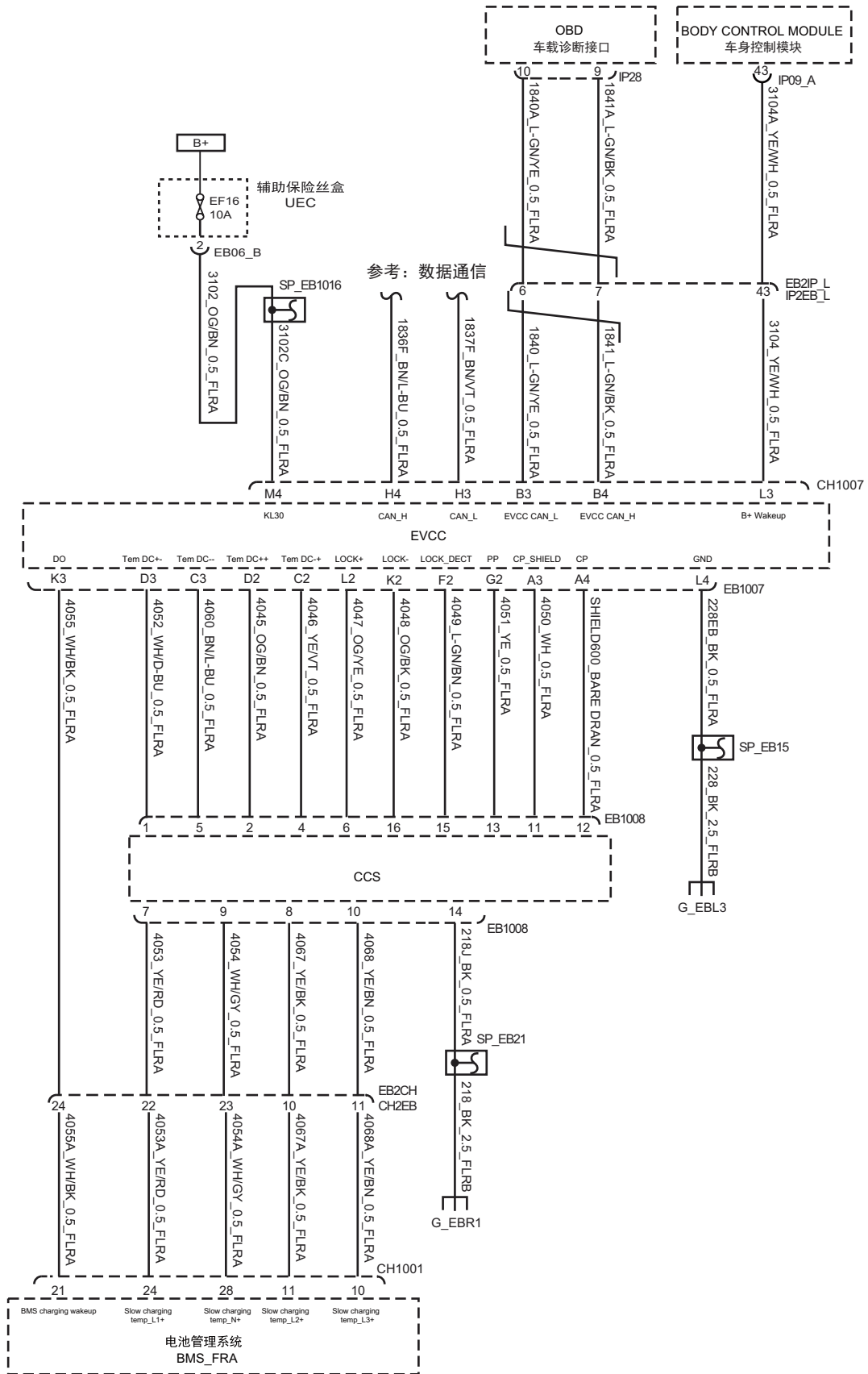

5.34 Gateway system

5.34.1 Gateway system 1 - Left Rudder

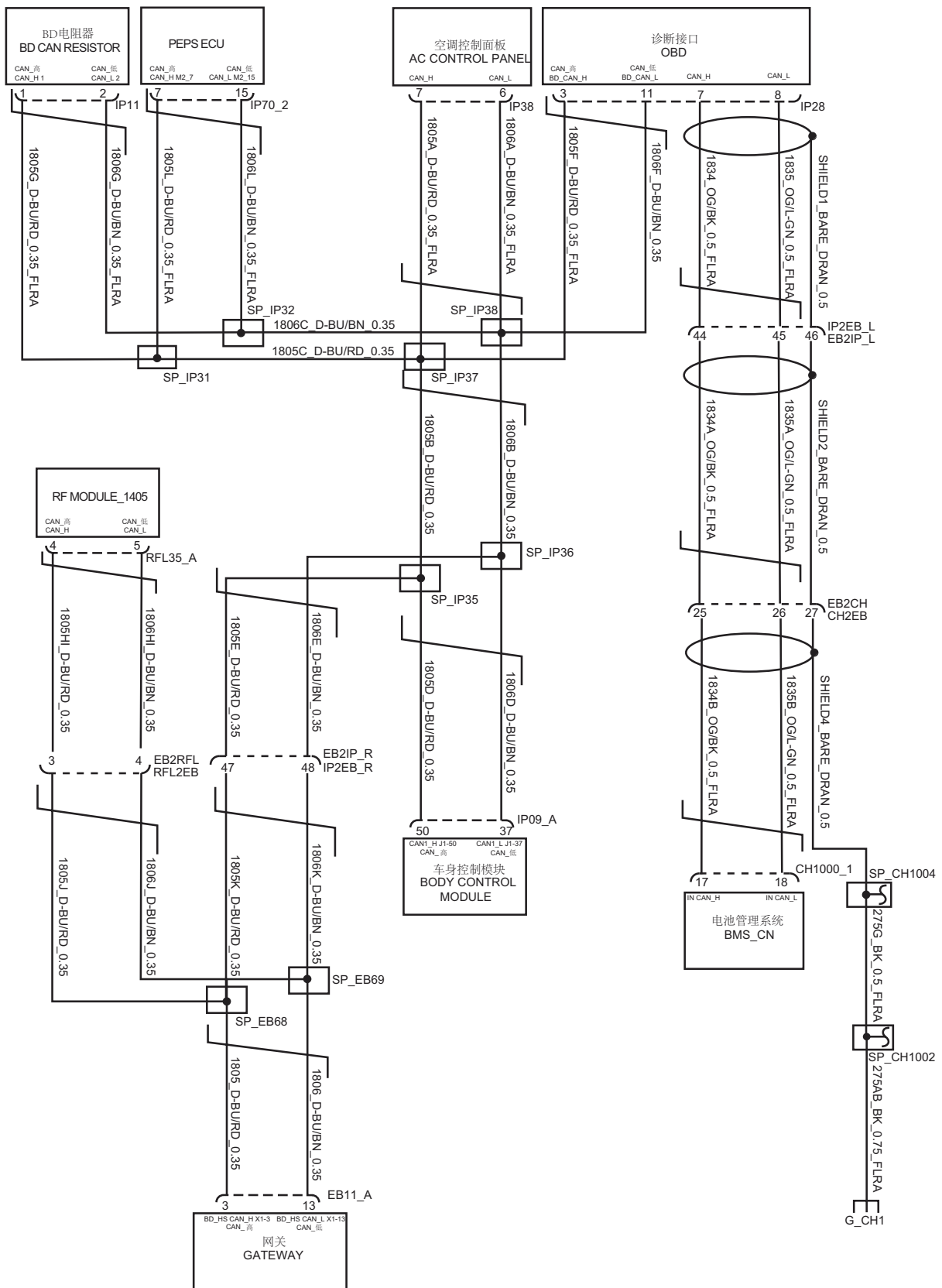

5.34.2 Gateway system 2 - Left Rudder

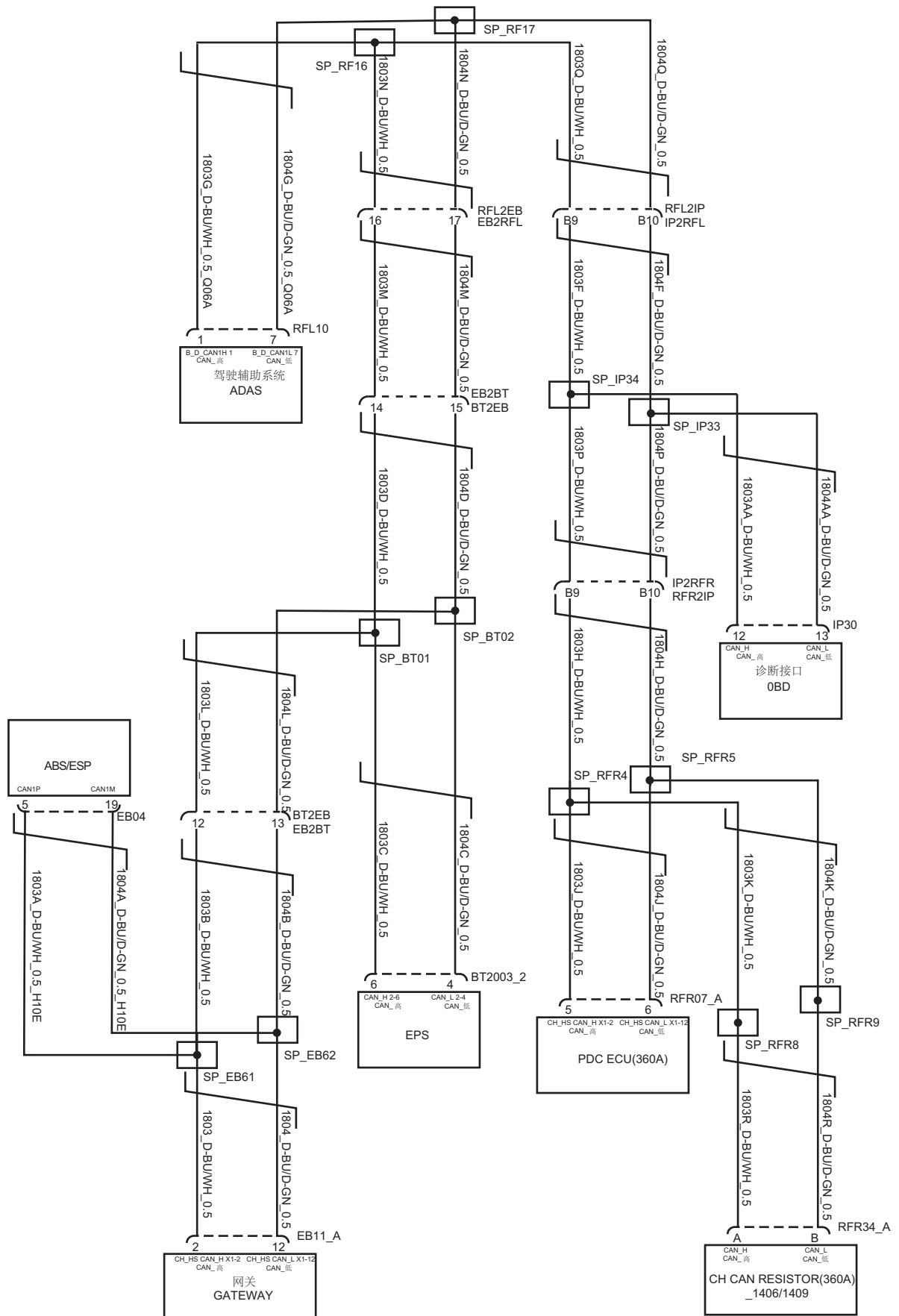

5.34.3 Gateway system 3 - Left Rudder

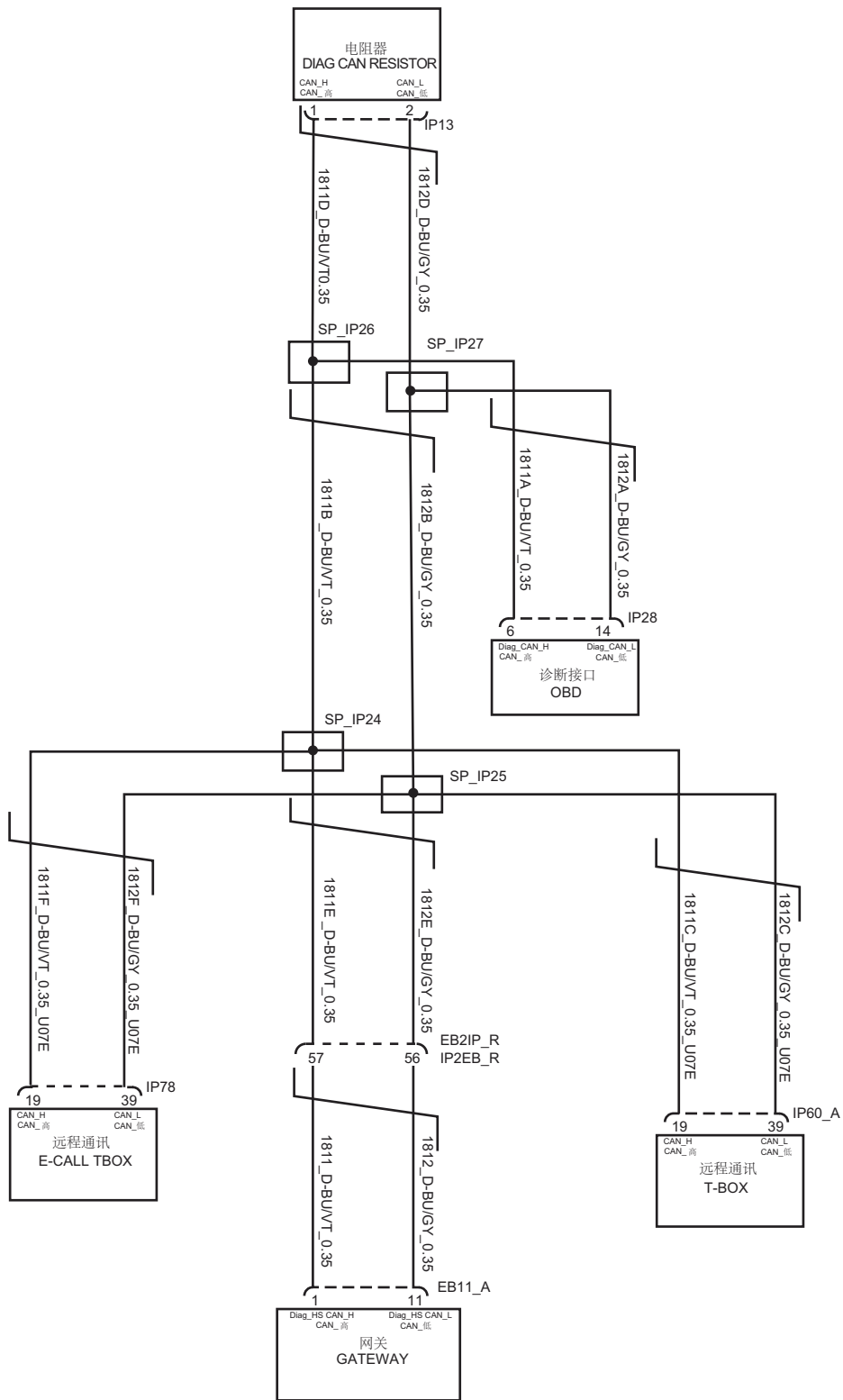

5. 34. 4 Gateway system 4 – Left Rudder

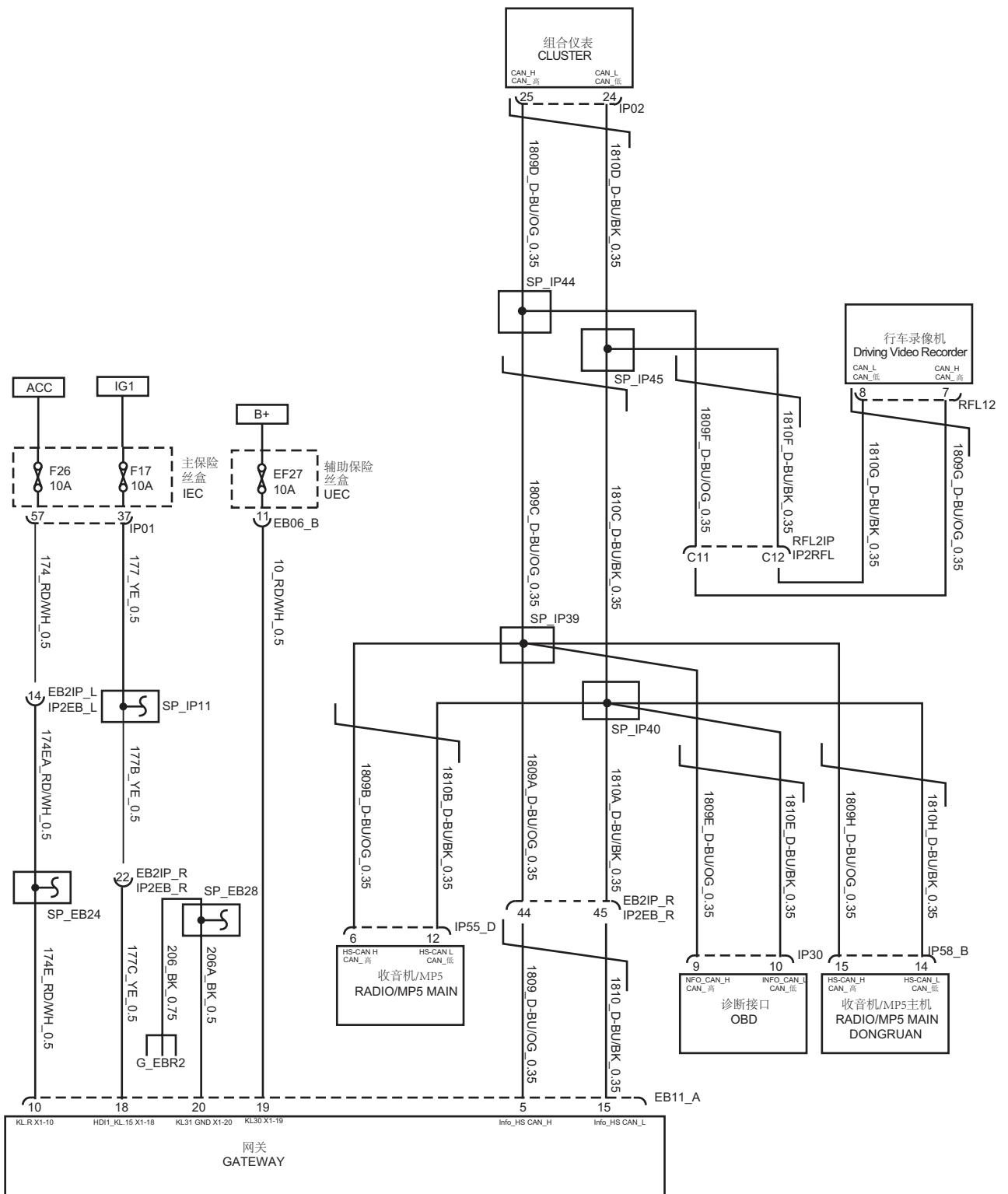

5.34.5 Gateway system 5 - Left Rudder

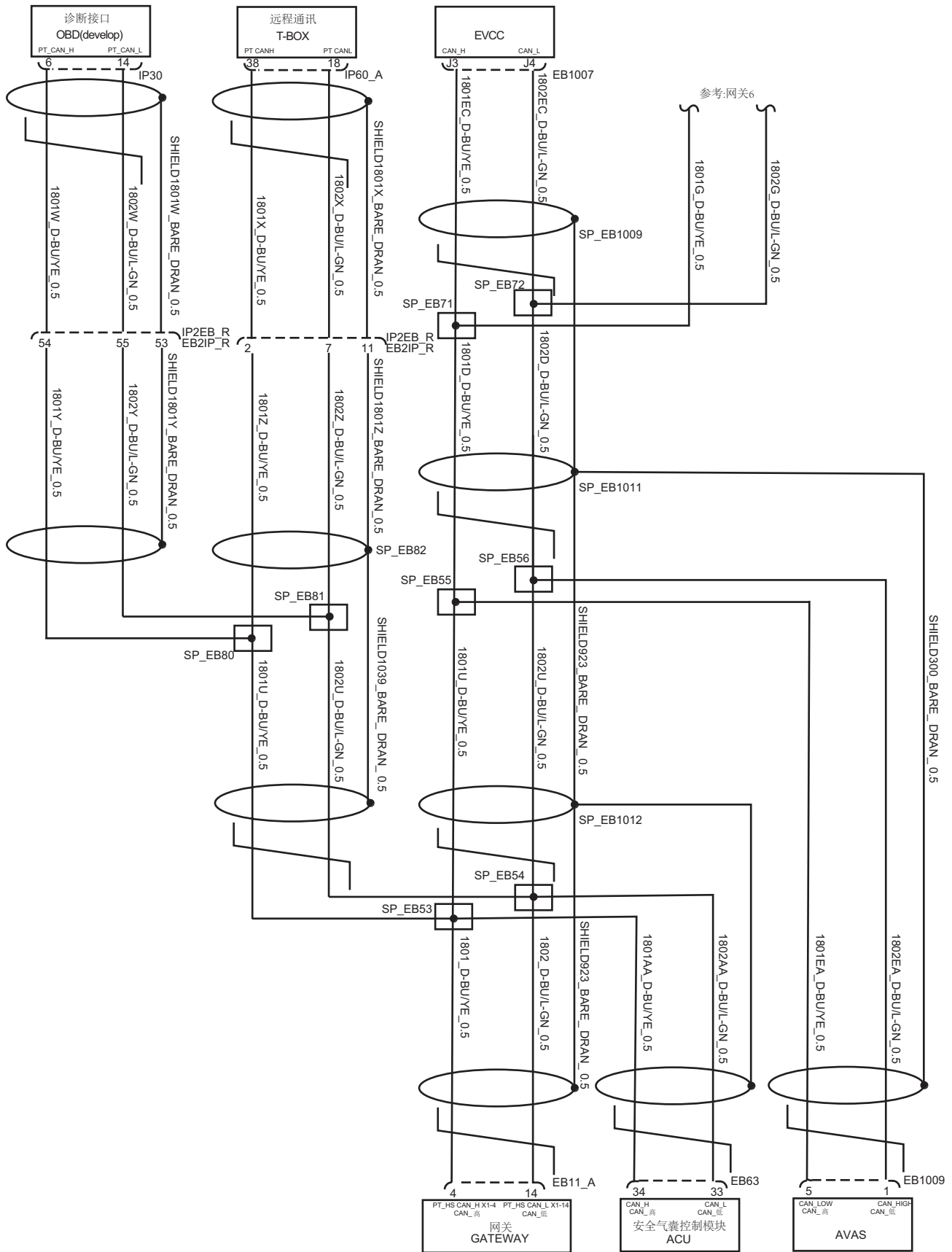

5.34.7 Gateway system 1 - Right Rudder

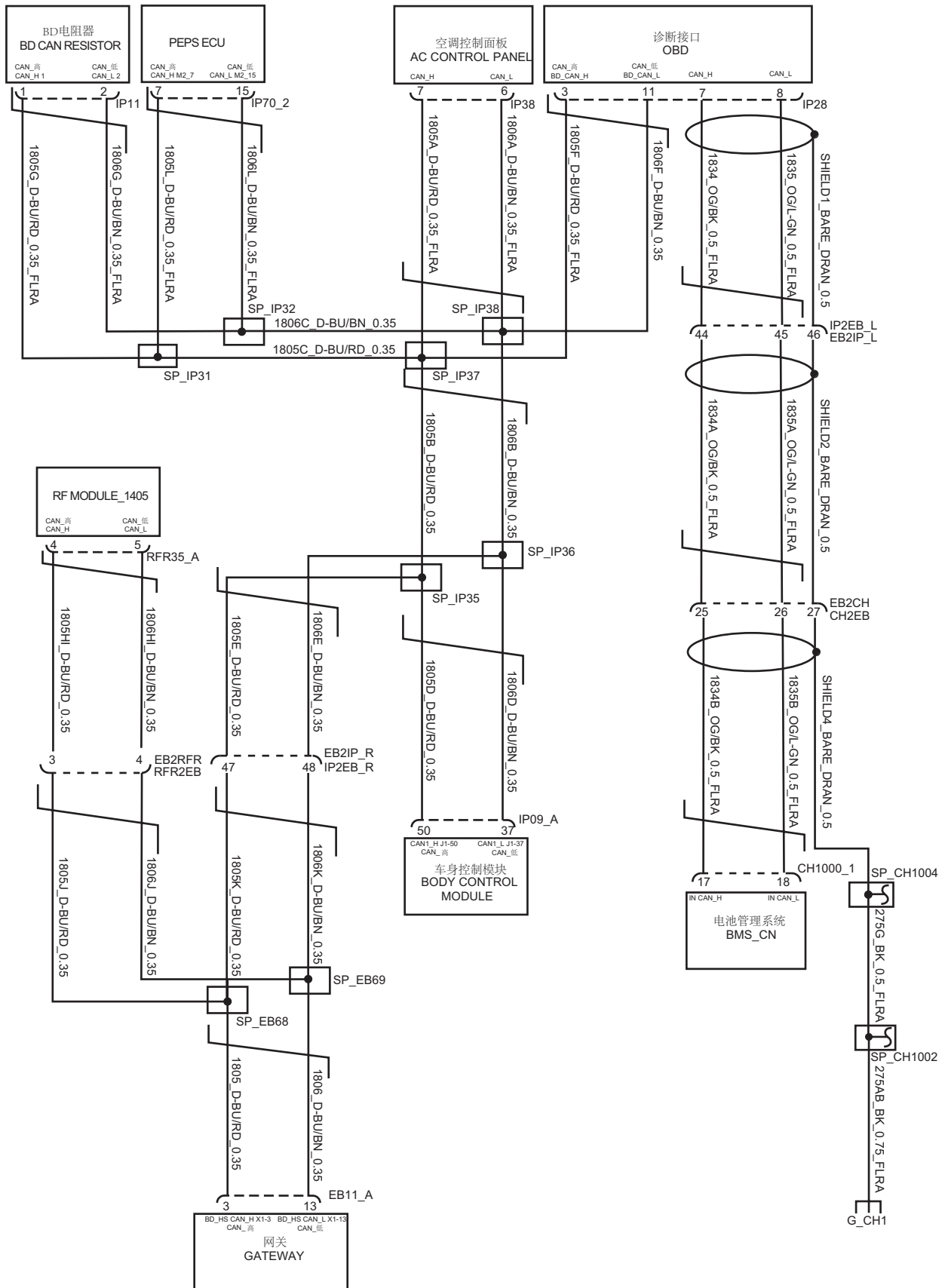

5. 34. 8 Gateway system 2 - Right Rudder

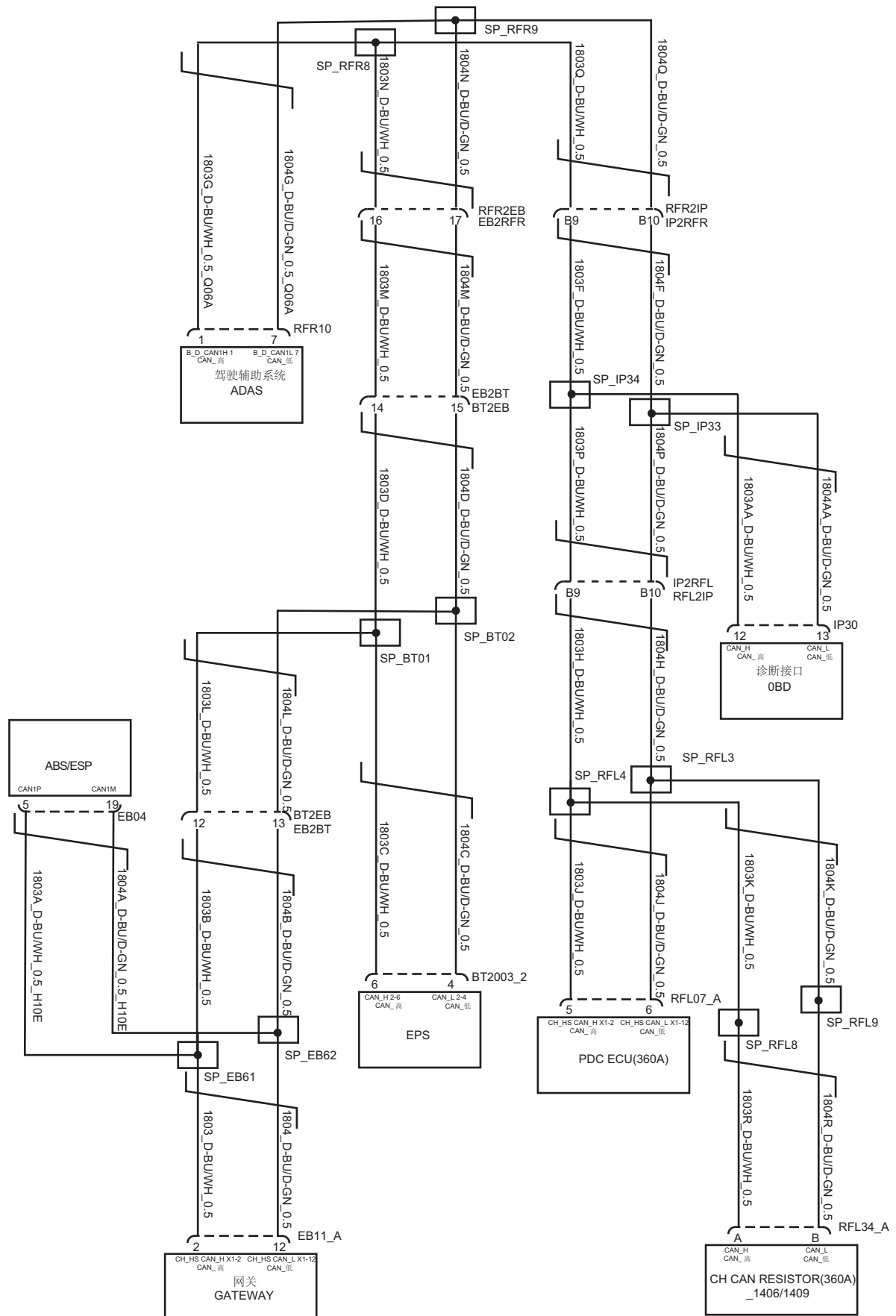

5.34.9 Gateway system 3 - Right Rudder

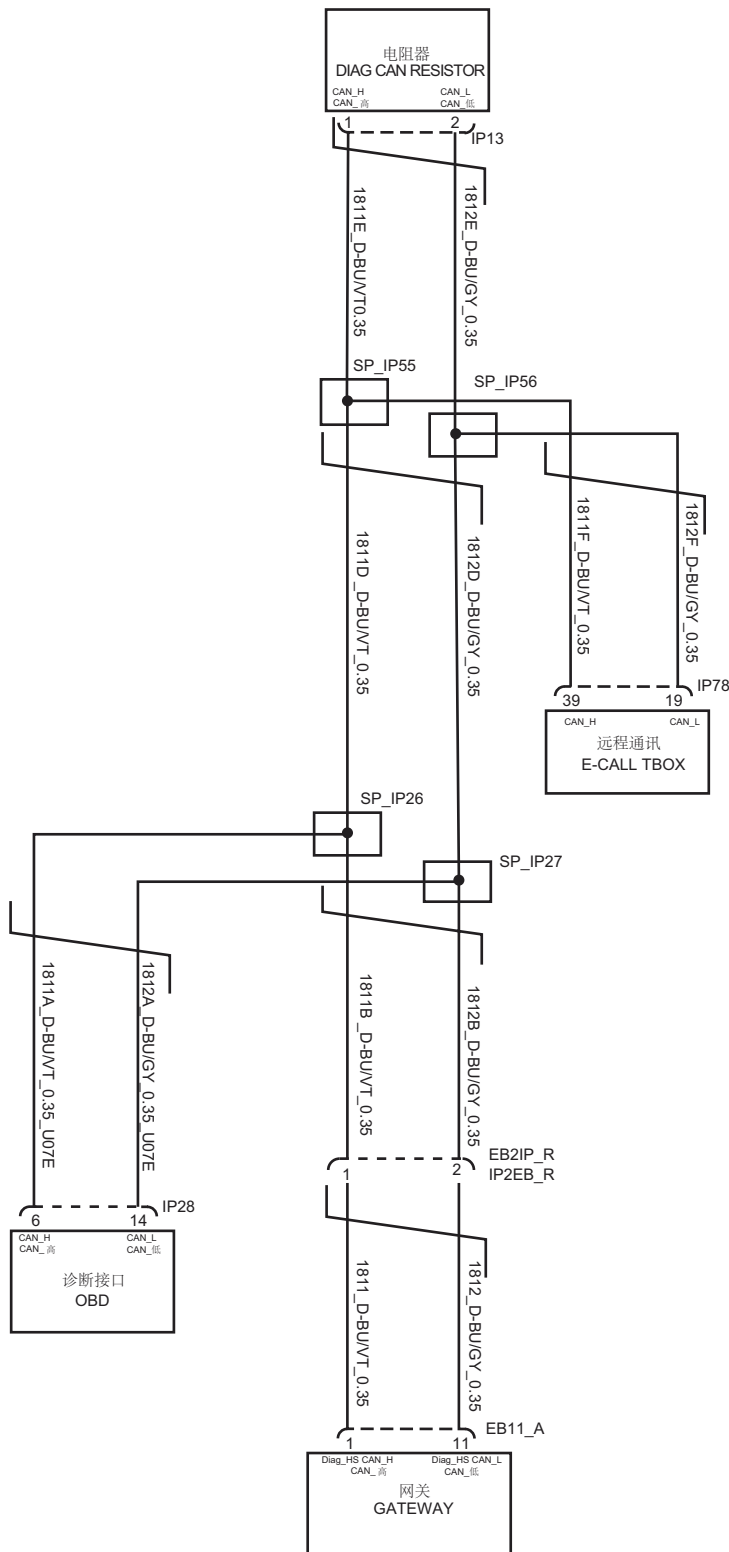

5. 34. 10 Gateway system 4 - Right Rudder

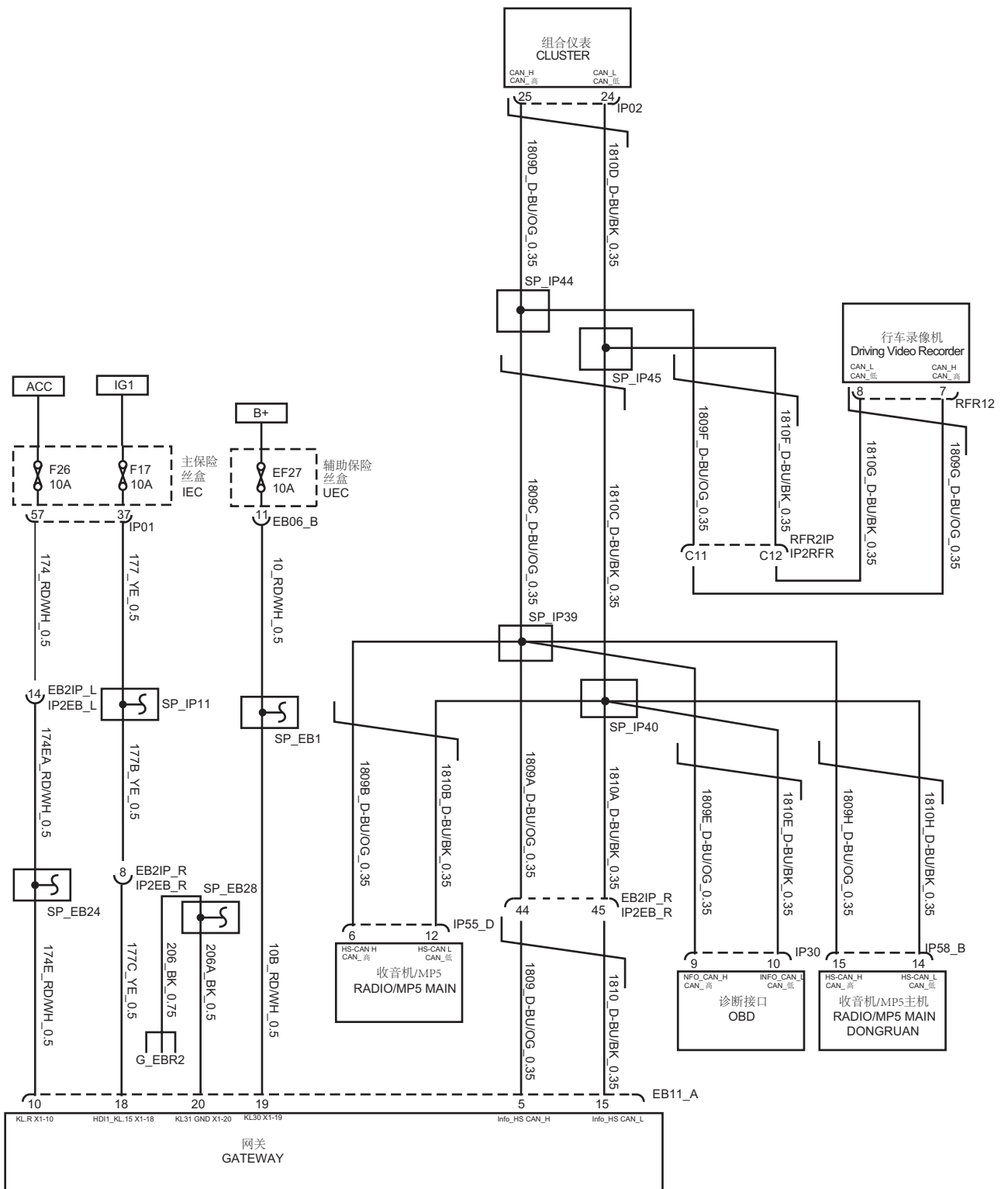

5.34.11 Gateway system 5 - Right Rudder

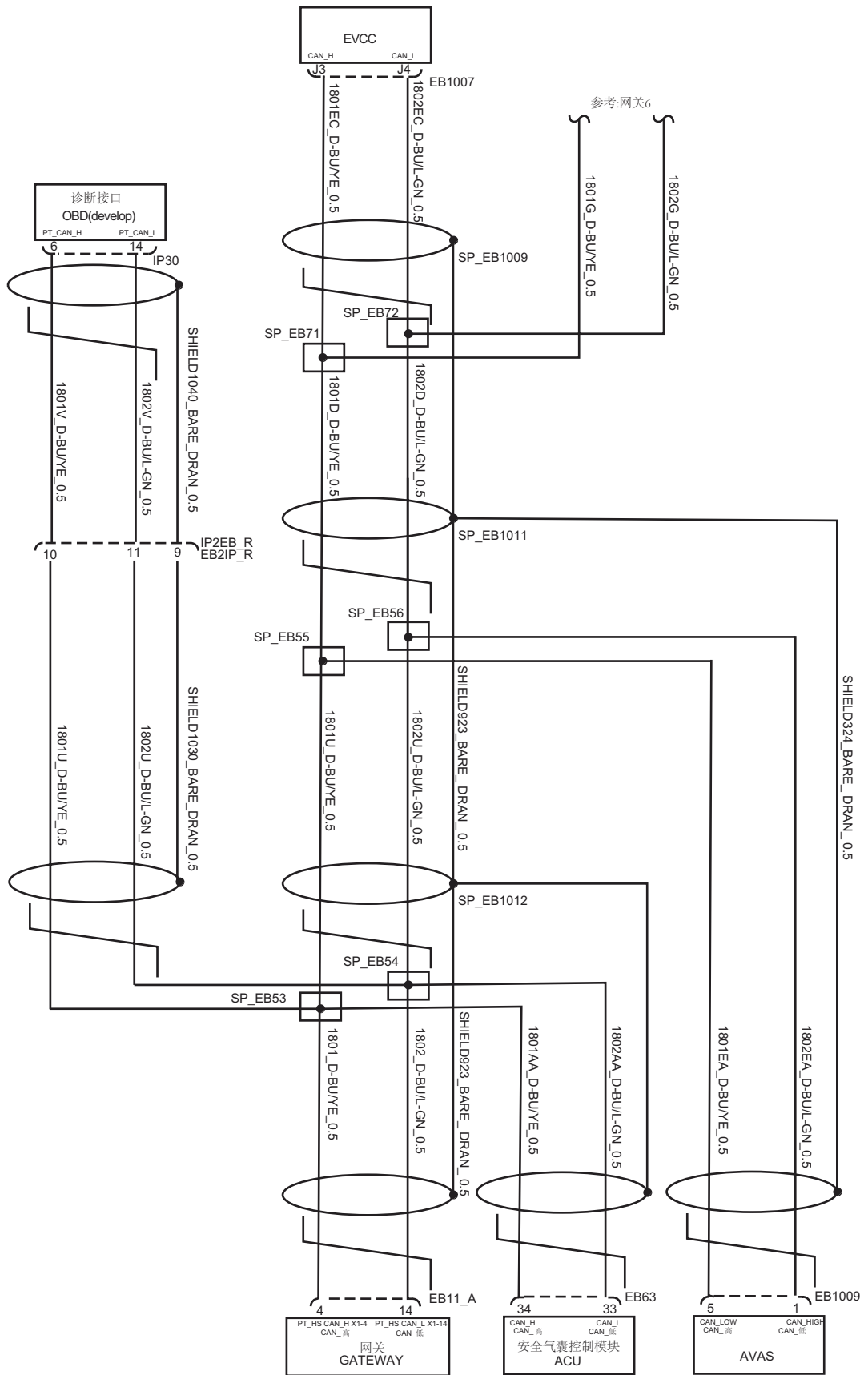

5.35 Grounding

5.35.1 Grounding 1 - Left Rudder

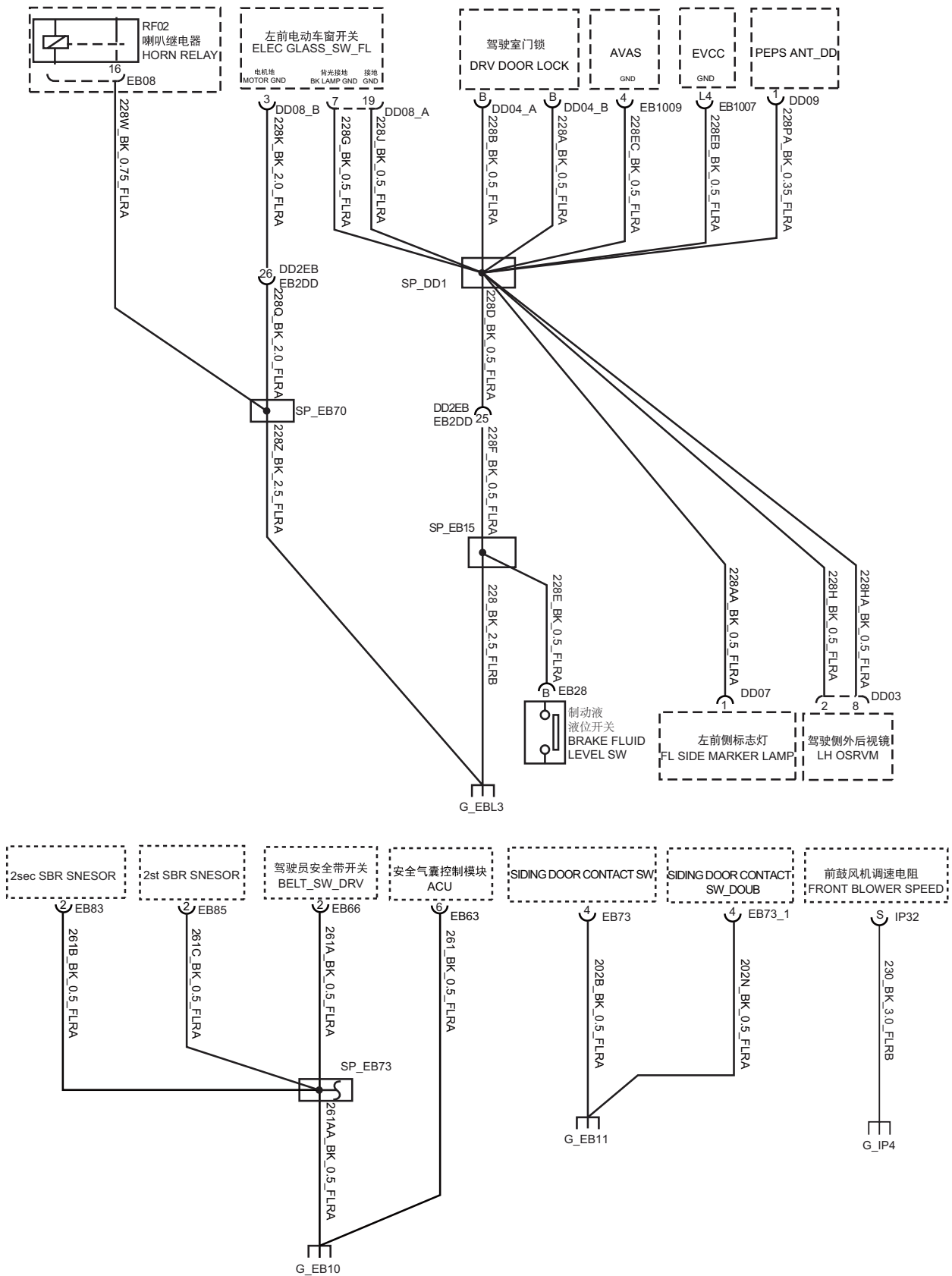

5.35.2 Grounding 1 – Left Rudder

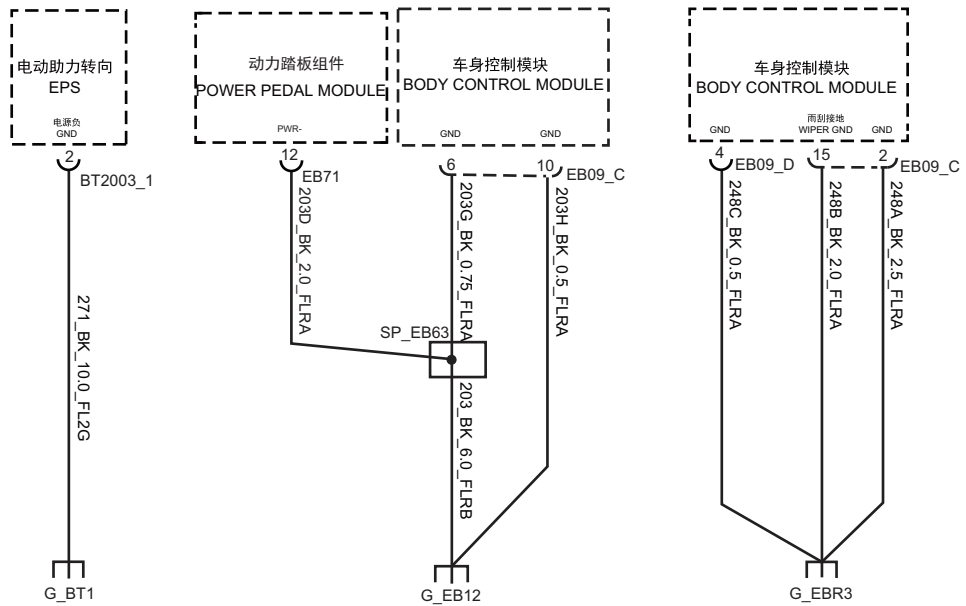
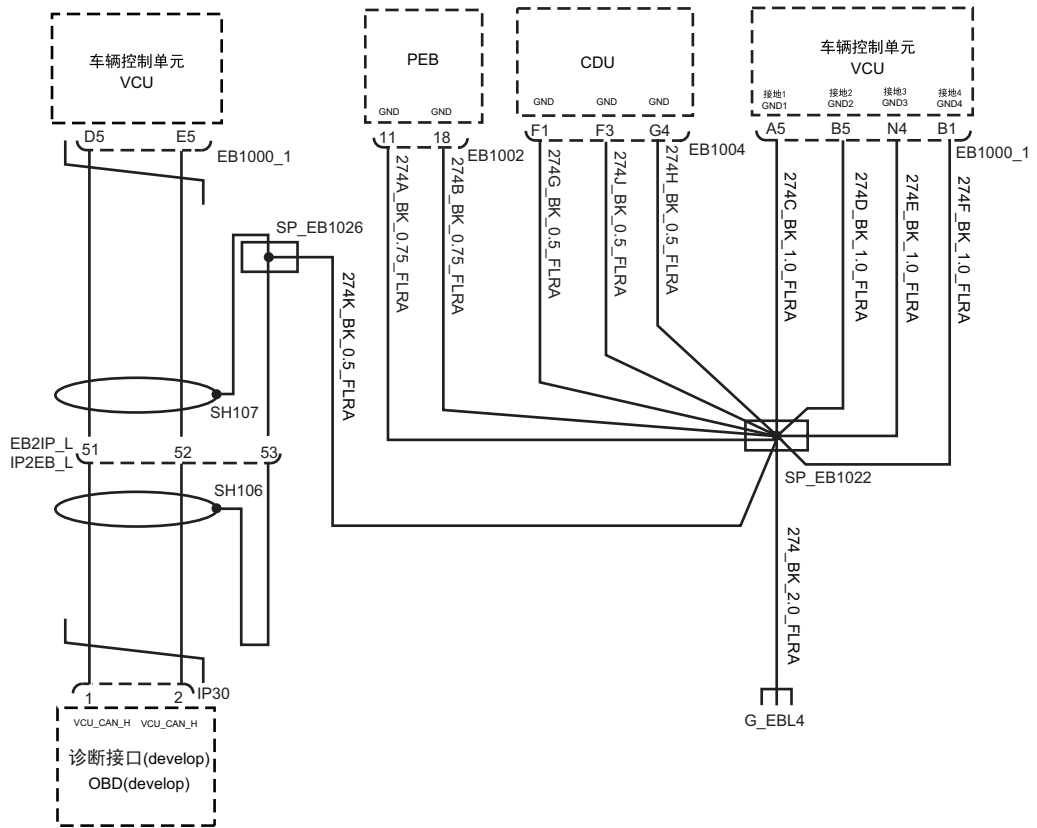

5. 35. 4 Grounding 4 – Left Rudder

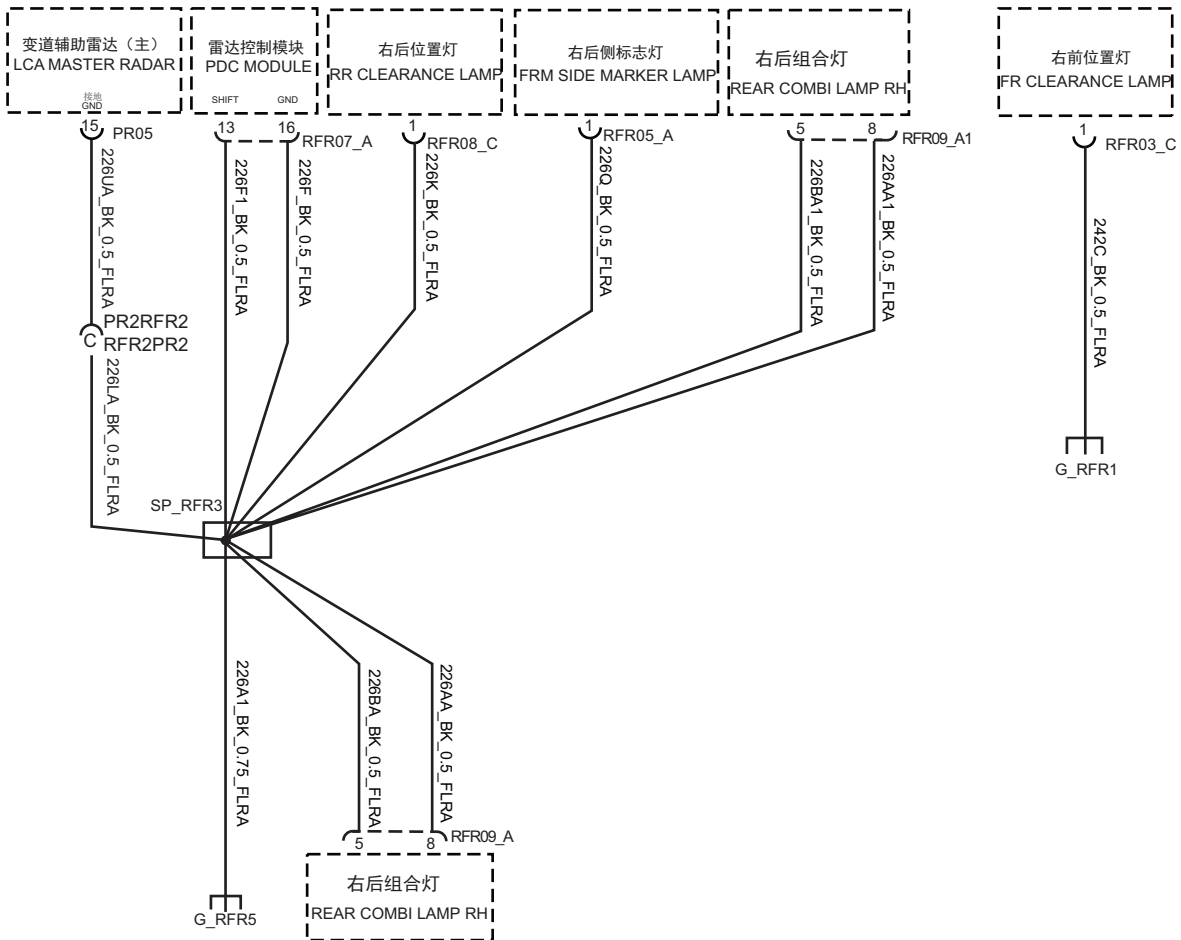
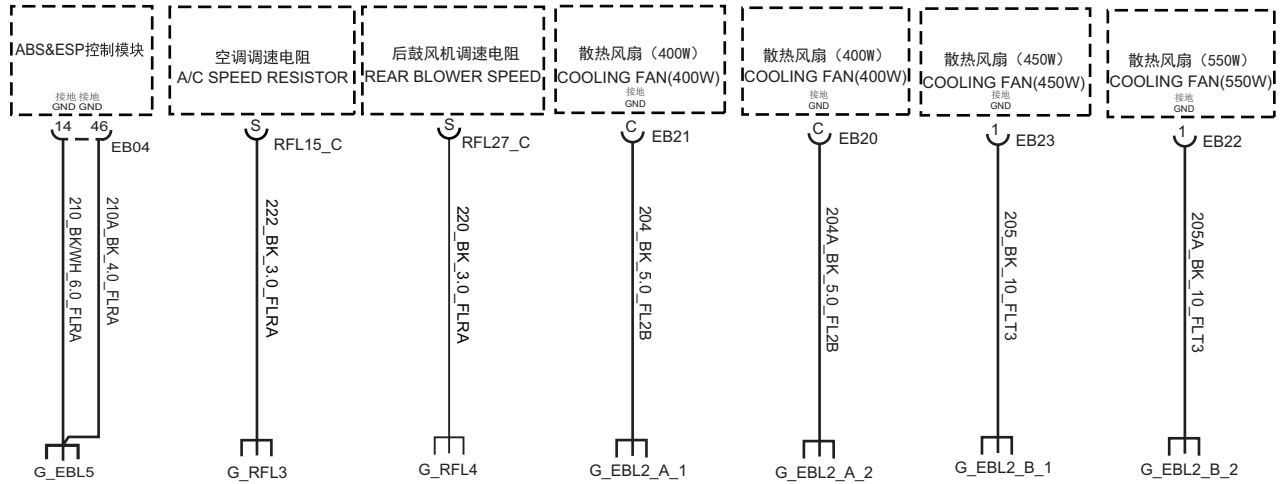

5.35.5 Grounding 5 - Left Rudder

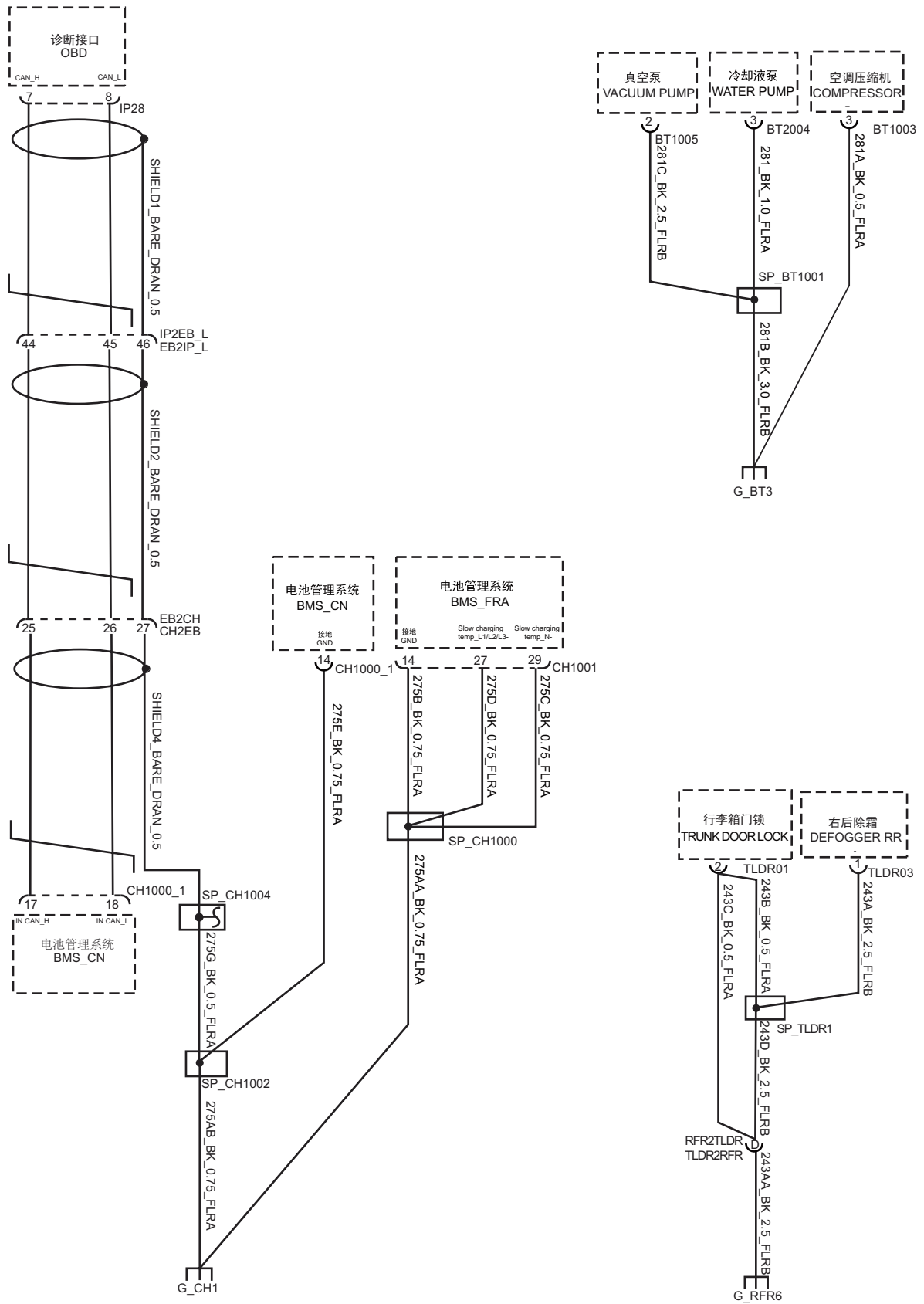

5. 35. 6 Grounding 6 – Left Rudder

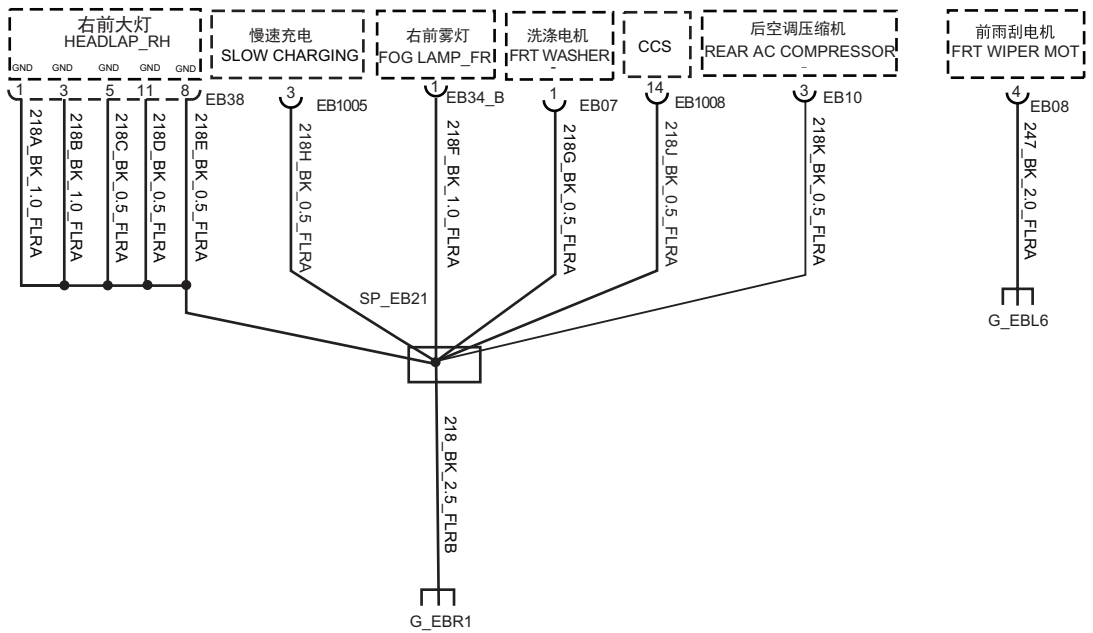
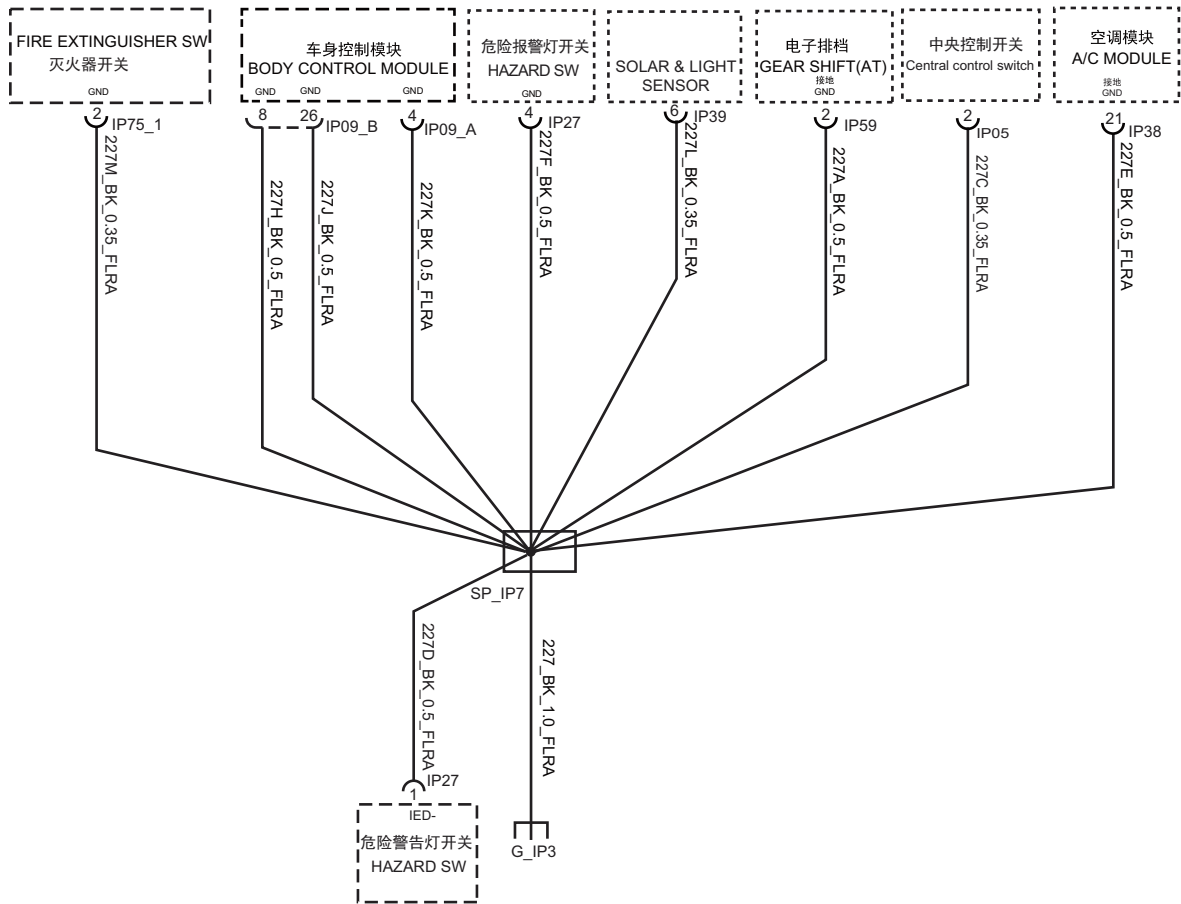

5.35.7 Grounding 7 - Left Rudder

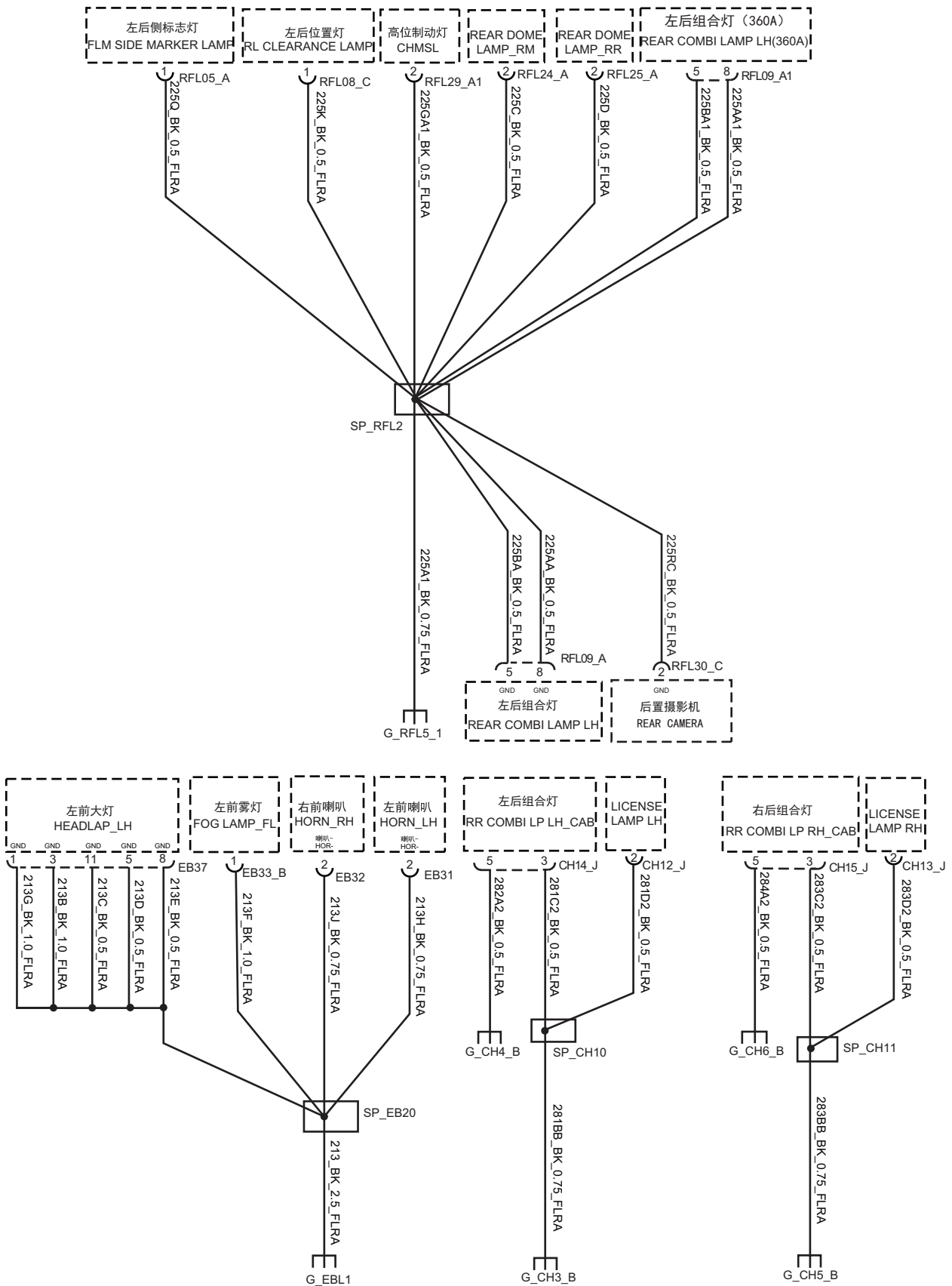

5. 35. 8 Grounding 8 – Left Rudder

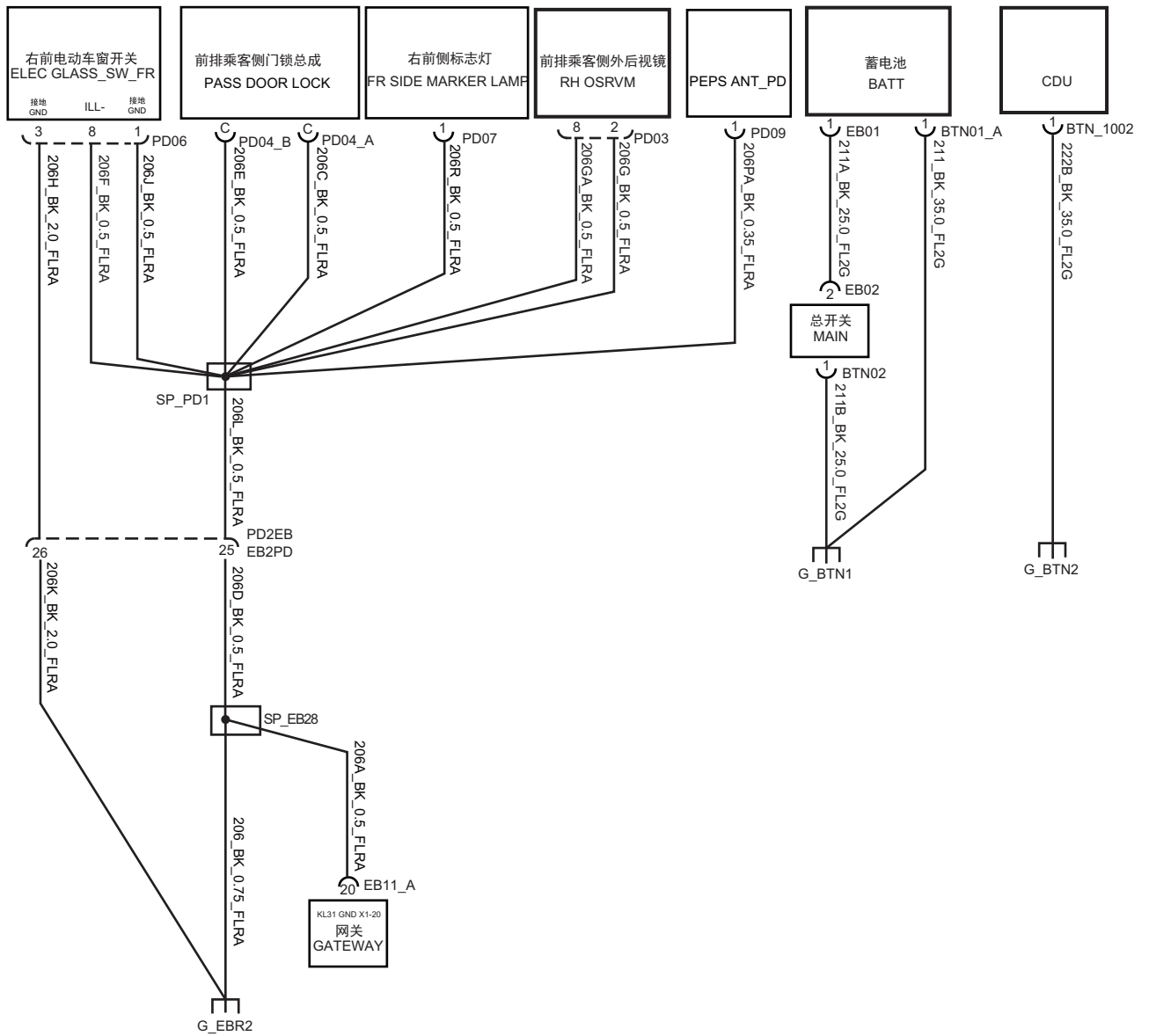

5.35.9 Grounding 9 - Left Rudder

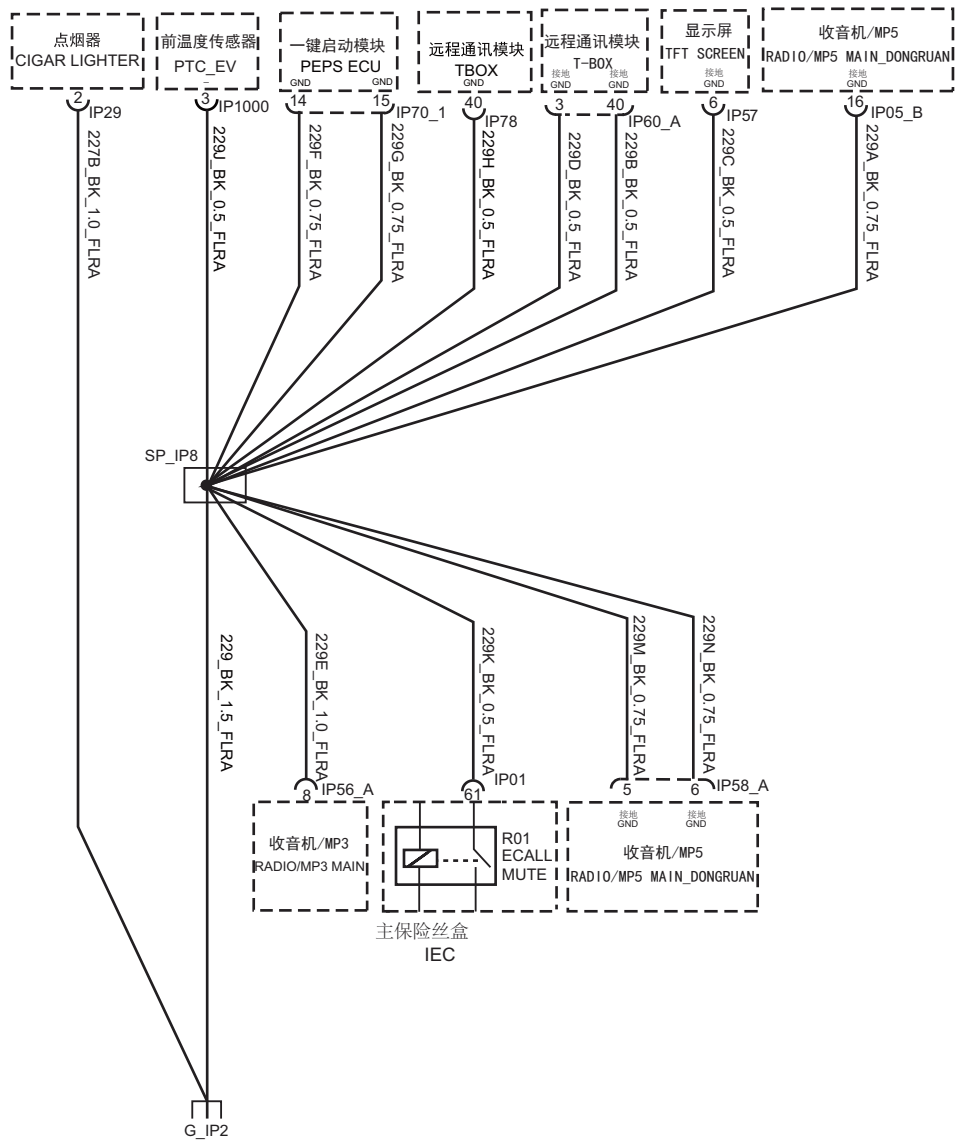

5. 35. 10 Grounding 1 – Right Rudder

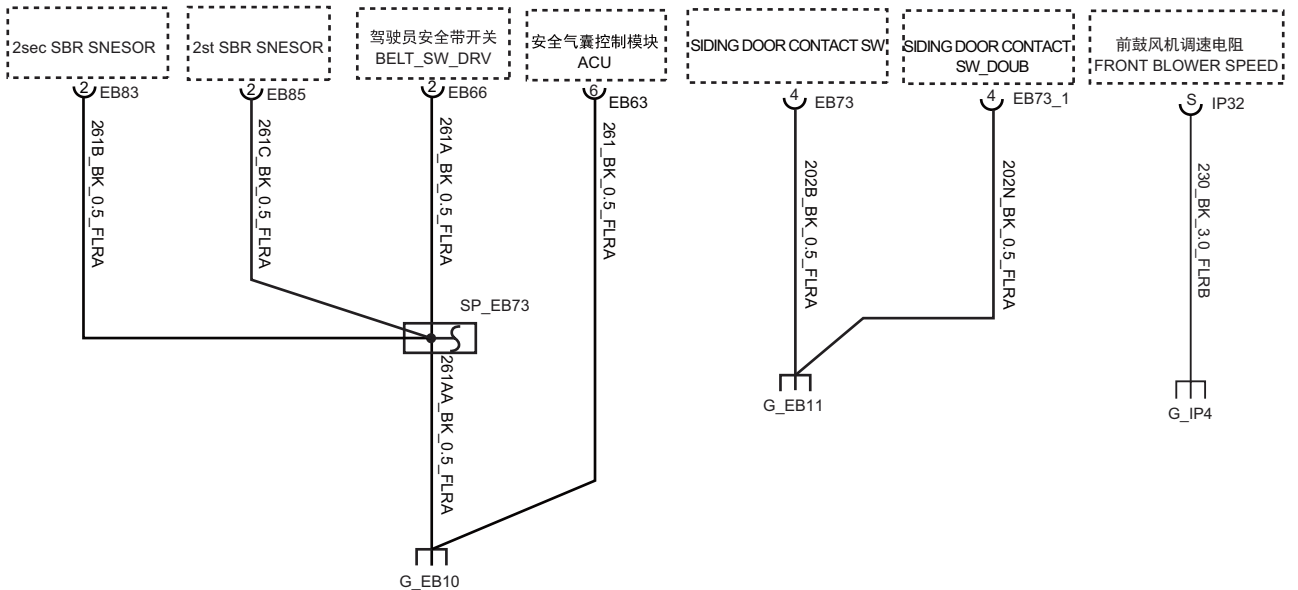
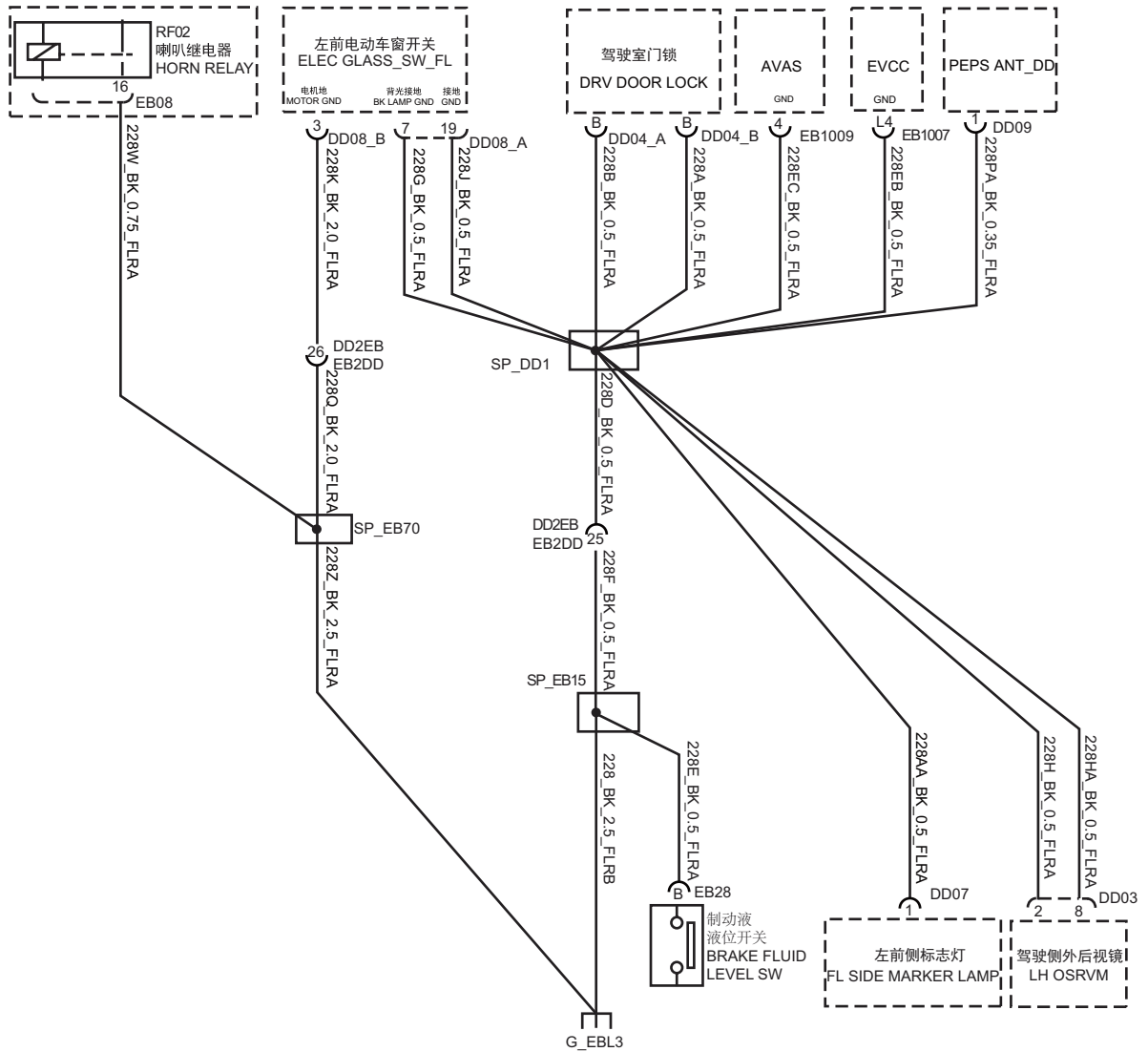

5.35.11 Grounding 2 - Right Rudder

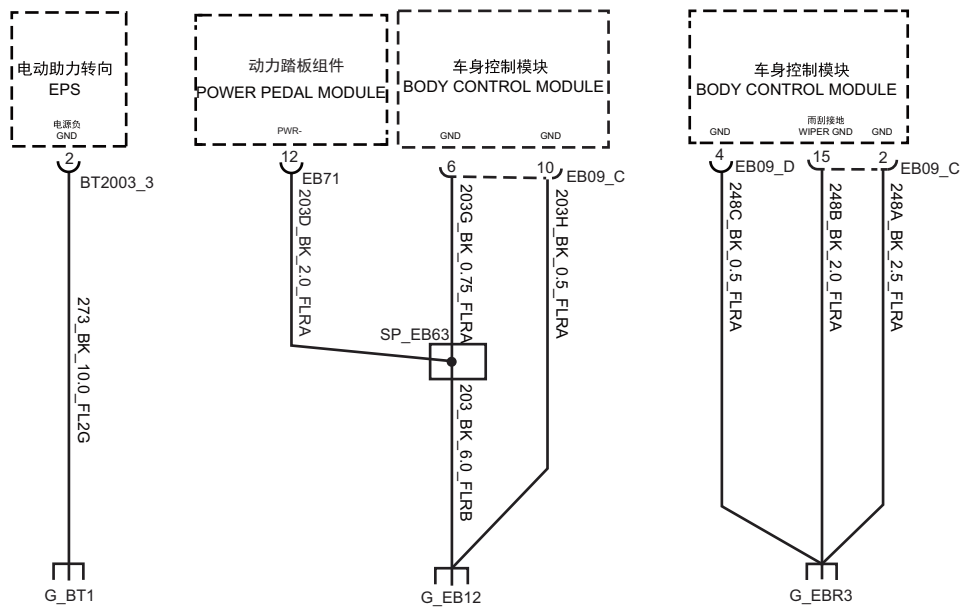
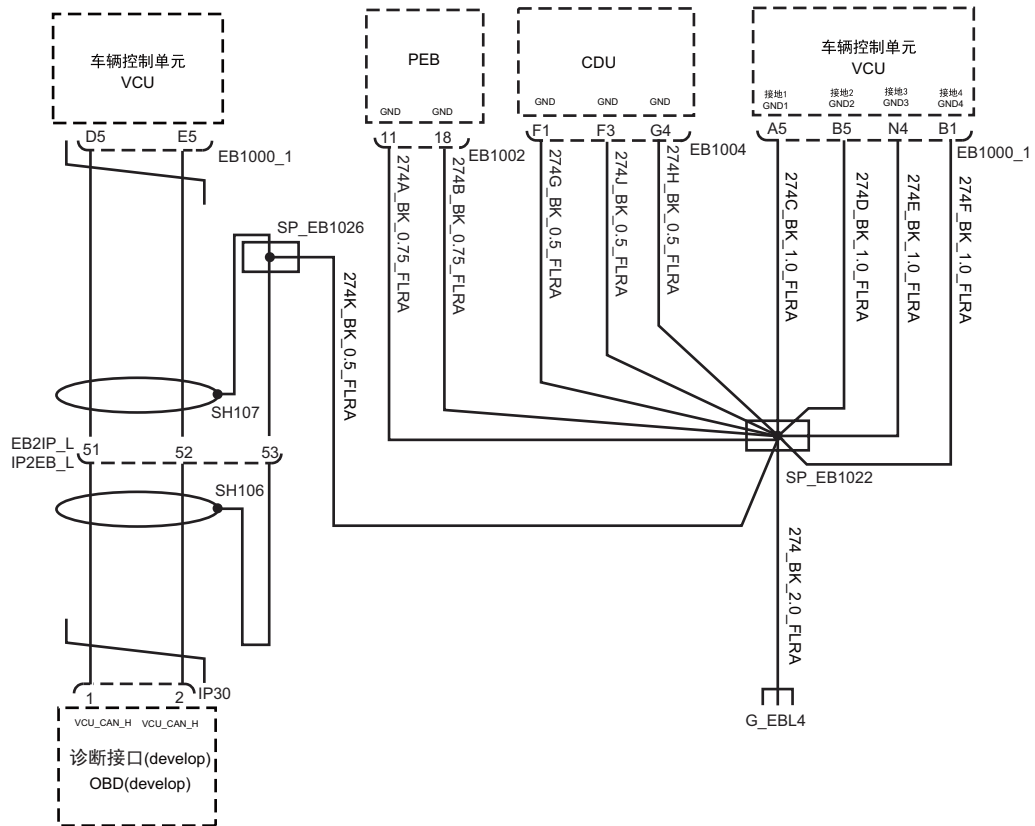

5.35.12 Grounding 3 - Right Rudder

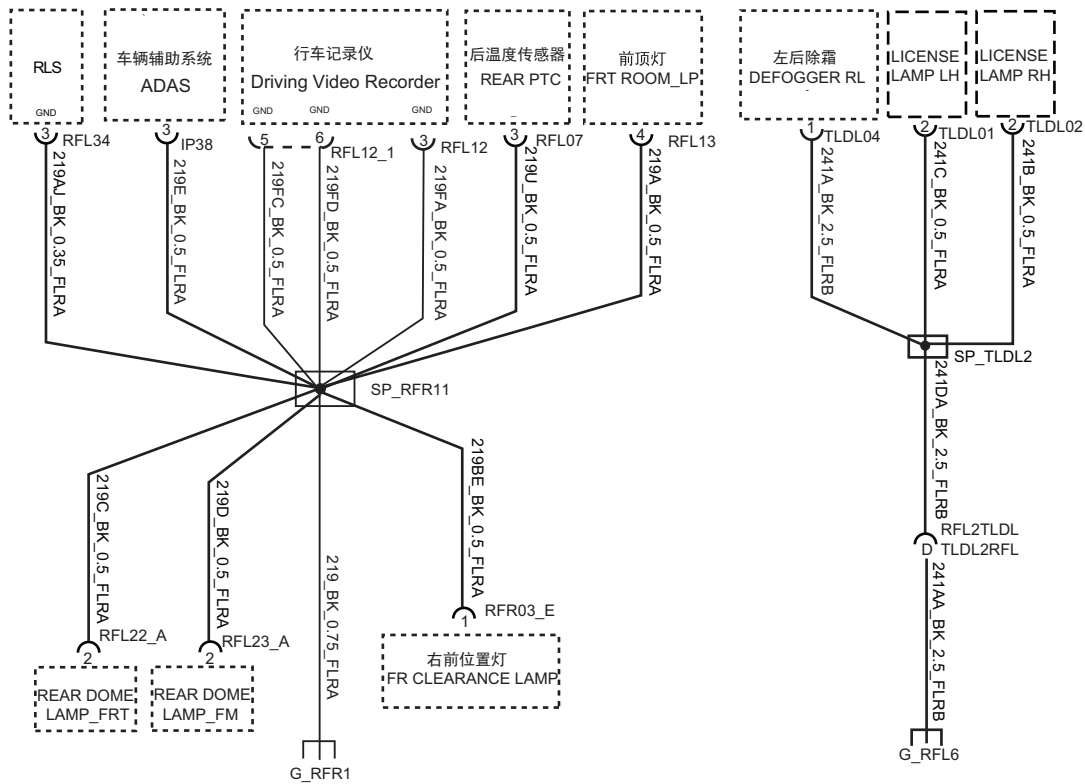
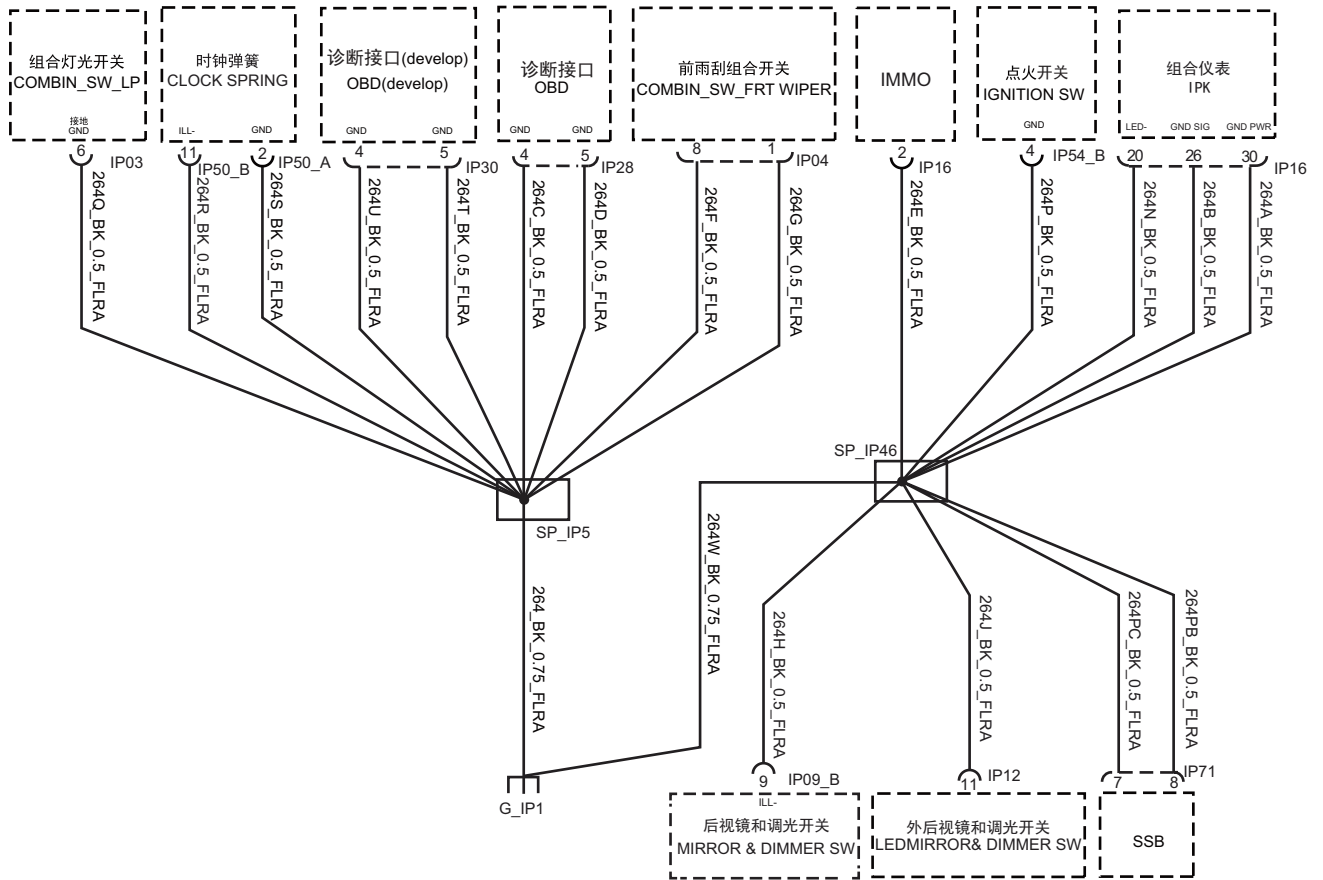

5.35.13 Grounding 4 - Right Rudder

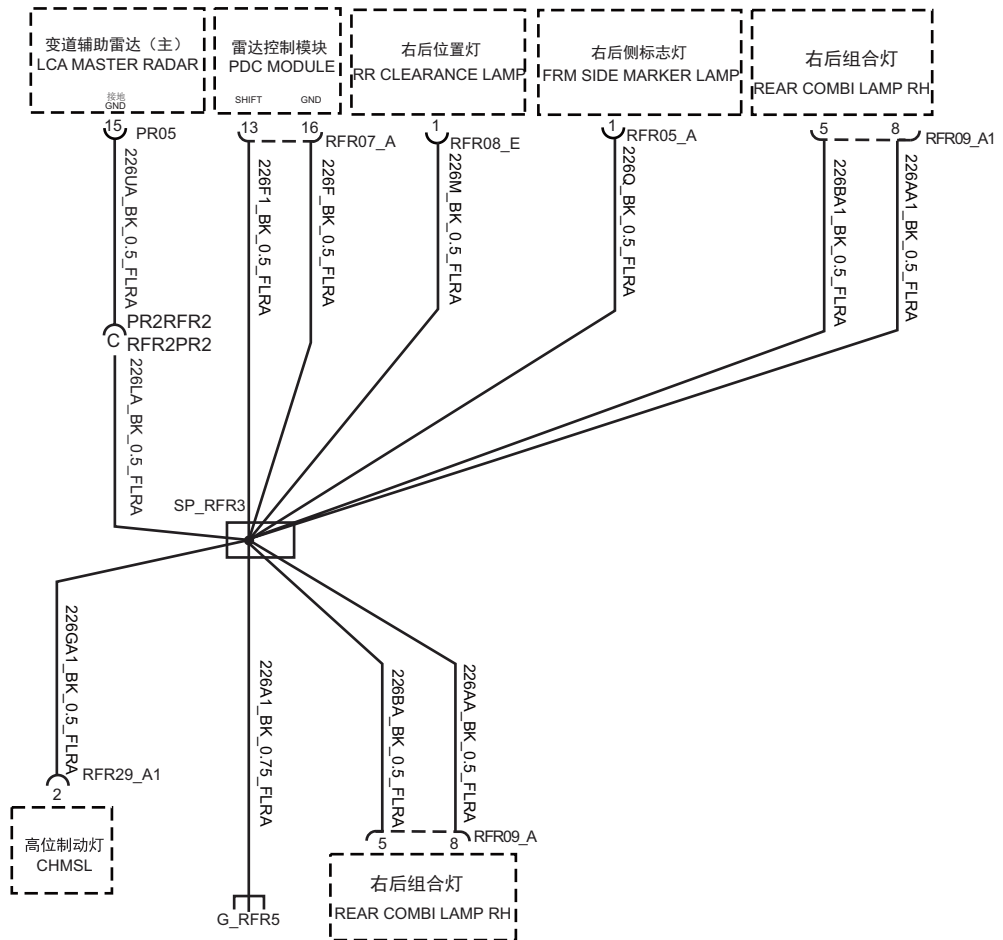
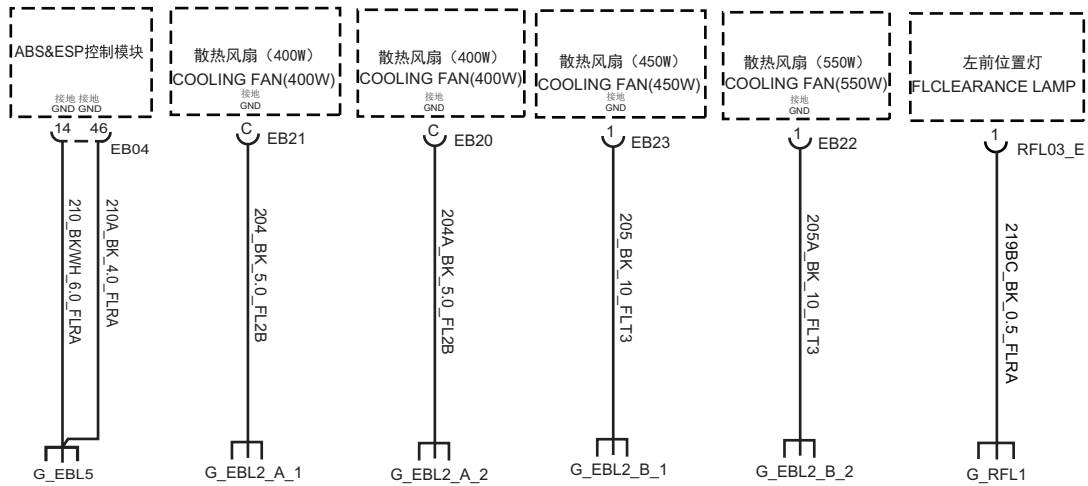

5. 35. 14 Grounding 5 - Right Rudder

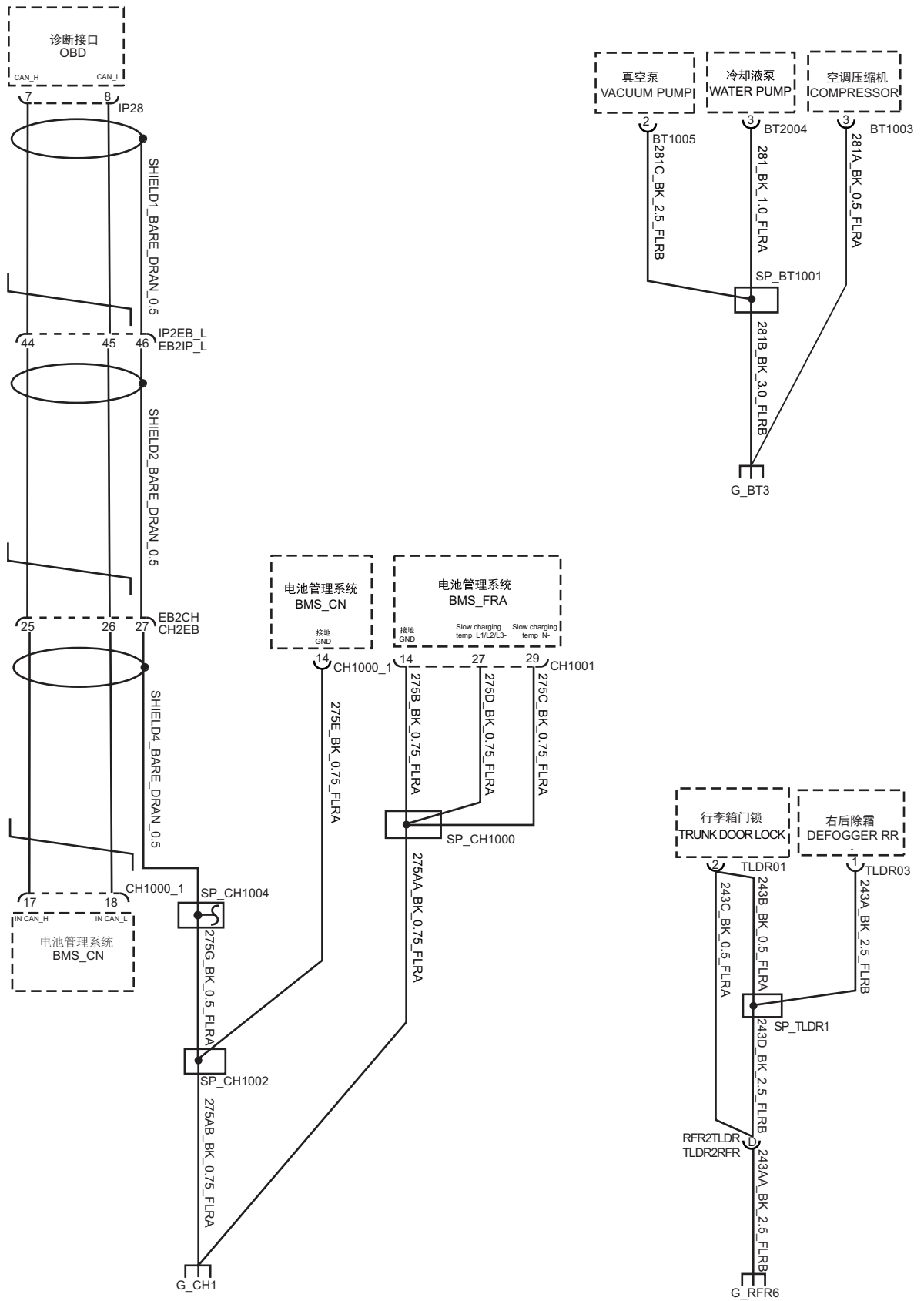

5. 35. 15 Grounding 6 – Right Rudder

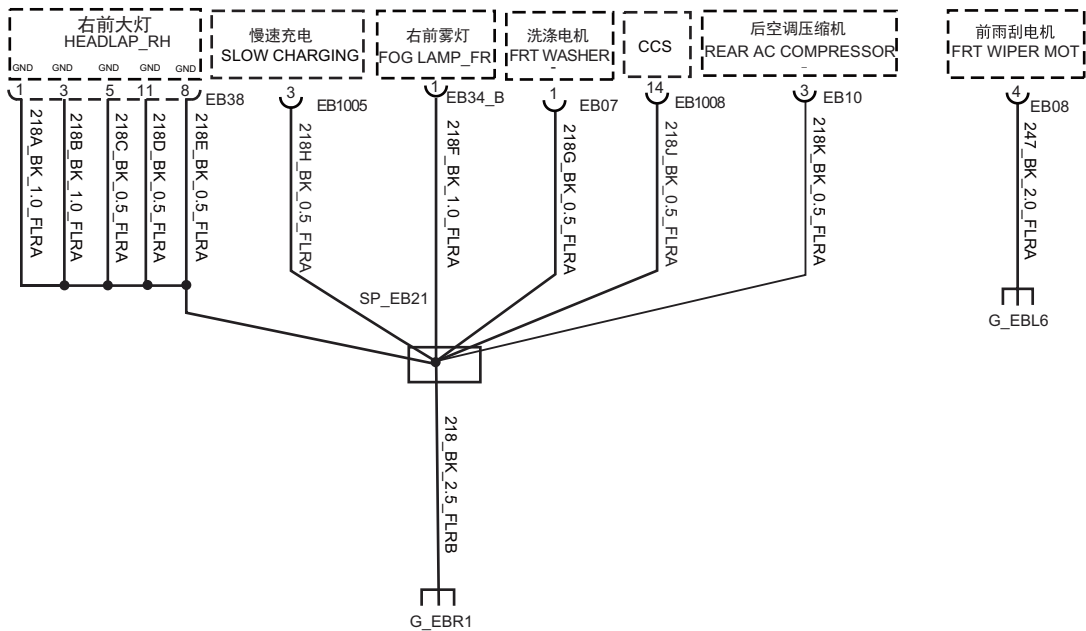
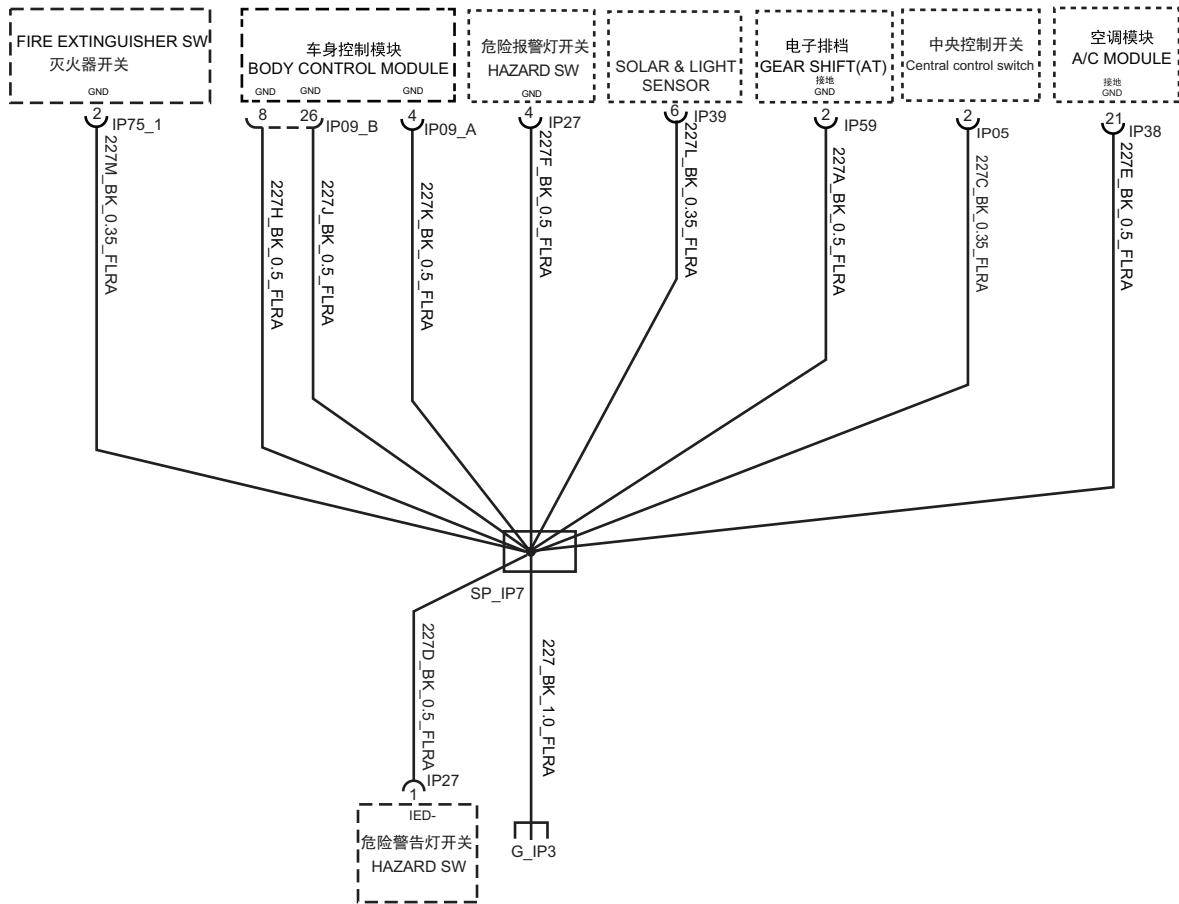

5. 35. 16 Grounding 7 – Right Rudder

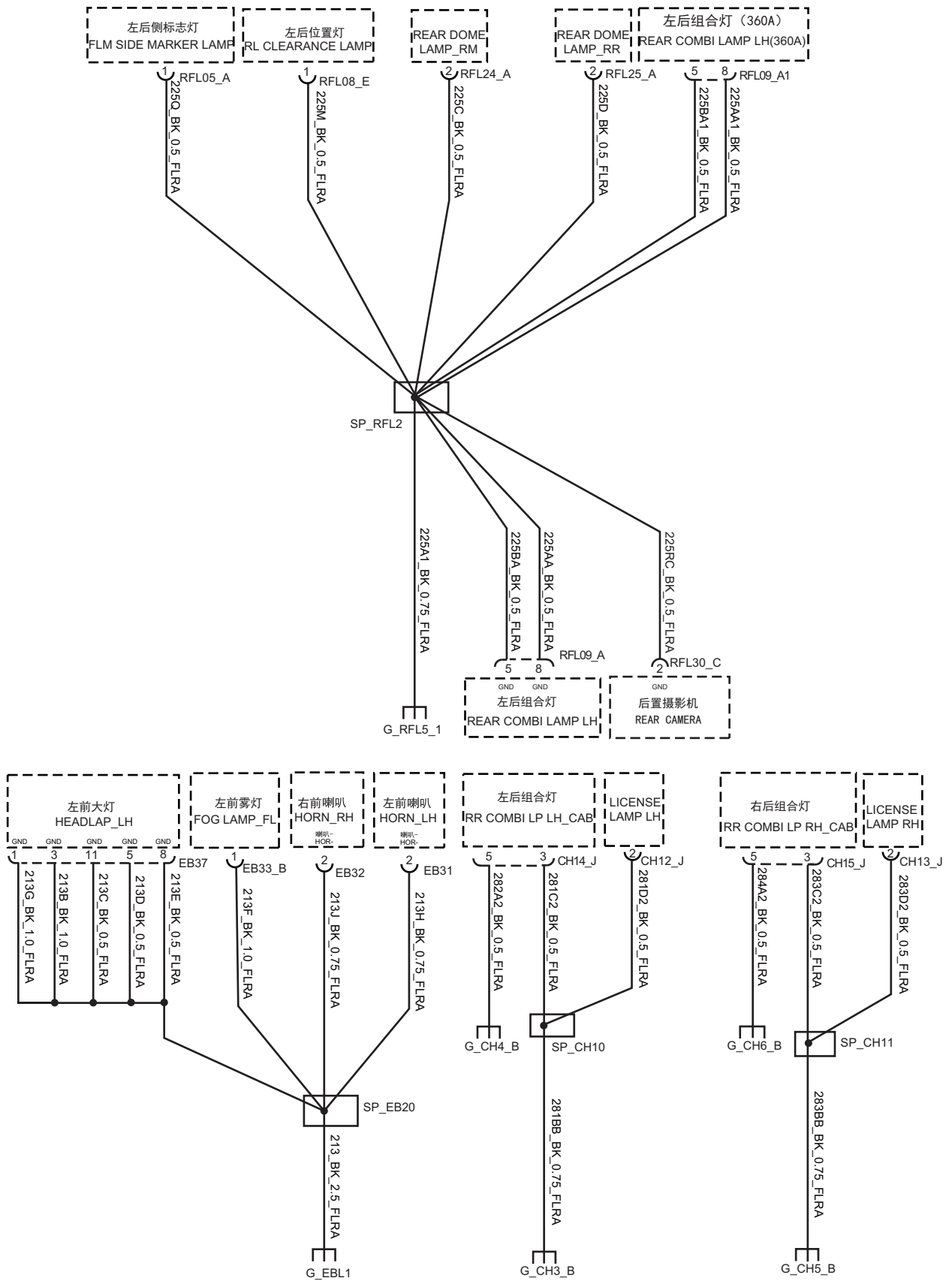

5.35.17 Grounding 8 - Right Rudder

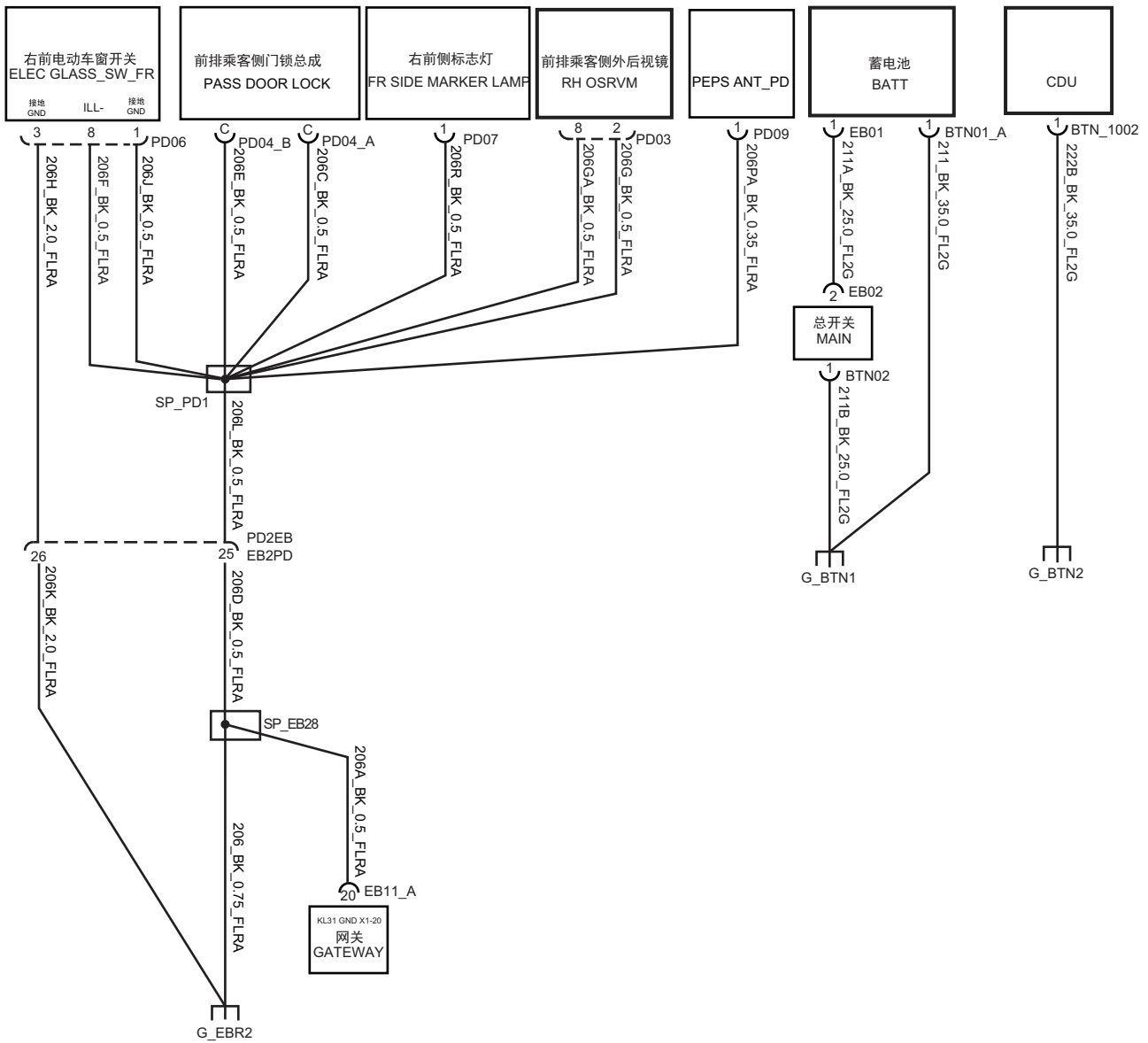

5. 35. 18 Grounding 9 – Right Rudder

