



#### Notes

The Manual defines the agreements between SAIC GM Wuling Automobile Co., Ltd. ① and Owners on establishment and termination of related product quality assurance liabilities, after-sales rights and duties. It helps you understand how to use and maintain the vehicle correctly, and it is a basis for your quality assurance service. Please always read the Manual carefully before using our products.

## Service & Maintenance and Owner's Manual of Baojun 530

Thank you for choosing the vehicle manufactured elaborately by SGMW.

SAIC GM Wuling Automobile Co., Ltd.  
Jan. 2018

①: In the Manual, SAIC GM Wuling Automobile Co., Ltd. is called SGMW or the Company for short.



**SGMW Three-guarantees Certificate Coupon A**

<b>Product information</b>			
Product brand: Baojun	Model:	Vehicle type: multi-purpose passenger car	Vehicle specification: K31
Vehicle identification number (VIN): LZW_____			
<b>Manufacturer information</b>			
Name: SAIC GM Wuling Automobile Co., Ltd.		Post code: 545007	
Add.: 18th Hexi Road, Liuzhou, Guangxi, P.R.China		Service Tel.: 400-86-12345, 400-889-5050	
<b>Seller information (stamp)</b>			
Name:		Post code:	Tel.:
Add.:		Sales date: MM DD YY	
<b>Three-guarantees clauses (count from the invoice date or the current driving mileage, whichever comes first)</b>			
<b>Warranty period of automobile product:</b> 3 years or 60,000 km for whole vehicle			
<b>Three-guarantees validity of automobile product:</b> 2 years or 50,000 km for whole vehicle			
<b>Other Three-guarantees commitments:</b> Please refer to Appendix 1 of the Three-guarantees Certificate for the range of whole vehicle parts and components and Appendix 2 of the Three-guarantees Certificate for the range and quality assurance period of vulnerable parts and components and the range of powertrain parts that enjoy warranty of 5 years or 100,000 km. As for other warranty policies and clauses, please refer to the main body of the Manual.			
<b>Owner information</b>			
Buyer information: <input type="checkbox"/> Natural person <input type="checkbox"/> Legal person			
Name:_____ Tel.:_____ ID/unit contact:_____			
Add.:_____ (detailed address) _____ (city/county) _____ (province/municipality) Owner's signature:_____			

Note: The Three-guarantees Certificate Coupon A shall be kept by the dealer and the Three-guarantees Certificate Coupon B shall be kept by the owner; for information not detailed, the Manual shall prevail.



**SGMW Three-guarantees Certificate Coupon B**

<b>Product information</b>			
Product brand: SGMW	Model:	Vehicle type: multi-purpose passenger car	Vehicle specification: K31
Vehicle identification number (VIN): LZW_____			
<b>Manufacturer information</b>			
Name: SAIC GM Wuling Automobile Co., Ltd.		Post code: 545007	
Add.: 18th Hexi Road, Liuzhou, Guangxi, P.R.China		Service Tel.: 400-86-12345, 400-889-5050	
<b>Seller information (stamp)</b>			
Name:		Post code:	Tel.:
Add.:		Sales date: MM DD YY	
<b>Three-guarantees clauses (count from the invoice date or the current driving mileage, whichever comes first)</b>			
<b>Warranty period of automobile product:</b> 3 years or 60,000 km for whole vehicle			
<b>Three-guarantees validity of automobile product:</b> 2 years or 50,000 km for whole vehicle			
<b>Other three-guarantees commitments:</b> Please refer to Appendix 1 of the Three-guarantees Certificate for the range of whole vehicle parts and components and Appendix 2 of the Three-guarantees Certificate for the range and quality assurance period of vulnerable parts and components and the range of powertrain parts that enjoy warranty of 5 years or 100,000 km. As for other warranty policies and clauses, please refer to the main body of the Manual.			
<b>Owner information</b>			
Buyer information: <input type="checkbox"/> Natural person <input type="checkbox"/> Legal person			
Name: _____ Tel.: _____ ID/unit contact: _____			
Add.: _____ (detailed address) _____ (city/county) _____ (province/municipality) Owner's signature: _____			

Note: The Three-guarantees Certificate Coupon A shall be kept by the dealer and the Three-guarantees Certificate Coupon B shall be kept by the owner; for information not detailed, the Manual shall prevail.



**SGMW Three-guarantees Certificate Appendix 1**

Assembly	Main part	SGMW explanation
Engine	Crankshaft	Crankshaft
	Main bearing	Crankshaft main bearing, bearing bushing and thrust bearing
	Connecting rod	Connecting rod assembly and component
	Connecting rod bearing	Connecting rod bushing, connecting rod bearing shell and connecting rod bearing
	Piston	Piston and piston assembly
	Piston ring	Piston ring
	Piston pin	Piston pin
	Cylinder head	Cylinder head body
	Camshaft	Intake camshaft and exhaust camshaft
	Valve	Intake valve and exhaust valve
Transmission	Cylinder block	Cylinder block body
	Housing	Transmission housing, clutch housing, rear cover, rear housing;
	Gear	Drive gear in transmission; differential in transmission
	Shaft	Propeller shaft in transmission
	Bearing	Propeller shaft bearing in transmission
Steering system	Power drive elements in transmission (incl. clutch, brake)	Synchronizer; clutch disc, clutch friction plate, chain and sprocket of automatic transmission
	Steering gear assembly	Mechanical, hydraulic and electric steering gear
	Steering column	Steering column
	Steering universal joint	Intermediate steering shaft assembly and steering propeller shaft

Assembly	Main part	SGMW explanation
	Steering linkage (excl. ball)	Steering gear inner tie rod and outer tie rod service kit
	Knuckle	Knuckle
Brake system	Brake master cylinder	Brake pump assembly, brake master cylinder assembly and brake master cylinder service kit
	Wheel cylinder	Rear wheel cylinder, brake wheel cylinder, front brake caliper and rear brake caliper
	Booster	Vacuum booster assembly and brake master cylinder booster
	Brake pedal and bracket	Brake pedal and pedal bracket
Front/rear axle	Axle housing	/
	Main reducer and differential	/
	CV joint	CV joint, constant velocity joint and drive shaft
	Propeller shaft	/
Suspension system	Spring	Various springs, front stabilizer and stabilizer connecting rod
	Control arm	Front lower rocker arm, swing arm and ball pin assembly, control arm, front lower longitudinal rail and tie rod assembly
	Connecting rod	Rear axle assembly and twist beam assembly
Body	Body frame	BIW assembly
	Subframe	Subframe, engine support and transmission support
	Longitudinal rail	Front/rear longitudinal member, side rail, longitudinal floor rail and sill beam inner plate
	Crossmember	Front/rear crossmember and floor crossmember
	Front and rear doors	Front/rear doors and liftgate

**SGMW Three-guarantees Certificate Appendix 2**

Range and quality assurance period of vulnerable parts and components		
Vulnerable parts and components	Quality assurance period	
	Warranty period	Three-guarantees validity
Air cleaner element, air conditioner filter element, oil filter, fuel filter, tire, wiper blade, fuse and common relay (excl. integrated control unit)	3 months or 5,000 km	None
Brake lining, spark plug, (manual) clutch friction plate, bulb, remote control battery	6 months or 10,000 km	
Battery	12 months or 20,000 km	
<b>Range of powertrain parts that enjoy warranty of 5 years or 100,000 km</b>		
<b>Engine:</b> cylinder block, cylinder head, crankshaft, connecting rod, valve guide pipe, camshaft, oil pump, timing sprocket, timing chain, timing belt pulley, intake/exhaust manifold, piston, oil pan, camshaft/crankshaft bearing cap, flywheel		
<b>Manual transmission:</b> housing, gears, shafts, synchronizer, shift fork/lever		

Compensation coefficient and calculation formula of returned/replaced vehicle:  $[(\text{vehicle price (RMB)} \times \text{total mileage (km)})/1000] \times 0.8\%$

Range of special parts and components customized as per vehicle identification number (VIN): none



---

## Contents

Preface .....	2
Keys, Doors and Windows .....	5
Seats and Protective Devices.....	23
Storage .....	42
Instruments and Controls .....	49
Lighting .....	85
Driver Information and Entertainment.....	91
HVAC.....	95
Driving and Controls .....	109
Vehicle Service & Maintenance .....	125
Technical Data.....	162
Accessory List.....	177
Maintenance Procedures.....	180

## Preface

The vehicle is integrated with advanced technologies, safety, environmental protection and economy.

The Manual provides necessary information to help you drive your vehicle safely and effectively.

The driver shall always note that improper operation of vehicle may cause accidents and injury risks. Moreover, you shall comply with the requirements in laws and regulations of the country. If these requirements are different from those in the Manual, the requirements in the laws and regulations shall prevail.

The staff of SGMW Aftersales Service Center<sup>®</sup> all received professional trainings and can provide complete and satisfactory service for you. Please contact a nearby Service Center if you vehicle needs maintenance or repair. Please refer to the Subsection "Inquiry Way of Aftersales Service Center Contact" in the Section "Maintenance Procedures" for details of Service Center Contact.

Please carry the Manual with your vehicle for review and reference at any time. If you want to resell the vehicle, please hand the Manual over to the new owner along with the vehicle for use by the new owner when needed.

### How to Use the Manual

- The contents at the beginning of the Manual and each section are used for locating specific information.
- As for directional data such as front, rear, left and right, the driving direction shall be taken as the front.
- Some functions described in the Manual may not be configured for all models, and the Manual may introduces some devices/functions that are not installed on your vehicle.
- The Manual includes the latest information available at the time of printing the Manual. The Company has the full authorities to take charge of the amendment to and statements on the Manual and reserves the right to make changes to the product without further notice after the Manual is printed. Some of pictures in the Manual are illustrations only for your reference. Please refer to real objects if pictures are not consistent with real objects.

### Prompts

#### Note

**The content marked with "Note" indicates matters need to be noted during vehicle operation. Ignoring such information may lead to wrong operation.**

#### Warnings

**The content marked with "Warnings" indicates risks of accidents or injuries. Ignoring such information may lead to injuries.**

#### Caution

**The content marked with "Caution" indicates possibility of vehicle damage. Ignoring such information may lead to vehicle damage.**

#### Dangers

**The content marked with "Dangers" indicates risks of fatal injuries. Ignoring such information may endanger lives.**

"\*": asterisk behind a title or text

"\*" indicates that the equipment mentioned is optional, and your vehicle may not have such equipment. Please refer to the actual vehicle for vehicle configuration.

SAIC GM Wuling Automobile Co., Ltd. reserves the copyright of the Manual.

②: In the Manual, the Aftersales Service Center of SAIC GM Wuling Automobile Co., Ltd. is called Aftersales Service Center or Service Center for short.

## Quick Guide

• Remote Control.....	7	• Air Conditioning.....	98
• Passive Entry Passive Start (PEPS) System*.....	13	• Start and Operation.....	111
• Outside Rearview Mirror.....	15	• MT Transmission *.....	117
• Windows.....	17	• Brake.....	118
• Sunroof*.....	19	• Fuel.....	123
• Child Seat.....	33	• Wheels and Tires.....	147
• Air Bag System.....	35	• Jump Start (Dead Battery).....	154
• Instrument Panel.....	50	• Vehicle Traction.....	155
• Warning Lamps, Gauges and Indicators.....	55	• Vehicle Data.....	165
• Reverse Sensor*.....	82	• Accessory List.....	178
• Parking Assist System*.....	84	• Warranty.....	182
• Outside Lighting.....	86	• Maintenance.....	186

Prompt: The content in this part is the most fundamental to ensure safe and comfortable driving by you. Please ask the sales consultant who delivers the vehicle to you to explain this part clearly to get the required knowledge and skills.



## Keys, Doors and Windows

Keys .....	6
Key-in Reminder* .....	7
Remote Control .....	7
Vehicle Locating.....	7
Remote Window Lowering .....	7
Remote Opening/Closing of Panoramic Sunroof* ....	7
Activation of Door Lock and Anti-theft Mode .....	7
Door Unlock and Release of Anti-theft Mode .....	8
Lock Function Alarm .....	8
Door Lock .....	9
External Door Locking and Unlocking .....	9
Child Safety Lock .....	11
Central Door Lock System .....	12
Door Lock Thermal Protection .....	12
Doors.....	12
Liftgate .....	12
Passive Entry Passive Start (PEPS) System* .....	13
Passive Entry .....	13
Passive Locking .....	13
Passive Unlocking/Locking of Liftgate.....	14
Engine Hood.....	14
Opening Engine Hood.....	14
Closing Engine Hood .....	15
Outside Rearview Mirror.....	15
Adjusting Outside Rearview Mirror.....	15
Electrically Folding Outside Rearview Mirror* .....	16
Automatically Folding Outside Rearview Mirror* ....	16
Folding .....	16
Defrosting of Outside Rearview Mirror* .....	16
Inside Rearview Mirror.....	17
Windows.....	17
Power Window .....	17
Sunshade .....	18
Auxiliary Handrail .....	19
Sunroof* .....	19
Power Sunroof*.....	19
Panoramic Sunroof* .....	20

### Keys

Type I



Type II



Type III



Each new vehicle is provided with two keys. Please reserve one key for spare.

For the sake of safety, please keep the key number plate in a safe place to prevent from illegal key making. Different models may be provided with different keys. Please refer to real vehicles.

#### Caution

**Do not leave the key in the vehicle. Take the key with you when you leave the vehicle.**

#### Note

**If the key is lost, please contact with the Aftersales Service Center.**

Detachable Type

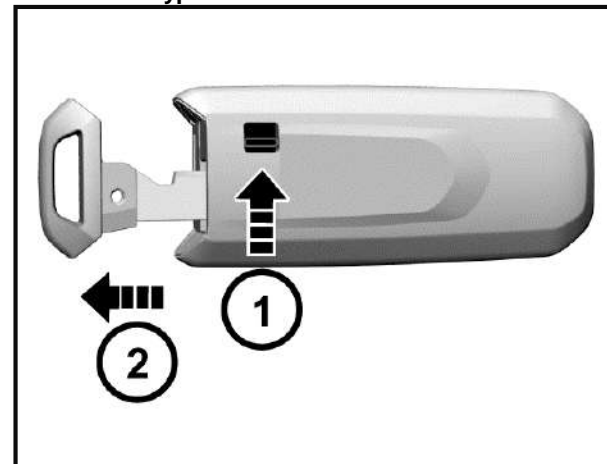

As shown in the figure above, turn the release switch ① on the key first, and then pull out the mechanical key ②. Plug back the mechanical key after use.

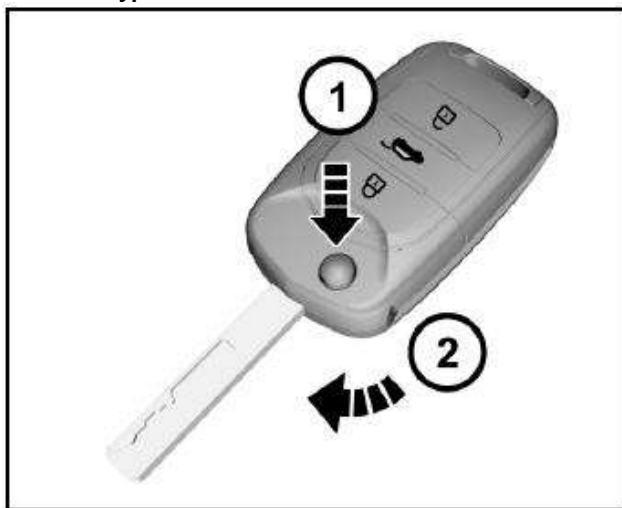
**Foldable Type**

As shown in the figure, press the release button, and the mechanical key will pop up automatically. Fold the mechanical key after use.

**Key-in Reminder\***

If the driver's door is opened when the ignition key is at LOCK position and is not pulled out, the instrument will ring for prompt. The function reminds you to take the key with you when you leave the vehicle.

**Remote Control**

The effective distance of remote control is about 15 m without shielding. When the ignition key is plugged in the switch or the ENGINE START STOP Switch is at ACC or ON position, the remote control does not function.

: remote lock button. Press the button once to lock all doors after all doors are closed; the hazard warning lamp will flash twice, and the vehicle is at anti-theft state.

: remote unlock button. Press the button once to unlock all doors; the hazard warning lamp will flash once, and the anti-theft state is released.

: liftgate unlock button. Press and hold for about 2s; open the liftgate, and the hazard warning lamp will flash once.

**Note**

The functioning range of the remote control may be different due to environmental reasons. Radio interference signals and barriers will affect the remote control functions.

**Vehicle Locating**

Press the remote unlock button quickly for two times to activate the vehicle locating function, and the hazard warning lamp will flash for 20 times.

**Remote Window Lowering**

Press and hold the unlock button for about 2s to lower all windows automatically and in turn.

**Remote Opening/Closing of Panoramic Sunroof\***

If the vehicle is configured with a panoramic sunroof, press the unlock button/lock button of the remote control for about 2s, the sun blind and sunroof will be opened/closed automatically.

**Activation of Door Lock and Anti-theft Mode**

1. Close all the windows.
2. Turn the ignition key to LOCK position and pull out the key (if mechanical ignition key is configured).
3. All passengers leave the vehicle.
4. Close all doors and the engine hood.

5. Press and release the remote lock button. All doors are locked. The hazard warning lamp will flash twice, and the immobilizer is activated.

As for a vehicle configured with ENGINE START STOP function, only when the ignition switch is at LOCK position can the transmitter activates the immobilizer system.

#### Note

**The anti-theft mode must be activated with the transmitter.**

- Warning sound

Under the anti-theft state, when the unlock button on the transmitter is not pressed and any of the doors or liftgate is forced opened in an abnormal way (including use of a key), the system will make the hazard warning lamp flash and emit warning sound.

- To stop warning sound

Press and hold the lock, unlock or liftgate button on the transmitter for about 2s or turn the key to ON position to top the warning sound; if not, the warning sound will be ended automatically after 30s, and the anti-theft mode is activated again. If the system fails to do so, it is recommended to have the system checked by the Aftersales Service Center.

#### Door Unlock and Release of Anti-theft Mode

1. Press the unlock button on the remote control once.
  - All doors are unlocked.
  - The hazard warning lamp flashes once.
  - The anti-theft state is released.

2. Press and hold the liftgate open button for 2s.

- The liftgate is opened.
- The hazard warning lamp flashes once.
- The anti-theft state is released.

#### Lock Function Alarm

The horn will buzz thrice and the hazard warning lamp will flash thrice to indicate that the doors are not locked successfully if the remote lock button is pressed or passive locking is conducted when the door lock conditions are not met. These situations include:

1. There is a door not closed (including liftgate);
2. The door lock is under thermal protection;
3. The ignition switch is not at the LOCK position;
4. The passive entry system (if configured) detects a legal key in the vehicle.

#### Caution

**Never leave a child or pet unattended in the vehicle. Otherwise, it may cause injuries or death due to high temperature in the vehicle.**

#### Automatic Locking of Door

When all doors are closed and the vehicle speed exceeds 10 km/h, all doors will be locked automatically.

#### Automatic Re-locking

With the key not in the ignition switch, the vehicle will activate re-locking if the alarm is disarmed but any of the doors and liftgate is not opened within 30s after the vehicle is under the armed state successfully.

#### Ignition OFF Unlocking

When the doors are locked, they will be unlocked automatically if the ignition switch is turned from ON position to ACC or LOCK position.

#### Remote Control

Each remote control has its own electronic code to prevent the doors being opened with other remote controls.

If the remote control is lost or stolen, please contact the Aftersales Service Center to buy a new one as soon as possible. If you need to replace one or more remote controls, please bring with the existing remote control(s) when you go to the Aftersales Service Center. When the Aftersales Service Center matches the remote control for replacement with the vehicle, the existing remote control shall also be matched with the new code. After the new remote control is coded electronically, the lost remote control will not unlock your vehicle. For Type I key, 3 transmitters can be configured at most each time; for Type II and III keys, 4 transmitters can be configured at most each time.



### Signal Transmission Autostop Function of Remote Control

The remote control has the signal transmission autostop function which can prevent unnecessary battery loss caused by misoperation and other reasons.

Long press any button on the remote control for over 10s, the remote control will stop transmitting signals automatically.

If the button is released, the signal transmission autostop function is deactivated.

### Fault

If the remote control cannot function normally, it may be caused by the following reasons:

- Out of remote control working range;
- Excessively low remote control battery;
- Interference by external environment and other high-power radio signals (such as base station and launch tower);
- Signal blocking by other barriers.

### Battery Replacement

Inside the key remote control, there is a lithium battery whose service life is 2 years generally. When the remote control distance is shortened gradually (i.e. must get closer to the vehicle), it indicates a low battery. The key battery cannot be charged. After the battery runs out, please go to the Aftersales Service Center to have the battery changed. Battery model: CR2032.

### Note

To ensure normal functioning of the remote control, please follow the following rules:

- Avoid dropping the remote control.
- Please do not place a heavy object on the remote control.
- Make sure the remote control is away from water or direct sunlight. If the remote control is soaked, please wipe with soft cloth.

## Door Lock

### External Door Locking and Unlocking

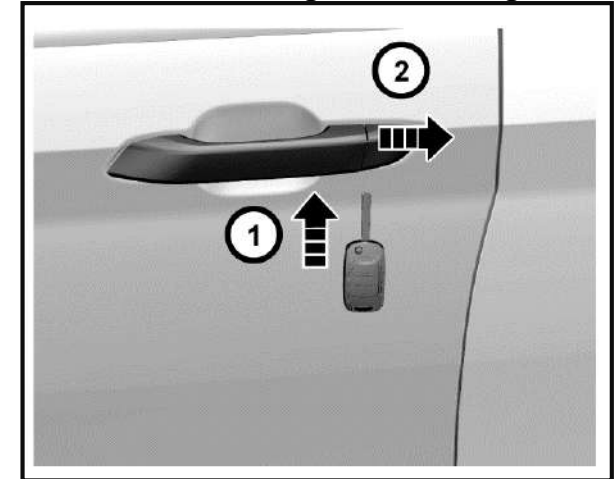

As shown in the figure above, the lockhole on the left front door external handle is hidden under the trim cover. The trim cover needs to be removed first if the key is used to open the door; for example, the remote control is lost or out of power.

Below the trim cover, there is a small hole. Plug the key in the hole and press inward; at the same time, prize up the trim cover outward to remove the cover.

For installation, press the trim cover inward to fasten it.

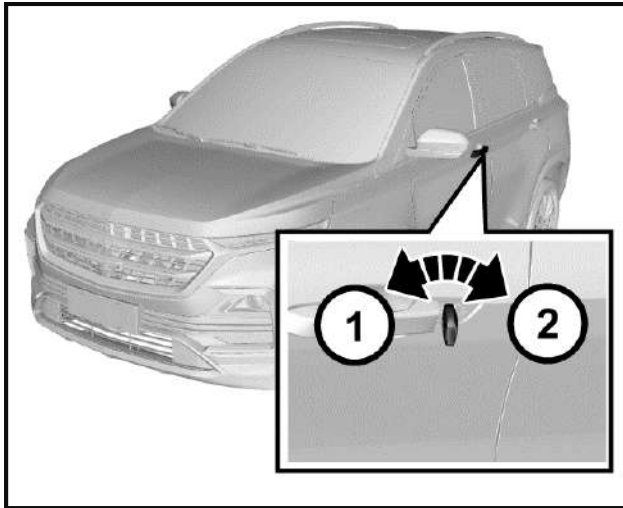

To lock a door outside of the vehicle with a key, plug the key and rotate it clockwise. Rotate the key counterclockwise to unlock the door.

**Caution**

**Do not leave a child or pet alone in the vehicle. Otherwise, severe casualty will be caused. The child may operate power windows or other control buttons or even drive the vehicle. Do not leave the child with a key in the vehicle. Such behaviors may cause severe casualties.**

**Internal Door Locking and Unlocking**

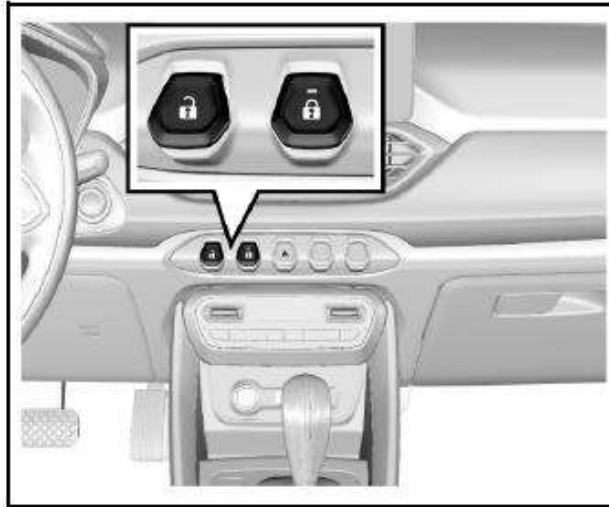

As shown in the figure, a central door lock switch is set on the middle of the instrument panel. To lock doors from inside, press the lock button on the central door lock switch.

To unlock doors from inside, press the unlock button on the central door lock switch.

If the lock button indicator is on, it means the doors are locked; if the indicator is off, it means the doors are unlocked.

**Note**

**When you leave the vehicle unattended, you must lock all doors and liftgate and take the key with you. If the doors and liftgate are unlocked, the vehicle may be stolen. Please park your vehicle in an attended place. It is recommended not to leave valuables in the vehicle to prevent losses due to unforeseen circumstances.**

**External/Internal Door Opening**

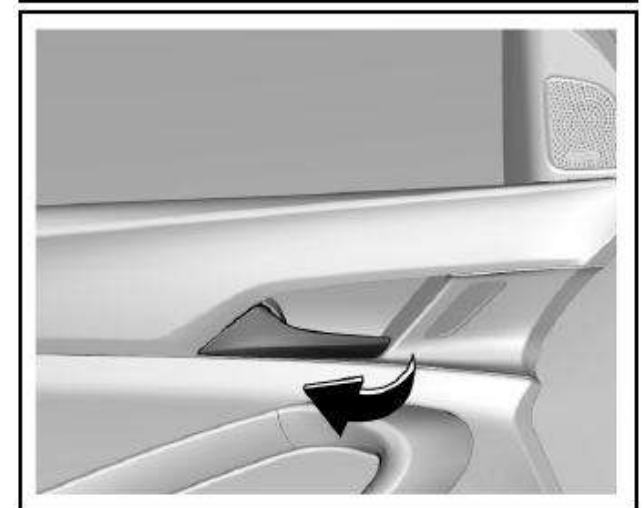

To open doors from inside or outside, unlock the doors first, and pull the external or internal door handles.

When the doors are locked, pulling the internal door handle twice can open the doors.

A child shall sit on the rear seat, and the door shall be locked with the child safety lock.

**Note**

**If there is noise while opening/closing doors or driving, apply lubricating grease on the door catches and hinges.**

**Door Locking Method in Case of Vehicle Outage**

In case of vehicle outage (for example, the battery is out of power or its positive and negative poles are disconnected), the central door lock system does not function, and you need to lock side doors manually one by one.

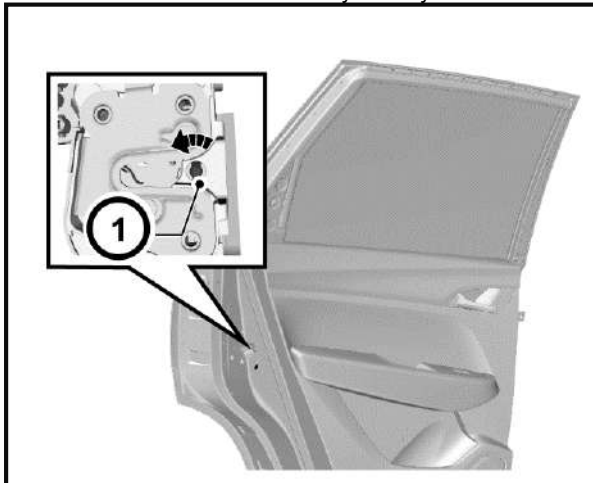

As shown in the figure above, open the right front door and two rear doors, and find the internal knobs of locks (not the knob of child safety lock).

Rotate the knobs outward with a key, and close the doors. At last, pull the external handles to ensure that the doors are locked. At this time, please pull the internal handle once first if you want to open the door.

For the left front door, please plug the key in the external door handle and rotate the key clockwise to lock the door. Please refer to the content in the Subsection "External Door Locking and Unlocking".

**Child Safety Lock**

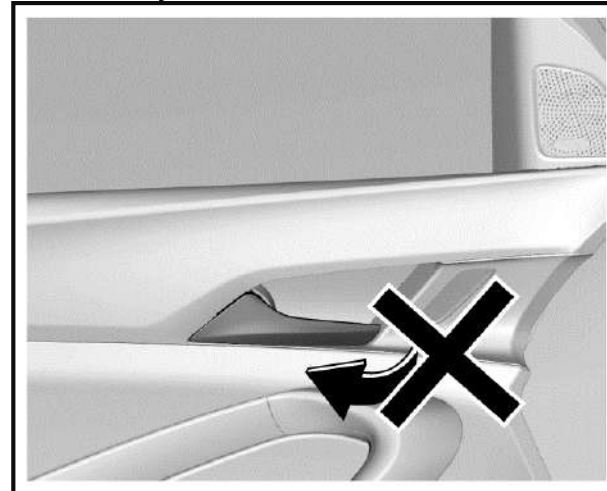

The rear doors are equipped with child safety locks. The function of the child safety lock is to prevent passengers (especially children) from pulling the door handle to open the rear door.

To activate the child safety lock:

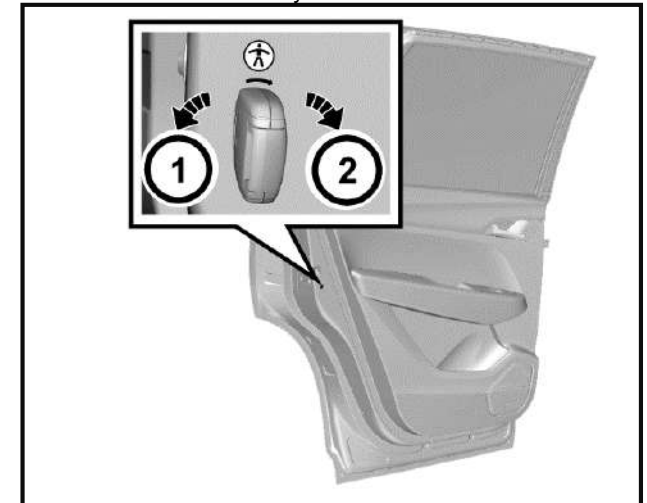

1. Open the rear door that you want to lock.
2. Find the child safety lock hole on the door edge and near the middle position.
3. Plug the key and rotate clockwise to the lock position. When the child safety lock is activated, you need to pull the external door handle to open the door. To deactivate the child safety lock, please plug the key and rotate counterclockwise to the unlock position.

**Note**

**The two rear doors are equipped with a child safety lock respectively. They function separately and must be activated manually and respectively.**

**Note**

**When the child safety lock is activated, do not attempt to pull the internal door handle to open the door. Otherwise, the door handle may be damaged.**

**Central Door Lock System**

The central door lock system enables you to lock and unlock all doors with the remote control or the central door lock switch from inside.

**Door Lock Thermal Protection**

If the doors are unlocked/locked for over 10 times within 8s, the locks will be prohibited for 10s to protect them.

**Doors**

**Liftgate**

**Liftgate Release Switch**

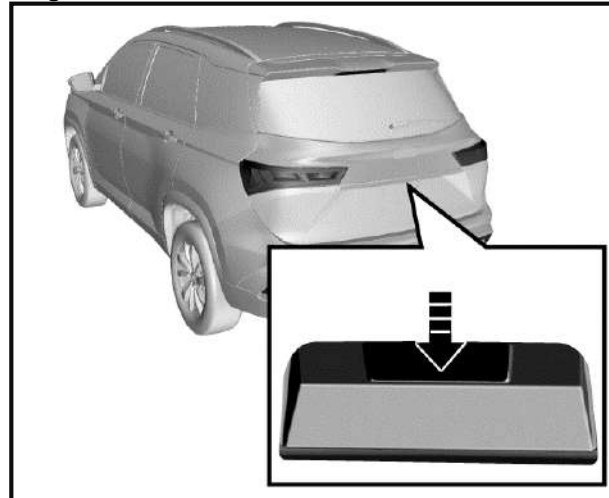

As shown in the figure, the liftgate release switch is above the liftgate release handle.

**Caution**

**Before driving, please make sure that the liftgate is closed and locked.**

**Liftgate Opening**

The liftgate can be opened in 3 ways:

1. Unlock doors first, and then press the liftgate release switch to open the liftgate.

2. Press the liftgate open button on the remote control key for about 2s to open the liftgate.
3. For vehicles equipped with passive entry passive start (PEPS) system, bring with the key and get close to the liftgate, and the liftgate can be opened by pressing the liftgate release switch.

Make sure that you and other persons are out of the liftgate moving range to prevent personal injuries when the liftgate is popped open.

To lock the liftgate, you need to close it and then lock it. Make sure that your or other persons' hands and bodies are out of the closing range of the liftgate.

**Liftgate Opening from Inside of Luggage Compartment**

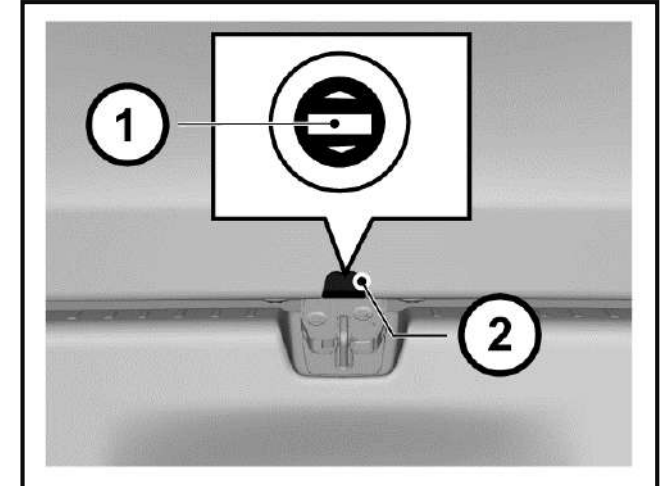

If other liftgate opening methods are invalid, the liftgate can be opened temporarily as per the following steps:

1. Fold the rear seat backrests, and get to the luggage compartment.
2. Prize up the trim cover outside the liftgate lock, and there is a slotted knob.
3. Plug a screwdriver or a key in the slot, and rotate the knob clockwise to open the liftgate.

### Passive Entry Passive Start (PEPS) System\*

High-configured models are equipped with PEPS system. You can lock or unlock the doors conveniently only by taking the remote control key with you and getting to the certain ranges of the front doors or liftgate. You can lock or unlock remotely without taking your key out from your pocket.

#### Passive Entry

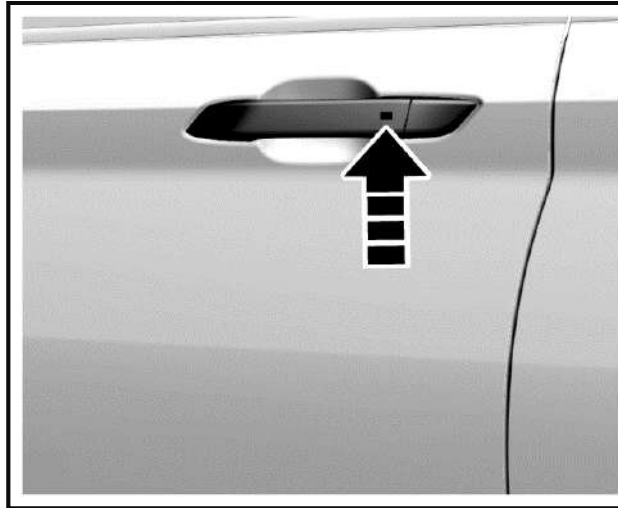

When the doors are locked and the ignition switch is at LOCK position, bring a legal key and get close to the front door handle (within 1.2 m); press the button on the handle, and the system will certify with the key. Once certified successfully, the system will unlock all doors. The hazard warning lamp flashes once.

#### Note

**If the remote control battery is low, the passive entry/locking function may fail, and you can use the mechanical key to lock/unlock doors. Please replace the remote control battery as soon as possible.**

#### Passive Locking

When all doors are closed and the ignition switch is at LOCK position, bring a legal key and get close to the front door handle (within 1.2 m); press the button on the handle, and the system will certify with the key. Once certified successfully, the system will lock all doors. The hazard warning lamp flashes twice.

The system will send warning prompt, the horn will buzz thrice and the hazard warning lamp will flash thrice to indicate that the doors are not locked when you press the button on the door handle in case of the following situations:

1. There is a door not closed;
2. The ignition switch is not at LOCK position;
3. There is a key in the vehicle.

Check one by one, and then lock again.

### Passive Unlocking/Locking of Liftgate Passive Unlocking

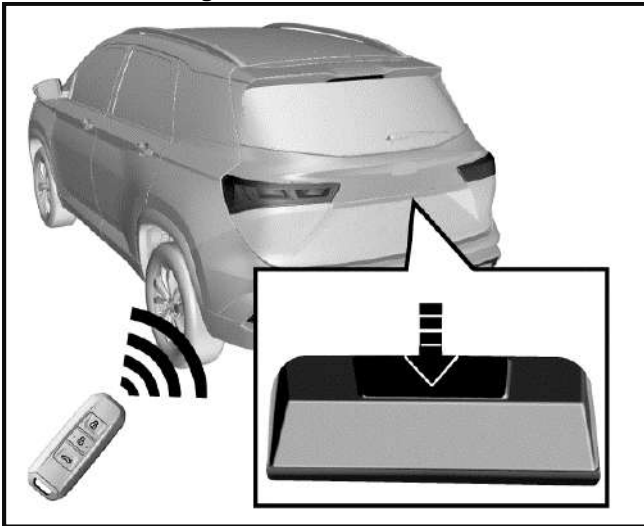

When the doors are locked and the ignition switch is at LOCK position, bring a legal key and get close to the liftgate (within 1.2 m); press the liftgate release switch, and the system will certify with the key. Once certified successfully, the system will unlock the liftgate, and the liftgate pops open.

If the doors are already unlocked, the liftgate can be opened by pressing the liftgate release switch directly (unnecessary to bring the key and get close to the liftgate).

### Passive Locking

If the doors are locked, when the liftgate is closed, the system will search automatically whether there is a legal key in the vehicle. If there is no legal key in the vehicle, the liftgate will be locked automatically. The hazard warning lamp flashes twice. If there is a key in the vehicle, the system will send warning prompt, the horn will buzz thrice and the hazard warning lamp will flash thrice; the four side doors will be unlocked automatically. Please take away the key in the vehicle, and lock the doors again.

If the doors are unlocked, the liftgate can only be locked after closing the liftgate and locking the doors. Please remember to lock the doors.

### Engine Hood Opening Engine Hood

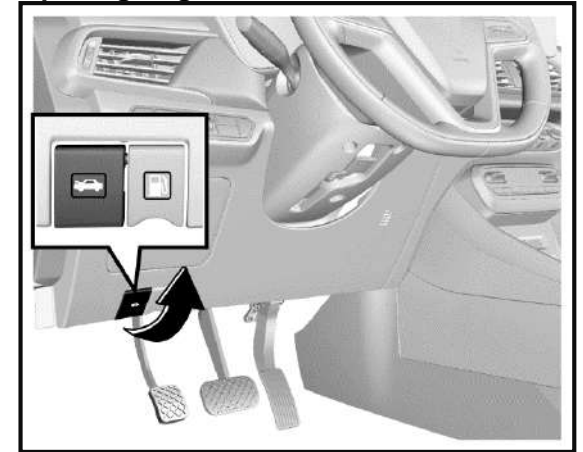

1. Pull the engine hood release handle on the left lower side of the instrument panel.

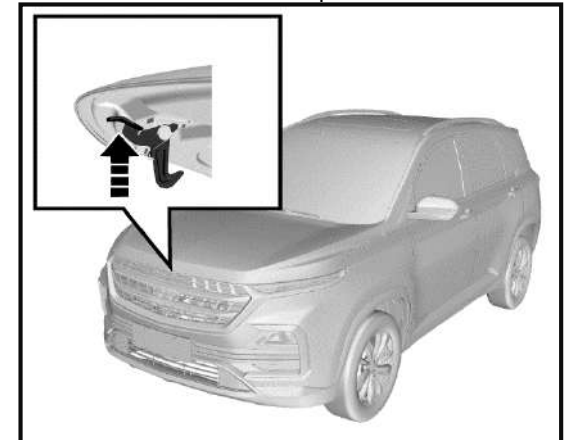

- After the engine hood is opened slightly, stretch out the hand to the lower side of the engine hood front edge. Pull the engine hood release handle upward as shown in the figure to open the engine hood completely.



- Separate the engine hood prop rod from the fixing clamp. Plug the free end of the prop rod in the slot.

### Closing Engine Hood

- Support the engine hood to prevent it from closing, and take the prop rod out from the slot. Then, fix the rod in the fixing clamp.
- Make sure that your or other persons' hands or other body parts are away from the engine compartment, engine hood and vehicle body edges.
- Slowly drop the engine hood, and release it when the engine hood front edge is about 30 cm vertically from the top crossmember of the water tank to let it fall freely.

- Always check and confirm that the engine hood is locked in place.

### Caution

- Pull the engine hood front edge before driving to make sure that the engine hood is locked.
  - Do not pull the engine hood release handle when the vehicle is moving.
  - Do not drive the vehicle when the engine hood is open. If the engine hood is open, the driver's sight will be blocked.
- Driving when the engine hood is open may cause a collision accident, damaging your vehicle or other properties or leading to casualties.

### Outside Rearview Mirror

Please check the visual field of all rearview mirrors before driving.

### Adjusting Outside Rearview Mirror

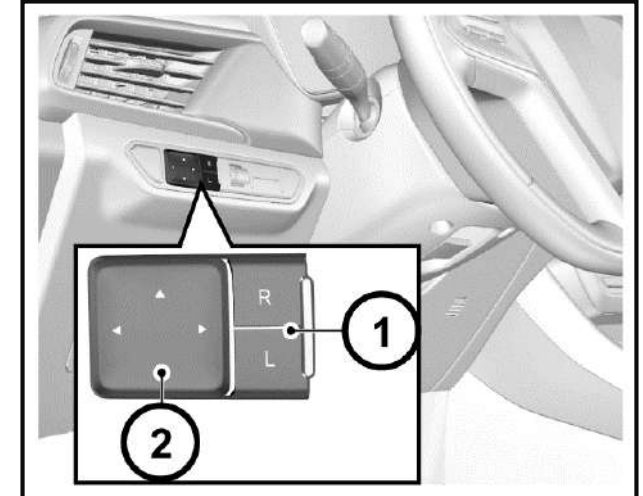

The power outside rearview mirror adjustment switch is on the left side of the instrument panel. Adjust the outside rearview mirror as per the following steps:

- Select the rearview mirror to be adjusted. Press the "L" or "R" on the selector switch to adjust the left or right outside rearview mirror.
- Press the buttons ( $\Delta$ ) around the setting pan to adjust the selected rearview mirror upward, downward, leftward and rightward.
- After adjustment, recover the selector switch to non-pressed state (both ends not pressed).

**Electrically Folding Outside Rearview Mirror\***

Press the electric folding button  to fold the outside rearview mirror automatically.

Press the button once again, and the mirror will be unfolded automatically.

**Automatically Folding Outside Rearview Mirror\***

The outside rearview mirror will be folded automatically when the doors are locked. It will be unfolded automatically when the doors are unlocked.

If the electric folding button is pressed, the outside rearview mirror will not be unfolded automatically when the doors are unlocked.

**Deactivating Automatic Folding Function of Outside Rearview Mirror\***

In frosty weather, the outside rearview mirror and its spindle may be frozen in folded state, and the mirror cannot be unfolded. That will affect your driving. Therefore, we suggest you deactivate the automatic folding function of the outside rearview mirror temporarily in icy winter to let the mirror maintained in unfolded state.

Method: Enter the audio setup interface, and set the “Rearview Mirror Folding” to “OFF” under the “General Setup” interface. Thus, the outside rearview mirror will not be folded automatically when the doors are locked.

**Notes to Electrical Folding of Frozen Outside Rearview Mirror**

If the outside rearview mirror and its spindle are frozen, please remove the freeze first, and use the electric folding/unfolding functions. For example, if the mirror is frozen after the vehicle is parked outdoors for a night in winter, please remove the freeze first, and use the remote control or the passive entry button to unlock doors. Then, the outside rearview mirror will be unfolded smoothly. If the freeze is not removed, the freeze will hinder the movement of the rearview mirror, damaging the mirror.

If the outside rearview mirror glass is frozen, please remove the freeze first, and then use the defrosting function for auxiliary heating and deicing. If the freeze is not removed, the freeze will hinder the movement of the rearview mirror while adjusting the mirror, causing damage to the mirror.

**Folding**

To ensure the pedestrian's safety, the outside rearview mirror can be folded forward or backward from its normal mounting position under sufficient impact force. It can be moved and reset manually.

**Defrosting of Outside Rearview Mirror\***

The outside rearview mirror of some models is configured with defrosting function. Press the rear defrost button on the A/C control panel for defrosting. Refer to the content of the rear defrost button in the Chapter “HVAC”.



## Inside Rearview Mirror

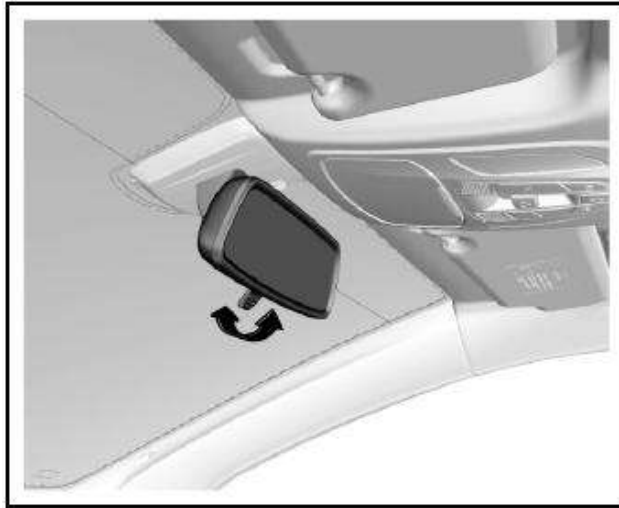

Adjust the rearview mirror to an appropriate angle manually. The rearview mirror of some models has anti-dazzling function which can reduce the dazzling effect from vehicles behind at night. Turn the switch at the rearview mirror bottom forward to activate the anti-dazzling mode. Please remember to turn the switch back at day time.

### Note

The anti-dazzling mode will reduce the vision clarity behind the vehicle. Please drive carefully.

## Windows

### Power Window

When the ignition switch is at ON position, you can control the power window with the power window switch on the door armrest panel. You can also use the combination switch on the driver's side to control other power windows.

The windows can also be controlled with the power window switches within 30s after the ignition switch is turned from ON position to ACC or LOCK position or the key is pulled out.

### Caution

Children may operate the power window and may get stuck by the window when they operate it. Do not leave a key or an unattended child in the vehicle. Misoperation of the power window may cause casualties.

## Power Window Switch

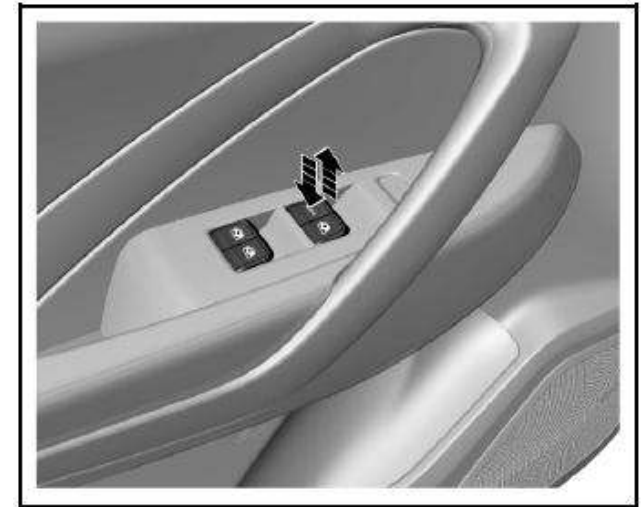

To raise the window, pull upward the switch. To lower the window, press down the switch. When the window reaches the desired position, release the switch.

### Caution

If an occupant stretch his/her body out of the vehicle, he/she may be hit by objects passing by. Do not stretch any body part out of the vehicle.

### One-button Lowering of Driver's Side Power Window

The driver's side power window has the one-button lowering function. Press the switch to the bottom and release, and the window will be lowered to the fully-open position automatically. To stop lowering the window, pull upward the button and release (short pull is ok).

**One-button Rising of Driver's Side Power Window\***

The driver's side power window of some models has the one-button raising function. To close the window, pull upward the switch to the top and release, and the window will be raised automatically to the fully-close position. To stop raising the window, press down the button and release (short press is ok).

**Anti-pinch Function of Driver's Side Power Window\***

The power window that has the one-button rising function also has the anti-pinch function to reduce pinching injuries. The power window will be lowered automatically for a distance in case of any obstruction in its one-button rising process.

**Remote Lowering of Power Window**

Press and hold the unlock button on the remote control key for about 2s to lower all window glass in turn.

**Initialization Learning of Driver's Side Power Window\***

The driver's side window may lose the on-button rising and lowering functions in some cases, such as battery connection after disconnection. In case of such outage, the window initialization learning shall be conducted first. First, pull upward the driver's side switch till the window glass is closed completely, and continue to pull upward the switch for at least 5s and release it. Now the initialization learning is completed. If the one-button raising or lowering function is still unavailable after initialization learning, it is recommended to drive to the Aftersales Service Center for check and repair.

**Power Window Lock Button**

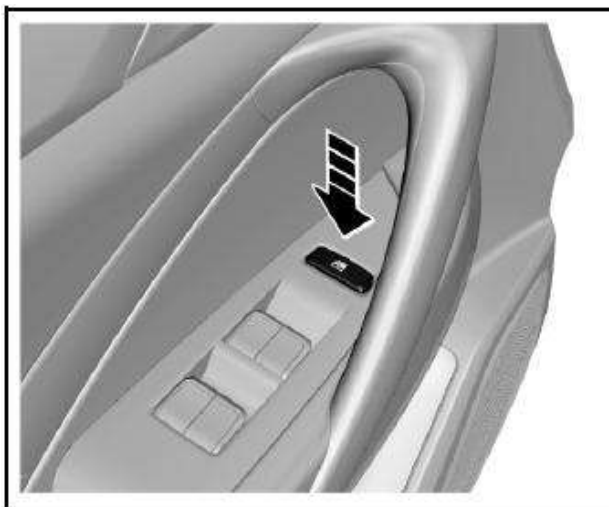

The power window lock button can lock the front passenger's side and rear power window switches. Press the button, and other power window switches are locked. The windows can only be operated with the driver's side window control panel.

Press the button once again, and the lock can be released.

**Caution**

**Children may operate the power window and may get stuck by the window when they operate it or may get out of the vehicle from the window, leading severe casualties. Please use the power window lock when there is a child in the vehicle.**

**Sunshade**

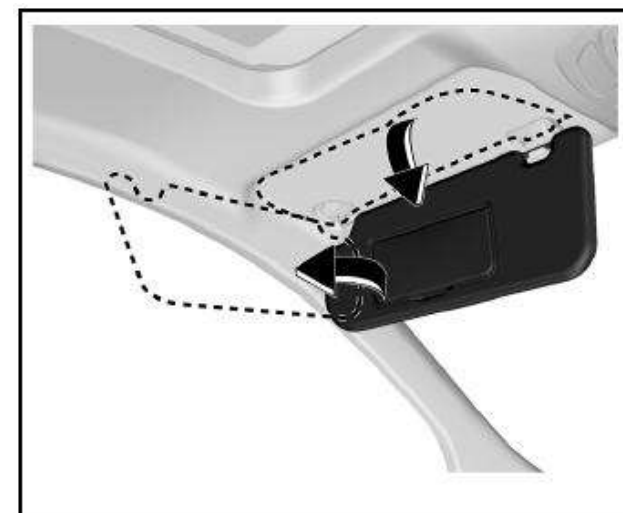

Your vehicle is configured with sunshade which can reduce dazzling effect on the driver and passengers.

The sunshade can move upward, downward and sideward. Depending on the configuration, the sunshade may be equipped with a bill fold and vanity mirror.

## Auxiliary Handrail

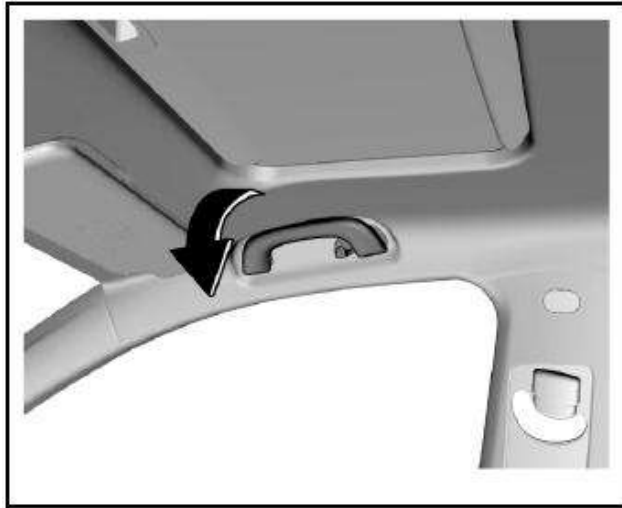

Above the front passenger's side door and rear doors, an auxiliary handrail is installed. The handrail of some models is equipped with a clothes hook.

The auxiliary handrail is convenient for passengers to get in and out of the vehicle. The passengers can also grab the handrail to help maintain the sitting position when the vehicle speed is fast.

While using the auxiliary handrail, hold it downward. When it is released, it will return automatically.

## Sunroof\*

When the ignition switch is at ON position, the power sunroof can be operated.

### Caution

Always observe the following notes:

- Do not stretch out the body or any object out of the sunroof.
- Please ensure that there is no object in and out of the sunroof before the sunroof is opened or closed.
- Do not place a heavy object on or around the sunroof.
- Make sure that there is no rubbish on the outer side of the sunroof.
- When the vehicle is left unattended, the sunroof must be closed.

All occupants must buckle seat belts in all cases no matter whether the sunroof is opened or closed.

If the notes above are not observed, severe injuries or vehicle damage will be caused.

## Power Sunroof\* Sunroof Sliding

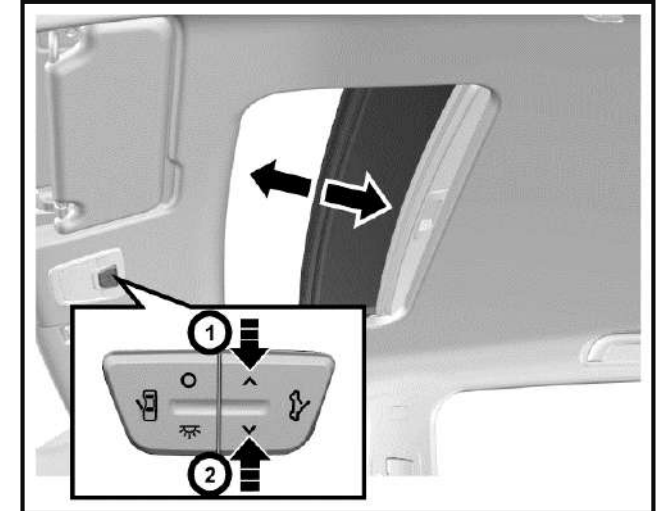

- To slide open the sunroof, press the rear end of the switch once quickly and release (operate within 0.3s). After the sunroof reaches the desired position, press the front end or rear end of the switch again. Or, press and hold the rear end, and release the switch after the sunroof reaches the desired position.
- To slide close the sunroof, press and hold the front end of the switch, and release the switch when the sunroof reaches the desired position but is not completely closed. To completely close the sunroof, press and hold the front end of the switch, and release the switch when the sunroof stops moving, or press the front end of the switch once quickly and then release (operate within 0.3s).

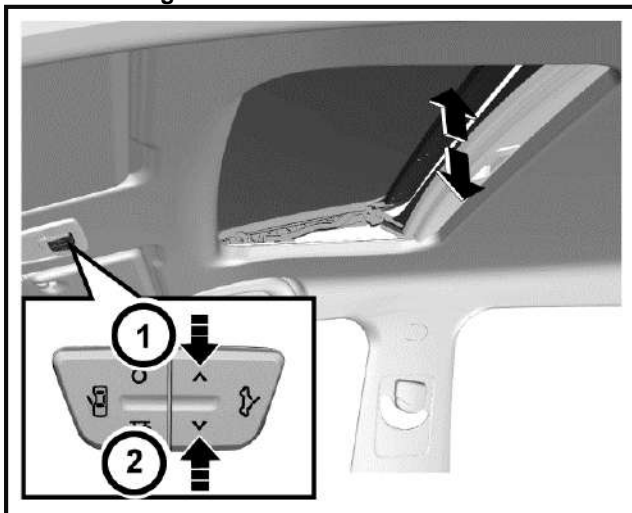
**Sunroof Tilting**

- To tilt open the sunroof, press the front end of the switch when the sunroof is completely closed, and release the switch when the sunroof reaches the desired position. To completely tilt the sunroof, press and hold the front end of the switch, and release the switch when the sunroof stops moving, or press the front end of the switch once quickly (operate within 0.3s).
- To completely close the tilted sunroof, press and hold the rear end of the switch, and release the switch when the sunroof reaches the desired position but is not completely closed. To completely close the sunroof, release the switch when the sunroof stops moving, or press the rear end of the switch once quickly and then release (operate within 0.3s).

**One-button Opening or Closing of Sunroof**

While operating the sunroof switch, you can press the front or rear end of the switch once quickly (operate within 0.3s), and the sunroof will be closed or opened automatically.

**Sunroof Anti-pinch Function**

The sunroof will retract to prevent pinching persons when it contacts a certain rigid obstacle (such as the arm and head) in its one-button closing process.

**Sunroof Initialization Learning**

The sunroof may lose its one-button opening or closing function in some cases, such as replacement of sunroof glass or motor. In case of such outage, the sunroof initialization learning shall be conducted first. When the sunroof is completely closed, press and hold the front end of the switch; release the switch temporarily and then continue to press and hold the switch for at least 5s when the sunroof glass tilts completely; finally, release the switch. At this time, the sunroof glass will shake slightly, indicating that the initialization learning is completed. If the one-button opening or closing function is still unavailable after initialization learning, it is recommended to drive to the Aftersales Service Center for check and repair.

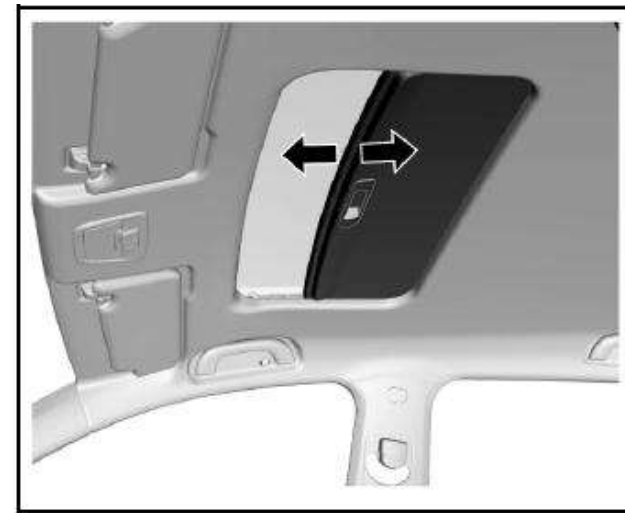
**Sun Visor**

The sunroof visor can only be opened and closed manually.

**Panoramic Sunroof\***

The panoramic sunroof is composed of two parts—the front part is tiltable and slidable and the rear part is fixed.

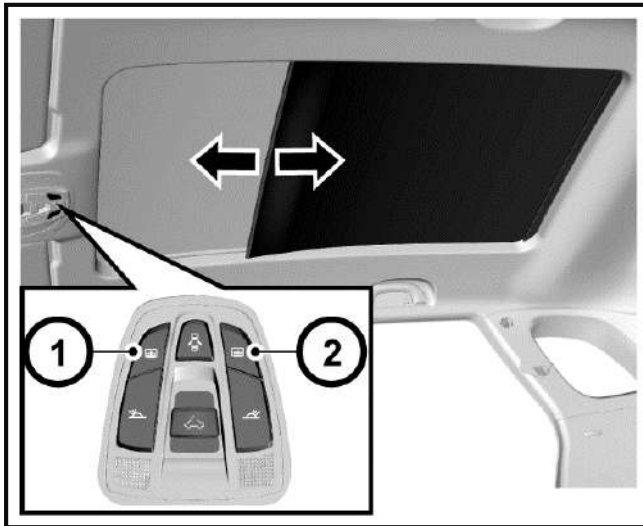
**Sun Blind**

Press the open or close button of the sun blind to slide open or close the sun blind. When it reaches the desired position, release the button. Short press the button, and the sun blind can be opened or closed automatically.

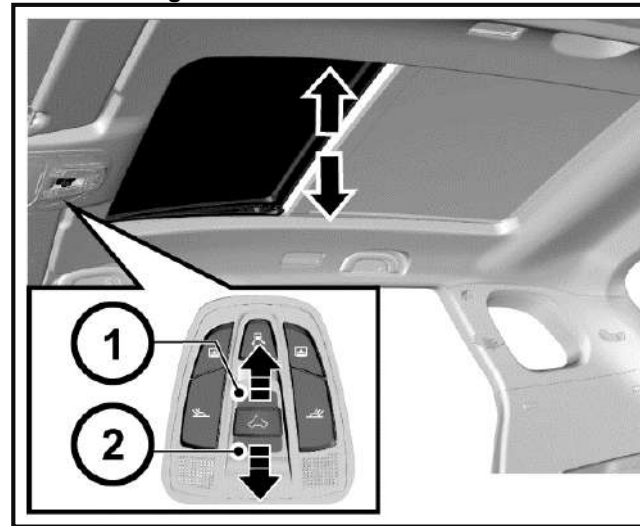
**Sunroof Tilting**

The front part of the sunroof can be tilted. To tilt open the sunroof, push the sunroof switch backward when the sunroof is completely closed, and release the switch when the sunroof reaches the desired position. To completely tilt open the sunroof, push and hold the switch, and then release the switch when the sunroof stops moving. You can also push the sunroof switch (short press) backward once quickly, and the sunroof will be tilted open automatically. To close the tilted sunroof, push the sunroof switch forward, and release the switch when the sunroof reaches the desired position. To completely close the sunroof, release the switch when the sunroof stops moving. You can also push the sunroof switch (short press) forward once quickly, and the sunroof will be closed automatically.

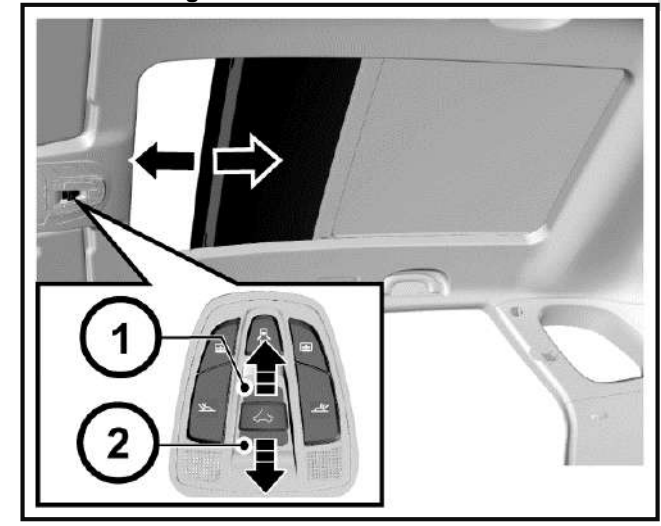
**Sunroof Sliding**

The sunroof can be slid open backward after it is completely tilted open.

To slide open the sunroof, push the sunroof switch backward, and release the switch when the sunroof reaches the desired position. You can also push the sunroof switch backward once quickly (short press), and the sunroof will be slid open automatically.

To slide close the sunroof, push the sunroof switch forward, and release the switch when the sunroof reaches the desired position. To completely close the sunroof, release the switch when the sunroof stops moving. You can also push the sunroof switch forward once quickly (short press), and the sunroof will be slid close automatically.

### **One-button Opening or Closing**

Push the switch once quickly (short press) while operating the sunroof switch, and the sunroof can be closed or opened automatically.

In the process of opening, push the switch backward once quickly (short press) to tilt open the sunroof; push again to slide open the sunroof.

In the process of closing, push the switch forward once quickly (short press), and the sunroof will be completely closed automatically.

To stop in the process of automatic opening or closing, push the switch once.

### **Anti-pinch Function**

The sunroof and the sun blind will retract to reduce pinching risks when they contact a certain rigid obstacle (such as the arm and head) in their one-button closing or remote closing process.

### **Remote Sunroof Opening and Closing**

Press the unlock button/lock button of the remote control for about 2s, the sun blind and sunroof will completely be opened/closed automatically.

### **Sunroof Initialization Learning**

The sunroof or the sun blind may lose its one-button opening or closing function in some cases, such as replacement of sunroof glass or motor. In such cases, the sunroof or sun blind initialization learning is necessary.

Method: Move the sunroof or sun blind to the completely close position; push the sunroof switch forward for about 10s or press the close button of the sun blind for about 10s; when the operation sound of the sunroof mechanism is heard, the sunroof or sun blind initialization learning is completed. If the one-button opening or closing function still cannot be recovered after initialization learning, please drive to the Aftersales Service Center for check and repair.

### **Shutdown Delay Function**

Within 30s upon vehicle shutdown, the sunroof and sun blind can be closed with buttons but cannot be opened.

### **Linkage Function**

The linkage function of the sunroof and sun blind enables passengers in the vehicle to see the sunroof glass position when the sunroof is opened and to avoid forgetting to close the sunroof when the passengers leave the vehicle.

When the sunroof sun blind is completed closed, the sun blind will move the half-open position along with the sunroof if the sunroof switch is pushed backward and held. If the button is released in the long pressing process, the glass will stop moving immediately, and the sun blind will move to the half-open position and then stop.

When the sunroof glass is completely opened, if the sun blind close button is long pressed, the glass will be closed along with the sun blind. If the button is released in long pressing process, the glass will stop moving, and the sun blind will stop moving (not reaching the half-open position) or return to the half-open position (exceeding the half-open position).

## Seats and Protective Devices

Headrest.....	24
Position .....	24
Height Adjustment.....	24
Front Seat.....	24
Seat Position and Backrest Normal Condition .....	24
Seat Position Adjustment.....	25
Seat Backrest Adjustment.....	25
Driver's Seat Height Adjustment .....	26
Middle Seat .....	27
Middle Seat (Only for 7-seat Model) .....	27
Rear Seat .....	28
Rear Seat (5-seat Model).....	28
Rear Seat (7-seat Model).....	28
Armrest .....	29
Seat Belt.....	29
Wearing .....	30
Height Adjustment* .....	31
Unbuckle.....	31
Middle Row/Rear Row Seat Belt.....	31
Seat Belt Use during Pregnancy .....	32
Child Seat.....	33
Child Restraint System Type.....	33
ISOFIX .....	34
Air Bag System.....	35

### Headrest Position



The middle position of the headrest should be on the same horizontal line as the occupant's eyes. For tall persons, if the above point cannot be met, the headrest shall be adjusted to the highest position; for short persons, the headrest shall be adjusted to the lowest position.

#### Warnings

**Before driving, make sure that the headrest is adjusted properly. Removal or improper adjustment of the headrest will cause severe injuries to the head and neck in collision accidents.**

### Height Adjustment

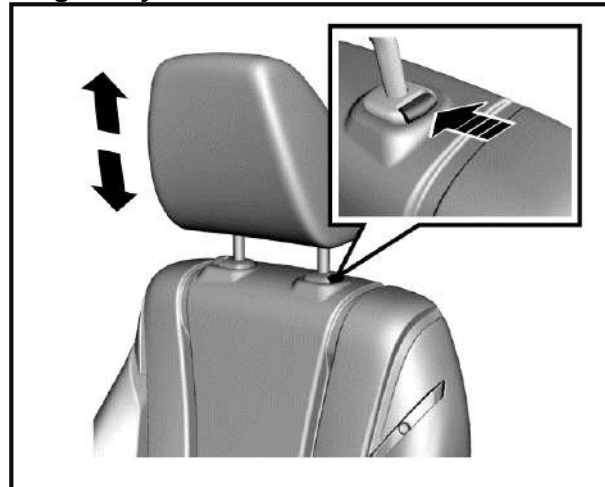

To adjust the headrest upward, pull the headrest upward to a proper position and fix it. To remove the headrest, press and hold the release switch.

To adjust the headrest downward, press and hold the release switch and push the headrest downward to a proper position; then, release the release switch for fixation. Pay attention not to press the headrest forcibly to avoid injuring the finger pressing the release switch.

### Front Seat Seat Position and Backrest Normal Condition



- When you sit on the seat, make your hip as close to the backrest as possible. Adjust the distance between the seat and the pedal to make your leg slightly bend when you press the pedal. The passenger's seat shall slide as backward as possible.
- When you sit on the seat, make your shoulders lean on the backrest as backward as possible. Set the backrest inclination angle to make your arm conveniently to reach the steering wheel while slightly bending the arm. Keep the shoulders leaning against the backrest while turning the steering wheel. The backrest shall not incline excessively backward. We suggest that the inclination angle of all backrests shall not be more than 25 degree.
- The seat height shall be so set that the occupant can see all directions and the positions of all display instruments. The head must be at least one hand away from the roof lining.



The thighs are right on the seat without constriction.

**Warnings**

**Correctly adjust the seat before driving the vehicle. Never adjust the seat when the vehicle is running because the seat may not move as controlled.**

**Seat Position Adjustment  
Manual Adjustment Type\***



Pull upward the adjustment lever on the front lower part of the seat to adjust the seat forward or backward, and release the lever after the seat is adjusted to a proper position. Try to slide the seat forward and backward to ensure that the seat is locked at a proper position.

**Electric Adjustment Type\***

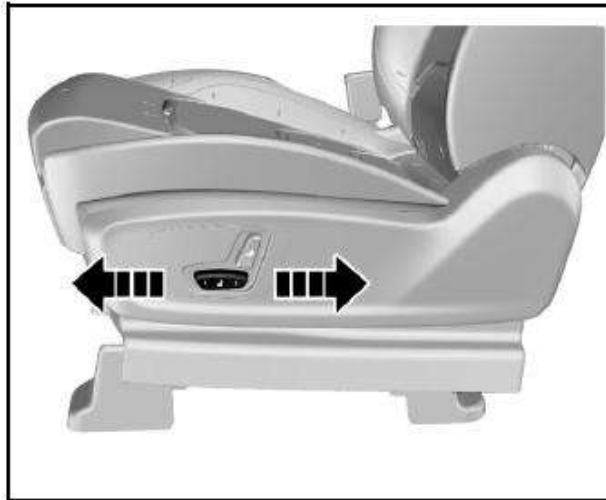

As shown in the figure, the electric adjustment switch is on the outer side of the seat. Push the switch forward or backward, and the seat will move forward or backward accordingly. Release the switch when it reaches a proper position.

**Note**

**If the seat does not move when the switch is pushed, the seat may be already at the front or rear limit position, or the vehicle battery is out of power. Please check for confirmation. Never turn the switch forcibly to avoid damaging it.**

**Seat Backrest Adjustment  
Manual Adjustment Type\***



Pull up the handle near the seat cushion; adjust the backrest inclination angle to a proper position; then, release the handle. Please do not lean on the seat backrest while adjusting. After adjusting the seat backrest, try to shake the backrest to ensure that the backrest is locked.

**Electric Adjustment Type\***



As shown in the figure, turn the adjustment switch forward and backward, and the backrest will be folded forward or unfolded backward. Release the switch when it is adjusted to a proper position.

**Note**

If the backrest does not move when the switch is turned, the backrest may be already at its limit position, or the vehicle battery is out of power. Please check for confirmation. Never turn the switch forcibly to avoid damaging it.

**Warnings**

The backrest plays an important protection role when the vehicle is running. Unlocked backrest may cause severe personal injuries in case of sudden braking or a collision. Any time after adjusting the seat backrest, shake the backrest to check whether it is locked even though no passenger occupies the seat.

**Driver's Seat Height Adjustment  
Manual Adjustment Type\***



Turn the handle on the outer side of the seat upward and downward until the seat is adjusted to the desired height. While adjusting the seat height, the seat must be loaded. Therefore, please sit on the seat before adjustment; otherwise the adjustment device may be damaged.

**Electric Adjustment Type\***

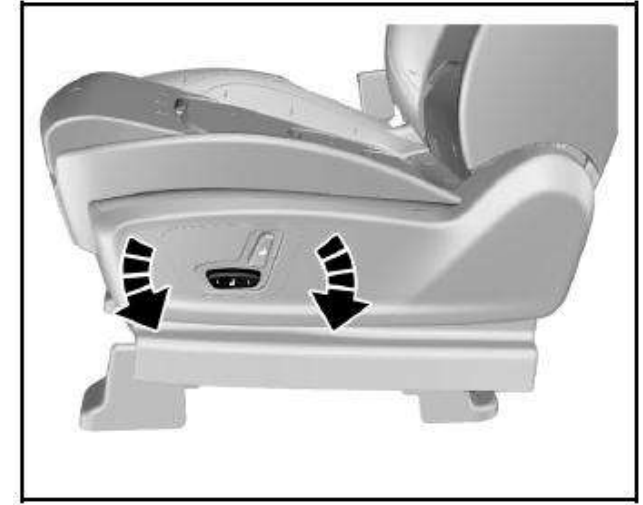

As shown in the figure, rotate the height adjustment switch on the outer side of the seat cushion, and then release the switch after the seat is adjusted to proper height. The electrically-adjustable front passenger's seat cannot be adjusted upward or downward.

**Middle Seat**

**Middle Seat (Only for 7-seat Model)**

**Overturning Right Seat of Middle Row**

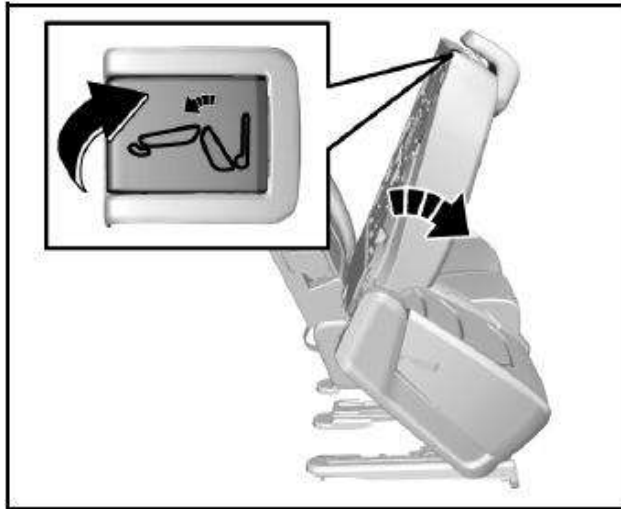

For 7-seat models, if a person wants to sit on the rear seat, please get in the vehicle from the right rear door. Overturn the right seat of middle row forward first to make room for getting to the rear seat.

The method of overturning the right seat of middle row:

As shown in the figure, pull up the release handle near the seat headrest, and overturn and move the seat forward. To recover, push the seat backward to fix it. Try to shake the seat to check whether it is fixed.

The left seat of middle row cannot be overturned. Therefore, if a person wants to sit on the rear row, please do not get in the vehicle from the left rear door but the right rear door.

**Seat Position Adjustment**



To adjust the seat forward or backward, pull upward the adjustment lever on the front lower part of the seat to adjust the seat forward or backward, and release the lever after the seat is adjusted to a proper position.

Try to shake the seat to check whether it is fixed.

**Seat Backrest Adjustment and Folding**



The seat backrest inclination angle is adjustable within a certain range.

First hold the backrest with hands because the backrest will be folded quickly and may cause impact or injuries after the backrest release belt is pulled up. Then, pull the backrest release drawstring on the seat side backward, and release the drawstring after a proper angle is obtained.

To fold the seat backrest, pull up the drawstring and fold the backrest forward. Overturning the seat cushion first and then folding the backrest can fold flat the backrest to the greatest extent.

To recover, pull up the drawstring and unfold the backrest to a proper angle. Finally, try to shake the backrest to check whether it is fixed.

**Note**

Hold the backrest first and do not make the head or other body parts within the backrest folding range before pulling the backrest drawstring and folding the backrest. Otherwise, the backrest will be folded quickly and may cause impact or injuries.

**Seat Cushion Overturn**

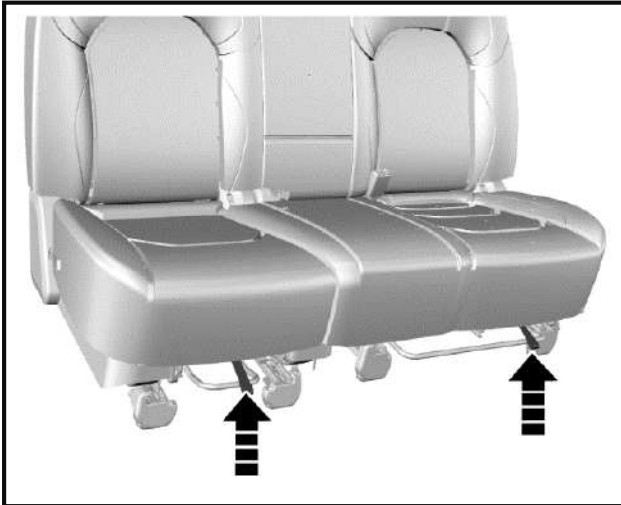

At the front lower position of the seat cushion, there are two cushion unlock drawstrings; the seat cushion can be unlocked by pulling the corresponding drawstrings.



As shown in the figure, after the cushion is unlocked, pull out the cushion forward and lift up the rear part of the cushion to overturn it. The two cushions can all be overturned.

To recover, install the cushion back in opposite order, and press down the cushion with force. Try to shake the seat cushion to make sure that it is locked.

**Rear Seat**

**Rear Seat (5-seat Model)**

Refer to the adjustment method for the middle seat of 7-seat models for that of the rear seat of 5-seat models. The difference is that the rear seat cannot be adjusted forward or backward.

**Rear Seat (7-seat Model)**

**Foldable Seat Backrest**

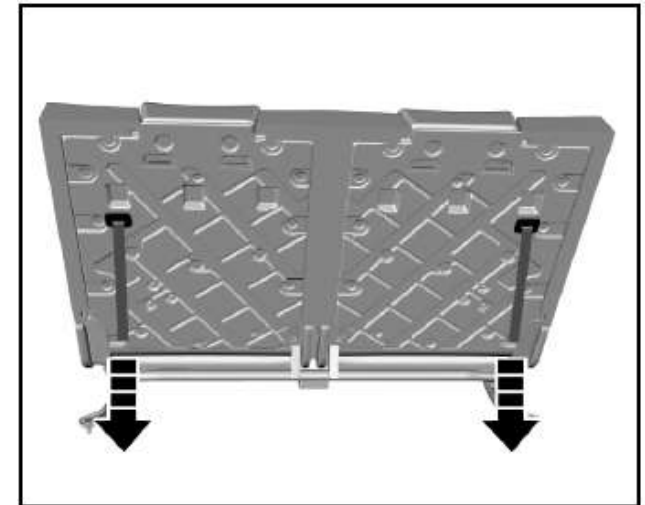

The rear seat backrest is foldable. Pull the drawstring behind the backrest to unlock the backrest, and then fold the backrest forward.

To recover, pull the drawstring to unfold the backrest.

Try to shake the seat backrest to check whether it is fixed.

**Armrest**



As shown in the figure, the second row seat is configured with an armrest. Deploy the armrest for use. There is a cup holder on the armrest. After use, please put back the armrest.

**Seat Position and Backrest Angle for Measurement of Seat Cushion Thickness**

For measurement of the seat cushion thickness, the seat can be in any position.

The seat backrest shall incline backward for a certain angle from the vertical position. The angle is 23°, 25° and 20° respectively for the 1st, 2nd and 3rd row.

**Seat Layout Diagram**

**5-seat**

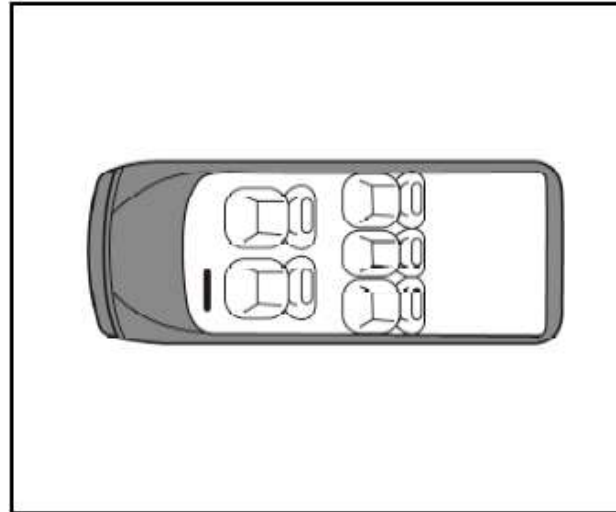

**7-seat**

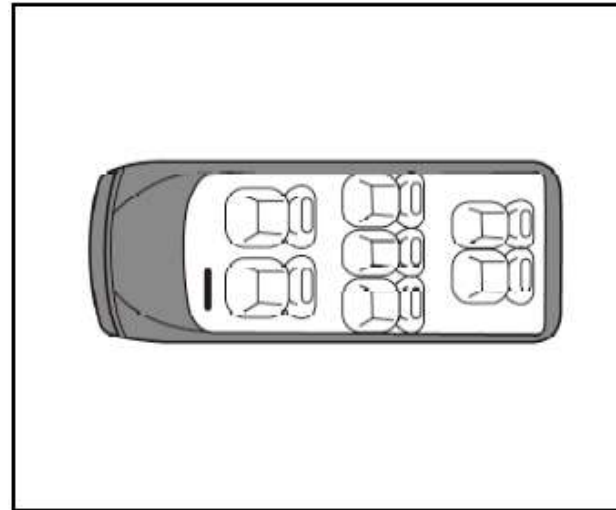

**Seat Belt**



The seat belt is designed only for one passenger each time. It is not applicable to a passenger under 12 years old or under 150 cm high. Check all parts of the seat belt system for damage and abnormal function regularly. Please replace the damaged parts and components. It is strongly recommended to have the seat belt or deployed seat belt tensioner at the Aftersales Service Center replaced after an accident.

**Seat Belt Force Limiter\***

It is configured on the seat belts for the driver's seat and the left seat of second row. For some models, the front passenger's seat belt is also configured with a force limiter. The force limiter can reduce the stress applied on the body through the seat belt damping release in case of a collision accident.

**Seat Belt Pretensioner\***

Depending on different models, it is configured on the seat belt for the driver's seat, front passenger's seat of the left seat of the second row. In case of a severe head-on or rear-end collision, the front part of the seat belt will be tensioned. The deployed seat belt pretensioner must be replaced by the Aftersales Service Center. The seat belt pretensioner can only be deployed once.

**Note**

**Make sure that the seat belt is not damaged or clamped by a sharp object. Prevent dust from getting in the seat belt recoiler.**

**Warnings**

**Improper operation (for example removal or installation of seat belt or seat belt anchor buckle) will trigger the seat belt tensioner, leading to injury risks.**

**Warnings**

**Buckle the seat belt each time before driving the vehicle. In case of an accident, a passenger who does not buckle the seat belt may be at risk.**

**Note**

**It is not allowed to add any accessory or other object that may interfere with the operation of the seat belt. Do not change any seat belt component.**

**Warnings**

**The seat belt shall not be buckled against a hard or fragile object in your pocket. Otherwise, the hard object will hurt you and the fragile object may be damaged in case of emergencies.**

**Note**

**Pay attention to prevent foreign matters from getting in the seat belt buckle (such as sunflower seed shell and button); otherwise the seat belt buckle will fail.**

**Wearing**



1. Pull out the seat belt from the recoiler, and fasten it across the body without twisting.

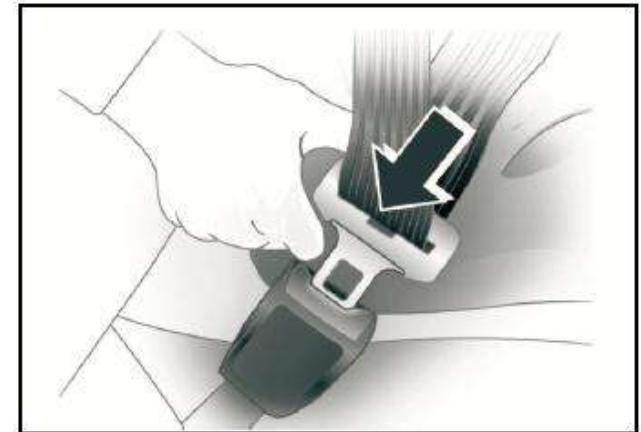

2. Put the latch plate in the buckle for fixing. Pull the shoulder belt forcibly to adjust the tightness degree of hip belt.

Loose or heavy clothing will hamper close wearing the seat belt. Do not place any object (such as hand bag and mobile phone) between the seat belt and your body.

**Height Adjustment\***

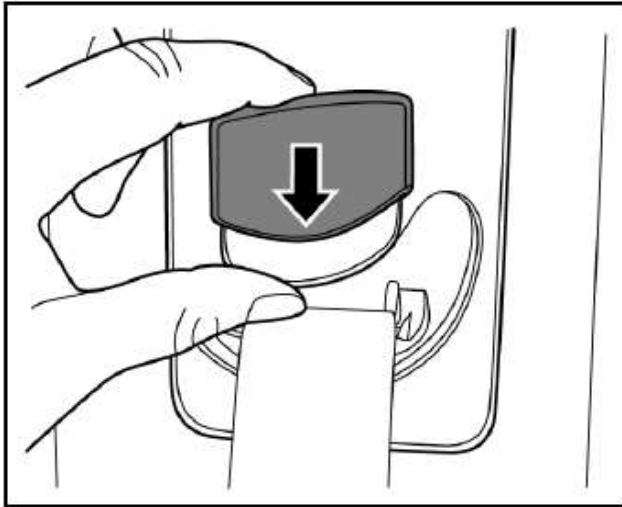

Depending on different models, the front row seat belt of some models can be adjusted in height. Press the height adjuster of the seat belt upper fixing point and move it upward or downward. Release the adjuster after adjustment.

**Unbuckle**



To unbuckle the seat belt, please press the red button on the buckle.

**Middle Row/Rear Row Seat Belt  
Left and Right Seat Belt**

For buckling and unbuckling of the left and right seat belts of the middle row, please refer to that of the front seat belt.

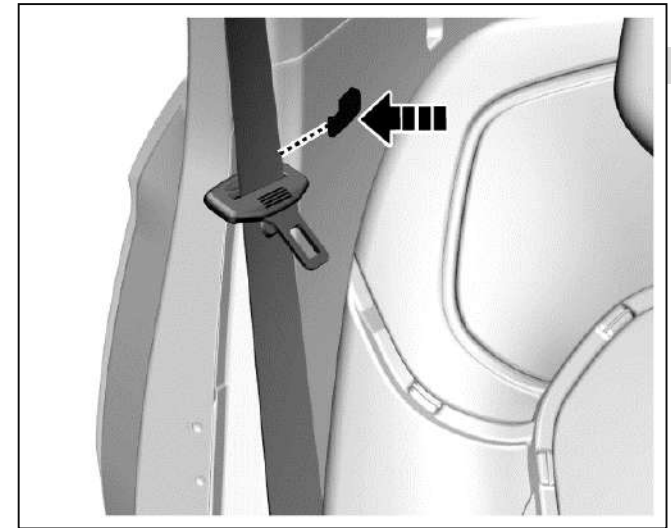

As shown in the figure, there is a clip on the trim panel near the second row seat backrest. Please hang the seat belt to the clip for fixing each time after use.

**Middle Seat Belt of Second Row**

Wearing:

1. Pull out the seat belt from the recoiler on the roof (5-seat models) or backrest (7-seat models) first and sit well.

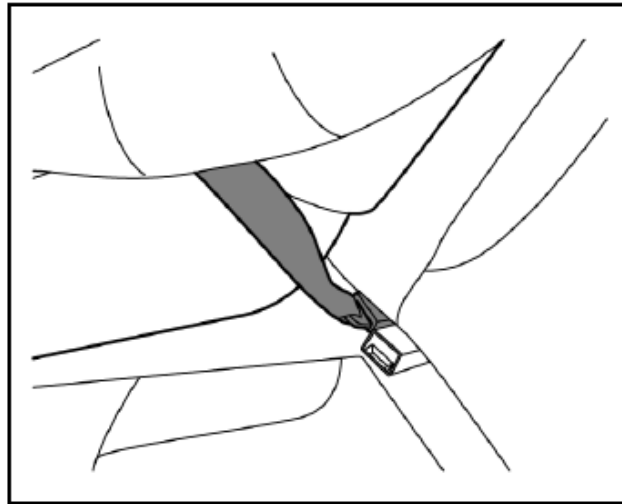

2. Plug the latch plate at the seat belt end into the small buckle on the left side of the seat.

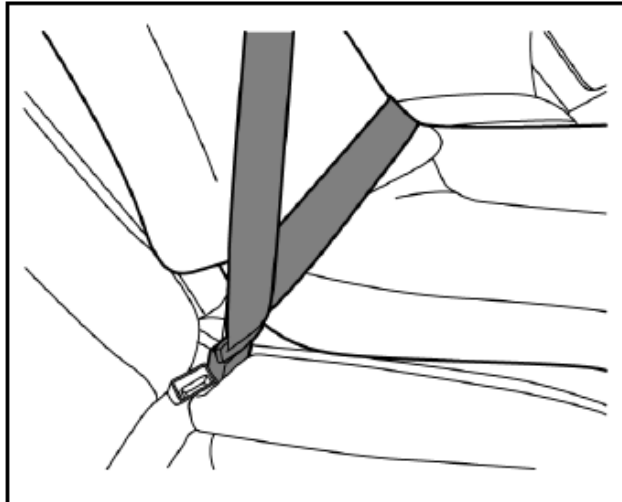

3. Plug the other latch plate (movable) into the buckle on the right side of the seat.

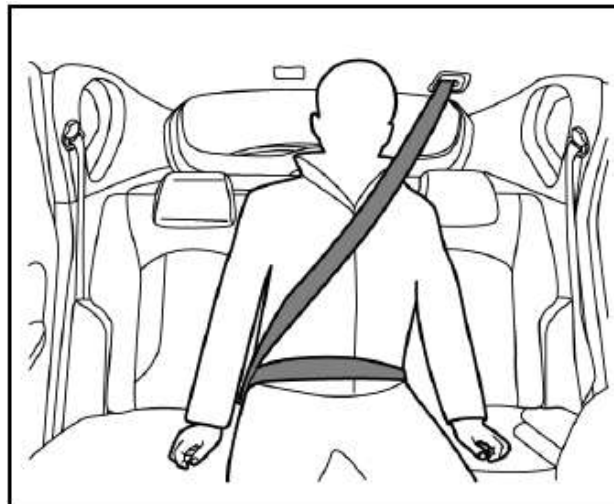

4. Check as shown in the figure above, and make sure that the seat belt goes across the occupant's body without twisting.

#### Seat Belt Use during Pregnancy

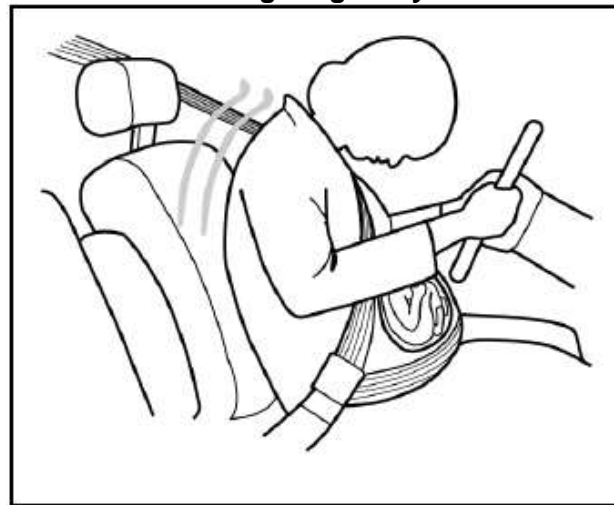

The seat belt provides protection for everybody, including a pregnant woman. Like all passengers, if pregnant women do not wear the seat belt, severe personal injuries are more likely to be caused to them. The pregnant woman shall wear the hip/shoulder seat belt during the whole pregnancy, and the hip belt shall be fastened as low as possible. The best way to protect a fetus is to provide safety protection to its mother. If the seat belt is fastened correctly, the fetus is not vulnerable to injury in case of a collision. For a pregnant woman or any person, correct wearing is the key to exert the best protection effect of the seat belt.

#### Warnings

**The hip belt shall be placed as low as possible to go across the pelvis, so as avoid force on the belly.**



## Child Seat

The vehicle is not equipped with a child seat. If you want to add one, a child seat that is applicable to ISOFIX “general” type can be selected. The child seat can only be placed on the second row seat. The front seat is not equipped with the anchor system bracket. The statistical data of accidents show that placing the child seat on the second row seat can largely improve the child safety.

### Caution

**For a little child, a child seat shall always be used. Never hold a child with arms while riding in the vehicle. Never allow a child to stand or kneel on a seat or in the luggage compartment when the vehicle is running.**

### Caution

**An unfixed child seat may be thrown out of the vehicle in case of a collision or emergency stop. The child seat must be correctly and securely fixed even it is not used.**

### Caution

**If the child seat is put in a closed compartment in hot weather, the child seat temperature will be very high. Make sure that the child seat temperature is not very high before putting a child in the seat. If the child is too small and the seat belt cannot provide the best protection for it, please make sure that a proper child seat is used to provide safety protection.**

### Caution

**The size and configuration range of the child seat is very wide. Not all child seats are applicable to your vehicle due to the effects of the vehicle trim as well as the seat shape and size. You have responsibility to ensure that the child seat installed matches with your vehicle and that the child seat can be connected correctly to the vehicle with the child seat anchor system. If the child seat does not match with your vehicle size and the child body figure or the connection to your vehicle is incorrect, severe personal injuries will be caused to the child and other passengers in the vehicle in case of a collision.**

## Child Restraint System Type



According to GB27887-2011, the child restraint system can be classified as the following 5 groups:

Group 0: for child with body weight less than 10 kg.

Group 0+: for child with body weight less than 13 kg.

Group I: for child with body weight more than 9 kg and less than 13 kg.

Group II: for child with body weight more than 15 kg and less than 25 kg.

Group III: for child with body weight more than 22 kg and less than 36 kg.

Please select a suitable child seat according to the child body weight and body figure.

For infants under one year old, their bones are very fragile, and a backward-facing child seat shall be used.

**ISOFIX**

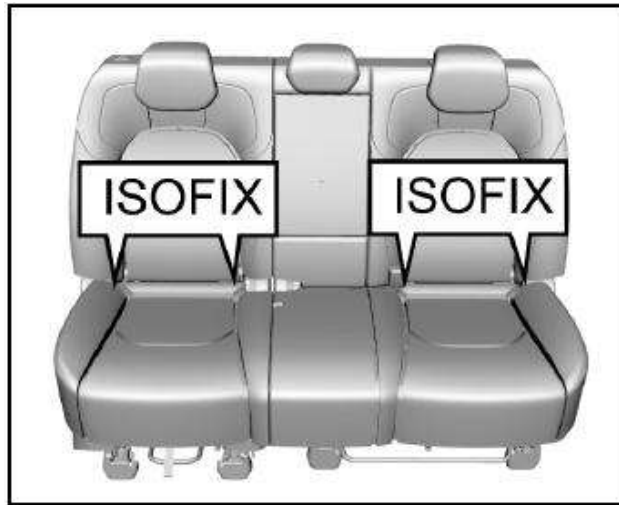

To fix the child seat:

1. The ISOFIX lower fixing point is on the joint between the second row set backrest and the seat cushion back. Its position can be identified through the label on the lower edge of the backrest. The left and right seats are equipped with a set of ISOFIX respectively.
2. Clear up the objects on the seat. Note to remove the seat belt and seat belt buckle to avoid affecting accurate fixing of the child seat.
3. Put the child seat on the second row seat.

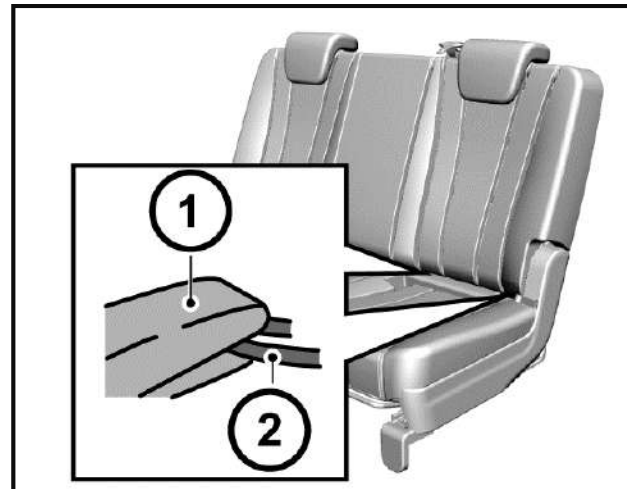

4. Connect the fixing caliper on the child seat to the on-vehicle fixing device. Operate according to the child seat instructions.

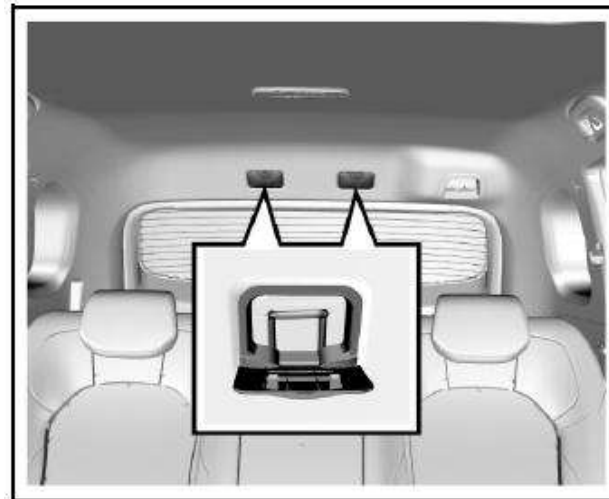

5. Connect the upper strap of the child seat to the corresponding fixing point of the vehicle. Refer to the child seat instructions to get to know when and how to strain the upper strap. As shown in the figure, the ISOFIX upper fixing point is on the roof above the rear seat. Open the outer cover from the upper edge. The child seat upper fixing point of 7-seat models is located on backside of the second row seat backrest.
6. Push and pull the child seat in all directions to make sure it is safely secured.
7. Make sure that the child seat temperature is not very high before putting a child in the seat.

In case of a serious collision accident, the ISOFIX may be damaged. It may be necessary to repair and replace some parts. Please check the ISOFIX after a collision.

### Air Bag System

Depending on the vehicle configuration, the system includes the following air bags:

- Driver frontal air bag.
- Front passenger frontal air bag. (If equipped)
- Front side air bag. (If equipped)

For all air bags, the letter "AIRBAG" is marked on the trim panel or the label near to its deployment opening. For frontal air bags, the letter "AIRBAG" for the driver is located in the middle of the steering wheel, and that for the front passenger is located on the instrument panel. For lateral-impact air bags, the letter "AIRBAG" is located on the backrest side, near to the door. The letter "AIRBAG" for side curtain air bags is located on the roof lining trim panel.

The air bag can supplement protection on the basis of correcting wearing the seat belt. Although nowadays the air bags are designed to reduce the injury risks caused by the impact force when the air bag is inflated, all air bags must be inflated rapidly to exert its effect.

The important notes about the air bag system are as follows:

**Warnings**

**Even if an air bag is equipped, you may also be injured seriously or lose your life in a collision accident if you do no use the seat belt. The air bag is designed to be used along with the seat belt but not to replace the seat belt.**

**Warnings**

**If an occupant sits next to or get too close to the air bag, he/she may be injured seriously or lose life due to inflating of the air bag. Therefore, never sit too close to the air bag.**

**Warnings**

**It is forbidden to let a child, infant, pregnant woman and the sick and weak sit on the front seat equipped with air bag. Never install a backward-facing child seat on the front seat for the child may be injured seriously or lose life when the air bag is inflated. The seat belt and air bag can protect adults and adolescents but not children and infants. Children and infants need special child protection devices (such as child seat) to get corresponding protection.**

**Air Bag Indicator**



On the instrument panel, there is an air bag indicator which displays the air bag shape symbol. The system will check whether the air bag circuit system has a fault and give corresponding prompt through the indicator. Refer to the Chapter "Instruments and Controls" for detailed information.

**Air Bag Position**  
**Frontal Air Bag**

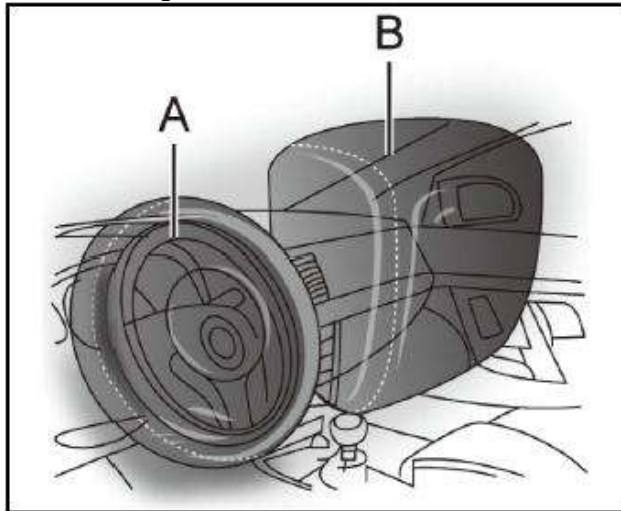

As shown in the Figure A above, the driver frontal air bag is located in the middle of the steering wheel.

As shown in the Figure B above, the front passenger frontal air bag is located in the passenger's side instrument panel.

**Side Air Bag\***

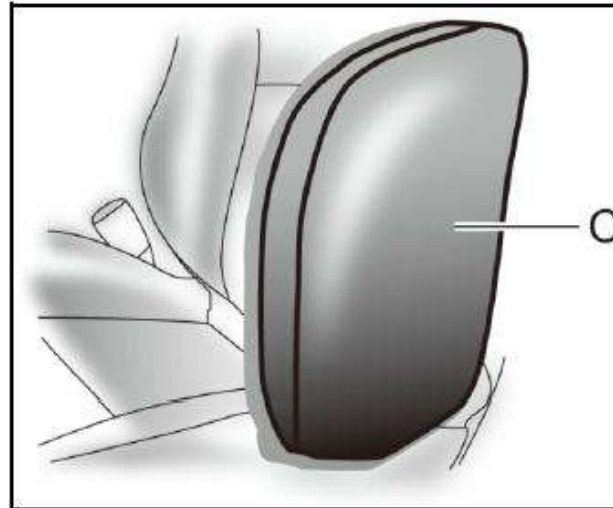

As shown in the Figure C, the front seat side air bag is installed on the backrest side near to the door.

**Side Curtain Air Bag\***

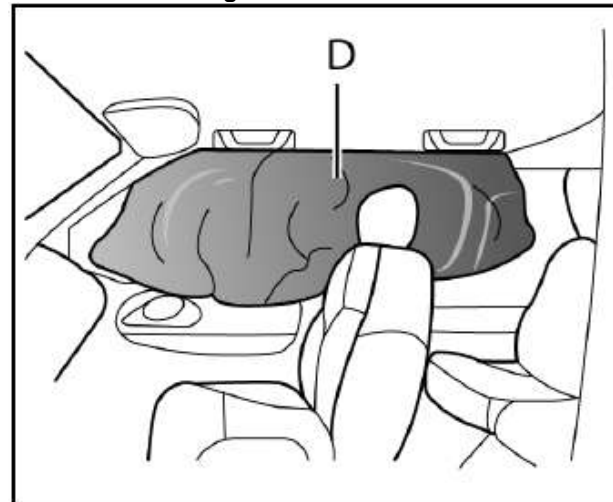

**Warnings**

If there is any other object between the occupant and the air bag, the air bag may not be able to be inflated normally or the air bag may cause the object to squeeze the occupant's body when it is inflated, leading to severe injuries or even death. Please never use a seat accessory (such as seat jacket) that may hinder the inflating of the lateral-impact air bag.

**When Shall the Air Bag Be Inflated?**

The frontal air bag is designed to be inflated in moderate to severe head-on collision or almost head-on collision to reduce severe injury risks of the driver's and the front passenger's head and chest.

Whether the frontal air bag is inflated do not mainly depends on the vehicle running speed. It depends on the impacted object, impact direction and vehicle deceleration within unit time during collision.

The frontal air bag may be inflated in different collision speed. The air bag inflation depends on the impact direction (straight or in certain angle) at the moment of collision and whether the impacted object is fixed or movable, deformable or not and narrow or wide. Due to different design of each vehicle, the collision inflation conditions of the frontal air bag may vary. The frontal air bag will not be inflated in case of vehicle overturn, rear-end collisions and most lateral-impact collisions. The frontal air bag may not be inflated in slight head-on or nearly head-on collisions, lateral or diagonal collisions, collisions to cylindrical objects (such as telegraph pole and tree trunk), rear-end collisions under large vehicle (trucks, etc.) breast board and lateral glancing collisions. As per the design, the seat lateral-impact air bag and the side curtain air bag will be inflated according to the impact position in case of the moderate to severe lateral collisions.

The seat lateral-impact air bag will not be inflated in case of head-on collisions, nearly head-on collisions, vehicle overturn or rear-end collisions. The seat lateral-impact air bag may not be inflated in slight side collisions and lateral-frontal or diagonal collisions.

As per the design, the seat lateral-impact air bag and the side curtain air bag will be inflated on the side to which the vehicle is collided. The air bag will not be triggered in all collision accidents. For a particular accident, it shall not simply judge whether the air bag should be inflated according to the causalities, vehicle damage or repair and maintenance expenses. Your vehicle is equipped with a collision sensing and diagnosis module. If a collision accident reaches certain strength, the module may record relevant collision information after the collision. If you have any doubt on the working situation of your air bag in a collision accident, please contact the Aftersales Service Center timely to provide professional analysis and diagnosis for you.

#### How Is the Air Bag Inflated?

In the inflation process, the sensing system will send an electronic signal to trigger the gas generator; the generator will release gas to inflate the air bag and to make the air bag pops up from the cover plate. The gas generator, air bag and relevant members are all components of the air bag module.

#### How Does the Air Bag Provide Protection?

The air bag supplements protection provided by the seat belt by distributing the impact force more evenly to the occupant's body. However, some occupants' bodies do not move toward the air bags in collisions where an external object intrudes into the vehicle. The air bag cannot provide corresponding protection. The air bag shall only be deemed as a supplementary device of the seat belt.

#### What Will Your See After the Air Bag is Inflated?

After the air bag is inflated, it will be deflated quickly. Somebody may not note that the air bag is ever inflated because the bleeding speed is very fast. For deflated air bag, some smoke and dust may come out from its air event.

#### Warnings

**When the air bag is inflated, there may be dust spread in the air. All persons in the vehicle shall get off the vehicle as soon as possible. If you have a breathing problem and cannot get off the vehicle, open windows or doors to get fresh air. If you have a breathing problem after the air bag is inflated, please see a doctor as soon as possible.**

If the vehicle power supply system can still function normally after a collision, the vehicle has the functions of unlocking doors automatically, turning on the hazard warning lamp and cutting off the fuel system after the air bag is inflated. The driver can use corresponding function switch to lock doors, turn off indoors lamps and turn off the hazard warning lamp.

The deployment of the front passenger air bag may also cause damage to the windshield.

- The air bag can only be inflated once as per its design. After the air bag is inflated, some parts of the air bag system need to be replaced. If you do not have these parts replaced, the air bag system will be unable to provide protection in next collision accident. The air bag system parts that shall be replaced include the air bag module, air bag control module, seat belt pretensioner and other parts.
- Work related to the air bag system can only be done by technicians with corresponding qualification. Improper repair and maintenance may cause that the air bag system cannot function normally. Please drive to the Aftersales Service Center for repair and maintenance.

**Air Bag System Repair, Maintenance and Replacement**

The air bag system must be maintained by qualified and professional technicians. Improper maintenance will cause that the air bag system cannot function normally. Please drive to the Aftersales Service Center for repair and maintenance of the air bag system.

**Warnings**

If the air bag cover is damaged, opened or broken, the air bag may not function normally. It shall be repaired as soon as possible.

**Warnings**

Never stick or cover any object on the air bag cover surface or refit the air bag cover; never try to repair, adjust or remove or install any air bag system component; never try to refit the front bumper of the vehicle body by yourself.

**Other Situations Where the Air Bag May Be Inflated (Deployed) Except for Collision**

If the vehicle bottom is impacted seriously, the air bag may also be inflated. Refer to the following examples.

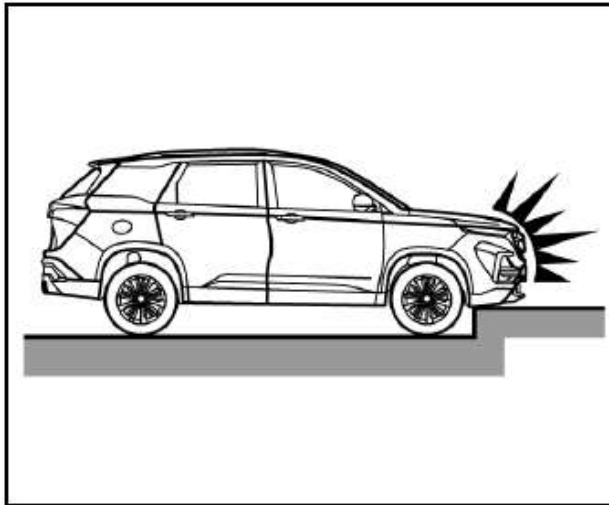

- Hit a road shoulder, sidewalk edge or hard surface.

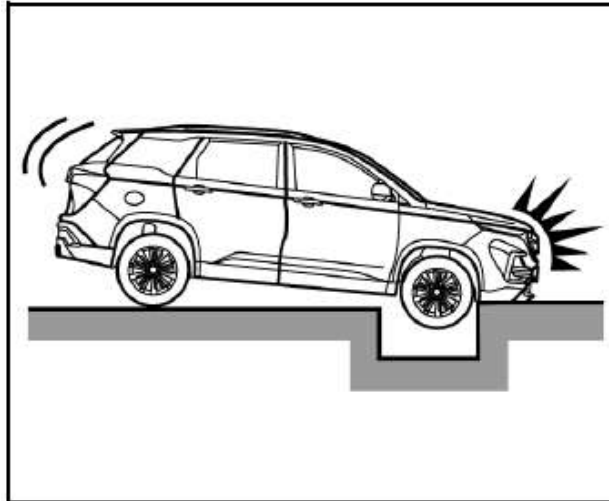

- Fall into or drive into a deep pit

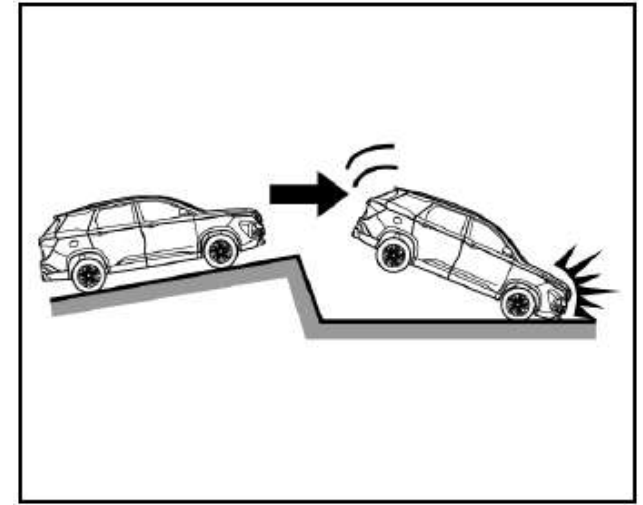

- Wheel hard landing or vehicle fall
- The Frontal Air Bag May not Be Inflated in the Following Collisions**
- The frontal air bag will usually not be inflated in case of side collisions, rear-end collisions, turnover or low-speed head-on collisions. No matter what kind of collision, only when the vehicle generates sufficient forward deceleration, will the frontal air bag be inflated.

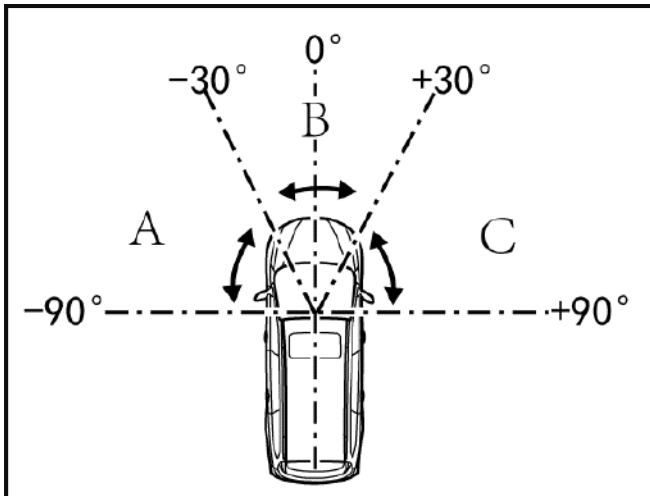

● Head-on collision angle over 30° from vehicle longitudinal direction

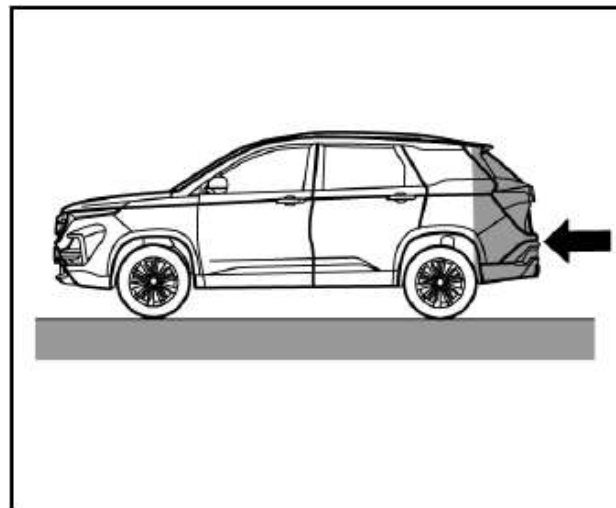

● Rear-end collision

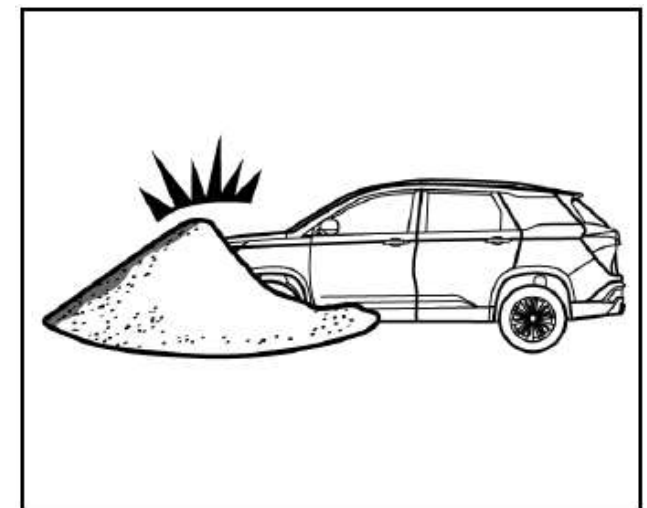

● Hit deformable objects, such as sandpile, guard bar, column and tree

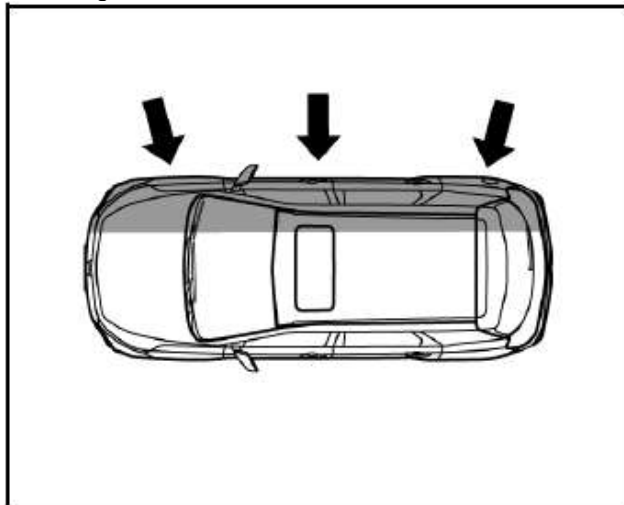

● Side collision

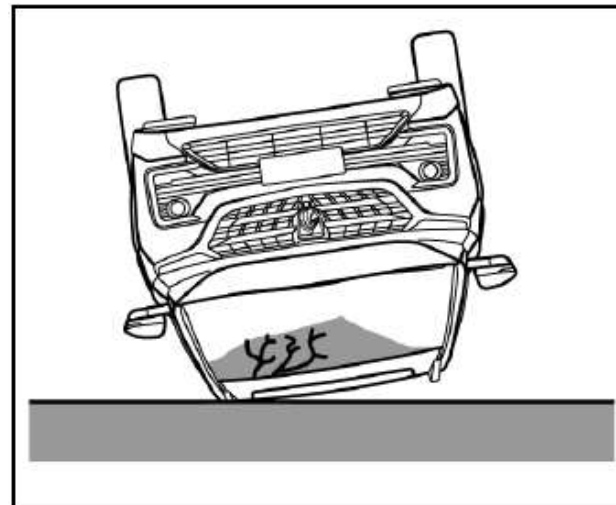

● Overturn, falling from high place, rolling

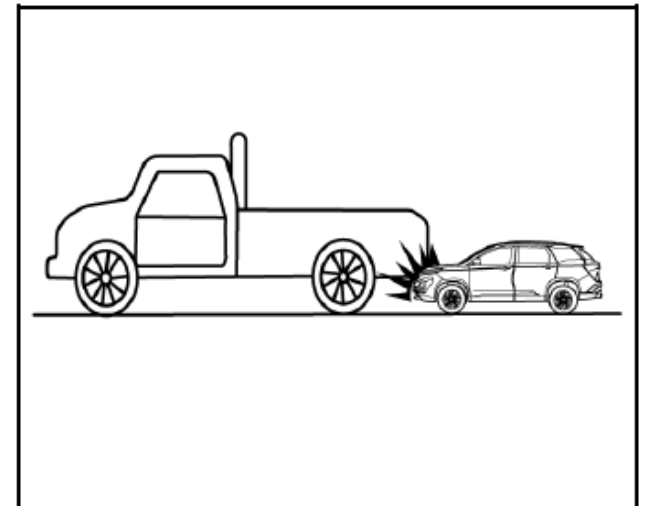

● Hit into front vehicle bottom, especially truck bottom

**Side Air Bag/Side Curtain Air Bag (If Equipped) May not Be Inflated in the Following Collisions**

In case of side collisions with certain angle or collisions to vehicle body side (not passenger compartment), the side air bag/side curtain air bag system may not be activated.

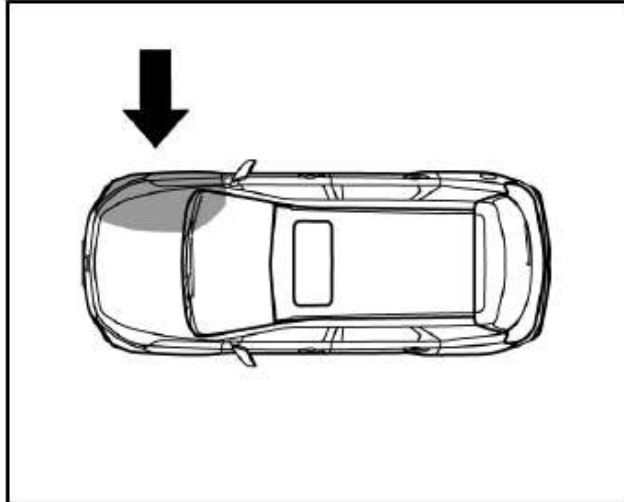

- Vehicle body side (not passenger compartment) collision

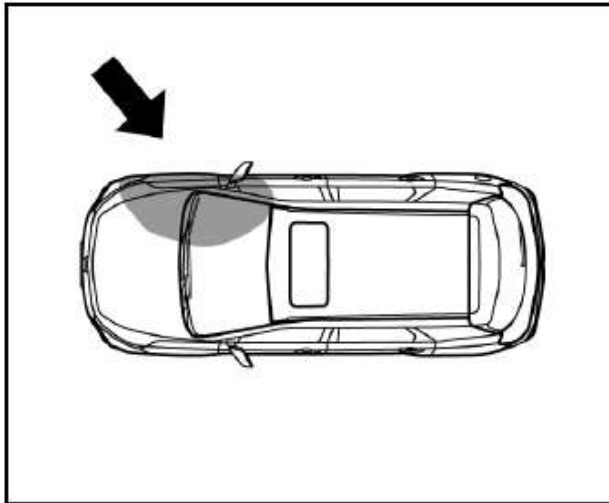

- Off-vertical side collision  
The side air bag/side curtain air bag will usually not be inflated in case of head-on collision, rear-end collisions, overturn or low-speed side collisions.

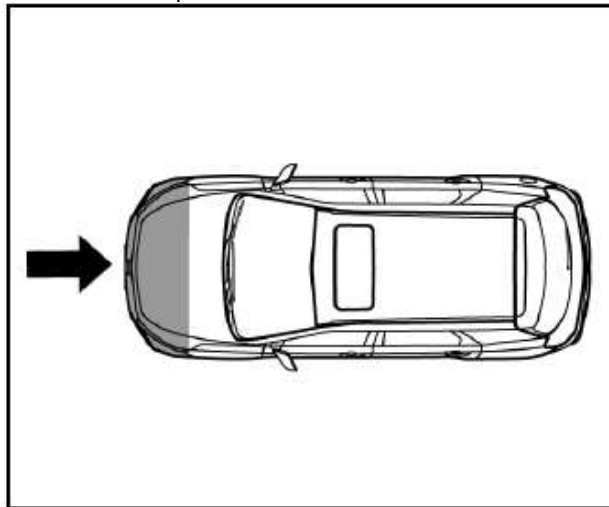

- Head-on collision

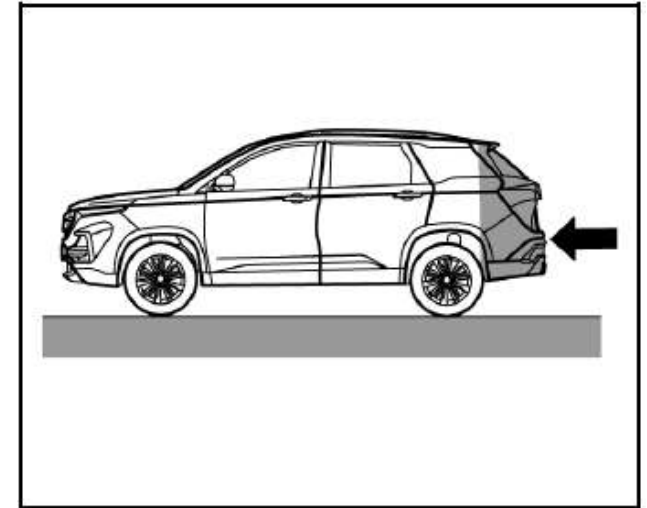

- Rear-end collision

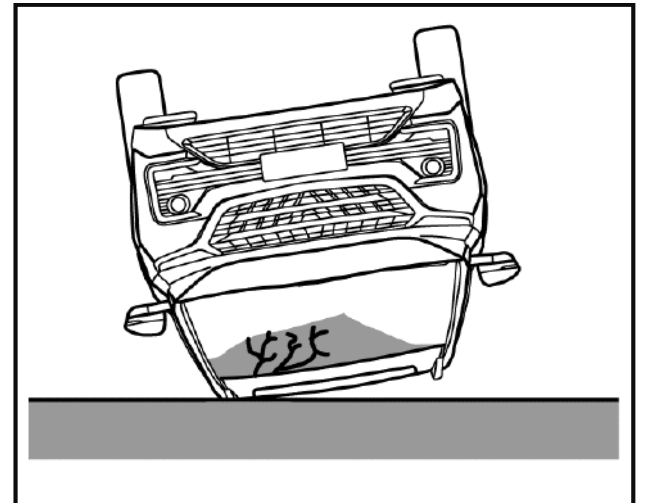

- Overturn, falling from high place, rolling



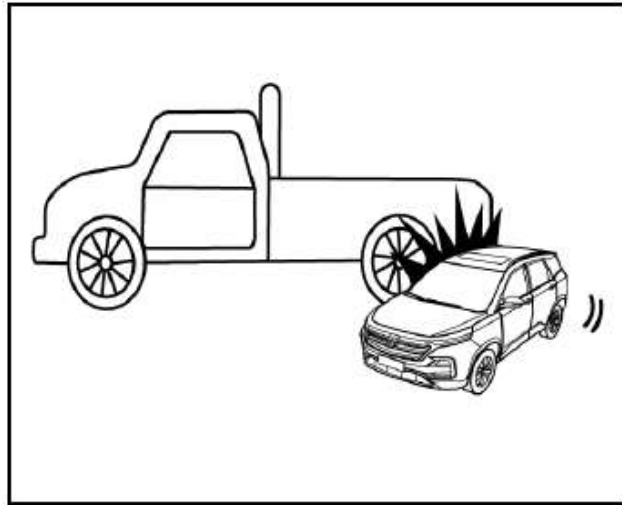

- Side collision to truck during drifting

**Important Note**



Do not use a backward-facing child restraint system on a seat (front seat) protected by a frontal air bag (in activated state). Otherwise, severe injuries or even death may be caused to the child when the air bag is deployed.

## Storage

Storage Box.....	43
Instrument Panel Left Storage Box .....	43
Instrument Panel Central Storage Box.....	43
Armrest Storage Box.....	43
Glasses Box* .....	43
Console Storage Box* .....	44
Glove Box .....	44
Map Pocket .....	44
Cup Holder .....	45
Door Storage Groove and Armrest .....	45
Rear Side Wall Storage Groove and Armrest.....	45
Backrest Hook .....	46
Card Slot .....	46
Ashtray* .....	46
Luggage Compartment Cargo Cover* .....	47
Roof Rack.....	48
Load Information .....	48

**Storage Box**

**Instrument Panel Left Storage Box**

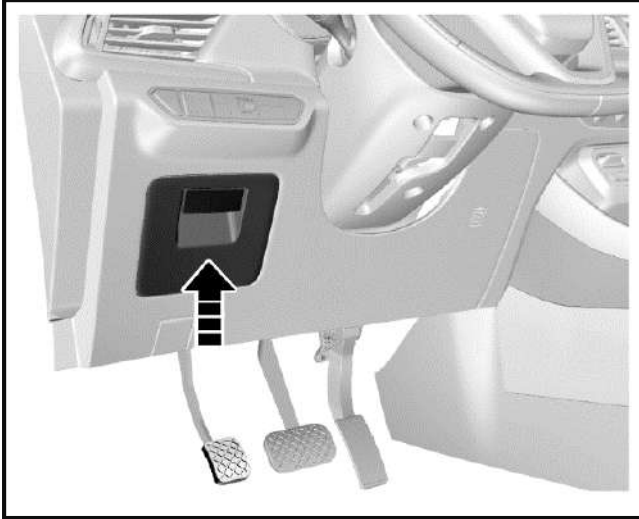

**Instrument Panel Central Storage Box**

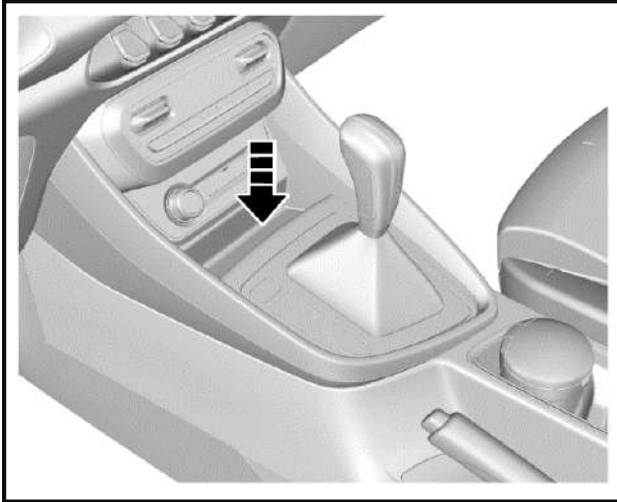

The storage box is under the air-conditioning control panel.

**Armrest Storage Box**

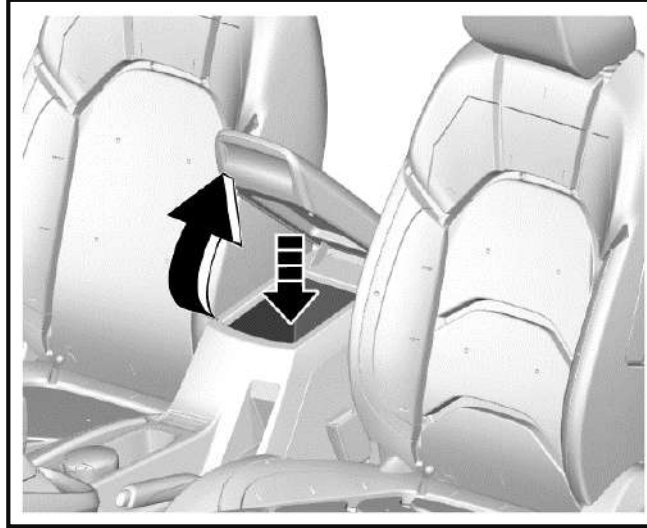

It is located between the front seats. Pull up the storage box cover to open it. Close the storage box cover after using the box.

**Glasses Box\***

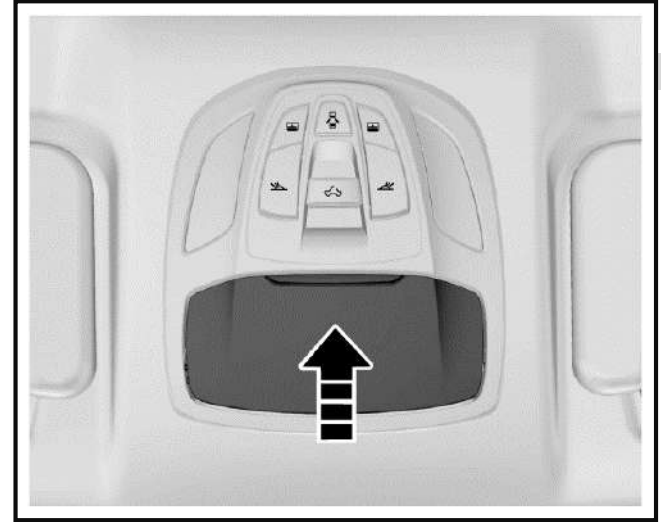

If equipped, the glasses box is located on the roof. As shown in the figure, press the outer cover, and the glasses box will pop up automatically. Close the glasses box after use.

### Console Storage Box\*

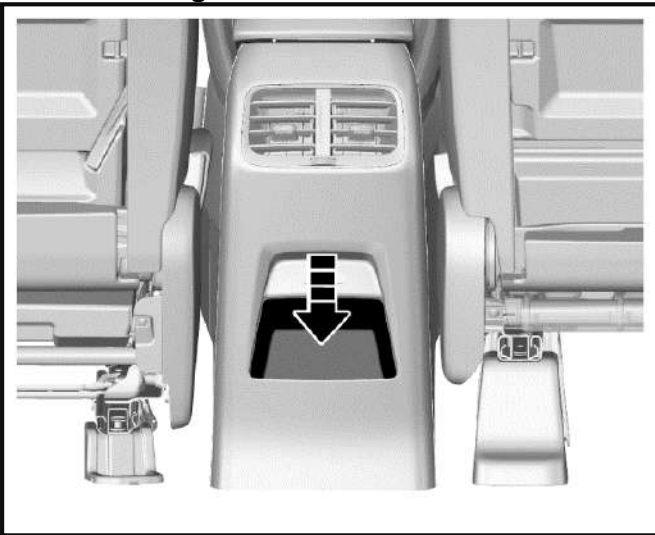

It is behind the armrest box.

### Glove Box

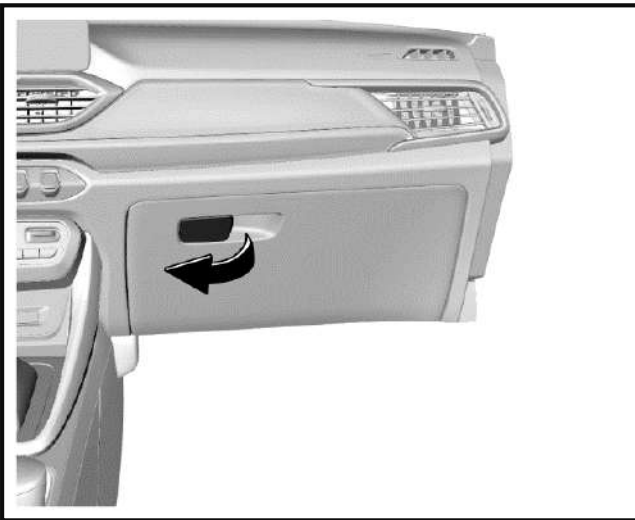

Pull the handle outward to open it. To close, push and fasten the glove box door inward.

#### Warnings

Keep the glove box door closed when the vehicle is running to reduce the injury risks in case of accidents or emergency braking.

### Map Pocket

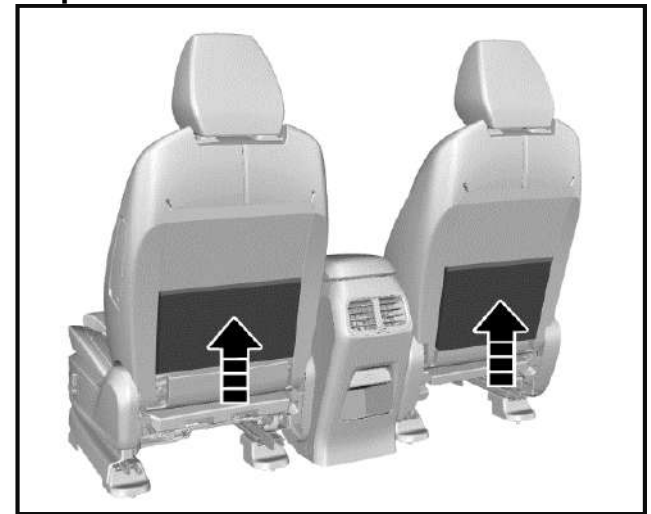

The map pocket is located on the backside of the front seat backrest.

### Cup Holder

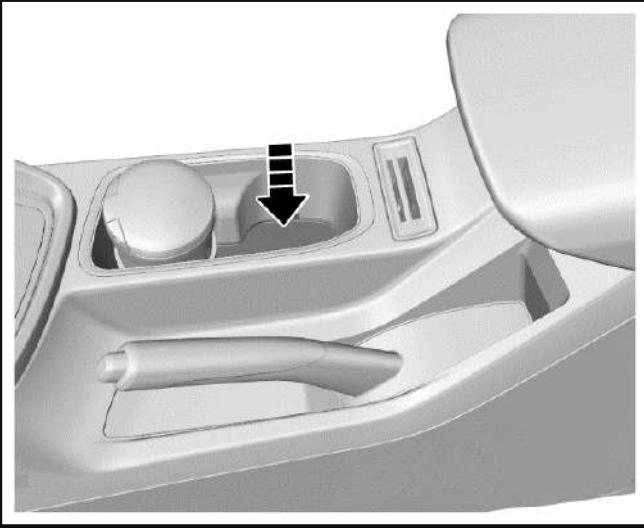

The cup holder is located on the console between the front seats. There are 2 cup holders on the rear row seat middle armrest.

#### Warnings

**When the vehicle is running, it is forbidden to place a container that contains fluid but is not covered in the cup holder. If the fluid spills out, scald may be caused, or you may lose control on the vehicle due to distraction, leading to an accident.**

### Door Storage Groove and Armrest

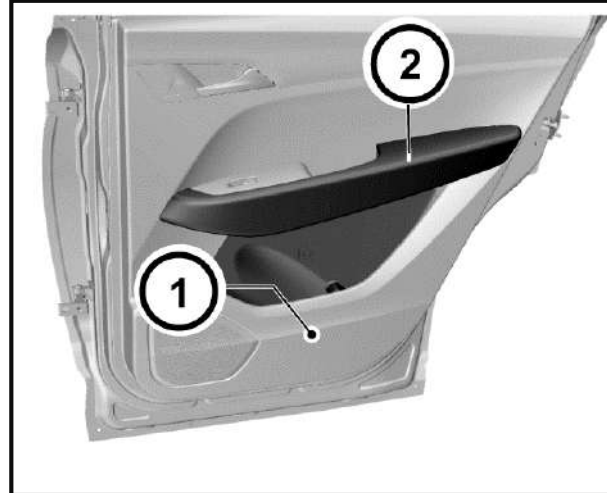

The door storage groove and armrest are located on inner side of the door panel.

### Rear Side Wall Storage Groove and Armrest

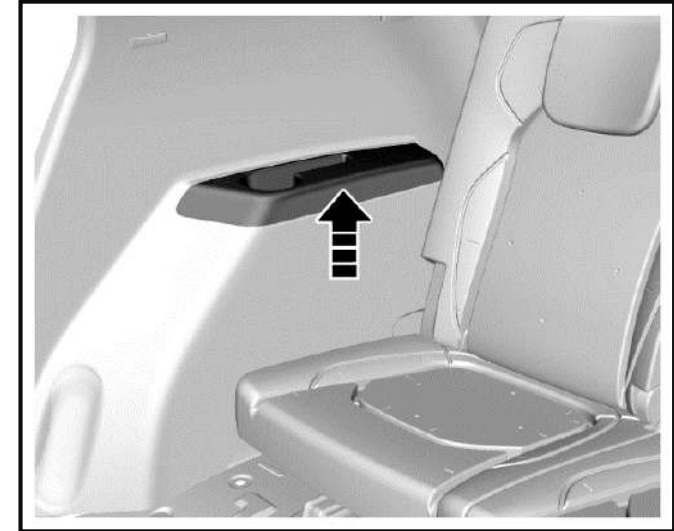

They are located on the left and right rear side walls of 7-seat models.

### Backrest Hook

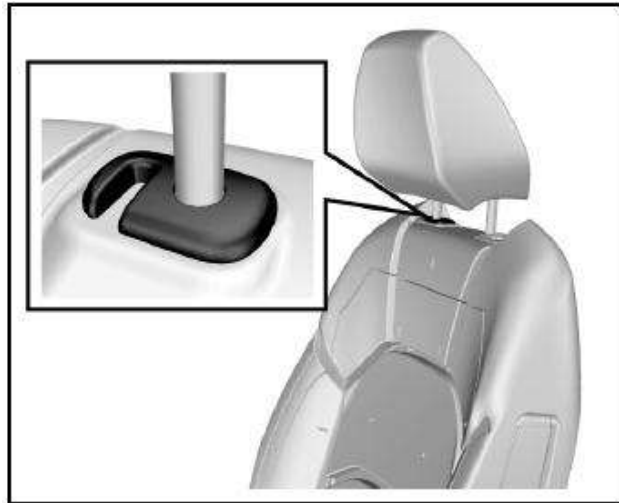

On the junction of each seat backrest and headrest, there is a hook. You can hang a shopping bag or other suitable object on the hook according to the demand.

### Card Slot

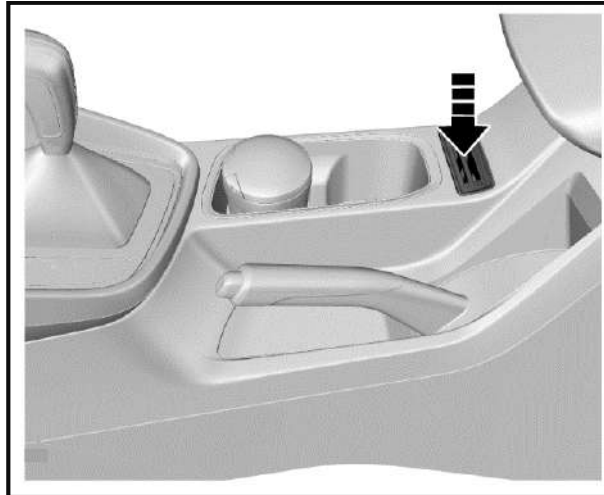

On the console, there is a card slot for card placing.

### Ashtray\*

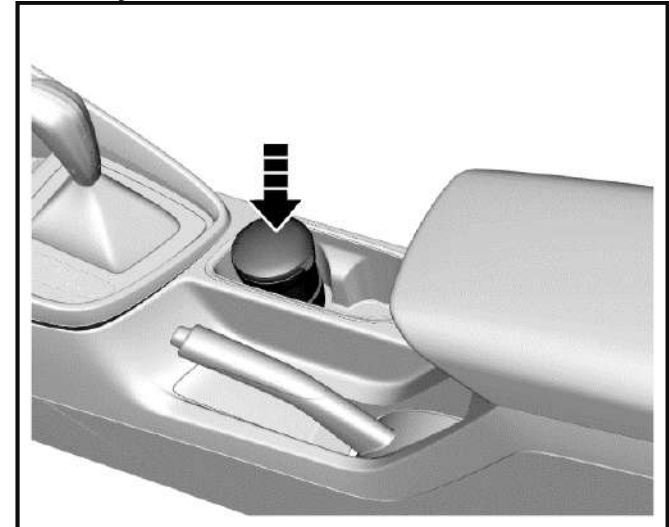

The ashtray can be moved for use. You can put it in the cup holder. Open its cover for use.

#### Caution

The ashtray can only be used for containing cigarette ash not combustible rubbish.

### Luggage Compartment Cargo Cover\*

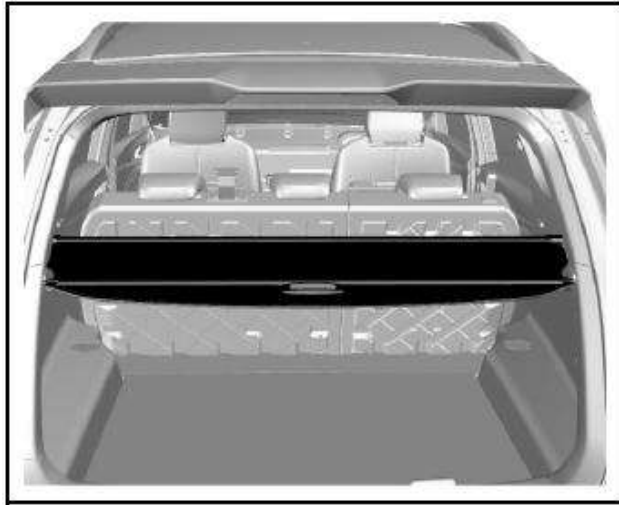

The cover is used to shield the objects in the luggage compartment.

#### Packing Up Luggage Cover

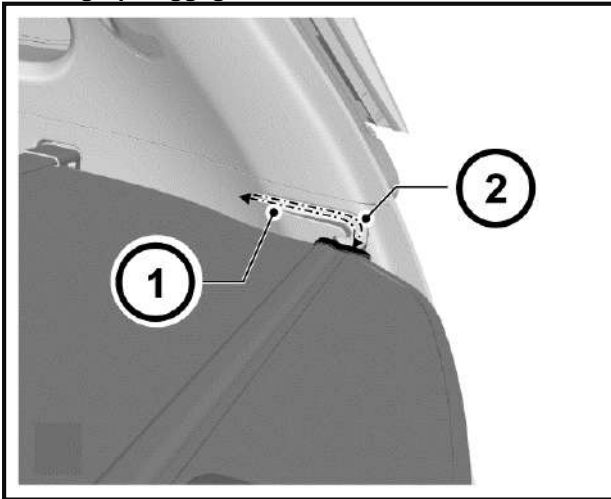

As shown in the figure, release the luggage cover plates from the guide slots on both sides of the luggage compartment, and the cover will retract automatically. To deploy the luggage cover, pull the luggage cover from the recoiler, and clamp the two ends of cover plate into the guide slots on both sides of the luggage compartment.

#### Luggage Cover Removal

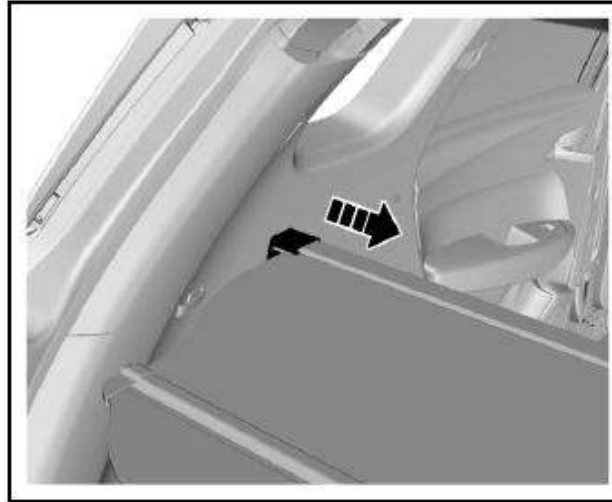

As shown in the figure, press the caps on both ends of the luggage cover recoiler toward the middle to remove the luggage cover from the vehicle.

To install the cover, press the caps on both ends toward the middle, and align the caps to the slots and then release the caps to fix the recoiler in the slots.

**Warnings**  
Do not place any object on the luggage compartment cargo cover. On one hand, the luggage cover cannot bear loads; on the other hand, the object may hurt occupants under emergencies.

**Warnings**  
Please place and fix the removed luggage cover properly; otherwise, the removed luggage cover may hurt occupants under emergencies.

### Roof Rack

The roof rack is an external trim item. To avoid damaging the vehicle, please do not use the rack to load heavy objects.

### Load Information

- The heavy objects inside the luggage compartment shall be placed close to the backrest. Make sure that the backrest is fastened. If objects need to be piled in layers, heavy ones shall be placed in the bottom.
- Objects scattered in the luggage compartment shall be fixed to prevent them from sliding.
- The loaded object shall not be higher than the upper edge of the backrest.
- Any object shall not be placed on the luggage cover or the instrument panel. It is forbidden to cover the air bag or other parts on the instrument panel.
- The objects loaded shall neither hinder the operation of pedals, parking brake and shift lever nor limit the free movement of the driver. Do not put any object not fixed in the vehicle.
- Do not drive the vehicle when the liftgate open.

#### **Warnings**

**It is forbidden to place a cigarette lighter, propane gas cylinder, perfume or other combustible/explosive materials in the vehicle. These articles may be on fire or explode when the vehicle is under high temperature for a long time.**



# Instruments and Controls

- Instrument Panel ..... 50
- Controls ..... 51
  - Horn ..... 51
  - Steering Wheel Adjustment ..... 52
  - Front Windshield Wiper and Washer ..... 52
  - Rear Windshield Wiper and Washer\* ..... 53
  - Cigar Lighter ..... 53
  - Exterior Entertainment Power Outlet\* ..... 54
- Warning Lamps, Gauges and Indicators ..... 55
  - Speedometer ..... 55
  - Tachometer ..... 55
  - Fuel Gauge ..... 55
  - General Odometer ..... 55
  - Small Odometer ..... 56
  - Engine Coolant Temperature Gauge ..... 56
  - Type-I Trip Computer Display Screen ..... 56
  - Average Fuel Consumption ..... 57
  - Instantaneous Fuel Consumption ..... 57
  - Fuel Range ..... 57
  - Adjustment Lever ..... 58
  - Type-II Trip Computer Display Screen ..... 59
  - Door Ajar Warning Lamp ..... 65
  - Instrument Cluster Display Brightness Adjustment ..... 65
  - Type-I Trip Computer Display Screen Switch ..... 67
- Control Indicators ..... 68
  - Type-I Instrument Cluster ..... 68
  - Type-II Instrument Cluster ..... 70
  - Turn Signal Lamp/Hazard Warning Indicator ..... 71
  - Engine Oil Pressure Too Low Warning Lamp ..... 72
  - Charging System Warning Lamp ..... 72
  - Coolant Temperature Too High Warning Lamp ..... 73
  - Front Fog Lamp Indicator\* ..... 73
  - Rear Fog Lamp Indicator ..... 73
  - Headlamp High Beam Indicator ..... 73
  - Position Lamp Indicator ..... 74
  - Engine Malfunction Indicator Lamp (MIL) ..... 74
  - ABS Fault Warning Lamp ..... 74
  - EPS Fault Warning Lamp ..... 75
  - Airbag Fault Warning Lamp ..... 75
  - Brake System/EBD Warning Lamp ..... 76
  - Engine Immobilizer System Indicator ..... 77
  - Driver Fasten-Seat-Belt Warning Lamp ..... 77

- Front Passenger Fasten-Seat-Belt Warning Lamp\*78
- ESC Fault Warning Lamp ..... 80
- ESC OFF Indicator ..... 80
- Transmission Fault Warning Lamp\* ..... 80
- Cruise Control System Working Condition Indicator\* ..... 81
- TPMS Fault Indicator\* ..... 81
- Reverse Sensor\* ..... 82
- Reverse Video Display\* ..... 82
- Parking Assist System\* ..... 84

### Instrument Panel

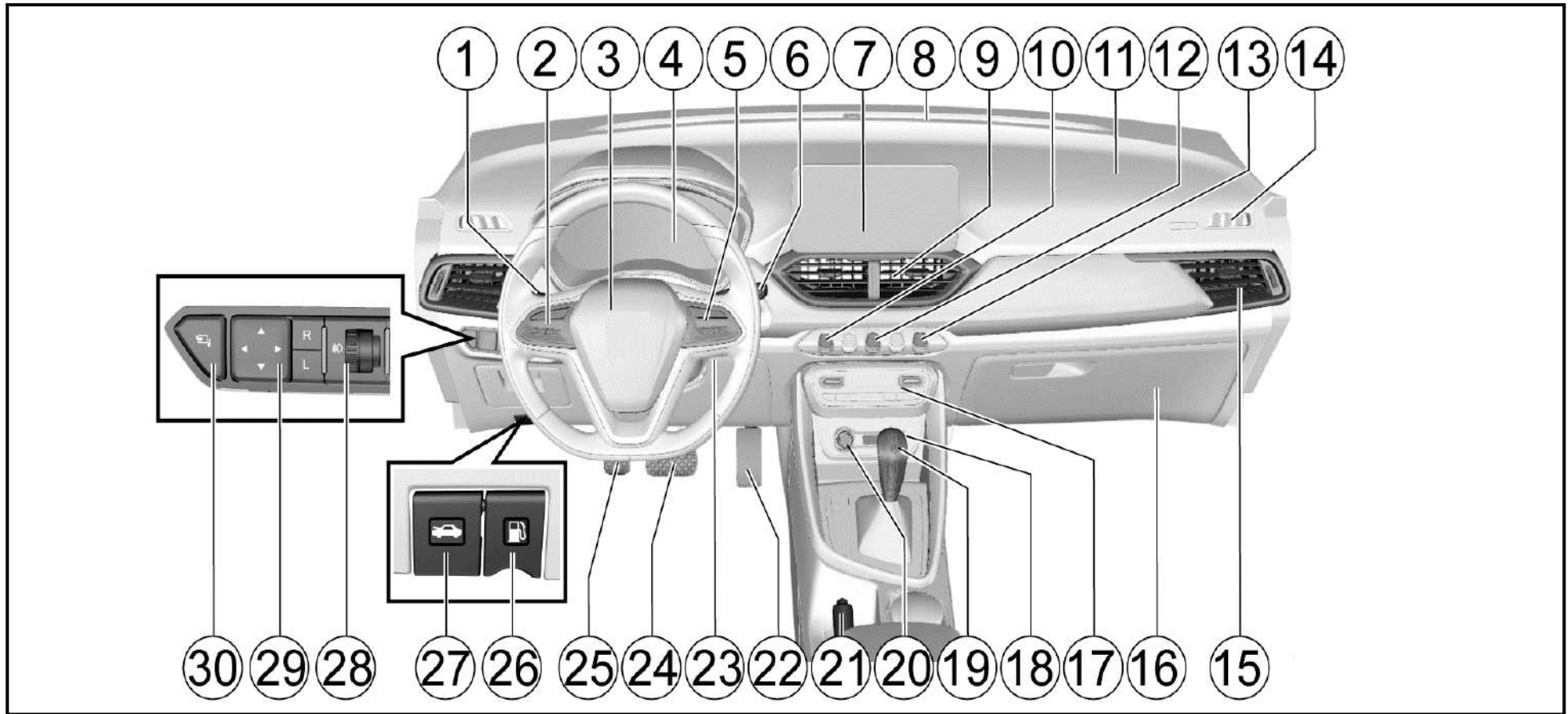

1. Vehicle lamp and turn signal lamp switch
2. Cruise control system control button\*
3. Airbag - driver/horn switch
4. Instrument cluster
5. Audio system control button\*
6. Wiper and washer switch
7. Vehicle audio
8. Front air outlet
9. Central air outlet
10. Central door lock switch
11. Front airbag - passenger\*
12. Hazard warning lamp switch
13. ESC OFF switch
14. Defrost air outlet for front
15. Side air outlet
16. Glove box
17. Air conditioner control panel
18. Exterior entertainment power outlet\*
19. Shift lever
20. Cigar lighter
21. Parking brake lever
22. Accelerator pedal
23. Ignition switch\*
24. Brake pedal
25. Clutch pedal
26. Fuel filler cap release lever
27. Hood release lever
28. Headlamp adjustment knob
29. Electrically operated outside rearview mirror adjustment switch
30. Outside rearview mirror electric folding switch\*

## Controls

### Horn

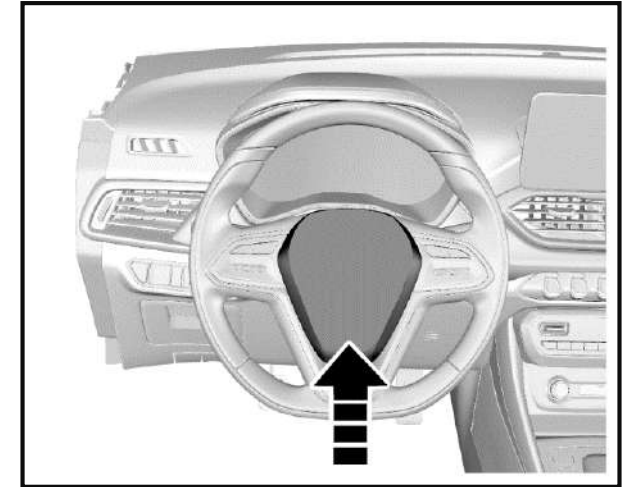

Press the switch on the steering wheel to blow the horn.

### Steering Wheel Adjustment

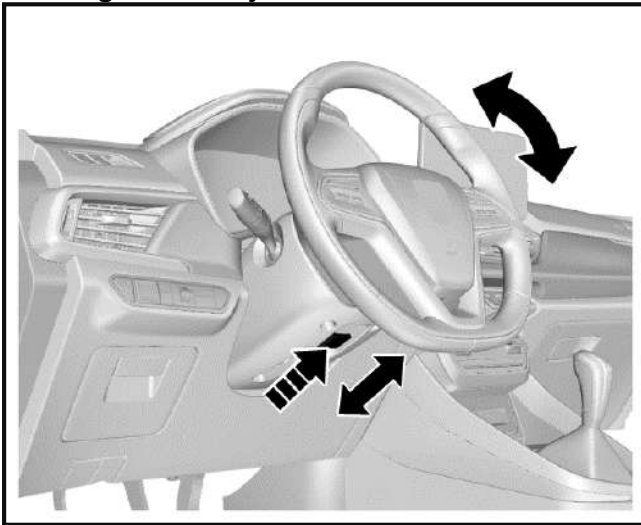

It is only allowed to adjust the steering wheel after the vehicle has fully stopped. The steering wheel can tilt upwards/downwards.

If you need to adjust the steering wheel:

1. As is shown in the figure, push the steering wheel adjustment lever outward first;
2. Adjust the steering wheel to the desired position and then pull back the adjustment lever to lock the steering wheel;
3. Check and confirm that the steering wheel has been locked firmly.

#### Caution

**The driver must keep absolute control of the steering wheel during driving. It is not allowed to adjust the steering wheel while the vehicle is running. Adjusting the steering wheel during driving can cause the vehicle out of control.**

### Front Windshield Wiper and Washer

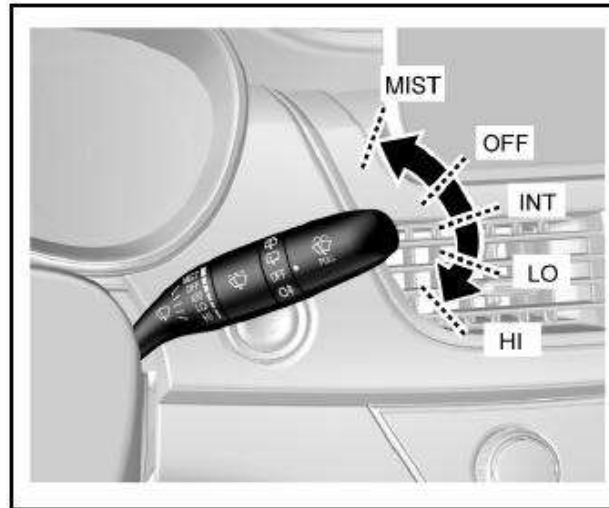

To use the front windshield wiper, turn on the ignition switch first and then push the windshield wiper/washer control lever. The front windshield wiper has the following 5 working positions:

MIST: Push the control lever up once and the wiper wipes once.

OFF: Turn the system off.

INT: Push the control lever down to this position and the wiper wipes intermittently.

LO: Push the control lever down to this position and the wiper wipes continuously at a low speed.

HI: Push the control lever down to this position and the wiper wipes continuously at a high speed.

The intermittent wiping (INT) speed is adjustable and to select the desired speed, just turn the circular knob in the middle of the control lever.

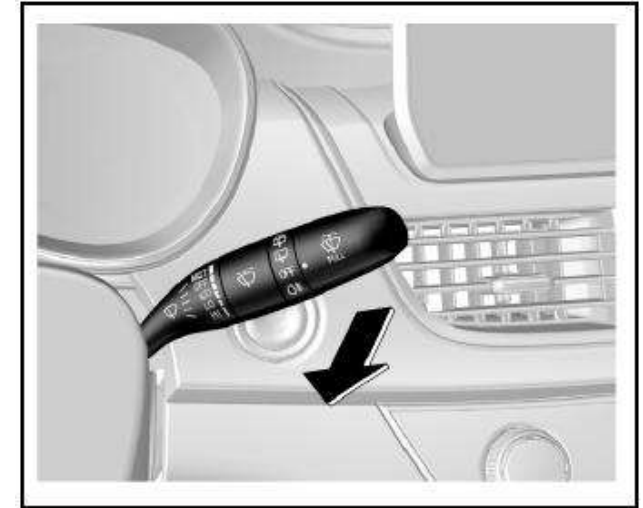

To spray cleaning fluid on the front windshield:

- Turn the ignition switch to “ON (connected)” position;
- Pull the windshield wiper/washer control lever towards the steering wheel.

Keep pulling the control lever for more than 1s or so—the washer sprays cleaning fluid to the windshield and works for 3 cycles or until the control lever is released.

**Caution**

- Blurred view of the driver can lead to accident and cause personal injuries and damage to the vehicle or other properties.
- In cold weather, if the wiper gets frozen, before using the wiper, please spray warm water on the frozen area to deice and then wipe off the water immediately to prevent icing.

**Rear Windshield Wiper and Washer\***

To use the rear windshield washer, turn the ignition switch to "ON" position first and then turn the rear wiper and washer switch knob to .

Turn the rear wiper and washer switch knob to  and the water pump sprays water to the rear windshield immediately. Release the knob and the pump stops spraying.

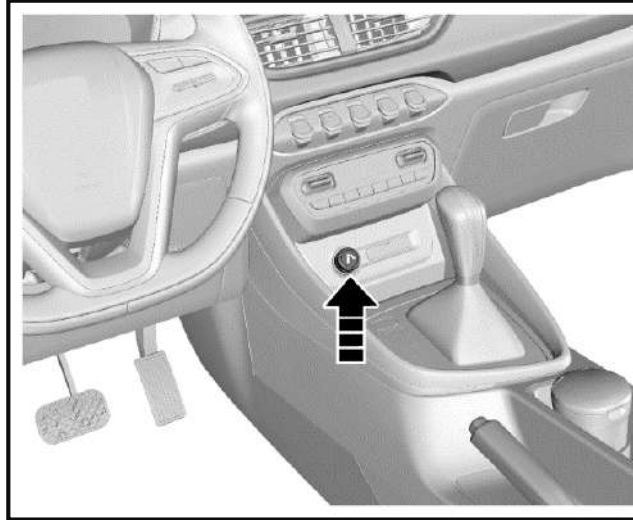
**Cigar Lighter**

The cigar lighter is installed in the instrument panel central storage box. To use the cigar lighter, turn the ignition switch to ACC (electrical accessories) or ON (connected) position and then fully push the cigar lighter in. The cigar lighter will pop out automatically as it is well prepared.

**Caution**

The cigar lighter barrel becomes very hot while working. Do not touch the cigar lighter or allow the child to operate or play with it. Hot metal can cause personal injuries or damage to the vehicle or other properties.

**Caution**

An overheated cigar lighter can damage the heating element as well as the lighter itself. Do not press the cigar lighter while it is heated, otherwise the lighter can become overheated. Do not use the cigar lighter receptacle for power supply purpose.

**Warning**

If you leave flammables or explosives in the vehicle, for example, leaving a lighter in the vehicle on a summer day, the temperature in the passenger compartment and the luggage compartment will increase, causing explosion or fire accident as a result. Therefore, please ensure that no flammables or explosives are left in the vehicle.

### Exterior Entertainment Power Outlet\*



The entertainment power outlet is located below the air conditioner control panel.  
The USB interface can be used for cellphone charging and connection of audio files.  
The charging power outlet is unavailable if the ignition switch is turned off.  
For other information about the USB interface, please refer to the *Audio System Specifications* provided together with the vehicle.

### Rear Accessory USB Power Outlet\*

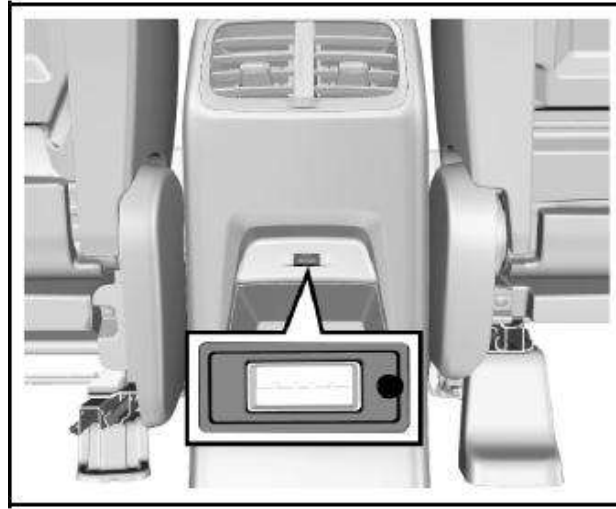

The second-row USB power outlet (5V/2A) is located at the rear end of the console and it can be used for cellphone charging. The power outlet is unavailable if the ignition switch is turned off.  
If equipped, the third-row USB power outlet is located at the third-row seat right armrest.

### Driving Recorder USB Power Outlet

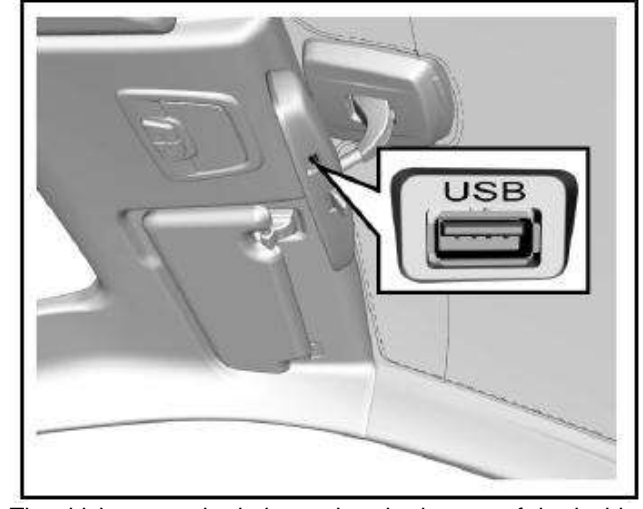

The driving recorder is located at the bottom of the inside rearview mirror and it can provide power supply for your driving recorder.

**Warning Lamps, Gauges and Indicators**  
**Speedometer**

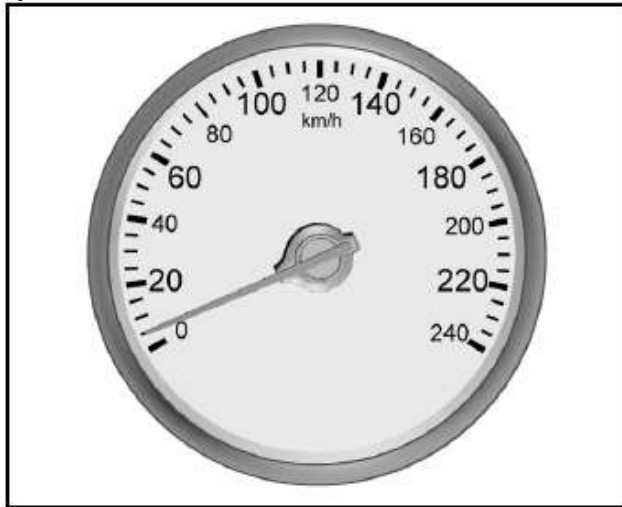

It displays the vehicle speed.

**Note**

Please keep the speed within the limit when driving in a speed limit zone.

**Tachometer**

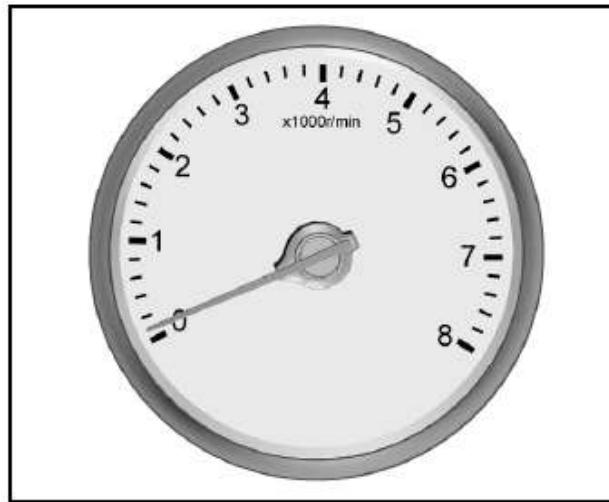

It displays the engine crankshaft revolutions per minute.

**Fuel Gauge**

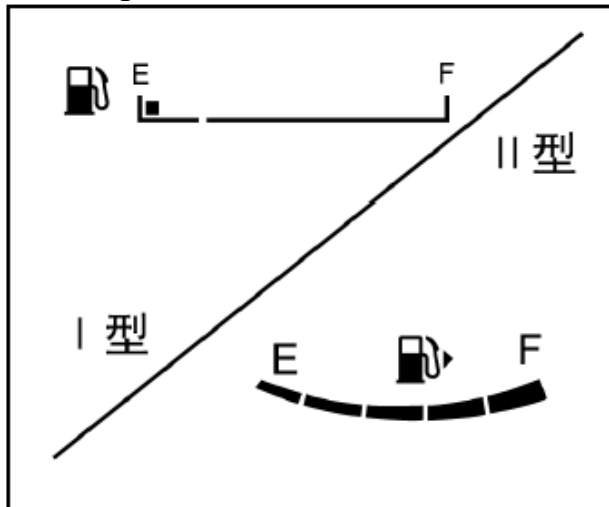

It displays the fuel level in the fuel tank.

If the fuel level in the fuel tank is too low, the control indicator will illuminate. Please add fuel immediately. It is strictly prohibited to use up the fuel in the fuel tank. As some fuel remains in the fuel tank, the adding amount can be less than the fuel tank capacity. During braking, acceleration or cornering, as the fuel in the fuel tank shakes, indication on the fuel gauge fluctuates.

**Danger**

Before adding fuel, please do stop the vehicle and shut down the engine.

**General Odometer**

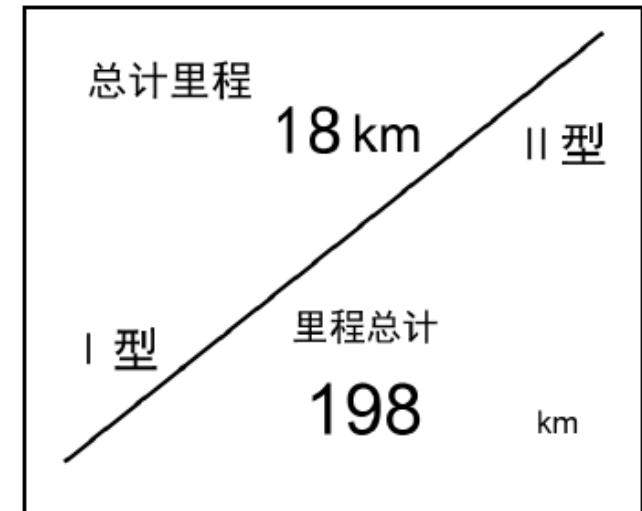

It displays the total accumulated kilometers of the vehicle.

**Note**

It is lawfully forbidden to adjust the odometer for illegal purpose.

**Small Odometer**

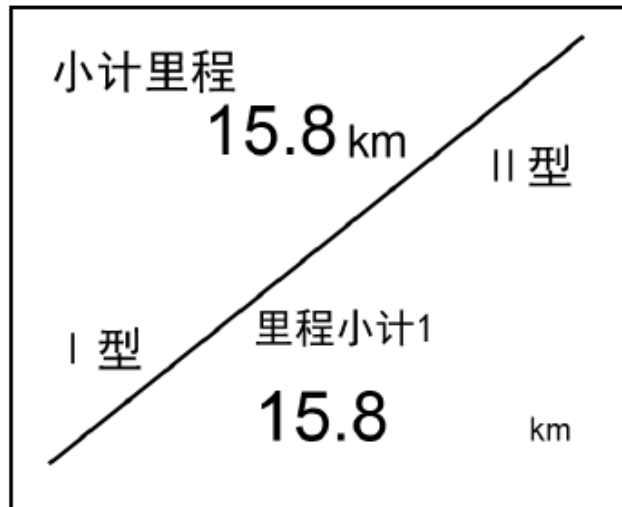

It shows vehicle kilometers for a driving trip

after it has been reset to zero. In this mode, long press the adjustment lever to clear the trip distance. You can clear the trip distance when it is displayed on the small odometer. To do this, long press “OK” button on the steering wheel if the vehicle is of high configuration; long press the instrument cluster adjustment lever if the vehicle is of low configuration.

**Engine Coolant Temperature Gauge**

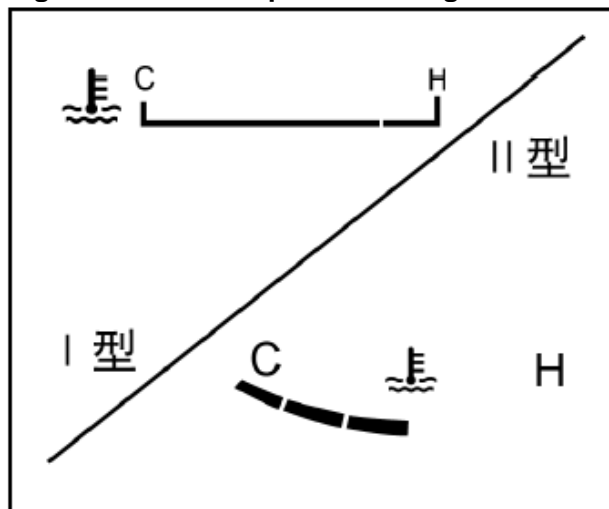

It displays the temperature of the engine coolant. “C” means “cold state” and “H” means “hot temperature”; when the coolant temperature gauge indicates within the red area, it indicates the engine is overheated. Please shut down the engine immediately for inspection.

**Caution**

**If the engine coolant temperature is too high, please stop the vehicle, shut down the engine and inspect the coolant level.**

**Type-I Trip Computer Display Screen**

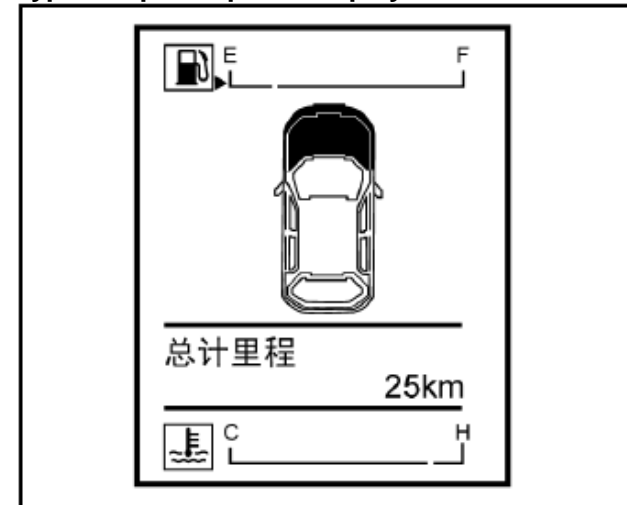

The trip computer monitor is located between the tachometer and the speedometer. It can display fuel gauge, engine coolant temperature gauge, general odometer, small odometer, fuel range, instantaneous fuel consumption, average fuel consumption, etc., depending on the vehicle configuration.



**Average Fuel Consumption**

It indicates the average fuel consumption given for reference by the driver in the current driving mode, under the current driving cycle. Average fuel consumption can help the driver develop a good driving habit and it indicates in L/100 km.

In different driving modes, the reference average fuel consumption is different.

Driving mode: driving conditions such as driving in urban area, high-speed driving, driving at different constant speeds, acceleration/deceleration condition, driving at the same speed and with different gears engaged, etc.

when driving on a slope (up or down) for a long distance, or in case of traffic jam lasting for a long time, the fuel consumption shown on the average fuel consumption gauge may be higher or lower than normal. This depends on the current driving condition and it is a normal phenomenon.

**Instantaneous Fuel Consumption**

It indicates the reference fuel consumption (in L/100 km) in the current accelerator control state and under the current driving cycle.

Driving cycle: The period from starting the engine to shutting it down represents a driving cycle.

The instantaneous fuel consumption changes real-time as the throttle valve opening, revolution speed and vehicle load change.

**Fuel Range**

It indicates the reference mileage the vehicle can continuously run for with the current remaining fuel amount. It changes as the fuel consumption under the current driving condition changes.

Fuel range is for reference only. Please add fuel as soon as possible the fuel level low indicator illuminates.

### Adjustment Lever

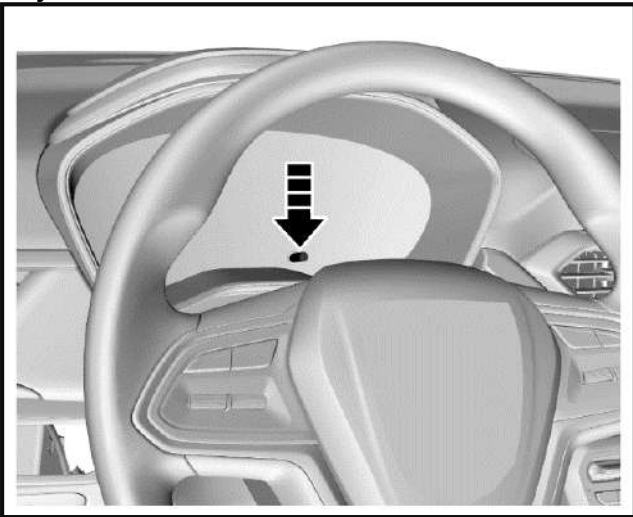

Short press or long press the adjustment lever to switch among different screens or carry out zeroing.

Long press means press for over 2s and short press means press for 2s or less.

Rotate the adjustment lever to adjust the display brightness of the instrument cluster.

For more details, please refer to “Display Screen Mode Switch”.

Type-II Trip Computer Display Screen

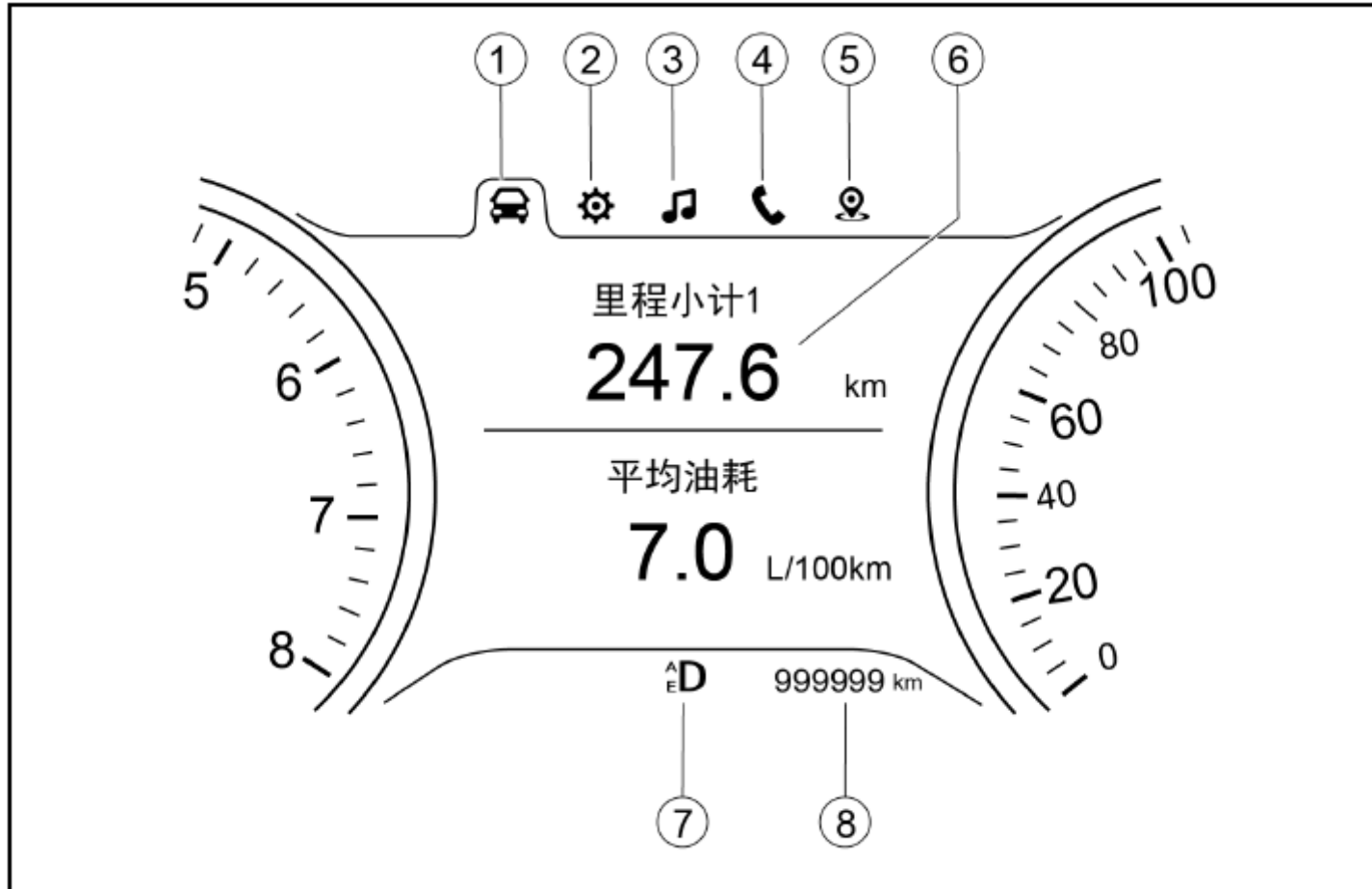

1. Trip computer information option
2. Vehicle information setup option
3. Multimedia information display option
4. Bluetooth telephone information display option
5. Navigation information display option
6. Display zone
8. General odometer

**Instrument Cluster Control Button\***

Type-II trip computer display screen can be controlled with the control button on the steering wheel. Only when the ignition switch is turned to ON can the instrument cluster be controlled.

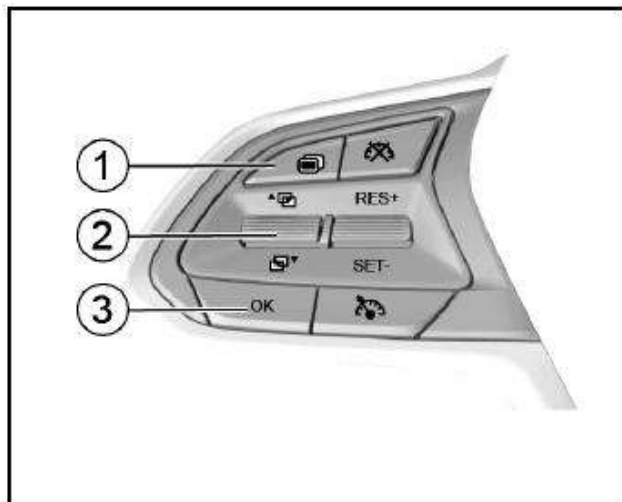
**1. Option switch button**

It is used to switch among different display screens.

**2. Up/down selection button**

Pull it up or down to make selection or adjustment.

**3. Confirm button (OK)**

It is used to confirm the setup or to clear the trip mileage or the average fuel consumption. The confirm button can be operated in two ways: short press (<2S) and long press (≥2S).

**Trip Computer Information Option**

Choose this option to indicate driving information such as odometer, average fuel consumption, current vehicle speed, instantaneous fuel consumption, driving time, fuel range, tire pressure, etc. Pull the up/down selection button to switch among the following interfaces:

**Interface 1—Trip Mileage 1/Average Fuel Consumption**

The first trip mileage and the average fuel consumption within the recent driving distance are shown. Average fuel consumption is shown in L/100 km and it can help the driver develop a good driving habit. In different driving modes, the reference average fuel consumption is different. These driving modes include driving in urban area, high-speed driving, driving at different constant speeds, acceleration/deceleration condition, driving at the same speed and with different gears engaged, etc.

On the current operation interface, if you long press “OK”, the trip mileage 1 and the average fuel consumption will be cleared. After clearing, no average fuel consumption will be shown until the vehicle has run for 0.1 km. Fuel consumed as the vehicle is idling is not included in calculation of the average fuel consumption.

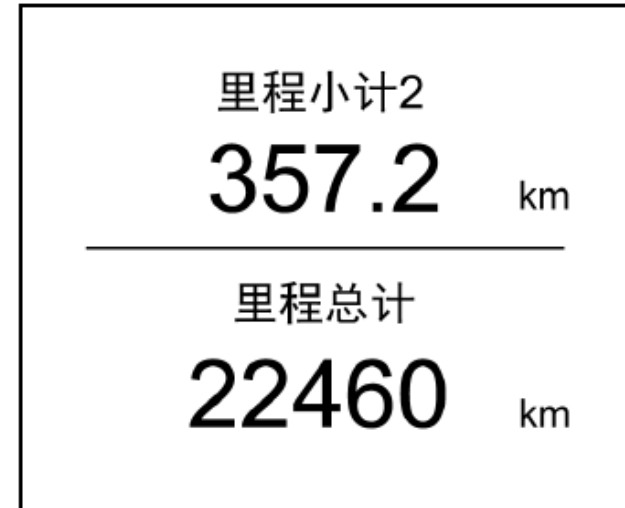
**Interface 2—Trip Mileage 2/Total Mileage**

The second trip mileage and the total mileage are shown. On the current operation interface, if you long press “OK”, the trip mileage 2 will be cleared. The total mileage cannot be cleared. The total mileage keeps identical to general odometer indication shown at the lower half of the LCD.

Interface 3—Current Vehicle Speed/Instantaneous Fuel Consumption

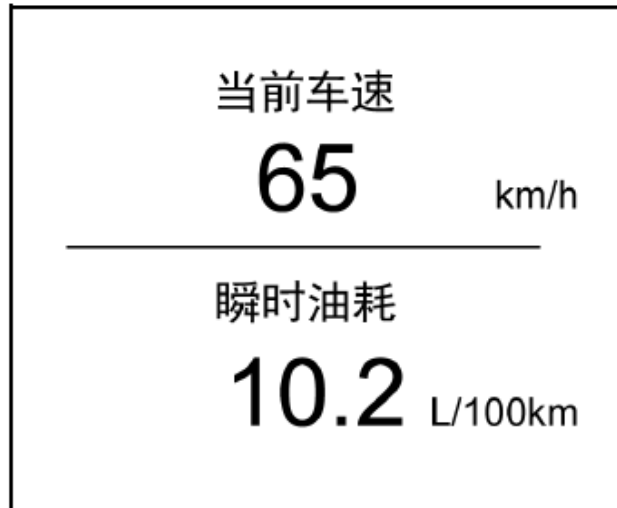

The current vehicle speed indicates the speed at which the vehicle is currently running.

Instantaneous fuel consumption indicates the reference fuel consumption (in L/100 km) in the current accelerator control state and under the current driving cycle. If the current vehicle speed is extremely low, the instantaneous fuel consumption will show in L/h (liter per hour).

The instantaneous fuel consumption changes real-time as the throttle valve opening, revolution speed and vehicle load change.

Interface 4—Driving Time/Fuel Range



Calculation of the driving time starts as the vehicle starts running and ends as the vehicle stops. The indication can be 23 hours plus 59 minutes at maximum.

After the driving time reaches the maximum record value, or when the battery gets disconnected, or the engine flameout condition lasts for 2 hours, the driving time will clear automatically and calculation starts anew.

The displayed fuel range is calculated based on the current fuel consumption and the fuel amount left in the fuel tank. It changes as the driving condition changes. When the fuel level low warning indicator illuminates, "fuel insufficient, add fuel" will appear in the fuel range indication area. If you long press "OK" on the current interface, the driving time will be cleared, while the fuel range cannot be cleared.

Interface 5—Tire Pressure Indication

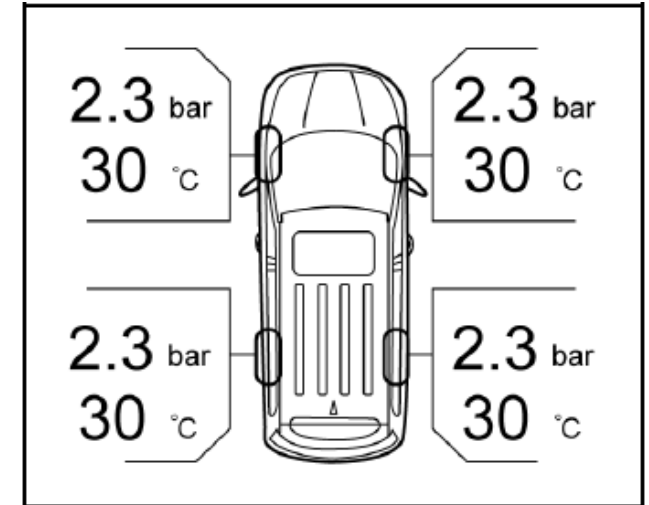

The tire pressure monitor system (TPMS) displays the current pressure and temperature of the four tires respectively.

When the system detects tire pressure low or high, it gives a prompt, asking you to adjust the tire pressure in time. For the standard tire pressures, please refer to "Technical Data".

If the tire temperature value becomes extremely great, for example, when you are driving down a slope and applies the brake frequently, please stop the vehicle to cool down the tires. If the shown tire temperature value becomes abnormal, please contact the Service Center as soon as possible for inspection and repair.

**Note**

Please keep the tire pressure within the reference range, otherwise the tire service life and vehicle controllability can be reduced, or flat tire can happen which is very dangerous. Please do not continue driving if the tire temperature is extremely high. Once overheated, the brake may fail to provide sufficient braking force and the tire may become flat. Please stop the vehicle as soon as possible to cool down the tire and carry out inspection.

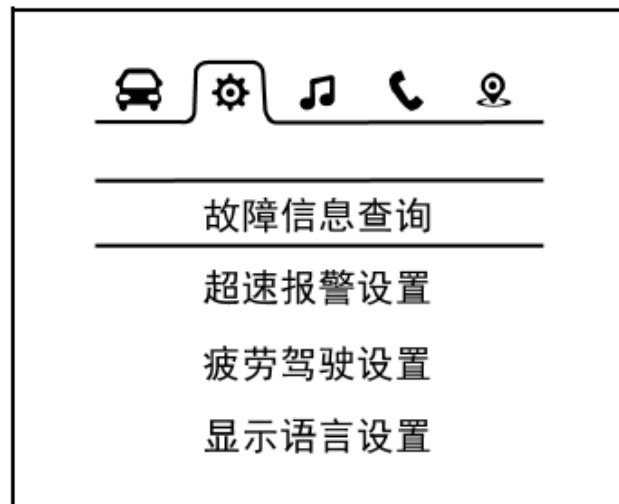
**Vehicle Information Setup Option**

This option allows access to fault information inquiry, overspeed warning setup, fatigue driving setup and display language setup.

Pull the up/down selection button and then press "OK" to enter the interface under this option.

The control button on the steering wheel will be shielded as a warning message pops out on the display screen. The control button will give no response even though it is pressed until the warning message disappears.

**Interface 1—Fault Information Inquiry**

Press "OK" and you will enter the fault information inquiry interface. If no fault information is shown, a prompt saying no fault information exists will appear on the LCD; if any fault information is shown, you can check it one by one by pushing the up/down selection button.

Press "OK" to return to the parent directory.

If any fault exists at the time of vehicle start, a fault warning will appear and last for 5s. Please contact the Service Center for inspection and repair.

When the icon under this option changes to what is shown above, it indicates a vehicle fault to which you should keep alert. Please contact the Service Center in time for inspection and repair so as to eliminate the safety hazard.

**Interface 2—Overspeed Warning Setup**

Enter the overspeed warning setup interface and you can set the overspeed warning speed value. Once the driving speed exceeds the set value, a text warning message will appear on the LCD, accompanied by a sound alarm. The system reminds you that the speed is too high for driving safety in this way. You can also disable the overspeed warning function by selecting the corresponding option on this interface. The overspeed warning function gets disabled by fault once the battery power is cut off.

Set range of overspeed warning: 30 km/h~ 130 km/h at an increment/decrement of 5 km/h.

Interface 3—Fatigue Driving Warning Setup



Enter the fatigue driving function setup interface and you can make fatigue driving function setup. Once the driving time reaches or exceeds the set value, a text warning message will appear on the LCD, accompanied by a sound alarm. The system reminds you to have a rest if necessary in this way. You can also disable the fatigue driving function by selecting the corresponding option on this interface. The fatigue driving function gets disabled by fault once the battery power is cut off.

Set range of fatigue driving warning: 1 h~ 4 h at an increment/decrement of 0.5 h.

Interface 4—Display Language Setup



Enter the display language setup interface and you can set Chinese or English as the current display language.

Multimedia Information Option



Choose this option and the instrument cluster will show AM, FM or audio information real-time on the screen. If the instrument cluster has not connected to the relevant system, "Connecting Multimedia" will appear on the screen.

## Bluetooth Telephone Information Option



Choose this option and the Bluetooth telephone interface will appear. If the instrument cluster has not connected to Bluetooth telephone, "Telephone Not Connected" will appear on the screen. After successful connection, "Telephone Connected" will appear on the screen.

The instrument cluster will show the current state of Bluetooth telephone on the screen: "incoming call", "outgoing call" and "on the line".

In addition, the instrument cluster will also show the current telephone number and name of the contact on the screen.

## Navigation Information Option



Choose this option and the instrument cluster will show "road name", "destination" "distance information" or indication icon on the screen, depending on the current state of the navigation system.

If the instrument cluster has not connected to the navigation system, "Connecting Navigation" will appear on the screen.



**Door Ajar Warning Lamp**

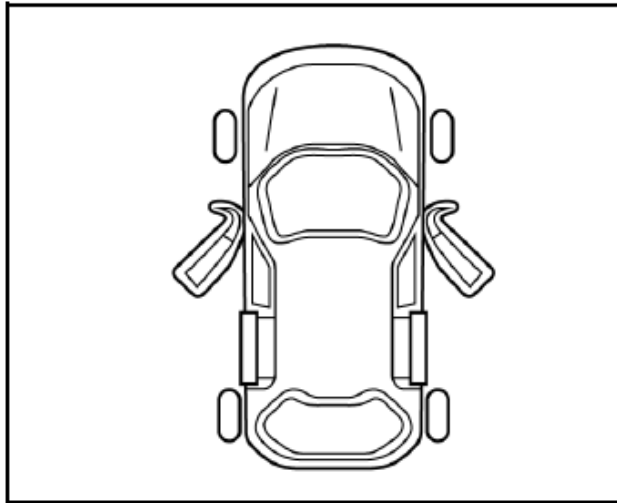

If any door in the front or rear row is ajar or not fully closed, a warning lamp shaped like the door ajar will illuminate; if the liftgate is ajar or not fully closed, a warning lamp shaped like a liftgate ajar will illuminate or flash. If any door is not fully closed while the vehicle is running at a speed of  $\geq 10$  km/h, a door ajar alarm sound will be issued.

**Instrument Cluster Display Brightness Adjustment**  
Type-I Instrument Cluster\*

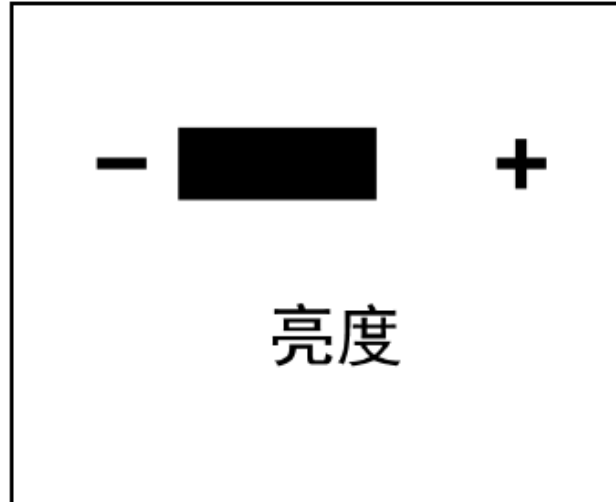

Turn the adjustment lever to set the desired display brightness. After adjustment, if no operation is conducted within 2s, the system will turn back to the previous interface.

**Type-II Instrument Cluster\***

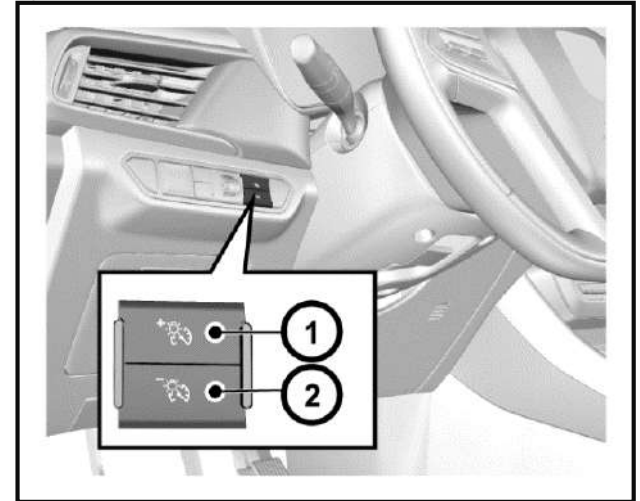

For high-configuration models, a backlight brightness adjustment button is set at the left side of the instrument panel.

Turn the ignition switch to ON position and then press the backlight adjustment button to set backlight brightness of the instrument cluster.

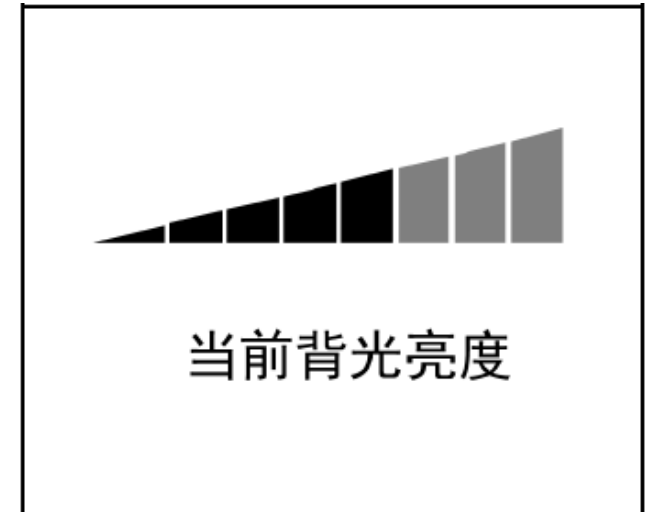

As it is shown in the figure, the current backlight brightness will be shown on the LCD as you make the adjustment. If no operation is conducted within several seconds, the system will save the setup and turn back to the previous interface. When the position lamp is switched on, the backlight brightness will decrease automatically.

### Type-I Trip Computer Display Screen Switch

If the vehicle is equipped with a Type-I trip computer display screen, you can short press or long press the adjustment lever on the instrument cluster to switch the display modes or conduct clearing. As it is shown in the figure:

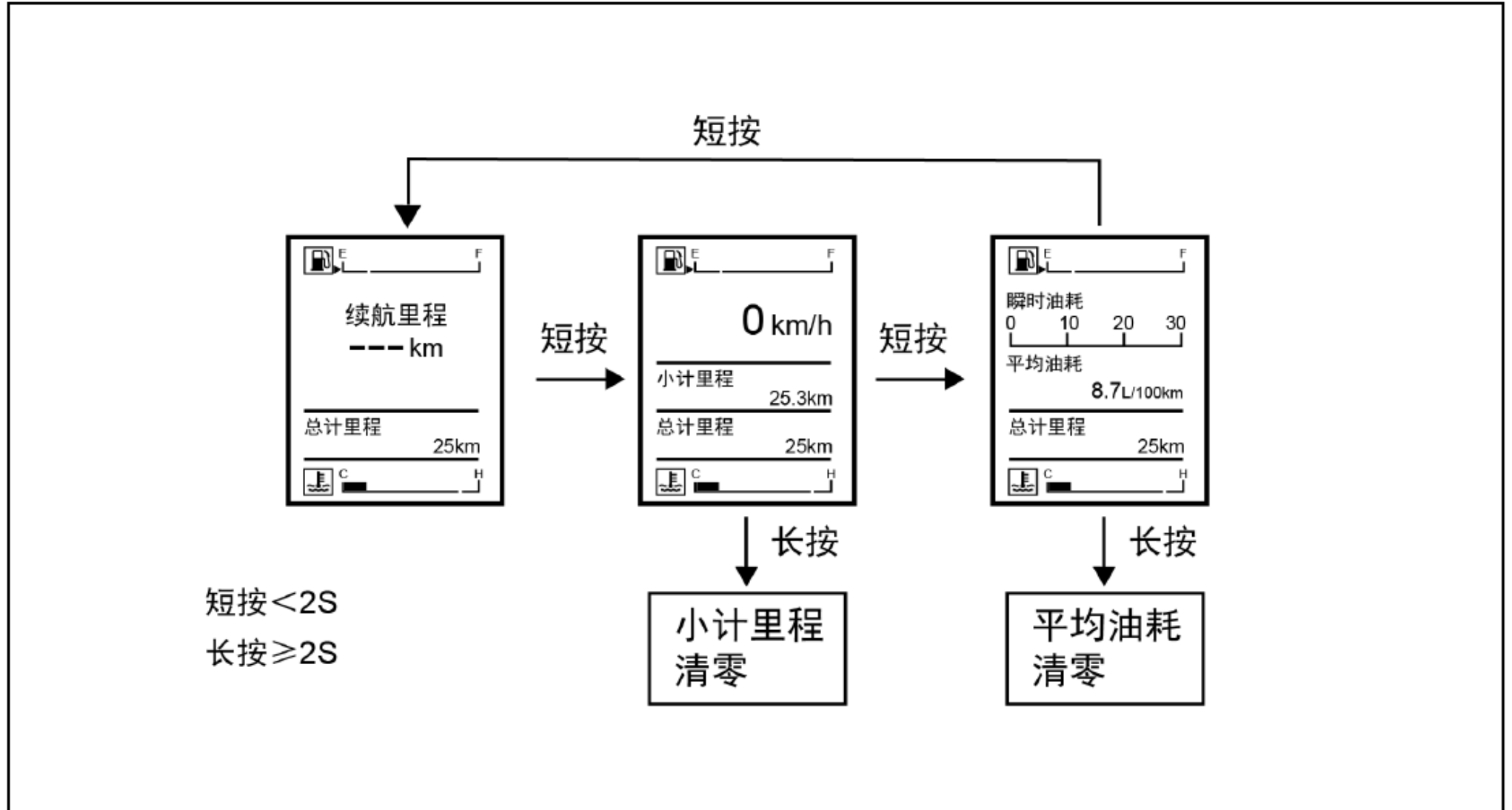

### Control Indicators Type-I Instrument Cluster

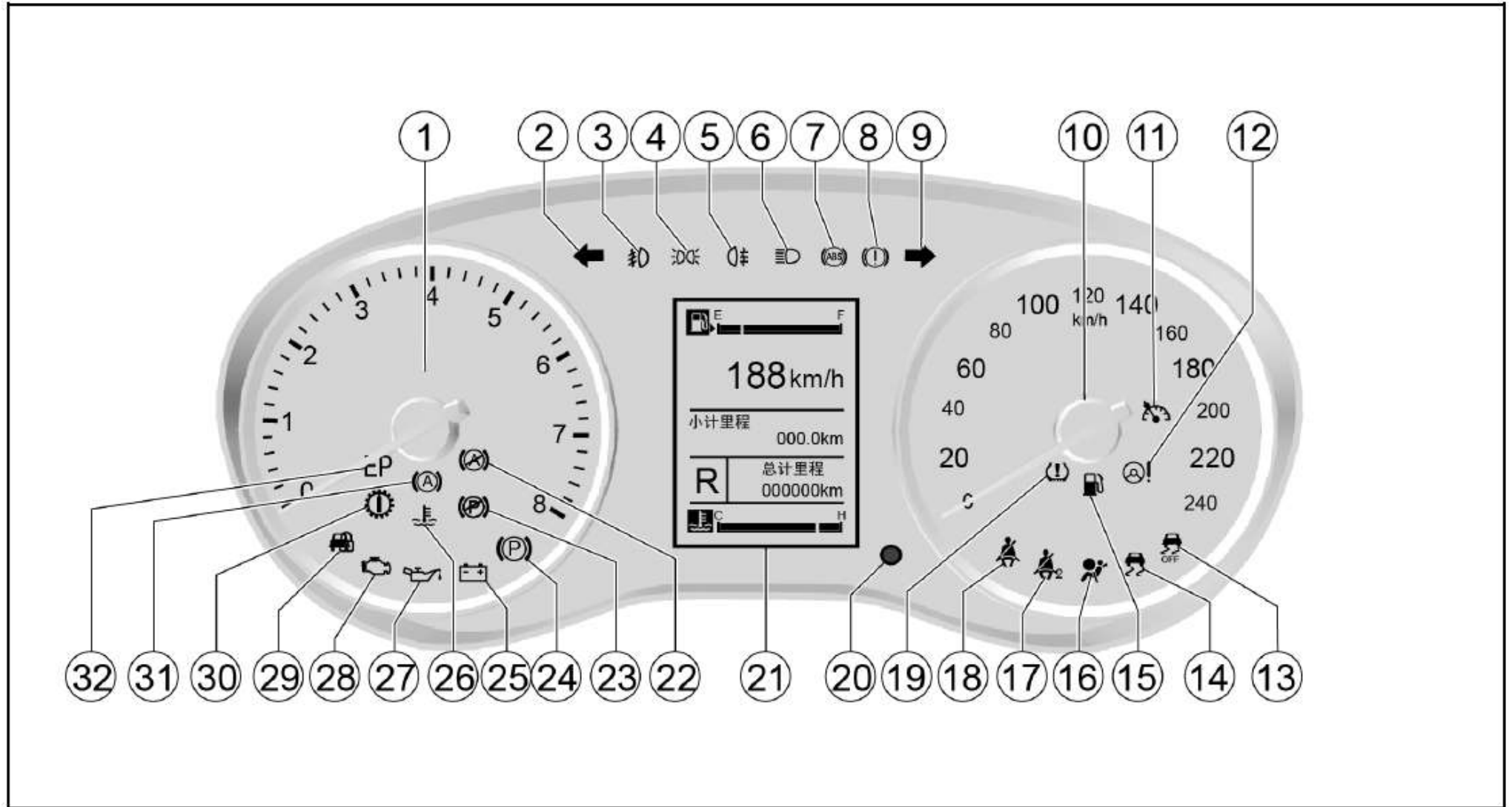

1. Engine tachometer
2. Left turn signal lamp/hazard warning indicator
3. Front fog lamp indicator\*
4. Position lamp indicator
5. Rear fog lamp indicator
6. Headlamp high beam indicator
7. ABS fault warning lamp
8. Brake system/hand brake indicator/EBD warning lamp
9. Right turn signal lamp/hazard warning indicator
10. Speedometer:
11. Cruise control system working condition indicator\*
12. Electronic power steering (EPS) fault warning lamp
13. Electronic stability control (ESC) OFF indicator
14. Electronic stability control (ESC) fault warning lamp
15. Fuel level low warning lamp
16. Airbag fault warning lamp
17. Front passenger fasten-seat-belt warning lamp\*
18. Driver fasten-seat-belt warning lamp
19. Tire pressure monitor system (TPMS) fault warning lamp\*
20. Display adjustment lever
21. Trip computer display screen

25. Charging system fault warning lamp
26. Coolant temperature too high warning lamp
27. Engine oil pressure too low warning lamp
28. Engine malfunction indicator lamp (MIL)
29. Engine immobilizer system indicator
30. Transmission fault warning lamp\*

After the ignition switch is turned on, as a functional test, most of the control indicators will illuminate for a short while.

Colors of the control indicators mean:

Red = danger, important reminder

Yellow = warning, information, fault.

Green = activation confirmed.

Blue = activation confirmed.

Type-II Instrument Cluster

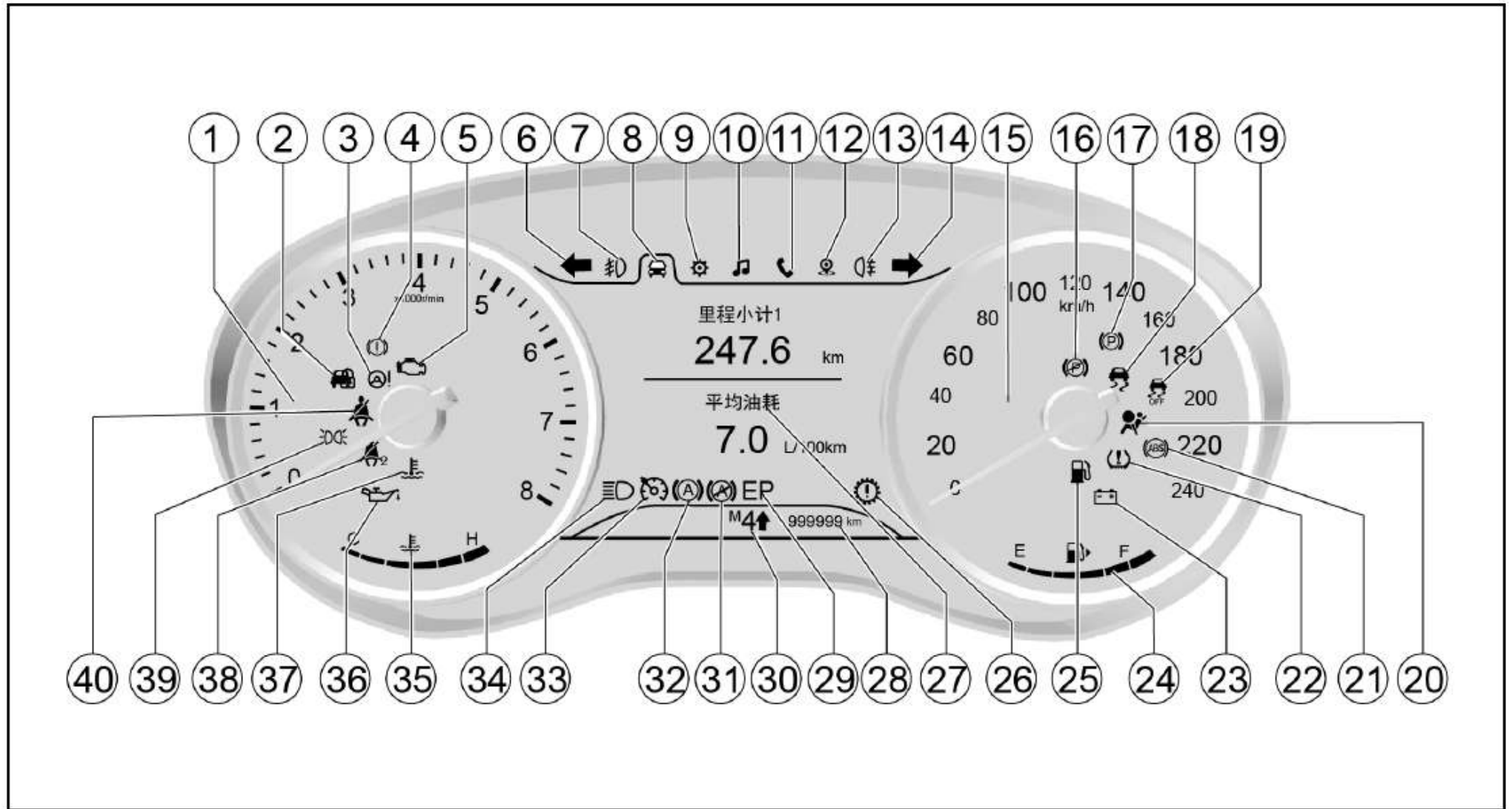

1. Engine tachometer
2. Engine immobilizer system indicator
3. Electronic power steering (EPS) warning lamp
4. Brake system/hand brake indicator/EBD warning lamp
5. Engine malfunction indicator
6. Left turn signal lamp/hazard warning indicator
7. Front fog lamp indicator\*
8. Trip computer information option
9. Vehicle information setup option
10. Multimedia information display option
11. Bluetooth telephone information display option
12. Navigation information display option
13. Rear fog lamp indicator
14. Right turn signal lamp/hazard warning indicator
15. Speedometer:
18. Electronic stability control (ESC) fault warning lamp\*
19. Electronic stability control (ESC) OFF indicator\*
20. Airbag warning lamp
21. ABS warning lamp

22. Tire pressure monitor system (TPMS) fault indicator\*
  23. Charging system warning lamp
  24. Fuel gauge
  25. Fuel level low warning lamp
  26. Transmission fault warning lamp\*
  27. Display
  28. General odometer
  33. Cruise control system working condition indicator\*
  34. Headlamp high beam indicator
  35. Coolant temperature gauge
  36. Engine oil pressure low warning lamp
  37. Coolant temperature too high warning lamp
  38. Front passenger fasten-seat-belt warning lamp
  39. Position lamp indicator
  40. Driver fasten-seat-belt warning lamp
- After the ignition switch is turned on, as a functional test, most of the control indicators will illuminate for a short while.
- Colors of the control indicators mean:
- Red = danger, important reminder

Yellow = warning, information, fault.  
 Green = activation confirmed.  
 Blue = activation confirmed.

### Turn Signal Lamp/Hazard Warning Indicator

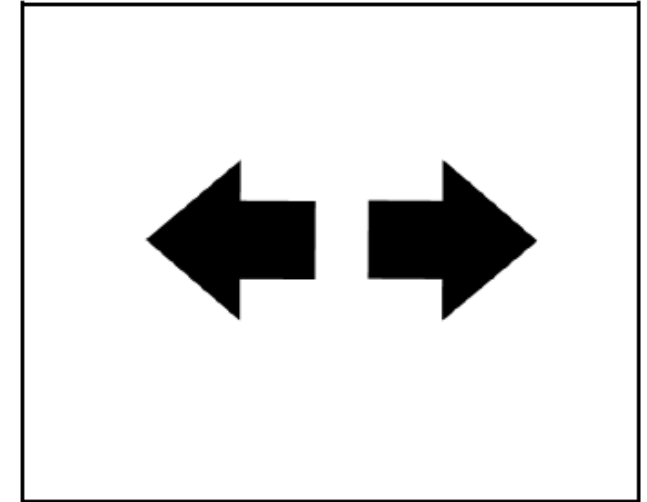

The turn signal lamp/hazard warning lamp indicator is used to confirm whether the outside turn signal lamp/hazard flasher can work normally. If you find that the green arrow does not flash as you send a turning signal or press the hazard warning button, please inspect the fuse and bulb and if necessary, replace them.

**Caution**

These indicators are essential for assurance of driving safety. If the turn signal lamp or the hazard flasher indicator bulb has burnt out, please replace it immediately. If you fail to keep these indicators in an agreeable working condition, accident may happen and as a result, personal injuries, and damage to the vehicle or other properties can occur.

**Note**

If the flashing time is shorter than normal, it indicates that the turn signal lamp bulb has burnt out and must be replaced.

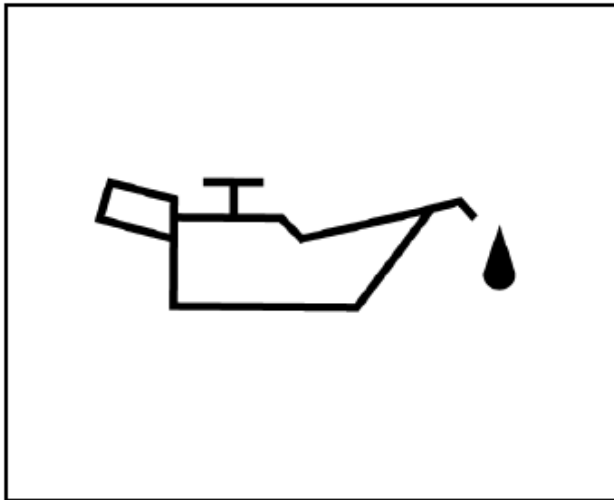
**Engine Oil Pressure Too Low Warning Lamp**

As you turn on the ignition switch, the engine oil pressure too low warning lamp illuminates and it goes out after the engine gets started. This indicates that the indicator bulb can work normally.

If this warning lamp illuminates while the engine is running, it indicates that the engine oil pressure may have dropped to a dangerous level. Please stop the engine and check the oil level immediately.

If the oil level is too low, please add the specified engine oil to the appropriate level. Please refer to the information about engine oil level check provided in "Vehicle Maintenance". If the oil level is normal, please go to the nearest Aftersales Service Center to check the lubrication system.

**Caution**

When the engine oil pressure too low warning lamp illuminates, it indicates that the engine oil pressure may have dropped to a dangerous level. Please do not drive the vehicle when the warning lamp has illuminated. Otherwise, the repair charge will be expensive.

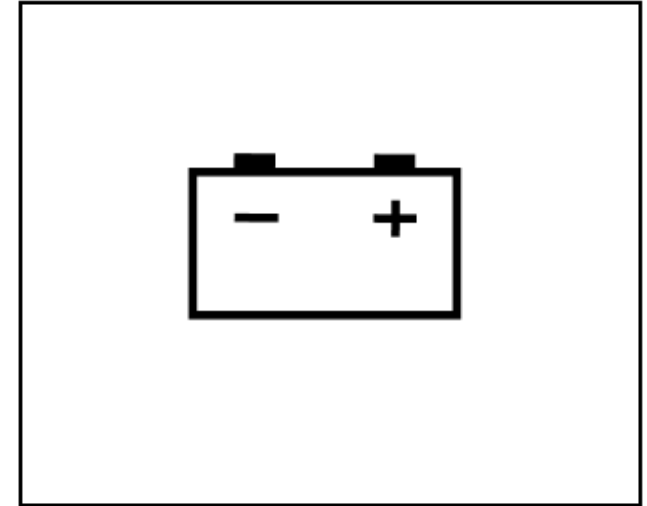
**Charging System Warning Lamp**

This warning lamp illuminates as you turn on the ignition switch. It goes out as the engine gets started. If the charging system warning lamp illuminates during driving:

1. Drive the vehicle off the lane in a safe manner.
2. Stop the vehicle.
3. Check and confirm that the drive belt has not loosened or broken.
4. If the drive belt is normal but the charging system warning lamp keeps illuminated, it can indicate a charging system fault. We advise you to go to the nearest Aftersales Service Center for vehicle repair as soon as possible.



**Note**

If the charging system warning lamp illuminates, it may indicate a charging system fault. Please do not drive the vehicle when the charging system warning lamp has illuminated, otherwise the vehicle can be damaged.

**Note**

If you often drive the vehicle for short trips, the battery capacity consumes more quickly, so it is necessary to replenish the electric energy by charging the battery or having a long trip.

**Coolant Temperature Too High Warning Lamp**

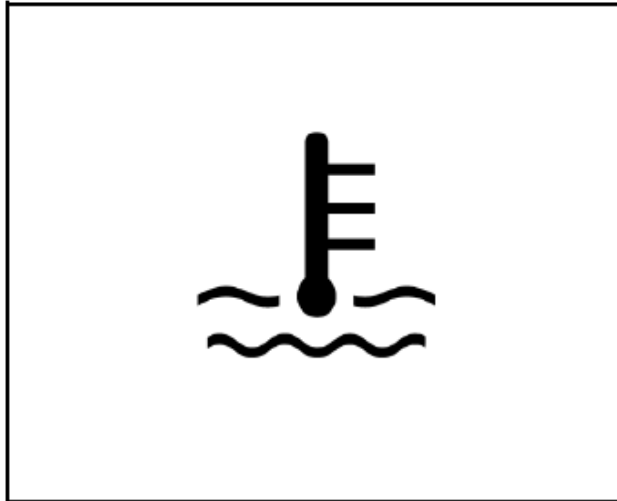

This warning lamp illuminates as you turn on the ignition switch and it goes out several seconds later. It indicates that both the system and the indicator bulb can work normally. This indicator illuminates when the coolant temperature becomes excessively high. It indicates that the engine has over heated. Please do not continue driving the vehicle.

**Front Fog Lamp Indicator\***

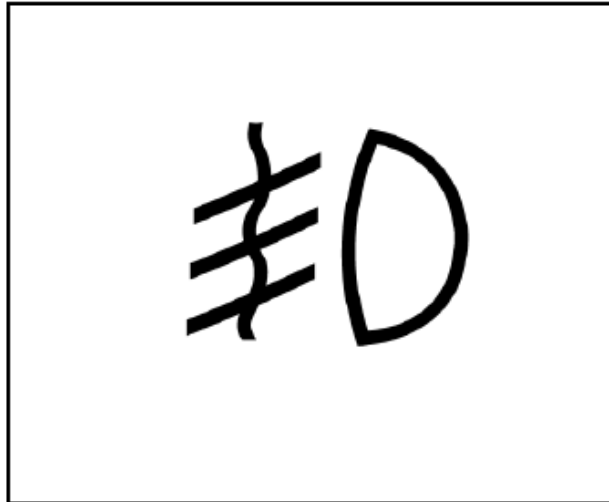

This indicator illuminates when the front fog lamp is turned on. Refer to "Front Fog Lamp" in the lighting section.

**Rear Fog Lamp Indicator**

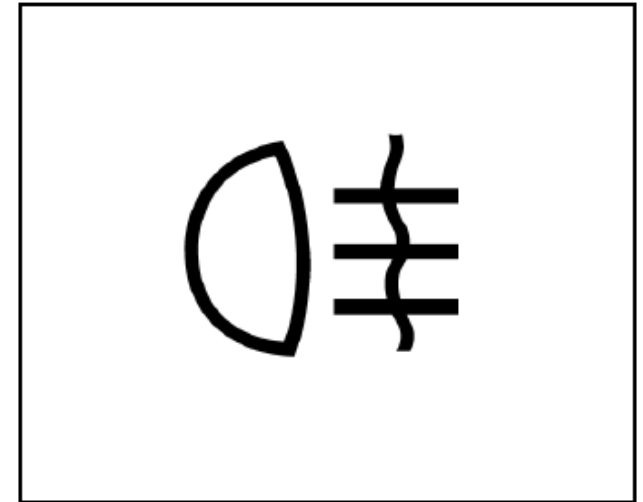

This indicator illuminates when the rear fog lamp is turned on. Refer to "Rear Fog Lamp" in the lighting section.

**Headlamp High Beam Indicator**

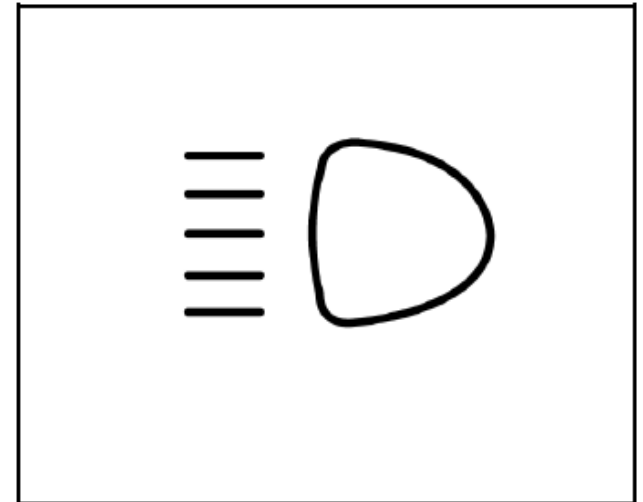

The high beam indicator illuminates when the headlamp high beam is turned on.

**Position Lamp Indicator**

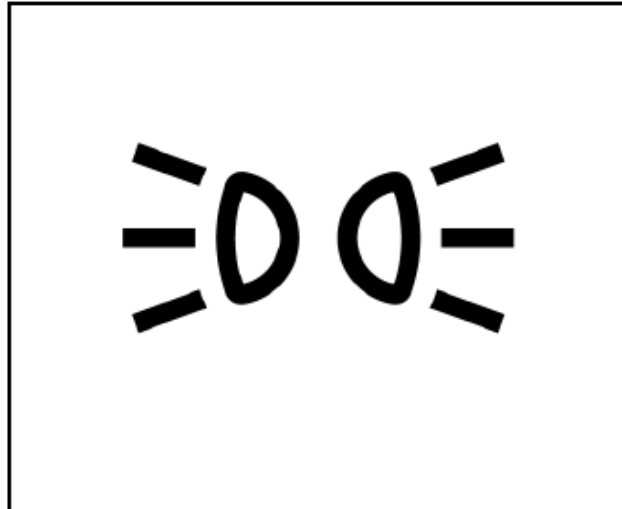

This indicator illuminates when the position lamp is turned on.

**Engine Malfunction Indicator Lamp (MIL)**

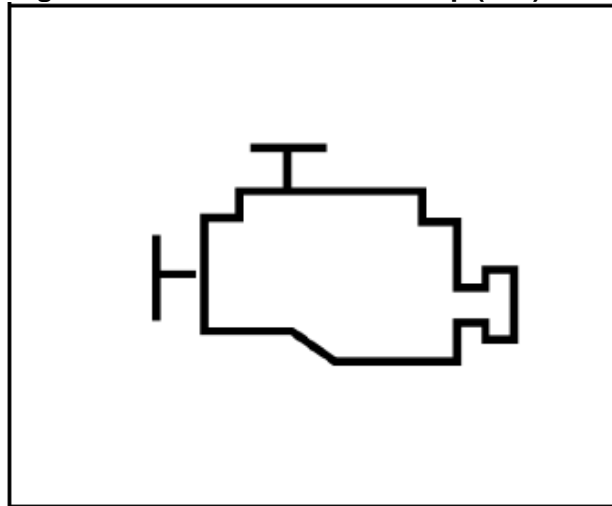

This indicator lamp illuminates when the ignition switch is turned on but the engine has not started. This indicates that the indicator lamp bulb can work normally. The lamp goes out after the engine is started. This malfunction indicator lamp (MIL) illuminates upon occurrence of any component or subsystem fault related to the emission system. Once the electronic control module (ECM) detects any fault, the malfunction indicator lamp will keep illuminated. In case that serious misfire is detected, the malfunction indicator lamp will flash constantly. Serious misfire can cause damage to the catalytic converter. In case of this, the electronic system of the vehicle will switch to an emergency running procedure so that you can continue the trip. However, we advise you to go to the nearest Aftersales Service Center for fault removal as soon as possible. If MIL illuminates for a while and then goes out, it is normal, not indicating any system fault.

**Caution**

If MIL illuminates, it indicates a fault that must be noted. Continuous driving after MIL has illuminated can cause damage to the emission control system, and reduce fuel economy and vehicle controllability. We advise you to go to the nearest Aftersales Service Center for vehicle repair as soon as possible.

**ABS Fault Warning Lamp**

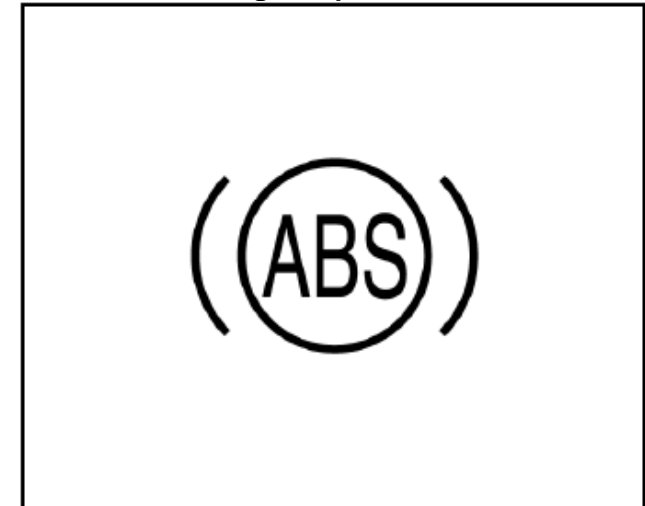

The ABS warning lamp will illuminate immediately the ignition switch is turned on. It indicates that the system is conducting self-inspection and the warning lamp bulb can work normally. The warning lamp goes out several seconds later.

When the ABS warning lamp gets into the following states, please consult the nearest Aftersales Service Center.

- Not illuminated as the ignition switch is turned on

- Always illuminated
- Illuminated during driving

If the ABS warning lamp illuminates during driving, it indicates possibility of an ABS fault. Though the vehicle can run normally without ABS function, but we strongly advise you to go to the nearest Aftersales Service Center for ABS inspection and necessary repair.

#### Caution

Illuminated ABS warning lamp can also indicate that the brake cannot work normally. If you fail to keep the brake in an agreeable working condition, collision may happen and as a result, personal injuries, and damage to the vehicle or other properties can occur.

#### EPS Fault Warning Lamp



This warning lamp will illuminate immediately the ignition switch is turned on. It indicates that the system is conducting self-inspection and the warning lamp bulb can work normally. The warning lamp goes out several seconds later. When the electronic power steering (EPS) system detects a fault, the warning lamp will give out an indication. The vehicle can still steer even the steering system has a fault, but it demands much greater effort. In case of the following circumstances, please consult the nearest Aftersales Service Center.

- The lamp does not illuminate when the ignition switch is turned on.
- The lamp does not go out after it illuminates.
- The lamp illuminates during driving.

#### Caution

Illuminated ABS warning lamp can indicate that the electronic power steering column cannot work normally. If you fail to keep the steering column in an agreeable working condition, collision may happen and as a result, personal injuries, and damage to the vehicle or other properties can occur.

#### Airbag Fault Warning Lamp



The airbag warning lamp illuminates when the ignition switch is turned on and it goes out several seconds later. This indicates that both the warning lamp bulb and the airbag system can work normally.

In case of an airbag fault, the warning lamp will give out indication in any of the following ways:

- The lamp does not illuminate when the ignition switch is turned on.

- The lamp does not go out after it illuminates.
- Flashing or keeping illuminated during driving.

### Caution

**If the airbag warning lamp flashes or keeps illuminated during driving, it indicates an airbag system fault. The airbag system will get deactivated and thus fail to trigger off in case of an accident. We strongly advise you to drive the vehicle to the nearest Aftersales Service Center for inspection. If an accident happens after the airbag system fault has occurred, personal injuries or even death can appear as a result.**

### Brake System/EBD Warning Lamp

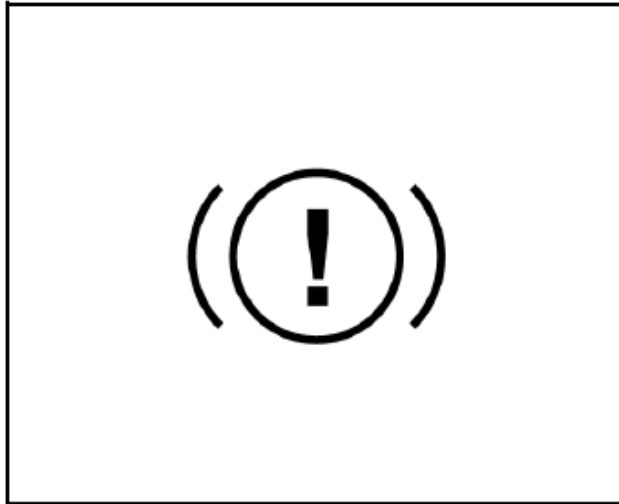

### Model with Mechanical Hand Brake

The brake system warning lamp illuminates after the ignition switch is turned on and it goes out several seconds later (if the parking brake has been released). This indicates that the warning lamp can work normally.

The brake system/EBD warning lamp also illuminates when the parking brake engages. The lamp goes out after the parking brake is released. Please do fully release the parking brake before starting the vehicle.

If the brake system warning lamp illuminates after the parking brake is fully released, it indicates possibility that the brake fluid level in the fluid reservoir is too low or an EBD system fault has occurred.

In case of this, please operate in the following steps:

1. Carefully drive the vehicle off the lane and then stop the vehicle.
2. Check the brake fluid level.
3. Add the recommended brake fluid until the fluid level reaches MAX (highest) mark. Refer to "Adding Brake/Clutch Fluid".
4. In case of the following circumstances, we advise you to drive the vehicle at a safe speed to the nearest Aftersales Service Center to inspect the brake and confirm that:
  - The brake can work normally.
  - You think the brake system is safe at your own judgment.
5. In case of the following circumstances, we advise you to tow the vehicle to the nearest Aftersales Service Center for inspection and repair:

- You discovered brake system leakage.
- The brake system warning lamp keeps illuminated.
- The brake cannot work normally.

### Caution

**Please do not drive the vehicle when the brake system warning lamp has illuminated. This phenomenon indicates possibility of brake failure to work normally. Driving the vehicle after a brake fault has occurred can lead to collision, causing personal injuries and damage to the vehicle or other properties as a result.**

**Caution**

If the brake system warning lamp does not illuminate after the parking brake engages with the ignition switch turned on, please do not drive the vehicle.

Please ensure that light-emitting diode of the warning lamp works normally. If the lamp does not illuminate when the parking brake engages with the ignition switch turned on, even though light-emitting diode of the warning lamp works normally, we still advise you to go to the nearest Aftersales Service Center to inspect the brake system.

These phenomena indicate possibility of a brake system fault.

If you fail to keep the brake in an agreeable working condition, collision may happen and as a result, personal injuries, and damage to the vehicle or other properties can occur.

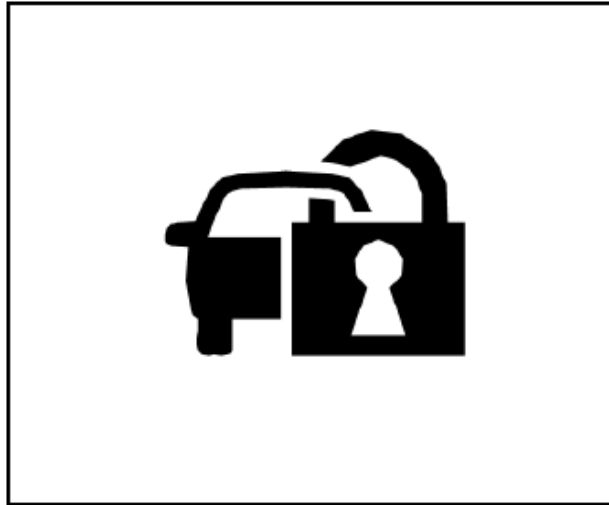
**Engine Immobilizer System Indicator**

This indicator illuminates when the door is opened. It goes out after the engine is started. This indicates that the indicator can work normally. Refer to information on engine immobilizer system given in "Driving and Controls".

**Driver Fasten-Seat-Belt Warning Lamp**

The seat belt warning lamp illuminates if the driver does not fasten the seat belt properly after the ignition switch is turned on. Following this, the following circumstances will appear unless the driver fastens the seat belt properly:

- The seat belt warning lamp keeps illuminated;
- If the vehicle speed exceeds 20 km/h, the warning lamp will flash and the warning buzzer will buzz for a certain time.

**Front Passenger Fasten-Seat-Belt Warning Lamp\***



The seat belt warning lamp illuminates if the front passenger seat is occupied but the occupant does not fasten the seat belt properly after the ignition switch is turned on. Following this, the following circumstances will appear unless the front passenger fastens the seat belt properly:

- The seat belt warning lamp keeps illuminated;
- If the vehicle speed exceeds 20 km/h, the warning lamp will flash and the warning buzzer will buzz for a certain time.

This warning lamp does not illuminate if the front passenger seat is not occupied after the ignition switch is turned on.

**Fuel Level Too Low Warning Lamp**

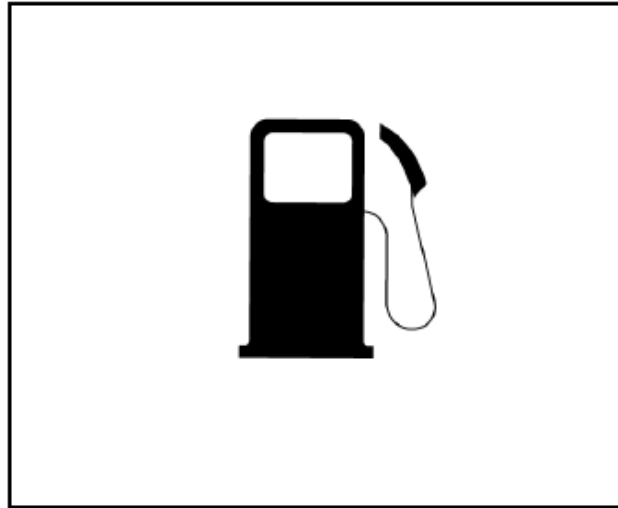

This warning lamp will illuminate immediately the ignition switch is turned on. It indicates that the system is conducting self-inspection and the warning lamp bulb can work normally. If this lamp keeps illuminated after the ignition switch is turned on or it illuminates during driving, it indicates that the fuel amount in the fuel tank is insufficient and you should replenish the fuel in time.

**Note**

**Do not exhaust the fuel, otherwise the catalytic converter can be damaged.**

**Electronic Parking Brake (EPB) Working Indicator\***

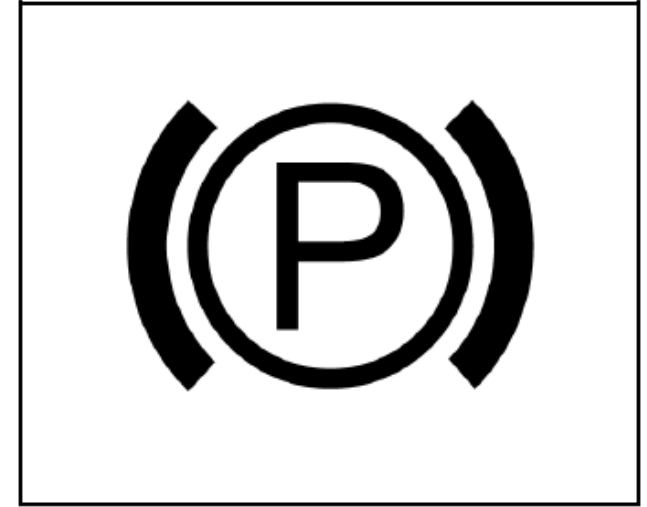

The electronic parking brake (EPB) working indicator illuminates as the electronic parking brake is pulled up. This indicates that the vehicle is in a parking state.

This indicator goes out as the electronic parking brake is released. This indicates that the vehicle is out of the parking state.

This indicator keeps illuminated as long as the electronic parking brake engages firmly.

For details about the electronic parking brake (EPB), please refer to “Parking Brake” under “Driving and Controls”.

### Electronic Parking Brake (EPB) Fault Warning Lamp\*



The electronic parking brake fault warning lamp illuminates after the ignition switch is turned on and it goes out several seconds later. This indicates that both the warning lamp and the electronic parking brake function module can work normally.

In case of an electronic parking brake fault or a warning lamp fault, it will be indicated in any of the following ways:

- The lamp does not illuminate when the ignition switch is turned on.
- The lamp does not go out after it illuminates.
- The lamp illuminates during driving.

Once the electronic parking brake (EPB) fault warning lamp shows the above abnormalities, please contact the Service Center in time. An electronic parking brake fault can cause the vehicle to coast.

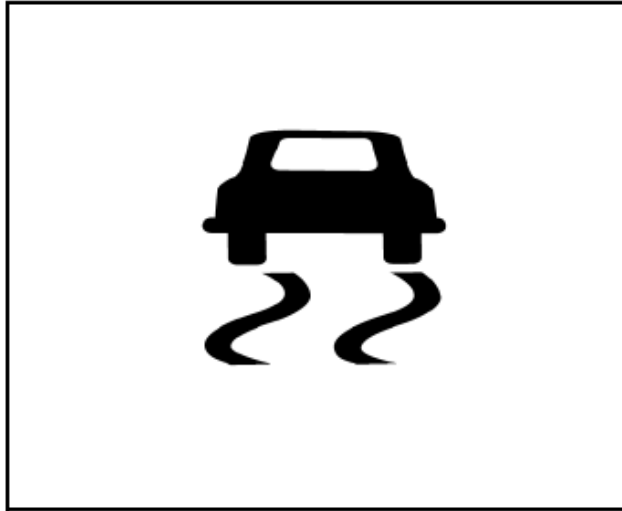
**ESC Fault Warning Lamp**

The warning lamp illuminates after the ignition switch is turned on and it goes out several seconds later. This indicates that the warning lamp can work normally. The ESC lamp flashes once the ESC function is triggered off. The system informs the driver that ESC is working in this way. If the ESC lamp keeps illuminated, it indicates an ESC fault. Please refer to information given in “Electronic Stability Control (ESC)” under “Driving and Controls”.

**ESC OFF Indicator**

The warning lamp illuminates after the ignition switch is turned on and it goes out several seconds later. This indicates that the warning lamp can work normally. If you press “ESC OFF” switch when the vehicle speed has not exceeded the threshold value, certain functions of ESC will be deactivated. At this time, ESC OFF indicator illuminates. Please refer to information given in “Electronic Stability Control (ESC)” under “Driving and Controls”.

**Note**

**Generally, it is not advised to turn ESC OFF switch off.**

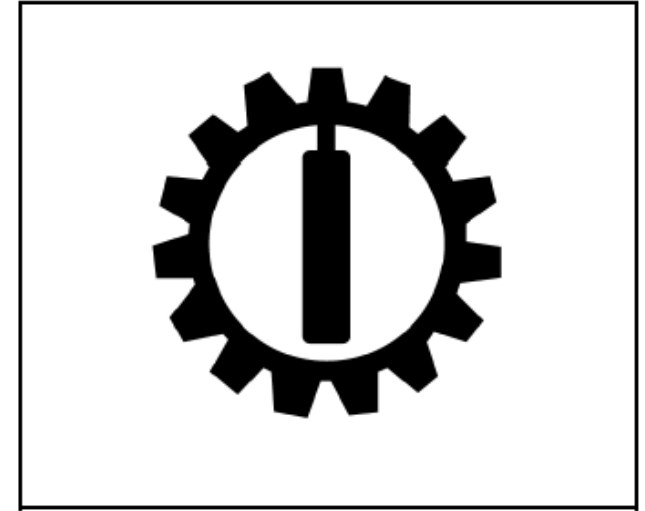
**Transmission Fault Warning Lamp\***

The transmission fault warning lamp illuminates when the ignition switch is turned on and it goes out several seconds later. This indicates that both the warning lamp bulb control system can work normally. For certain vehicle models, the warning lamp does not illuminate when the ignition switch is turned on. It only illuminates upon fault occurrence.

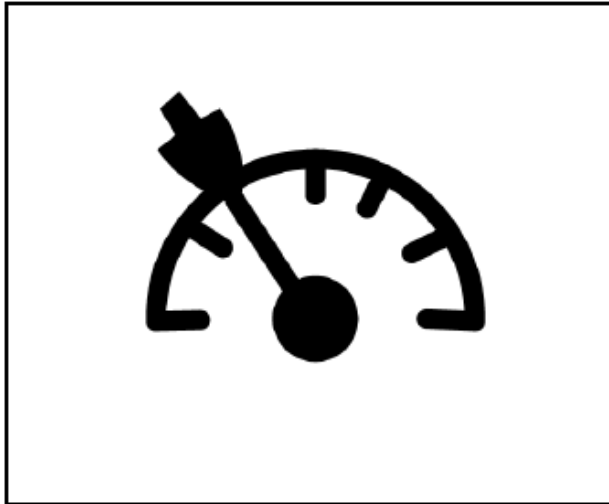

**Cruise Control System Working Condition Indicator\***

This indicator illuminates when the cruise control function is activated. Refer to information given in "Cruise Control System" under "Driving and Controls".

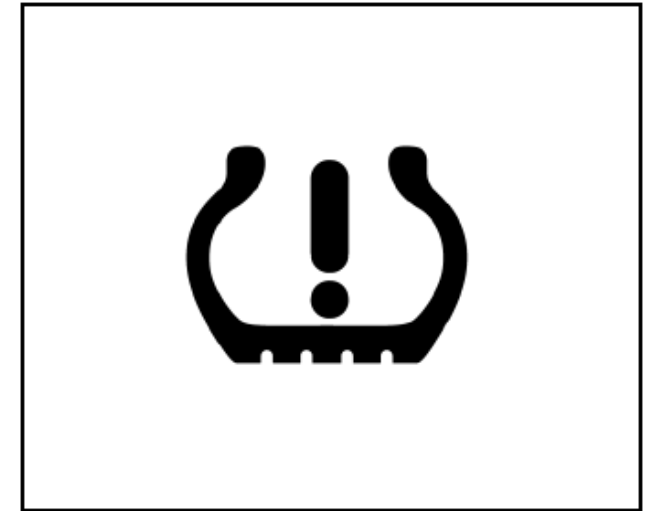
**TPMS Fault Indicator\***

The warning lamp illuminates after the ignition switch is turned on and it goes out several seconds later. This indicates that the warning lamp can work normally. The TPMS fault indicator illuminates when the tire pressure is too low or too high, or when a TPMS fault occurs. For the correct tire pressures, please refer to "Technical Data".

**Reverse Sensor\***

The intelligent reverse sensor judges the distance between rear end of the vehicle and the obstacle via the ultrasonic transducer installed on the rear bumper.

If the buzzer buzzes once after you turn on the ignition switch and shift to reverse gear, it indicates that the system can work normally.

If the buzzer buzzes twice, it indicates that one transducer fails to work; if it buzzes thrice, it indicates that 2 or more transducers cannot work normally.

The intelligent reverse sensor starts to work immediately every time you turn on the ignition switch and shift to reverse gear.

When the distance between the vehicle and the obstacle behind it is within about 1.5 m~1.0 m, the reverse buzzer sends out alarm sound at long intervals.

When the distance between the vehicle and the obstacle behind it is within about 1.0 m~0.6 m, the reverse buzzer sends out alarm sound at short intervals.

When the distance between the vehicle and the obstacle behind it is within about 0.6 m~0.4 m, the reverse buzzer sends out alarm sound at shorter intervals.

When the distance between the vehicle and the obstacle behind it is within about 0.4 m, the reverse buzzer sends out alarm sound constantly.

**Note**

- To ensure reversing safety and to leave enough time for the system to detect, please drive at a speed of 5 km/h or lower during reversing.
- Please stop the vehicle immediately a constant alarm sound is heard in case that the vehicle bumps onto the obstacle behind it.
- Please do not knock the transducers hard or wash them directly with a high-pressure water gun, otherwise the transducers can be damaged.
- Sundries on the transducers such as snow, mud and water drops can lead to misoperation.
- Please note that the system is likely to fail to detect the following obstacles: those of a conical shape or acute angle reflectors; objects which are prone to absorb sound wave, such as cotton and snow; fine objects such as iron gauze and ropes; objects 30 cm or lower to the ground or 1 m or higher than the ground. The system may detect these obstacles first, but as they become nearer and nearer to the vehicle, they can get out of the effective detection range, not detected as a result.
- When reversing down or up a slope, the system may give out a wrong warning, reminding you to take great care.

**Note**

- Please note that the system is likely to work abnormally due to wrong induction under the following circumstances: reversing the vehicle on an uneven road, a road paved with round stones, an uphill road or grassland; interference from ultrasonic noise, metallic sound or high-pressure gas emission sound of the same frequency; sundries on the transducers; height change of vehicle rear end under heavy load; other detecting equipment installed within the effective detection range.
- If any nonstandard radio communication equipment is installed on the vehicle, usage of such equipment (not including mobile cellphone and audio system) may affect the function of this system.

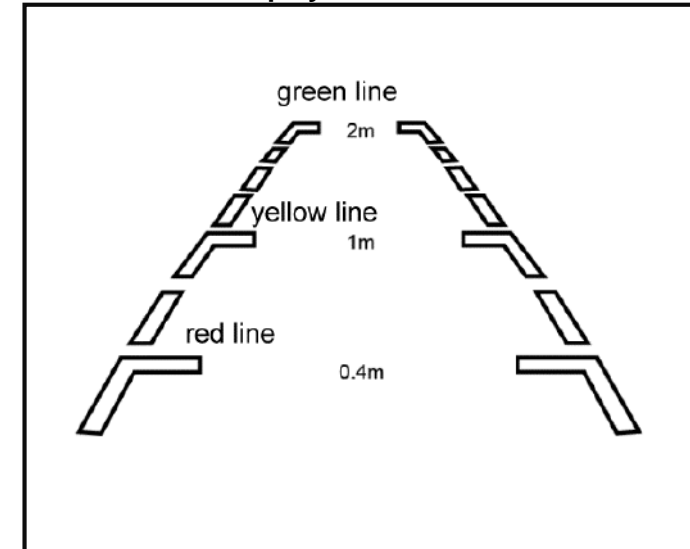
**Reverse Video Display\***

As is shown in the figure, if the vehicle is equipped with reverse camera, images behind the vehicle, reverse auxiliary lines and guide lines will appear on the multimedia player screen after you turn on the ignition switch, release the parking brake and shift to reverse gear "R". If the vehicle is of high configuration, a sector indication area will also show on the screen.

#### Reverse Auxiliary Line

The auxiliary is divided into three sections: red, yellow and green, based on the distance between the object and rear end of the vehicle.

The bottom red line represents the warning line for a distance from the obstacle to the vehicle rear end within 0.4 m; the middle yellow line represents the warning line for a distance from the obstacle to the vehicle rear end within 1.0 m; the top green line represents the warning line for a distance the obstacle to the vehicle rear end within 2.0 m; the line on both sides is the vehicle width indication line.

#### Reverse Guide Line\*

The yellow guide line can develop into a dynamic virtual guiding line as you turn the steering wheel.

#### Sector Indication Area\*

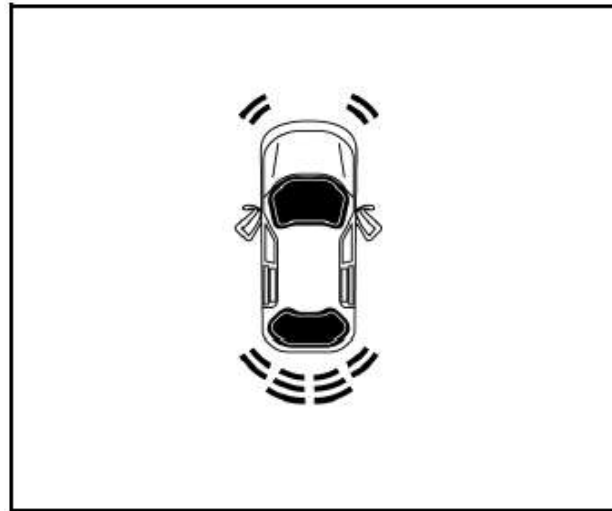

As is shown in the figure, a total of 6 sector indication areas are shown on the screen, indicating the distance from the obstacle to front left, front right, rear left, rear right, rear left middle and rear right middle of the vehicle respectively.

For the front left, front right, rear left and rear right sector indication areas:

When the distance from the vehicle to the obstacle is within about 0.4 m~0.6 m, the sector indication area appears yellow and the buzzer sends out alarm sound at short intervals. When the distance is within 0.4 m, the sector indication area appears red and the buzzer sends out alarm sound constantly.

For the rear left middle and rear right middle sector indication areas: When the distance from the vehicle to the obstacle is within about 0.6 m~1.0 m, the sector indication area appears green and the buzzer sends out alarm sound intermittently. When the distance is within 0.4 m~0.6 m, the sector indication area appears yellow and the buzzer sends out alarm sound at short intervals. When the distance is within 0.4 m, the sector indication area appears red and the buzzer sends out alarm sound constantly.

#### Caution

The intelligent reverse camera can only help the driver avoid accident during reversing. The driver should always keep concentrated. **SGMW** shoulders no responsibility for any personal injury or vehicle damage resulting from careless driving with great reliance on the on-board reverse camera. Before reversing, please ensure that no child or animal is near the vehicle.

### Parking Assist System\*

The parking assist system judges the distance between front/rear end of the vehicle and the obstacle via the ultrasonic transducer installed on the front/rear bumper. If the buzzer buzzes once after you turn on the ignition switch, it indicates that the system can work normally.

If the buzzer buzzes twice, it indicates that one transducer fails to work; if it buzzes thrice, it indicates that 2 or more transducers cannot work normally.

When a transducer fault is detected, the fault information will appear on the audio system display screen.

#### Parking Assist System Switch\*



If the vehicle is equipped with parking assist system switch, the switch indicator will illuminate after the ignition switch is turned on and the parking assist system switch is pressed; if the parking brake is released at this time, the parking assist system starts to work.

If front/rear end of the vehicle is within certain distance from the obstacle, parking assist indication will appear on the audio system display screen. Press the switch again and the parking assist system turns off. The switch indicator also goes out.

The parking assist system activates automatically (under the precondition that the parking brake is released) as the shift lever is turned to the reverse gear.

It exits when the vehicle speed exceeds 15 km/h. To activate the system again, please press the switch.

#### Parking System Display\*

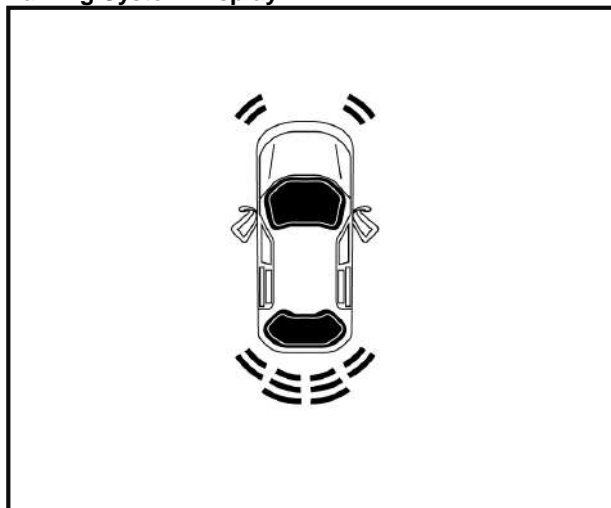

As is shown in the figure, when the transmission is engaged on the forward or the neutral gear, a prompt window will pop up in the audio system display screen as front end of the vehicle is within about 0.6 m from the obstacle or rear end of the vehicle is within about 1.5 m from the obstacle.

Color of the front and rear sector areas will change as the distance changes, accompanied by alarm sound. Please refer to information given in "Sector Indication Area".

The prompt window will disappear when the system detects no obstacle.

The window will disappear immediately you press the window off button (x). It will appear again if an obstacle is detected.

#### Caution

**The reverse camera and the parking assist system can only help the driver avoid accident during reversing or parking. The driver should always keep concentrated. SGMW shoulders no responsibility for any personal injury or vehicle damage resulting from careless driving with great reliance on the on-board radar system. Before reversing or parking, please ensure that no child or animal is near the vehicle as the radar system may fail to respond to them.**

## Lighting

Outside Lighting .....	86
Lighting Switches .....	86
High Beam .....	86
Headlamp Flashing .....	86
Hazard Flasher .....	86
Turn and Lane Change Signal Lamp .....	87
Front Fog Lamp* .....	87
Rear Fog Lamp .....	88
Backup Lamp .....	88
Stop Lamp .....	88
Day Running Lamp* .....	88
Headlamp Leveling .....	88
Headlamp OFF Delay .....	88
Lamp ON Reminder .....	88
Inside Lighting .....	89
Front Reading Lamp .....	89
Rear Reading Lamp .....	90
Luggage Compartment Illumination Lamp .....	90

## Outside Lighting Lighting Switches



To switch on or off the headlamp, tail lamp and parking lamp, please turn the end of the combination switch control lever.

The lighting switch has 3 positions and they represent different lighting functions:

OFF= All the lamps are turned off.

= The position lamp, license plate lamp, instrument panel lamp and backlight of all the panels illuminate.

= The low beam lamp and all lamps mentioned above illuminate under the precondition that the ignition switch is turned to ON position.

## High Beam

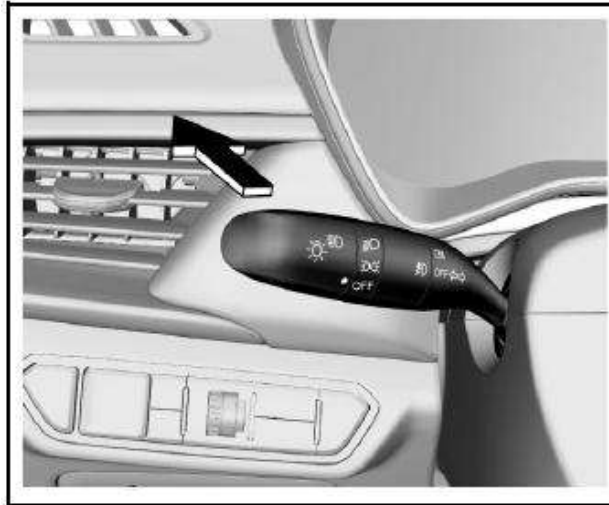

To turn on headlamp high beam:

- Ensure that the ignition switch is in ON position;
- The headlamp is in a low beam state;
- As is shown in the figure, push the combination switch control lever towards the instrument panel.

The headlamp high beam indicator illuminates when the headlamp high beam is turned on. To switch from headlamp high beam to low beam, pull the control lever towards the opposite direction until it returns to the normal position.

<b>Warning</b>
When approaching the on-coming vehicle or the vehicle ahead, please do switch the high beam to low beam. This is because headlamp high beam can make other drivers feel temporarily blind and cause collision as a result.

## Headlamp Flashing

To activate headlamp high beam flashing, please pull the combination switch control lever toward yourself and then release it. The control lever will return to the normal position as you release it.

Before you release the control lever, the headlamp high beam keeps illuminated.

## Hazard Flasher

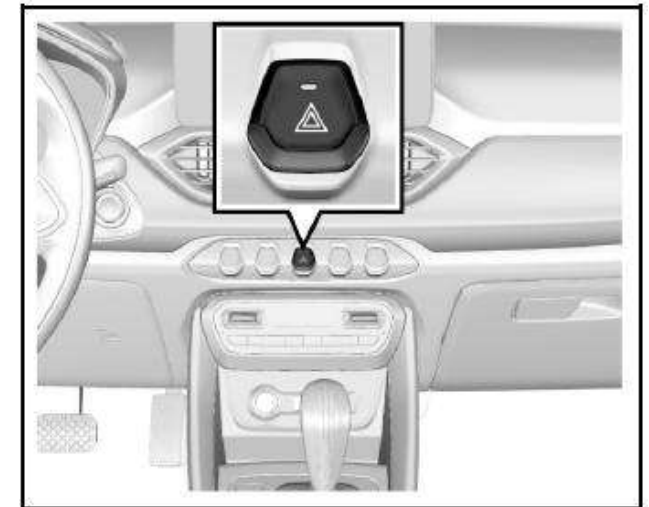

Press  to turn on/off the hazard flasher.

### Turn and Lane Change Signal Lamp

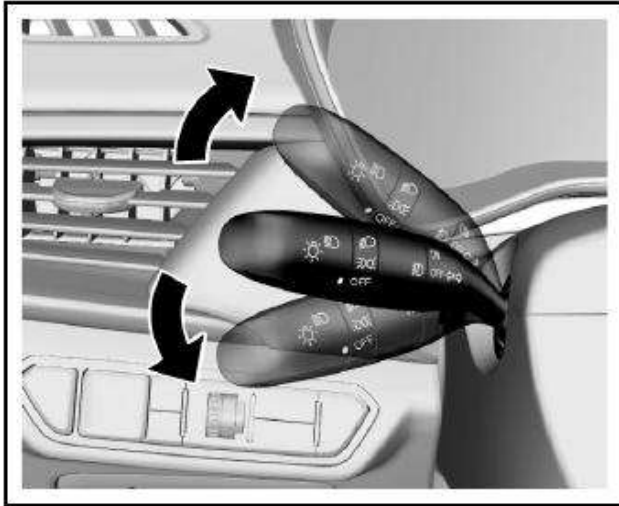

To turn on the turn and lane change signal lamp, the ignition switch must be in ON position.

Control lever upward = right turn signal lamp

Control lever downward = left turn signal lamp

After cornering, the turn signal interrupts automatically and the control lever returns to the normal position.

To change the lane, you can pull the control lever to halfway position (not reaching the turn signal lamp position) and keep pulling it. After lane change, release the control lever and it will return to the normal position automatically.

A rear turn signal lamp is integrated on the rear combination lamp and the rear bumper of your vehicle respectively. If you turn on the turn signal lamp with the liftgate open, the turn signal lamp on the rear bumper will illuminate. This ensures that a turn signal is sent to the drivers behind even when the liftgate is open.

### Steering Assist Lighting Function\*

During steering, the two front fog lamp will illuminate to provide auxiliary lighting if certain conditions are satisfied.

These conditions are:

1. The engine is running;
2. The vehicle speed is  $\leq 35$  Km/h;
3. The low beam lamp is turned on;
4. The steering wheel angle is  $>60^\circ$  or the turn signal lamp switch is turned on.

As the front fog lamp illuminates, the front fog lamp indicator on the instrument panel also illuminates.

The steering assist lighting function deactivates and the front fog lamps go out after a while under any of the following condition:

1. The steering wheel angle is  $\leq 30^\circ$  or the turn signal lamp switch is turned off.
2. The ignition switch is turned to a position other than ON.
3. The vehicle speed is  $> 40$  Km/h;
4. The low beam lamp is turned off.

### Front Fog Lamp\*



When the ignition switch is turned to ON position, and the headlamp functions as a position lamp or in a low beam state, turn the ring button in the middle of the combination switch to ON (connected) position to turn on the front fog lamp. Turn the ring switch to OFF (disconnected) position to turn off the front fog lamp.

### Rear Fog Lamp

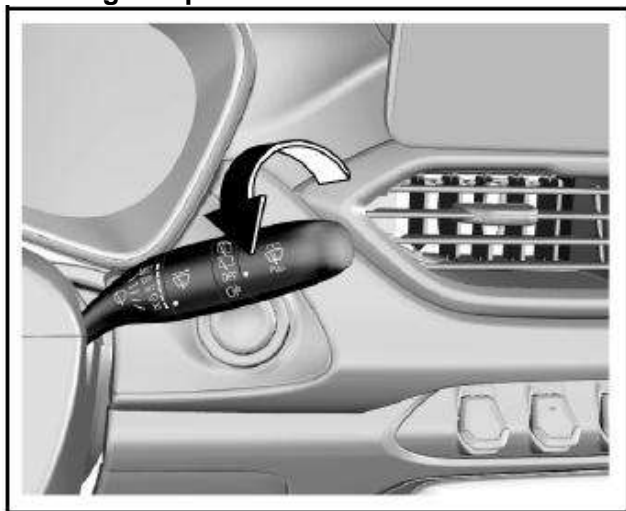

When the headlamp is in low beam state or the front fog lamp is turned on, turn the rear wiper control knob to “s” position and then release it to turn on the rear fog lamp. Turn the knob again to turn off the rear fog lamp.

If the low beam lamp or front fog lamp is turned off with the rear fog lamp turned on, the rear fog lamp keeps on.

### Backup Lamp

The backup lamp illuminates after you turn on the ignition switch and shift to reverse gear.

### Stop Lamp

The stop lamp illuminates as you depress the brake pedal.

### Day Running Lamp\*

The day running lamp turns on automatically as the engine starts; it goes out automatically as the position lamp is turned on.

### Headlamp Leveling

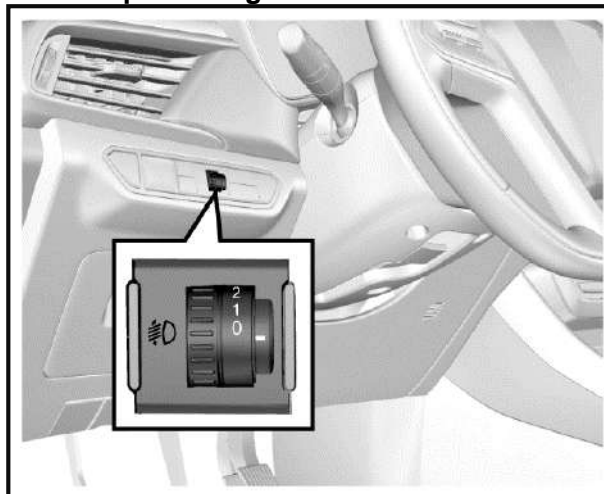

The headlamp leveling knob is located at the left side of the instrument panel.

Please adapt the headlamp illuminate range to the vehicle load so as to acquire the best lighting effect and avoid dazzling. Turn the knob to the desired position:

- 0 = front seats occupied
- 1 = all seats occupied
- 2 = all seats occupied with the luggage compartment loaded
- 3 = driver's seat occupied with the luggage compartment loaded

### Headlamp OFF Delay

To trigger off headlamp OFF delay function, turn off the headlamp and pull the light control lever towards the steering wheel within one second for twice after you shut down the engine and turn the ignition switch to ACC or LOCK position, or after you pull out the key. After remote locking, the low beam lamp will turn off automatically 30s later; if the vehicle is not remotely locked, the low beam lamp will turn off automatically 10 minutes later.

### Lamp ON Reminder

If any lamp switch is not turned to OFF position after you turn the ignition switch to LOCK position or pull out the key, the buzzer will send out alarm sound as the driver's door is opened. The alarm sound stops after the lamp is turned off.



**Inside Lighting**  
**Front Reading Lamp**  
**Type-I**

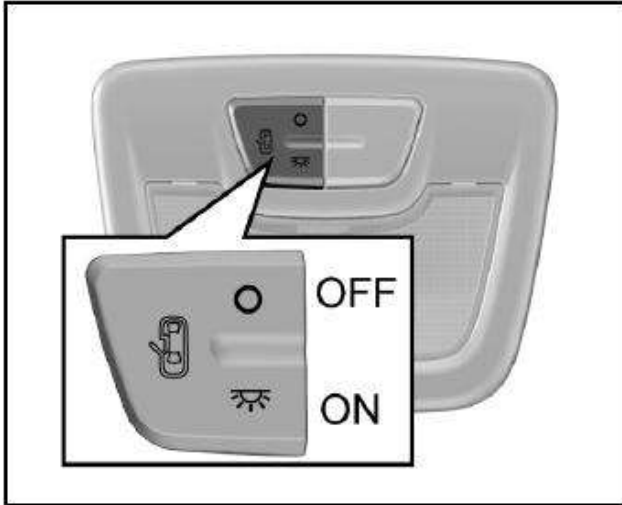

The lamp has 3 working positions.

: The lamp illuminates and keeps illuminated until it is manually turned off.

: The lamp gradually illuminates as any door is opened; it works for a while and then gradually goes out after all the doors (including liftgate) are closed.

: The lamp does not illuminate even a door is opened.

**Type-II**



ON: The lamp illuminates and keeps illuminated until it is manually turned off.

(Intermediate position): The lamp illuminates as the door (including the liftgate) is opened; it gradually goes out after all the doors are closed.

OFF: The lamp does not illuminate even a door is opened.

**Type-III**



or : Press the button to turn on the left/right reading lamp and press it again to turn the lamp off.

: The reading lamp gradually illuminates if any door is opened (including liftgate) as the button is pressed. It gradually goes out after all the doors are closed.

**Warning**

**Please avoid usage of the inside lamps during driving in darkness. A bright passenger compartment can reduce the visibility outside and cause collision as a result.**

### Rear Reading Lamp

#### Type-I



The rear reading lamp has 2 working buttons:

: Press the switch and the lamp illuminates. It will not go out until the switch is pressed again.

: The lamp gradually illuminates if the switch is pressed and any door is opened; it works for a while and then gradually goes out after all the doors (including liftgate) are closed.

#### Type-II

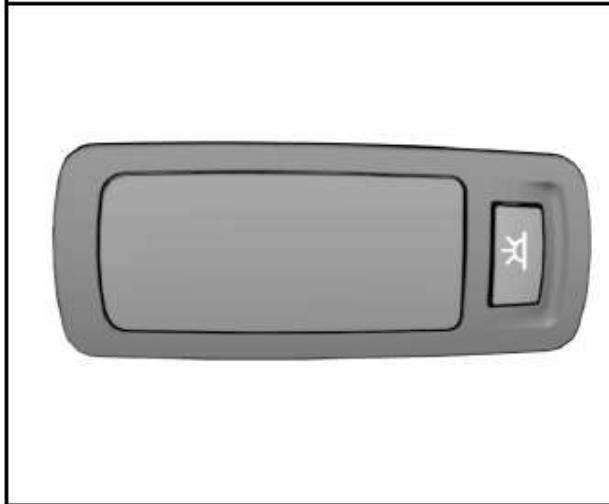

For certain models, two reading lamps are installed on the roof over the second row seats. You can press the reading lamp switch to turn it on/off.

### Luggage Compartment Illumination Lamp

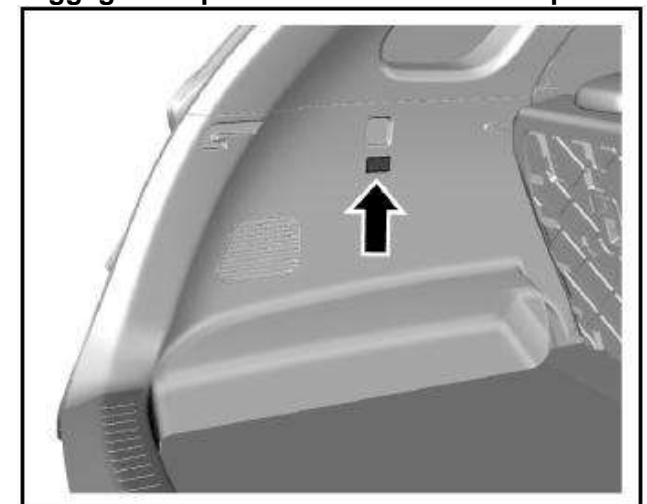

The luggage compartment illumination lamp illuminates as the liftgate is opened. It goes out after the liftgate is closed.

#### Note

**Please do not replace with a high-power bulb (for example, refit with a xenon headlamp) in case that the lamp burns out or an accident arises from it.  
Please turn off all lamps before you leave the vehicle.**

## Driver Information and Entertainment

Audio Control Buttons on Steering Wheel* .....	92
Driver Information and Entertainment.....	93
Navigator Upgrading* .....	94

## Audio Control Buttons on Steering Wheel\*

Type-I

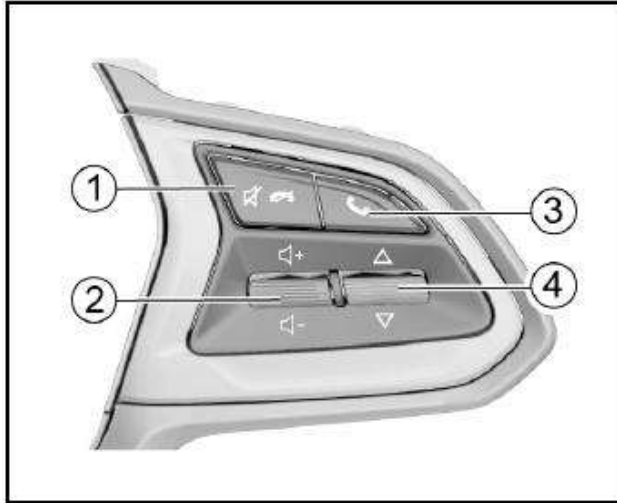

### 1. Mute or Call Hangup Button

It is used to sound off or hang up a Bluetooth telephone call.

### 2. Volume Adjustment Thumbwheel

Pull the thumbwheel up and down to adjust the sound volume.

### 3. Bluetooth Setup or Call Answer Button

Press the button to enter the Bluetooth interface or answer the Bluetooth telephone call.

### 4. Song Selection/Station Switch Thumbwheel

Pull the thumbwheel up and down to select the station or song.

Type-II

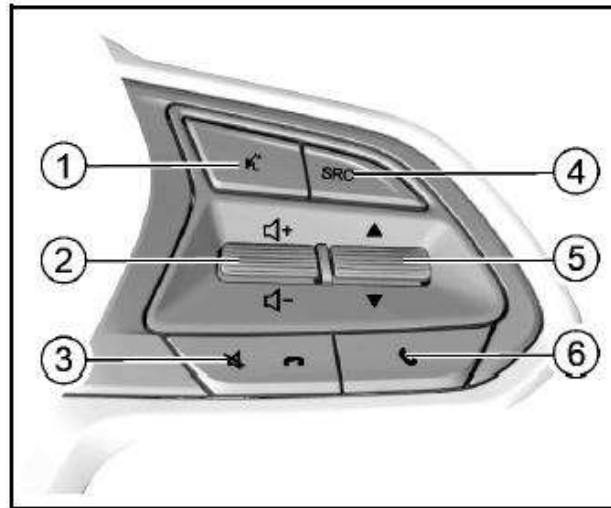

### 1. Reserved Button

It is reserved with no role to play for the time being.

### 2. Volume Adjustment Thumbwheel

Pull the thumbwheel up and down to adjust the sound volume.

### 3. Mute or Call Hangup Button

It is used to sound off or hang up a Bluetooth telephone call.

### 4. Sound Source Selection Button

Press the button to switch among audio sources such as radio/USB/Bluetooth music.

### 5. Song Selection/Station Switch Thumbwheel

Pull the thumbwheel up and down to select the station or song.

### 6. Call Answer Button

Press the button to answer Bluetooth phone calls or enter the Bluetooth interface.

## Driver Information and Entertainment

As the model configuration or the supporting manufacturers are different, the audio entertainment system function, the display interface and the operation method may be different, such as video and entertainment, navigation, reverse camera, Bluetooth and telephone calls. For details about functional introduction and description of the audio entertainment system, please refer to the *Vehicle Audio System Instructions* placed in the glove box.

### Inspection before Repair

If you feel a bit of misgiving about certain audio function, before driving the vehicle to the Service Center for repair, please first read the directions given in the product instructions carefully and then check and operate according to the following table. This can help you remove the fault.

Symptom	Possible Causes and Solution
The host does not work and no information is shown on the screen.	Take out the host from the instrument panel, and then check the host fuse and connector to the vehicle.
The host works but no sound can be heard or the sound volume is very low.	Increase the sound volume and check the front/rear and left/right balance setup of the horn.
The device body is a little hot.	The device heats normally as it works.
The radio cannot search for the desired station.	Inspect whether the antenna is fully stretched and connected correctly. Inspect whether the antenna amplifier in the vehicle has been damaged. Signal of the desired station is too weak and please tune manually.
Certain audio files cannot be played via USB connection.	Please confirm whether the device supports such audio files. Refer to the vehicle audio system instructions.
The sound volume fluctuates as MP3 songs are played.	As MP3 songs are of wide sources and no uniform standard applies. The reason can be that the volumes of MP3 songs are different as they are compressed. Please turn the volume knob to adjust in case of this.
The singer/track/song name cannot be displayed.	The device does not support text display of the audio file.
The music pauses intermittently as it is played.	The reason can be that the format of the music file is different as it is compressed.

Songs stored in the memory device cannot be read.	Please confirm that the storage partition form of the memorizer is FAT16 or FAT32 as it is checked in the computer; if not, please make new setup on the computer to change the format into a standard applicable to the device requirement.
MP3 songs cannot be read via an all-in-one USB adapter.	This device only supports song reading via an adapter with only one USB port.
Noise can be heard.	The noise can be produced by the device used to record the original audio file or it may be the noise existed at the time of recording. Please use other players to play the file and then confirm whether the problem lies in this device.
<b>If the fault still cannot be removed, please go to the Aftersales Service Center for inspection. Never disassemble the host to repair it on yourself.</b>	

### Navigator Upgrading\*

When the navigator cannot display comparatively new main roads, it is time to update and upgrade the map data.

For details, please refer to the navigation system instructions.

<b>Note</b>
-------------

<b>After upgrading, the map may still fail to display all the roads which are recently completed and open to traffic. It is normal that certain roads can be displayed only on an upgraded map of a followup version.</b>
---

## HVAC

Air Outlet .....	96
Air Conditioning .....	98
Electronic Air Conditioning .....	98
Temperature Control Thumbwheel .....	100
Fan Control Thumbwheel.....	100
Air Distribution Mode Button .....	100
Internal Circulation Mode Button.....	102
Front Windshield Defroster Button .....	102
Rear Windshield Defroster Button.....	102
Manual Air Conditioning.....	104
Air Conditioning System.....	106
Air Conditioning (A/C) Button.....	107
Cool Air .....	107
Warm Air.....	107
Ventilation .....	108
Rapid Defrosting and Defogging.....	108

### Air Outlet

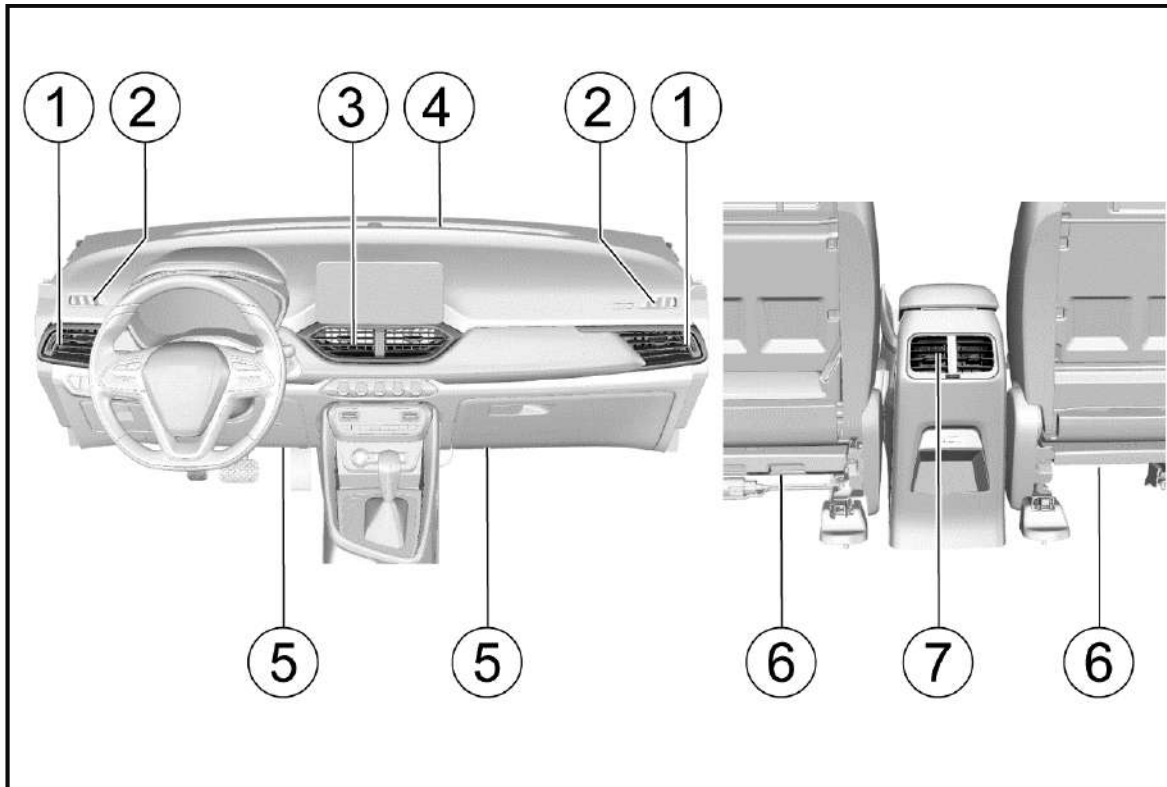

- 1. Side air outlet
- 2. Front door window defogger air outlet
- 3. Central air outlet
- 4. Front windshield defogger air outlet
- 5. Floor air outlet
- 6. Front seat lower air outlet
- 7. Console air outlet\*



**Side Air Outlet**

You can divert the air to both sides of the front riding area or the side door windows by operating the two adjustable side air outlets. Beside each air outlet, an air volume adjustment switch is located and you can operate the switch to adjust the air volume.

**Front Door Window Defogger Air Outlet**

The front door window defogger air outlet is used to divert the air to the side door window, mainly to the outside rearview mirror area.

**Central Air Outlet**

You can decide the flow direction of the air from the two adjustable central air outlets.

**Front Windshield Defogger Air Outlet**

The front windshield defogger air outlet is used to divert air to the front windshield.

**Floor Air Outlet**

The floor air outlet is used to divert the air to the front foot area.

**Front Seat Lower Air Outlet**

Air from the two front seat lower air outlets flows to the rear foot area. Lower of the front seats shall be clear without obstacles in case that air to the rear compartment is blocked.

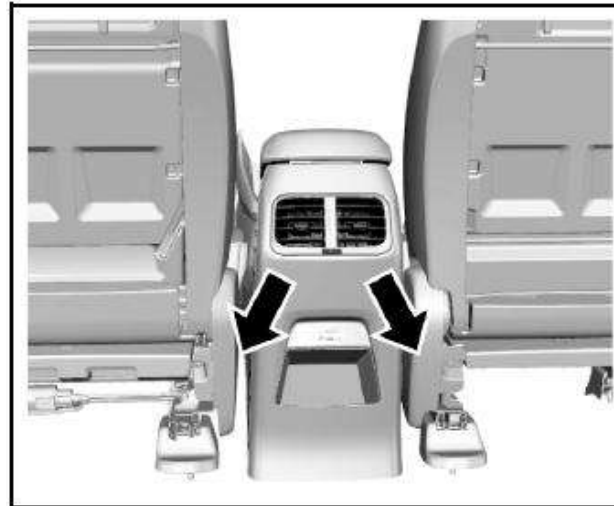
**Console Air Outlet\***

If equipped, the air outlets are located on the back of the armrest between the two front seats. They can divert the air to the rear passenger area.

**Air Conditioning**  
**Electronic Air Conditioning**  
**Air Conditioning Control Panel**

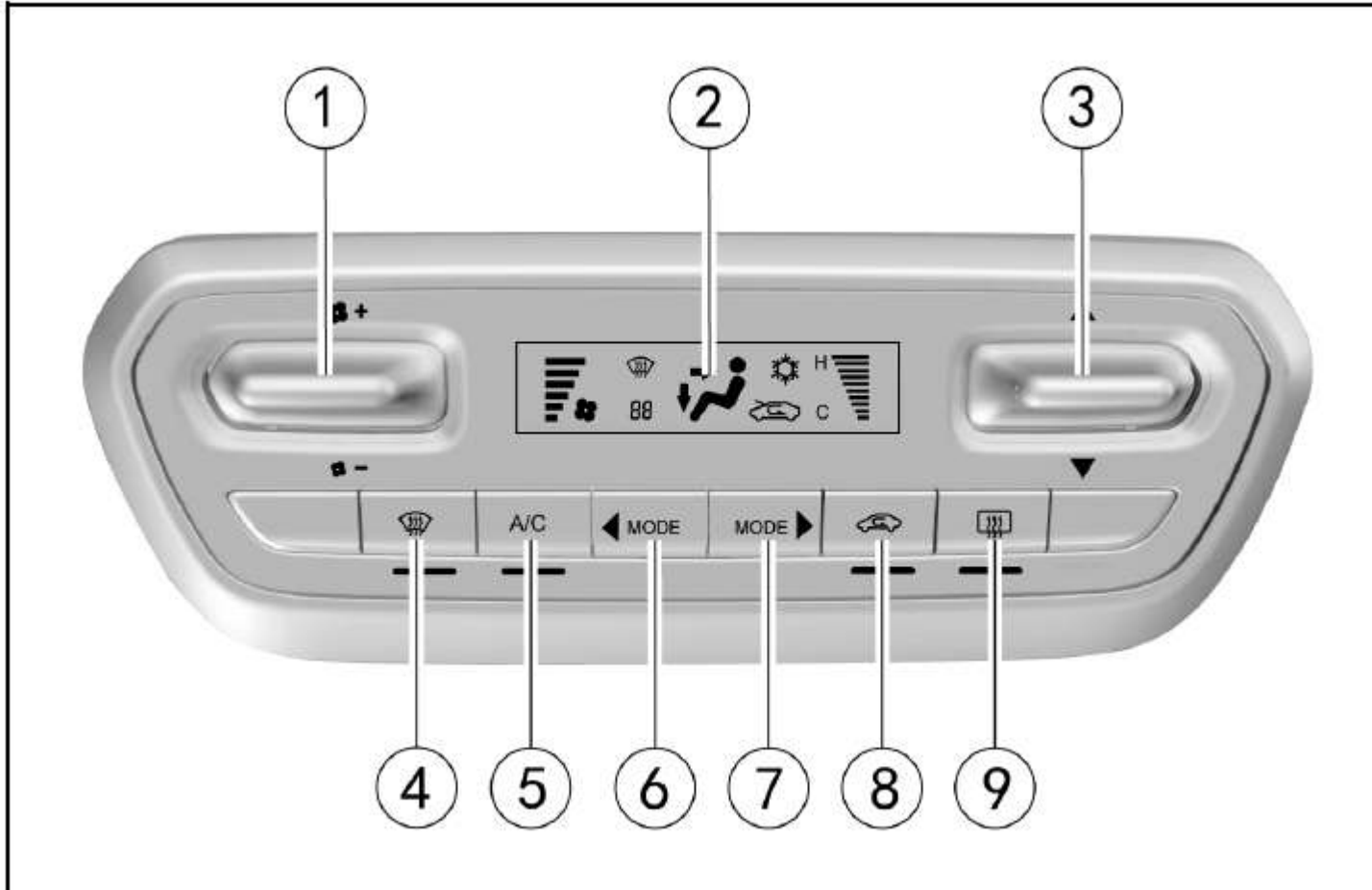

1. Fan control thumbwheel
  2. Display
  3. Temperature control thumbwheel
  4. Front windshield defroster button
  5. Air conditioning (A/C) button
  6. Mode selection button (backward)
  7. Mode selection button (forward)
  8. Internal circulation button
  9. Rear windshield defroster button/outside rearview mirror defroster button\*
- Note: Once the indicator below the button illuminates, the corresponding function starts to work.

Display

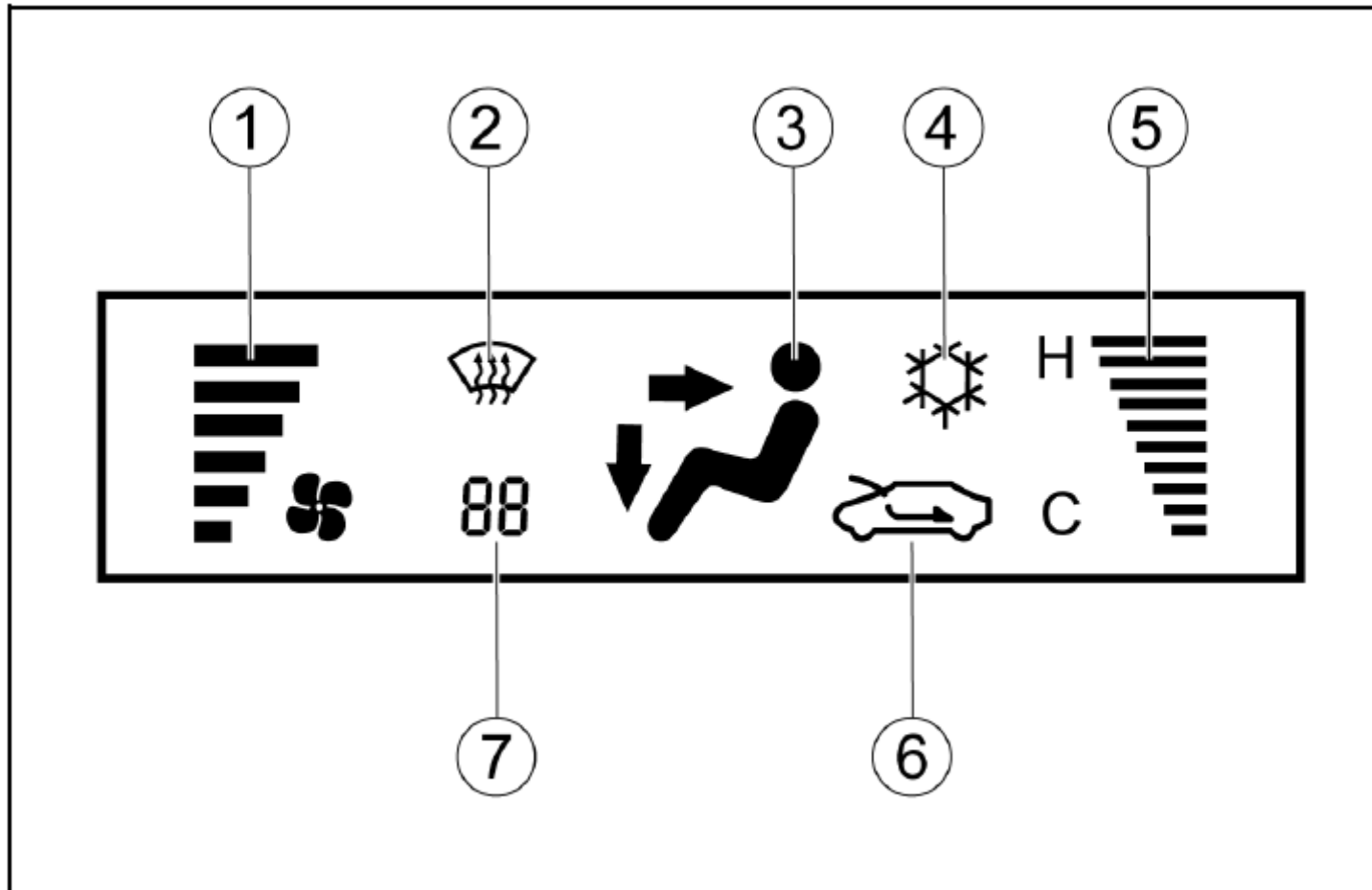

- 1. Air volume
- 2. Front defrosting mode
- 3. Mode display (face blow, face blow/foot blow, foot blow, foot blow/defroster, etc.)
- 4. Cooling mode
- 5. Temperature
- 6. Internal/external circulation mode
- 7. Fault code\*

### Temperature Control Thumbwheel

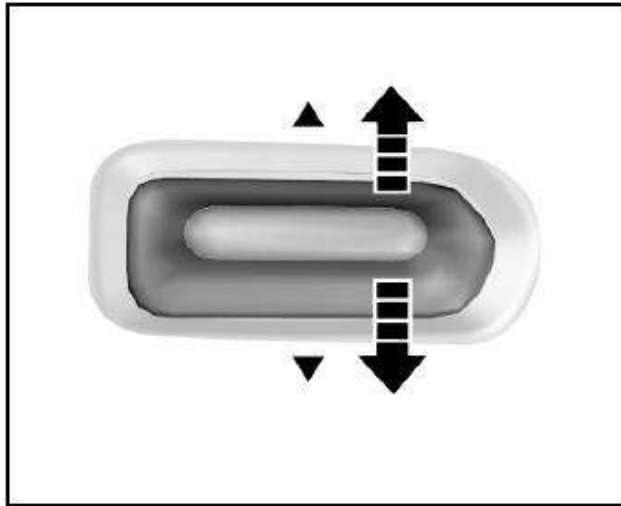

With the air volume switch is turned on, pull it upwards/downwards to increase or decrease the temperature. The temperature display bar on the display screen displays the temperature accordingly. "H" represents hot and "C" represents cool. Once the temperature reaches the hottest (coolest) extent, if you pull the switch up again, the temperature stays unchanged. If you pull the temperature switch after the air conditioning system has been turned off, the system starts again and the start condition is shown on the display screen. At this time, the air volume is set at Range 1 and other states restore to the setups made before the system is turned off.

### Fan Control Thumbwheel

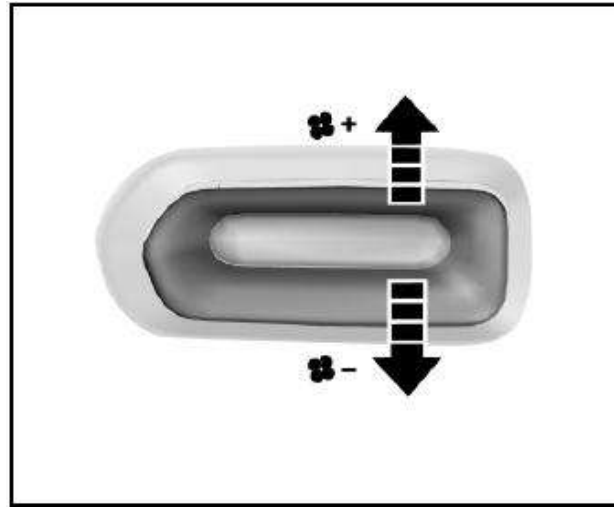

Pull the thumbwheel upwards or downwards once to increase or reduce the air volume by one range. The air volume indication bar on the display screen displays the corresponding range. if the air volume is at Range 1, pull the thumbwheel downwards once to turn off the air conditioning system. If you pull upwards the fan switch after the air conditioning system has been turned off, the air conditioning system starts again and the start condition is shown on the display screen. At this time, the air volume is set at Range 1 and other states restore to the setups made before the system is turned off.

### Air Distribution Mode Button

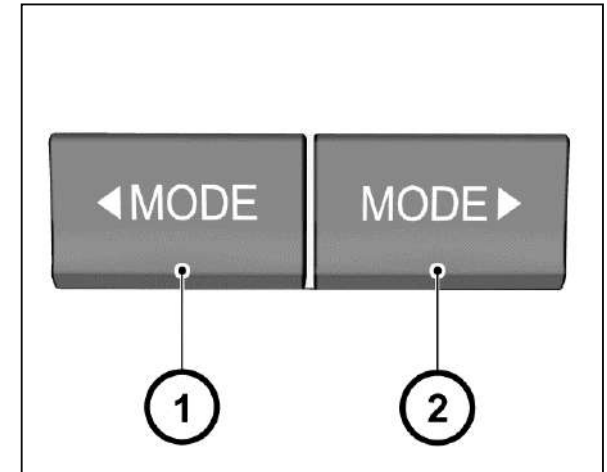

Press the mode selection button to acquire the desired air flow direction. You can set one of the four following air flow directions by pressing the air distribution mode button:

**Face Mode (🌀)**

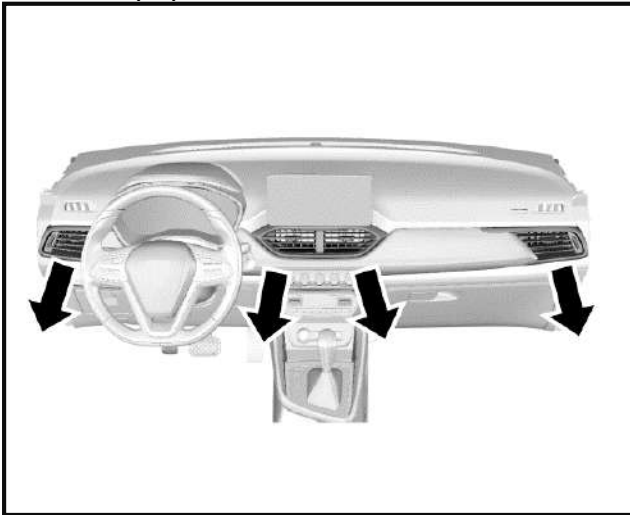

In this mode, the air flows out from the central air outlet, the side air outlet and the console air outlet\*.

**Dual Mode (🌀)**

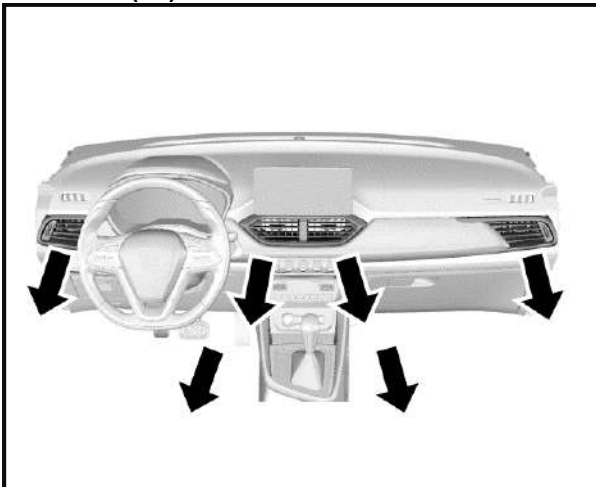

In this mode, the air flows in two directions. Half of the air flows out from the floor air outlet and the front seat lower air outlet; the remaining air flows out from the central air outlet, side air outlet and console air outlet\*.

**Foot Mode (🌀)**

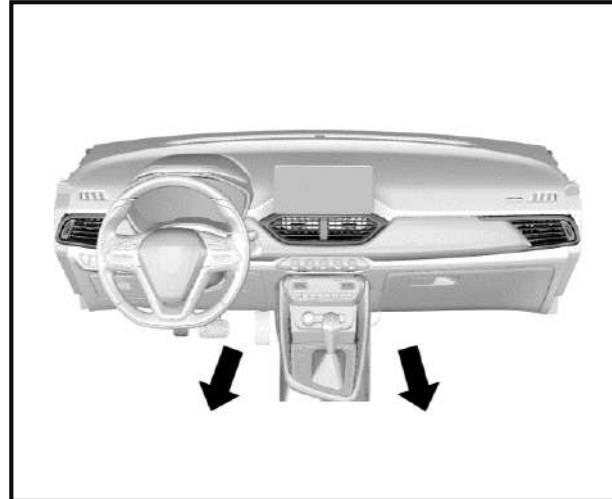

Most of the air flows out from the floor air outlet and the front seat lower air outlet; little amount of air flows out from the windshield and front door window defroster air outlet and the side air outlet.

**Foot/Defroster Mode (🌀)**

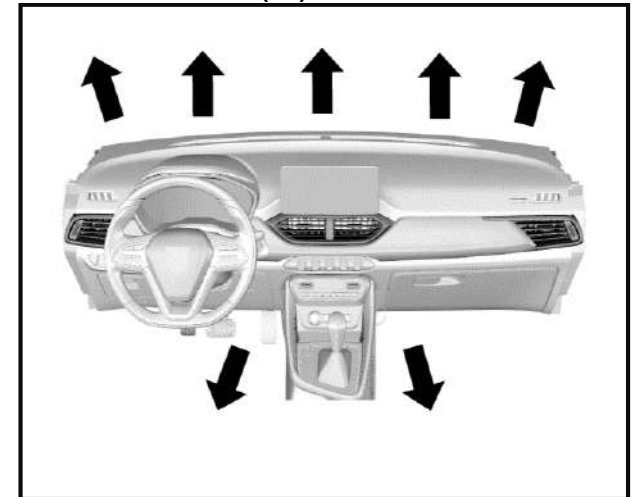

In this mode, air flows out from the front windshield defroster air outlet, the front door window defroster air outlet, the floor air outlet, the front seat lower air outlet and the side air outlet.

**Internal Circulation Mode Button**



You can press this button during driving on a dusty road, or when you want to prevent the exhaust or outside smoke entering inside, or when you want to quickly decrease or increase temperature in the passenger area. The indicator will illuminate and the inside air will start to circulate internally. Press this button again to switch to the external circulation mode and the indicator will go out. The system memorizes the previously set air circulation mode the next time you start the vehicle.

**Caution**

**You may feel tired and sleepy after long-time driving in the internal circulation mode. Please switch to external circulation mode on a regular basis to acquire fresh air.**

**Front Windshield Defroster Button**



Press the button to select the front windshield defroster mode.

Press the front windshield defroster button and the air volume ascends to Range 4 automatically. If the air volume is already higher than Range 4 before the button is pressed, it will remain at the range.

As you switch from the air blow mode to the defroster mode, the indicator below the button illuminates. As you turn on A/C function, the indicator on the A/C button illuminates.

The air circulation mode switches to external circulation.

Press the button again to turn off the front defroster mode and the system restore to the state before defrosting.

**Rear Windshield Defroster Button**

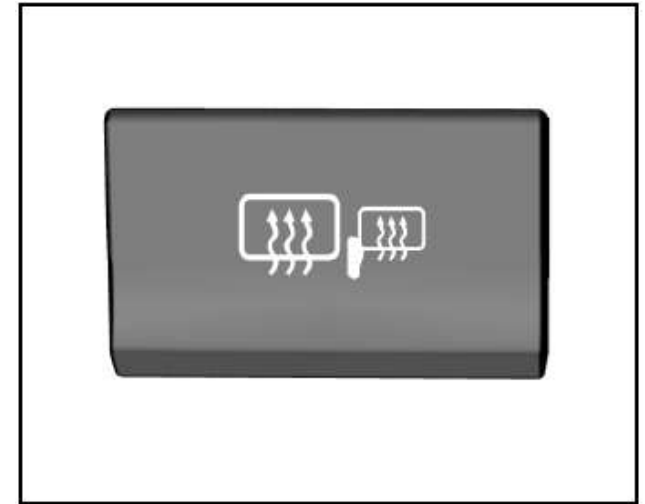

To turn on the defroster, first turn on the ignition switch and then press the rear windshield defroster button. The indicator on the button illuminates. Please turn off the defroster after your view becomes clear.

After you press the button, the defroster will work for about 15 minutes and then turn off automatically.

If the vehicle is equipped with an outside rearview mirror defroster, this defroster also works as the rear windshield defroster works.

**Caution**

Lack of proper maintenance may cause damage to the defroster or scratches on the glass.

It is not allowed to use any sharp cleaner or that prone to cause glass wear to clean the rear windshield.

During vehicle cleaning or when operating near the rear windshield, please take care not to shake or damage the defroster wire.

If the driver's view is affected, an accident can happen, causing personal injuries, damage to the vehicle or property loss.

**Caution**

Usage of the rear windshield defroster is prohibited under the following circumstances:

- The engine is not running.
- Snow or ice has deposited on the rear windshield.

If you use the rear windshield defroster under these circumstances, the vehicle battery can become under voltage.

**Manual Air Conditioning  
Control Panel**

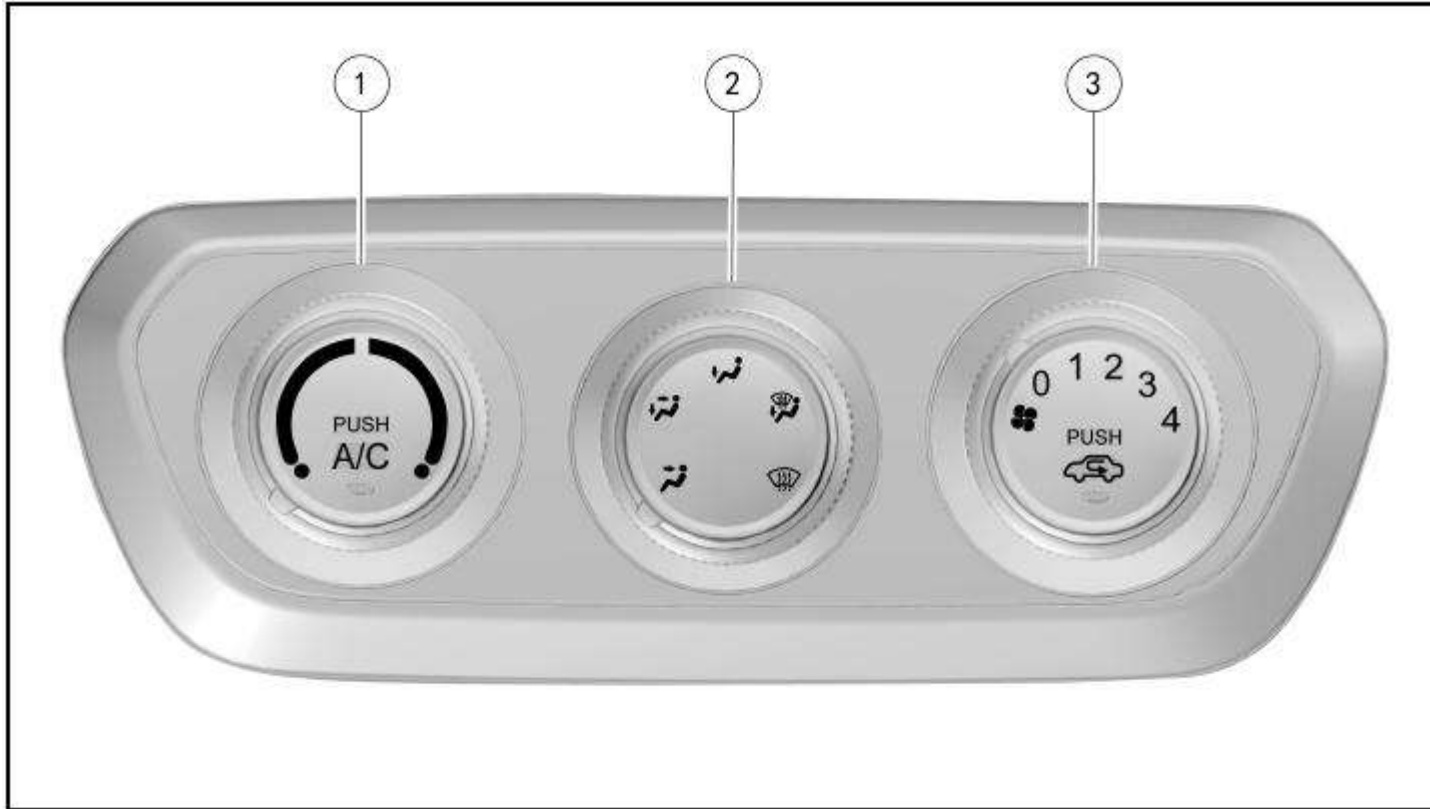

1. Temperature control knob/air conditioning (A/C) button
  2. Air distribution mode button/rear windshield defroster button\*
  3. Fan control knob/internal circulation button
- Note: The position corresponding to the marker on the button edge is just the selected function mode.



**Temperature Control Knob**

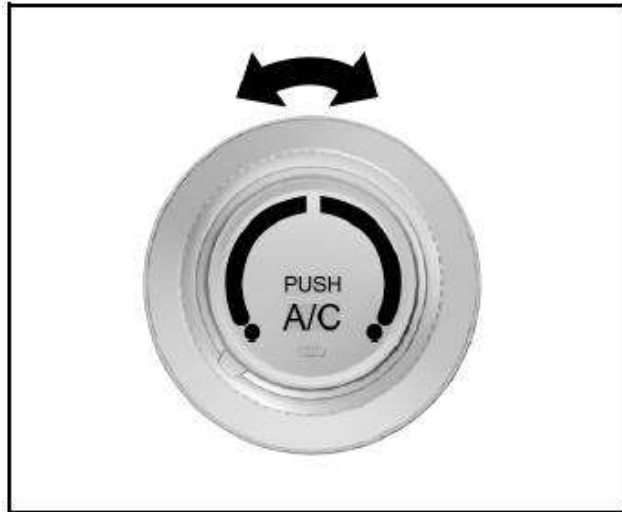

It is used to control temperature of the air flowing out from the air outlet.  
 Turn the knob to the blue area and cool air comes out; to the red area and warm air comes out.

**Fan Control Knob**



Turn the fan speed control knob to control the system air flow.  
 A total of 4 ranges are available and the air volume is the greatest at Range 4. Turn the knob to Range 0 and the air conditioning system turns off.

**Air Distribution Mode Knob**



Adjust the air distribution knob to the desired mode so that the air flows in the desired direction.  
 A total of 5 air blow modes are available and in each mode, the air is controlled to flow out from the corresponding air outlets. Please refer to the information provided above on electronic air conditioning.

**Internal Circulation Mode Button**

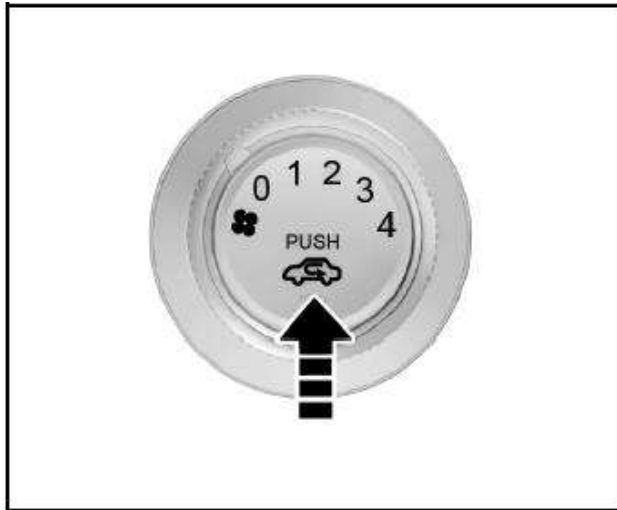

You can press this button during driving on a dusty road, or when you want to prevent the exhaust or outside smoke entering inside, or when you want to quickly decrease or increase temperature in the passenger area. The indicator on the button illuminates and air starts to circulate inside the vehicle.

Press this button again to switch to the external circulation mode, the indicator will go out and outside fresh air enters inside.

**Caution**

**You may feel tired and sleepy after long-time driving in the internal circulation mode, so please switch to the external mode on a regular basis to acquire fresh air.**

**Rear Windshield Defroster Button\***



To turn on the rear windshield defroster, first turn on the ignition switch and then press the rear windshield defroster button. The instrument on the button will illuminate. Please turn off the defroster after your view becomes clear. The defroster will also turn off automatically after working for about 15 minutes.

**Caution**

Lack of proper maintenance may cause damage to the defroster or scratches on the glass. It is not allowed to use any sharp cleaner or that prone to cause glass wear to clean the rear windshield. During vehicle cleaning or when operating near the rear windshield, please take care not to shake or damage the defroster wire. If the driver's view is affected, an accident can happen, causing personal injuries, damage to the vehicle or property loss.

**Caution**

Usage of the rear windshield defroster is prohibited under the following circumstances:

- The engine is not running.
- Snow or ice has deposited on the rear windshield.

If you use the rear windshield defroster under these circumstances, the vehicle battery can become under voltage.

**Air Conditioning System**

Refrigerating device of the air conditioning system is used to cool down the inside air and remove the moisture and dust contained in the air.

If the temperature control knob is already set to a comparatively high temperature, warm air will be generated inside the vehicle even though the air conditioning refrigeration (A/C) function is activated.

**Note**

After the air conditioning system is turned on, you can find water drops in the lower area of the engine compartment. The water drops are formed as moisture in the air condenses on surface of the air conditioning system component, which is a normal phenomenon.

**Note**

As the air conditioning compressor works, it consumes certain engine power. This is the reason why you may find that the vehicle power performance decreases when the air conditioning refrigeration function is activated.

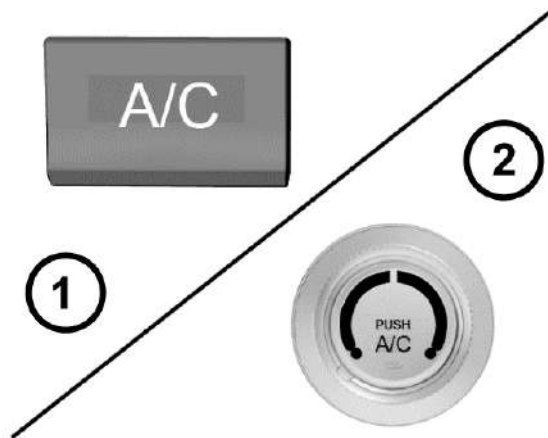
**Air Conditioning (A/C) Button**

To turn on the air conditioning (A/C) system:

1. Start the engine.
2. Press the air conditioning (A/C) button. The button indicator illuminates, indicating that the air conditioning system is working.
3. Adjust the fan speed.

To turn off the air conditioning system:

Press the air conditioning (A/C) button again. The button indicator goes out, indicating that the air conditioning system has stopped refrigeration.

If the air conditioning system was kept on when the engine was shut down the last time, the system will turn on automatically as the vehicle is started next time.

**Note****Note**

The air conditioning system cannot work if the fan control thumbwheel is turned to OFF position.

**Cool Air****Fast Cooling**

To cool down fast in scorching hot days or after the vehicle is kept under the blazing sun for a long time:

1. Open the door windows a little to expel the hot air inside.
2. Turn on the air conditioning (A/C) system. (The indicator illuminates at this time.)
3. Activate the internal circulation mode.
4. Switch the air distribution mode to face mode (↕).
5. Adjust the temperature to the maximum coolness.

6. Adjust the fan speed to the maximum.

**Normal Cooling**

1. Turn on the air conditioning (A/C) button. (The indicator illuminates at this time.)
2. Activate the internal circulation mode.
3. Switch the air distribution mode to face mode (↕) or dual mode (↔).
4. Adjust the temperature to the cool air area.
5. Adjust the fan speed to the desired value.



**Warm Air****Rapid Heating**

Activate the rapid heating mode to increase the passenger area temperature quickly. It is prohibited to activate this mode for a long time, otherwise the inside air quality will decrease and fog can form on the windows. To clear up the fog on the windows, turn off the internal circulation mode so that fresh air enters inside.

To acquire the warmest air:

1. Turn off the air conditioning (A/C) system. (The indicator goes out at this time.)
2. Activate the internal circulation mode.
3. Switch the air distribution mode to foot mode (↔).
4. Adjust the temperature to the maximum warmth.
5. Adjust the fan speed to the maximum.

**Normal Heating**

1. Turn off the air conditioning (A/C) system. (The indicator goes out at this time.)
2. Activate the external circulation mode.
3. Switch the air distribution mode to foot mode (  ) or dual mode (  ).
4. Adjust the temperature to the warm air area.
5. Adjust the fan speed to the desired value.

**Ventilation**

**Dual Mode**



This mode is applicable to cool and sunny days. Warm air is controlled to flow to the floor area and outside cool air is controlled to flow to upper portion of the compartment. The method to use this setup is:

1. Activate the external circulation mode.
2. Switch the air distribution mode to dual mode (  ).
3. Adjust the temperature to the desired value.
4. Adjust the fan speed to the desired value.

**Ventilation**



To control the air to flow out from the central air outlet and the side air outlet:

1. Turn off the air conditioning (A/C) system. (The indicator goes out at this time.)
2. Activate the external circulation mode.



3. Switch the air distribution mode to face mode (  ) or dual mode (  ).
4. Adjust the temperature to the cool air area.
5. Adjust the fan speed to the desired value.

**Rapid Defrosting and Defogging**

**Please operate in the following steps in cold weather:**

- Air conditioning switch (A/C): ON (southern area) or OFF (northern area)
- Air inlet mode: to external circulation
- Air distribution mode: 
- Temperature switch: to warm air
- Air volume switch: to the maximum
- To keep the front windshield clean and divert warm air to the floor, please choose foot/defroster (  ) mode.

**Please operate in the following steps if not in cold weather:**

- Air conditioning switch (A/C): ON
- Air inlet mode: internal circulation (  ); switch to external circulation after the fog has lift.
- Air distribution mode:  or .

- Temperature switch: to the area that ensures passenger comfort.
- Air volume switch: to the maximum

**Note**

**At the beginning of defrosting and defogging with the warm air, the fog can become thicker, please take care to ensure driving safety.**

## Driving and Controls

Driving Instructions .....	110
Vehicle Control .....	110
Emergency Measures.....	110
Start and Operation .....	111
Trial Run of New Vehicle .....	111
Mechanical Ignition Switch Position*.....	112
ENGINE START STOP Switch Position* .....	112
Electronic Steering Column Lock* .....	113
Engine Starting .....	113
ENGINE START STOP Function* .....	114
Cruise Control System *.....	115
Engine Immobilizer System .....	116
Parking .....	116
MT Transmission * .....	117
Operation for Shifting Transmission with Six Drive Gears to reverse (R) gear .....	117
Brake.....	118
Anti-lock Brake System (ABS) .....	118
Electric Brake Force Distribution (EBD) System.....	120
Electronic Stability Control (ESC) System.....	120
ESC OFF Switch .....	120
Hill-start Hold Control (HHC) System * .....	121
Parking Brake .....	121
Electric Power Steering (EPS) System.....	122
Fuel .....	123
Fuel Suggestions.....	123
Fuel Filling .....	124

## Driving Instructions

### Vehicle Control

**Do not slide in case that the engine is out of operation.**

In such case, many systems (such as brake booster) cannot function. Driving in this way will form a danger to yourself and others.

#### Pedal

To ensure that the pedal travel is unhampered, the floor mat in the pedal area shall not be excessively thick, and no article shall be placed in the pedal area.

### Emergency Measures

#### Caution

**The operation time of the starter motor shall not exceed 10s once. Otherwise, the starter motor will get damaged or discharge of battery will occur.**

#### One Tire is Punctured When the Vehicle is Running

If one tire is punctured when the vehicle is running, the driver shall hold the steering wheel tightly to control the driving direction, slowly decelerate, turn on the hazard flasher, and gently depress the brake pedal to park your vehicle in a safe area.

#### Warning

**Do not brake suddenly when one tire is punctured. Braking suddenly will cause the vehicle to tilt towards one side, and thus an accident may be caused.**

#### One Fault Exists When the Vehicle is Running

If one fault exists when the vehicle is running, the driver shall turn on the hazard flasher, slowly decelerate, and park the vehicle in a safe area at the curb.

Place a warning triangle at a position 50 m behind the vehicle in the daytime while placing it at a position 100 m behind the vehicle at night. Please follow requirements of traffic laws and regulations.

After inspection, send the vehicle to the Aftersales Service Center for inspection and maintenance.

Place the warning triangle in the luggage compartment, or have the customer give it to you when the vehicle is being delivered.

#### If the Engine Does Not Work

In case that the ignition switch is at the START position, if the starter motor does not work, please check whether the battery is dead, whether the battery port is connected correctly and whether relevant fuses get damaged.

If the starter motor works but the engine fails to be started, please check fuel level, fuel filter, fuel pump, relevant wiring, etc.

The operation condition of the fuel pump can be preliminarily judged by hearing sounds made by the ignition switch when it is being turned on.

### Measures Taken in Case of Engine Overheat

When the vehicle is running, if the output power of the engine reduces suddenly or the warning lamp on the instrument indicating excessively high temperature illuminates, park your vehicle in a safe area and take following measures:

- Have the engine run at idle, and turn the transmission at the neutral position.
- Pull the parking brake lever.
- Turn off the A/C.
- Open the bonnet to ventilate the engine bay.
- If the level of the coolant reservoir does not drop, stop the engine to cool it.
- If the coolant level is very low, uncover the reservoir, slowly fill water in the reservoir drop by drop till the level reaches the MAX (maximum) level mark of the coolant reservoir.
- After taking provisional measures, immediately send the vehicle to the Aftersales Service Center for inspection.

#### Warning

**Do not open the bonnet if steam or coolant overflows from engine parts. Otherwise, you may be scalded by steam or coolant.**

**Caution**

**Suddenly filling cold water in the overheated engine will damage the engine.**

**The handling method above is taken in case of an emergency. When the engine gets overheated, you are suggested to contact the Aftersales Service Center for solution.**

**Caution**

**When the engine gets heated, uncovering the coolant reservoir will get steam or coolant overflowed, and thus your face or other body parts may be scalded.**

**If you are to uncover the coolant reservoir, you can do it after the engine cools down completely. Apply one cloth to the cover, open it slightly at first (by 1/3-1/2), and then open it fully after pressure in the reservoir is released completely.**

**Operation in Heavy Snow**

- Decelerate when the vehicle turns a corner, upgrades or crosses a bridge.
- Please avoid parking on a hard road shoulder; otherwise the snow shoveling work will be obstructed.
- Please keep safe distance from other vehicles; braking unnecessarily will be limited.

- Clear the accumulated snow around the vehicle frequently, for such measure can prevent the exhaust pipe from being blocked.

**Start and Operation****Trial Run of New Vehicle**

Following measures can be taken within the initial mileage of 500 km, which can improve the performance, promote the vehicle economy and extend the service life:

- Avoid starting the engine by depressing the accelerator fully.
- Do not keep the engine idling for a long time.
- Avoid any emergency shutdown except in an emergency. With this, the brake can run in well.
- Do not quickly start, accelerate suddenly and continuously keep the vehicle running at high speed if possible, to avoid any damage to the engine and save the fuel.
- Avoid accelerating by depressing the accelerator fully at a low gear and driving by depressing the accelerator greatly.
- Do not drag any other vehicle.

**Note**

**Please do not use such electric equipment as audio and head lamp for a long time under the condition that the engine is off. When getting out of the vehicle, please shut down the electric equipment for the vehicle, to avoid the battery from running out; if the battery runs out, the vehicle may fail to be started.**

### Mechanical Ignition Switch Position\*

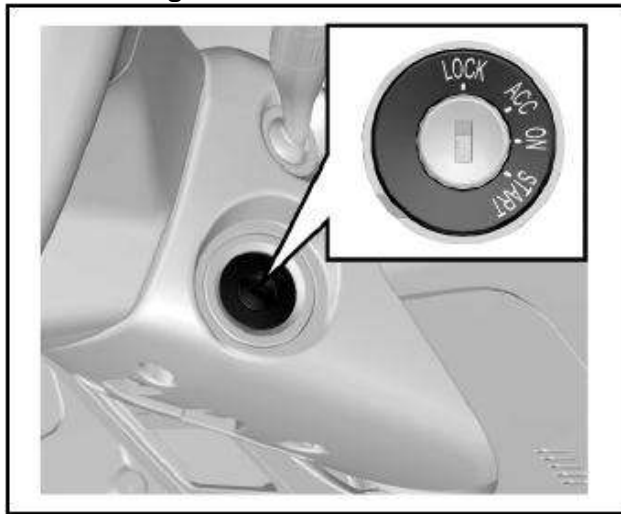

When the ignition switch is turned at the right side of the steering column, the operating positions are as follows: LOCK, ACC, ON and START.

- **LOCK**

Lock the steering wheel. Remove the key and turn the steering wheel till the steering wheel is locked.

If you cannot turn the key when unlocking the steering wheel, you can gently turn the steering wheel to right/left for one thing and turn the key for another.

- **ACC**

The engine can be shut down when the ignition key is turned to the ACC position without the need to lock the steering wheel. If you are to turn the ignition key from the ACC position to the LOCK position, you can gently press in the key and turn the key to the LOCK position.

When the ignition key is at the ACC position, some electrical accessories such as radio and cigar lighter can be used.

- **ON**

Connect the ignition system and electrical accessories.

**Note**

**Do not keep the key at the ACC position and the ON position for a long time when the engine is out of operation; otherwise the battery will be in insufficient voltage.**

- **START**

Start the engine. After starting the engine, release the key; the key will automatically return to the ON position.

Confirm that the engine does not operate before turning the ignition key to the START position.

**Caution**

**Never remove the key or turn the key switch when the vehicle is running. Otherwise, the brake assistance will disappear and the steering wheel may be locked. Therefore, the driver will lose control of the vehicle and thus the vehicle damage and the casualty accident may be caused.**

### ENGINE START STOP Switch Position\*

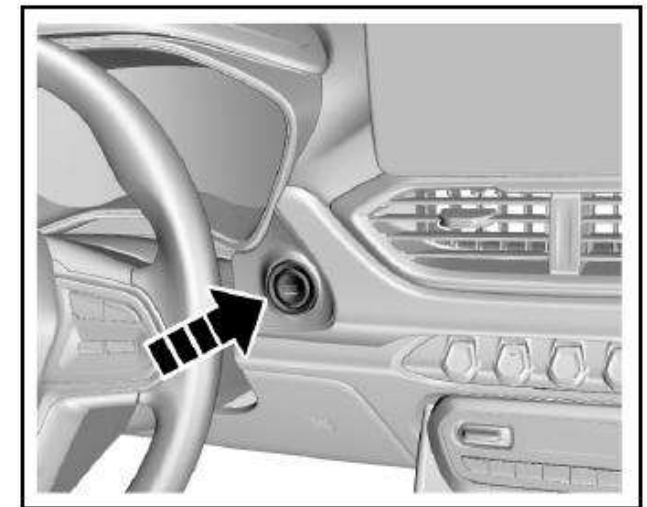

If equipped, the ENGINE START STOP switch is at the lower right side of the instrument cluster.

Working indicator on ENGINE START STOP switch:

Orange: It indicates that the ignition switch is at the ACC or ON position.

Green: It indicates that the start conditions are met.

When the working indicator turns green, if the transmission is at the neutral position, press the start switch and then the engine can be started.

When the power is switched from the low voltage to the high voltage, the system must be able to detect the legal key. Please place the key at one position near the ENGINE START STOP switch inside the vehicle, such as driver's pocket or instrument panel storage box.



In the sequence from the low voltage to the high voltage of power, the operating positions are as follows: LOCK, ACC, ON and START.

- **LOCK**

Parking is carried out at the position. The working indicator on the ENGINE START STOP switch does not illuminate and the vehicle power is off.

- **ACC**

Press the ENGINE START STOP switch at the LOCK position; the position can be switched to the ACC position. The orange working indicator on the ENGINE START STOP switch starts to illuminate. At the position, power supplies of some electrical accessories such as audio and cigar lighter are connected.

If no operation is conducted, the system will automatically return to the LOCK position 1h later, so as to reduce the consumed power.

- **ON**

Driving and start are conducted at the position.

Press the ENGINE START STOP switch at the ACC position once; the position can be switched to the ON position. The instrument cluster indicator illuminates, and the orange indicator on the ENGINE START STOP switch illuminates.

If you press the ENGINE START STOP switch once (without other operations) at the ON position, the switch will be turned to LOCK position.

- **START**

At the ON position, turn the transmission at the neutral position, and depress the clutch pedal. Then the green indicator on the ENGINE START STOP switch illuminates. Press the ENGINE START STOP switch once, and the engine will start. After the engine starts, the ignition switch keeps at the ON position.

- **OFF**

Press the start switch once (vehicle speed < 2 Km/h).

<b>Note</b>
<b>Never keep the engine idling at high speed for over 5 min.</b>
<b>Excess temperature will damage the exhaust system.</b>

<b>Note</b>
<b>If the transmission is not at the neutral position, the engine cannot start.</b>

### Electronic Steering Column Lock\*

As the electronic steering column lock is used to lock the steering wheel, the vehicle having the ENGINE START STOP function is equipped with the electronic steering column lock at the same time. You can hear the operating sound when the lock device is started or released.

If locking the steering wheel is required, following conditions shall be met at the same time:

1. The vehicle is motionless;
2. The ignition switch is at the LOCK position.

When conditions above are met, the steering wheel will be locked immediately if any one of following actions occur:

- Open or close the left front door.
- Remote locking
- Wait 24s later

If unlocking the steering wheel is required, you can just enter the vehicle with the legal key and press the ENGINE START STOP switch.

In the case that the steering column lock may be unable to be released when it is in the wheel-deviation forward direction, the instrument cluster will display "Failure in locking of electronic steering lock" and buzz for prompt. At this time, align the steering wheel, turn the ignition switch at the ON position, and then switch to the LOCK position, to make efforts to unlock the steering wheel. If unlocking fails, check the vehicle.

### Engine Starting

Before starting the engine:

- Ensure that no barriers exist around the vehicle.
- Ensure that all windows and doors are clean and transparent.

- Check whether the tire conditions and the inflation pressure are proper and whether foreign matters exist.
- Adjust the seat headrest to a proper position.
- Adjust the rearview mirrors inside/outside the vehicle.
- Fasten the safety belt and ask all passengers to fasten safety belts.
- When turning the key at the ON position, check the operating conditions of the warning lamp and the indicator on the instrument panel.
- Regularly (e.g., when refueling) check the maintenance items recorded in the Manual.

**Engine Starting:**

1. Apply the parking brake.
2. Ensure that seats and rearview mirrors are at proper positions. Adjust them if necessary.
3. Turn the ignition switch at the ON position.
4. Ensure that the gearshift lever is at the neutral position, and then depress the clutch pedal fully.
5. Do not depress the accelerator pedal, turn the ignition-switch key to the ON position, and release the clutch (or brake) pedal after the engine starts. For one model having the ENGINE START STOP function, click the ENGINE START STOP switch once to start the engine. If the engine starts temporarily and fails to operate, you can wait for 10s and then try again.

6. Keep the engine idling for more than 30s to heat the engine.
7. Release the parking brake.
8. Do not drive the vehicle at high speed before the engine temperature reaches the normal operating temperature.

Note
<p><b>Keep the engine idling for 3-5 min before the vehicle with the turbocharged engine starts to run, especially in winter or after storage for a long time, and after the engine oil is changed or the engine is maintained.</b></p>

Note
<ul style="list-style-type: none"> <li>● Do not keep the starter running continuously for over 10s.</li> <li>● It may be difficult to start the vehicle in extremely low temperature.</li> <li>● It may be difficult to start the vehicle in one high-altitude area.</li> <li>● If the engine fails to start, please wait for 10s and then restart so as to avoid any damage to the starter.</li> </ul>

**Turbocharged Engine Shutdown**

After keeping the turbocharged engine operating at high speed for a long time, please firstly keep it idling for 3-5 min and then kill it, so as to cool the turbocharger. Otherwise, the turbocharger may get damaged due to overheat.

Note
<p><b>Avoid the turbocharged engine from idling for a long time; the idling time shall not exceed 20 min.</b></p>

**ENGINE START STOP Function\***

**Start Condition**

Following conditions shall be met for engine start:

1. The legal key is inside the vehicle;
2. Depress the clutch pedal.

If conditions above are met, the green indicator on the ENGINE START STOP switch will illuminate. In this case, if the gear is at the neutral, press the start switch and the engine will immediately start.

**Other Control Instructions**

1. Emergency start
  - The brake or clutch switch failure will make the start conditions unable to be met, and thus the engine cannot start in the normal procedures. You can firstly turn the ignition switch at the ACC position, confirm that the transmission is at the neutral, and then long press the ENGINE START STOP switch for 15s. In this case, emergency start of the engine succeeds.

- Insufficient battery of the remote key may cause the system to fail to search for the key and thus the engine fails to start. In this case, you can firstly depress the clutch pedal, and at the same time attach the side of remote key with the Baojun emblem close to the ENGINE START STOP switch. When the green indicator on the ENGINE START STOP switch illuminates, press the switch to start the engine. Please try again if you fail. You shall replace the battery of the remote key.

## 2. Emergency flameout

If emergency flameout of the engine is required when the vehicle is running, you can long press the ENGINE START STOP switch for 2s or continuously press for 3 times within 3s.

### Caution

**Never have a kid operate the ENGINE START STOP switch in any case; otherwise unexpected start or flameout of the vehicle, and the vehicle damage and the casualty accident may be caused.**

### Caution

**Never operate the ENGINE START STOP switch when the vehicle is running. Accidental vehicle flameout may suspend braking and assistance of the steering system. In this case, the driver will lose control of the vehicle and thus the vehicle damage and the casualty accident may be caused.**

## Cruise Control System \*

### Type I Switch

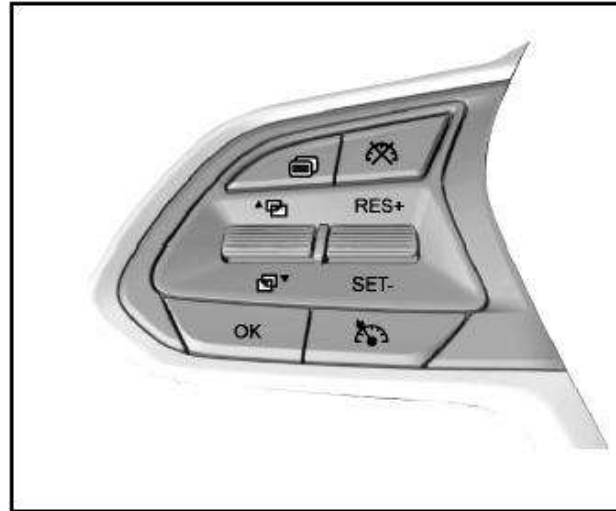



### Type II Switch







As the switch of cruise control system is at the steering wheel, when the cruise control system is started, the vehicle can run at such speed. Depress the brake pedal, and the function will be immediately disabled. Except that the brake pedal is used to disable the function, operating switches such as parking brake switch and clutch switch can also be used to disable the function of the cruise control system. The system can be used at 3, 4, 5 and 6 gears with the speed range of 40 Km/h - 120 Km/h when the engine speed is lower than 4800 rpm. For the AT model, the minimum speed for starting the cruise control system is 48 Km/h. Specific application method:

### First Step: Cruise Start

Based on the cruise control system switch type, press the “” button or pull the toggle button towards “” direction, and then the cruise indicator on the instrument cluster starts flickering, indicating that the cruise control system enters the activated state; pull the toggle button towards the “SET/-” direction, and the cruise start succeeds and the cruise indicator of instrument is normally on. (For example, when the driver intends to stabilize the speed at 100 km/h, the driver must firstly speed up to 100 km/h. When the speed reaches 100 km/h, he/she shall press the “” toggle button and then pull the toggle button towards the “SET/-” direction. At this time, release the accelerator pedal, and the vehicle will continuously run at the speed of 100 km/h). After setting the cruising speed, you can also use the accelerator pedal to accelerate in the normal method; after the accelerator pedal is released, the system will recover the speed to the original cruising speed.

**Second Step: How to Deactivate Cruise**

If you are to immediately decelerate in case of any emergency in front during cruise control, you can depress the brake pedal or clutch pedal, or press the cruise deactivation button “” or pull the toggle button towards “” direction. In this case, the vehicle exits from the current cruise state and enters the cruise activation state, and the cruise indicator of instrument flickers; if you press the “” button or pull the toggle button towards “” button in the cruise state, the whole cruise system will be deactivated and the instrument indicator will go out.

**Third Step: Operation for Cruise Recovery**

When the vehicle exits from the cruise state and enters the cruise activation state, if you are to carry out the cruise control at the previous cruising speed, you just need pull the toggle button once towards the “RES/+” direction. Then cruise control is carried out at the previously-saved speed recovered. For example, the cruising speed is 60 Km/h before braking and becomes 50 Km/h after braking, and at the time the cruise indicator of instrument flickers. Pull the toggle button once towards the “RES/+” direction; the cruise indicator will be normally on, and the vehicle will automatically speed up to 60 Km/h and enter the cruise control state.

**Fourth Step: How to Promote Cruise Control Speed**

Pull the toggle button towards the “RES/+” direction and the set cruising speed will rise without the need to depress the accelerator pedal. The speed will rise by 2 km/h every time you pull up the switch once. If the toggle button is kept pressed, the vehicle speed will continuously rise. Once the switch is released, the then running speed will be saved into the memory and the vehicle will cruise at the speed.

**Fifth Step: How to Reduce Cruise Control Speed**

Pull the toggle button towards the “SET/-” direction to reduce the cruising speed. The speed will reduce by 2 km/h every time you pull down the switch once. If the toggle button is kept pressed, the vehicle speed will continuously reduce. Once the control lever is released, the then running speed will be saved into the memory and the vehicle will cruise at the speed. If the toggle button is released when the vehicle speed reduces to about 40 km/h (less than 40 km/h), the saved value will be deleted. If you are to continuously drive at the cruise control speed, you need reset the cruising speed.

**Caution**

**In principle, the cruise control system can be used on one expressway or one totally-closed road.**

**It is not allowed to use the cruise control system in rainy, icy and snowy weather, and on one densely-hillside road or densely-crooked road.**

**Cruise control is also not proper on a rugged pavement and when too many vehicles run on one road.**

**Note**

**For the MT model, after the cruise control system is started, if you intend to shift the transmission to the neutral position, always depress the clutch pedal firstly. Otherwise, it may cause the engine to overspeed and thus get damaged.**

**Engine Immobilizer System**

The vehicle with the engine immobilizer system has the extra anti-theft capacity, for the system can prevent any unauthorized person from starting the vehicle. The matching key of the engine immobilizer system has been encoded electronically. The electronic transceiver is concealed in the ignition key. Only a valid key can be used to start the engine. However, an invalid key can also be used to open doors. The engine immobilizer system isolates the power supply from the ignition system, the fuel pump and the fuel injector. When any unauthorized person turns the invalid key to the START position, the engine immobilizer system fails to identify the electronic code. Therefore, the engine cannot start and the immobilizer system indicator will be flickering.

**Note**

**If the vehicle is equipped with one steering wheel mechanical lock again, a better anti-theft result will be realized.**

**Parking**

- When the parking brake is used for parking, the button shall be released after parking. When parking on a ramp, tension the parking brake as tightly as possible and depress the brake pedal at the same time.
- Shut down the engine and turn off the ignition switch. Turn the steering wheel till the steering wheel is locked by the steering wheel lock.

- When parking the vehicle on one uphill ramp, turn the front wheels away from the road shoulder.
- When parking the vehicle on one downhill ramp, turn the front wheels towards the road shoulder.

**Caution**

Do not park and drive the vehicle on inflammables such as straw and hay. If such inflammables cannot be avoided, park the vehicle to check and confirm that these inflammables are not attached at the chassis after the vehicle passes the inflammables. Otherwise, these inflammables may be ignited by high-temperature components on the chassis, and thus a fire accident is caused.

**MT Transmission \***

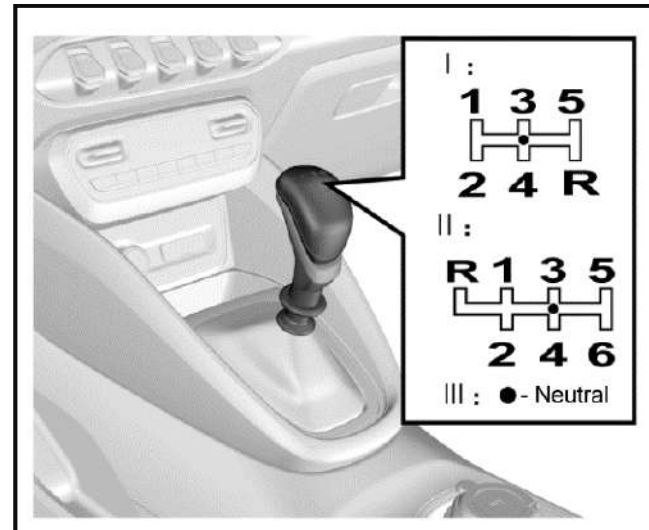

Shift the gear as per gear positions marked on the gearshift lever ball after the clutch is released. If you have to shift to the reverse gear, you must firstly stop the vehicle, completely depress the clutch pedal, and then shift the gearshift lever from the neutral (N) gear to the reverse (R) gear.

- 1: First drive gear 2: Second drive gear
- 3: Third drive gear 4: Fourth drive gear
- 5: Fifth drive gear 6: Sixth drive gear (if any)
- R: Reverse gear

Depress the clutch pedal completely when shifting gear. Do not always put your foot on the clutch pedal during driving.

**Operation for Shifting Transmission with Six Drive Gears to reverse (R) gear**

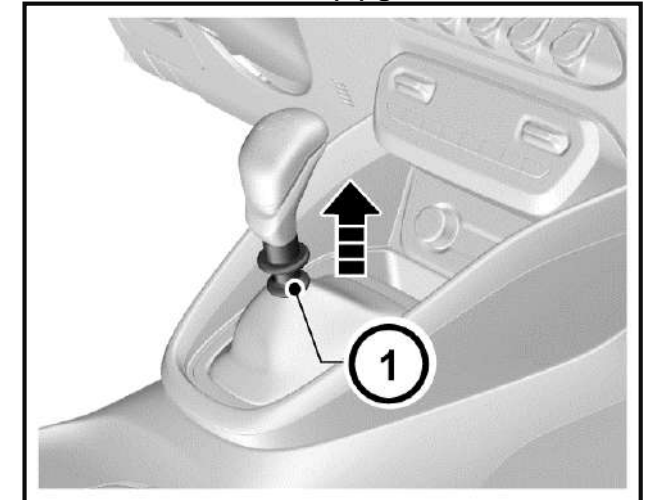

As shown in the figure above, when shifting the transmission with six drive gears to the reverse (R) gear, pull up the reverse gear lock ring firstly and then turn the gearshift lever from the neutral (N) gear to the reverse (R) gear.

Take care not to pull the reverse gear lock ring when shifting to the drive gear, so as to avoid from shifting to the reverse gear accidentally.

**Note**

When shifting between the drive gear and the reverse gear, be sure to ensure that the vehicle comes to a complete stop. After completely depressing the clutch, wait for a moment and engage a gear. Otherwise, the transmission may get damaged or the transmission service life may be shortened.

**Note**

When reversing your vehicle, please slowly start and confirm that the vehicle is shifted to the reverse (R) gear, for engaging a wrong gear may cause an accident.

**Warning**

Always putting your foot on the clutch pedal during driving will damage the engine and the clutch system and increase the consumed fuel volume.

**Brake**

The brake system is designed for the braking performance under the driving conditions in wide range. In the braking process, the vehicle speed is reduced through the braking friction and the friction between tires and ground. It is normal that small braking friction sounds and friction sounds between tires and ground are given with no need for special treatment; it is also normal that occasional squeals are given in braking. Squeals may be produced for such causes that other matters may adhere to the friction faces during operation of the vehicle, the vehicle is out of operation for a long time, or friction faces get rusted after raining. If squeals are produced at a lower frequency, there is no need for special treatment.

To avoid the pedal travel from being influenced, do not lay a thick carpet in the brake pedal area.

If you find that the brake pedal fails to return or the brake pedal travel becomes longer, we strongly advise you to have your vehicle inspected at the Aftersales Service Center. This may indicate a faulty brake system.

**Note**

When you drive your vehicle in one high-altitude area, continuously braking may cause the brake pedal force to increase.

**Note**

To run in the friction plate and the brake disc and confirm the performance and the service life, after purchasing a vehicle and installing new friction plates, you had better avoid emergency braking or braking for a long time within millage of 200 km.

**Warning**

Please check whether the stop lamp is normal before driving your vehicle. Keep the vehicle running at low speed after starting the vehicle, and check the braking performance. You shall do more like this especially after your vehicle is just washed. The wet brake may cause an accident. In case the brake is wet, the brake fails to function well and thus the vehicle may be out of control due to lateral deviation. As a result, after driving through water or having your vehicle cleaned, keep the vehicle running at low speed and depress the brake pedal intermittently and gently, so as to dry the brake.

If the brake is unable to brake temporarily due to overheat. Engage a lower gear when driving downhill and use the engine to brake.

If the brake is unable to brake temporarily due to wet components, the normal performance can be recovered with the help of following procedures:

1. Check whether there are vehicles behind your vehicle.
2. Keep safe driving speed to ensure there is sufficient space behind your vehicle and at both sides of your vehicle.
3. Carefully depress the brake till the normal performance is recovered.

**Anti-lock Brake System (ABS)**

As one advanced electric braking system, the anti-lock brake system (ABS) is helpful in avoiding the vehicle from slipping and losing control, and this system can also provide the maximum braking capability on the slipped pavement.

When the ignition switch is connected, the ABS warning lamp illuminates momentarily. The ABS warning lamp does not go out or illuminates when the vehicle is running, indicating the ABS is faulted. Please immediately contact the Aftersales Service Center. Refer to “ABS Warning Lamp” under Chapter “Instrument and Control Device”.

The ABS will monitor the speed of each wheel during braking. If one wheel tends to be locked, the system will control brakes of two front wheels and two rear wheels respectively. When the ABS works, the brake pedal often vibrates slightly with noise.

**Warning**

**If the ABS gets faulted, it may be unable to function, wheels may be locked in case of emergency brake, and the vehicle may be unable to steer or may steer suddenly.**

**Note**

**The ABS will neither change the time required for brake engagement, nor shorten the braking distance. Sufficient braking distance must be kept even the ABS is equipped.**

### Electric Brake Force Distribution (EBD) System

The EBD system uses the high-speed computer to respectively induce and calculate different ground to which four wheels are attached, and thus calculate different friction values at the moment the vehicle brakes. Therefore, four wheels can be able to brake in different ways and force based on different conditions, and can be adjusted fast during movement, so as to ensure that the vehicle is stable and safe.

### Electronic Stability Control (ESC) System

The ESC system is a new-type active safety system, representing the further development of the functions of anti-lock brake system (ABS) and traction control system (TCS). In addition, the yaw rate sensor, lateral acceleration sensor and steering wheel turn angle sensor are added. The driving force and braking force of front and rear, left and right wheels are controlled through the ECU, which ensures the lateral stability of the vehicle. When the driver operates the vehicle beyond the limit values, in case of turning at high speed, the ESC system automatically intervenes to ensure that the vehicle returns to be controllable and ensure the safety. Indicators relevant to the ESC system consist of ABS MIL, EBD MIL, ESC MIL and ESC OFF indicator.

1. Indicators illuminate for self-check when the ignition switch is connected. The 4 indicators are normally on for 3s, indicating that the ESC system is conducting self-check and indicators work normally. The 4 indicators go out 3s later under the normal condition. When faults (such as neglected installation, loosened connector, abnormal CAN communication) exist on the ESC system, only the ESC OFF lamp will go out 3s later, and other 3 lamps are normally on.

2. In the process of driving the vehicle, if the ESC function is activated, the ESC lamp will flicker, telling the Owner that the ESC system is working. If the ESC system functions abnormally but the ABS+EBD system functions normally, the ESC lamp is normally on, indicating that the ESC system gets faulted. If the ESC system and the ABS function abnormally and the EBD system functions normally, the ESC lamp and the ABS lamp are normally on. If the ESC system, the ABS and the EBD system function abnormally, the ESC lamp, the ABS lamp and the EBD lamp are normally on.
3. The ESC OFF lamp is used to indicate that the ESC function is disabled (the lamp will be normally on so long as the ESC function is disabled; the lamp will go out if the function is enabled). If the Owner presses the ESC OFF switch, some ESC functions will be disabled, and the ESC OFF lamp illuminates. When the switch is pressed, the ESC system is working, and the ESC function will not be disabled immediately and will be disabled after the work is over. If the Owner presses the ESC switch again, all functions will be enabled again. If the pressed time of ESC switch exceeds 10s, the ESC system will consider it as one incorrect operation (for example, the switch is pressed by one unknown article incautiously), the ESC function will not be disabled.
4. The ESC system will be activated automatically after every re-ignition.

#### Note

The ESC system may not be able to help you escape from out-of-control in the ultimate state for sure. Therefore, take care during daily driving. You had better disable the ESC system when crossing country on a sandy and rocky pavement. As it is time for the ESC system to function on an icy, snowy and slippery pavement, the ESC system shall not be disabled.

#### ESC OFF Switch

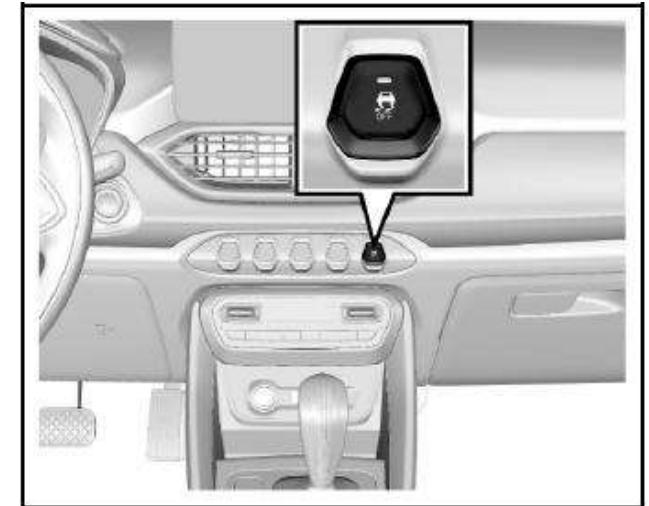

Press the ESC OFF switch after starting the vehicle, and the ESC OFF lamp on the instrument cluster illuminates and some ESC functions are disabled. Press the ESC switch again, the ESC function is enabled again and the ESC OFF lamp on the instrument cluster goes out.



Normally, it is not recommended to disable the ESC system. The system should be disabled temporarily only when the vehicle gets out of the mire or the vehicle climbs on a snowfield, etc.

### Hill-start Hold Control (HHC) System \*

The ESC system has the HHC function. The function can help the vehicle to start easily on a slope without using the parking brake.

Whether the driver is driving or reversing onto a hill, the start assistant is provided through the function. Therefore, engage gear before starting, please.

When the hill-start hold control functions, after the brake pedal is released, the vehicle still keeps the braking force for 1-2s. In this case, the vehicle will not slide backwards.

For one MT vehicle, the driver can focus on engagement of accelerator and clutch in 2s, so as to deal with the tense hill-start with ease.

In 2s, if the driving force applied by the driver is greater than the resistance which the vehicle is subject to when running onto a hill, the system will gradually reduce the braking force and the vehicle starts running smoothly. If the vehicle fails to start running in 2s, or the driving force applied by the driver is insufficient, the pressure of the brake system is released automatically and the vehicle may start sliding a slope. At the time, you can depress the brake pedal to make the vehicle come to a complete stop, and the system will still help you to conduct the next start (when conditions are met). Conditions for the HHC system to function:

1. No fault exists on the system, and the engine has been operating;
2. The vehicle is motionless and the brake pedal has been depressed;
3. The drive gear or reverse gear has been engaged;
4. The system detects that the gradient value is met. (In theory, when the slope is > 4%, the vehicle will nod during braking, and the nodding angle will offset the slope. As a result, the system may fail to be started on a ramp whose slope is > 4%.)

### Warning

**The HHC function may fail to prevent the vehicle from sliding a slope on a very slippery or steep hillside. Only as one driver-assistance measure, the HHC function cannot supersede the parking brake function. Always conduct the parking brake when getting out of the vehicle. If there is no sufficient driving force provided after the brake pedal is released, the vehicle will slide backwards. At this time, please immediately draw back the parking brake and depress the park pedal. If the engine flames out during the process, please immediately draw back the parking brake and depress the park pedal.**

### Parking Brake Mechanical Hand Brake \*

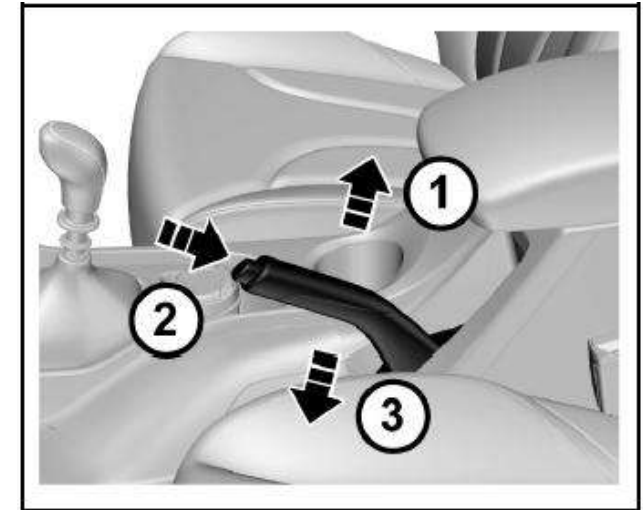

The parking brake impacts rear wheels.

The parking brake lever is between two front-row seats. If you are to conduct the parking brake, you should stop the vehicle, depress the brake pedal and tension the parking brake lever.

When you are to release the parking brake, depress the brake pedal and take following measures:

1. Draw back the parking brake lever slightly.
2. Press the button on the parking brake lever joint.
3. Release the parking brake lever when holding the button pressed.

When parking on a downhill or uphill pavement, tension the parking brake as tightly as possible.

- When parking the vehicle on one uphill ramp, turn the front wheels away from the road shoulder.
- When parking the vehicle on one downhill ramp, turn the front wheels towards the road shoulder.

Vehicle equipped with a manual transmission:

1. Turn the gearshift lever to the neutral gear when parking the vehicle on the horizontal ground.
2. Turn the gearshift lever to the reverse (R) gear when parking the vehicle towards the downhill direction.
3. Turn the gearshift lever to Gear 1 when parking the vehicle

When parking one automatic model with dual clutch transmission, engage Gear P on all pavements.

**Caution**

**If the parking brake is not engaged correctly, the vehicle may move automatically due to out-of-control in some cases (such as in case of parking on a ramp) and thus a danger may be caused. When necessary, please have the Aftersales Service Center adjust.**

**Note**

**Do not drive the vehicle with the parking brake not released; otherwise the rear wheel brake may get overheated or be subject to premature wear. As a result, you must replace the rear wheel brake; otherwise, other components of the vehicle may get damaged.**

**Electric Power Steering (EPS) System**

The EPS system provides the steering assist for the vehicle. The power steering fluid is not required for the system, which brings great convenience for the daily vehicle maintenance.

When the ignition switch is connected, the EPS MIL illuminates momentarily. The EPS MIL does not go out or illuminates when the vehicle is running, indicating the EPS system is faulted. In case of such condition, you need immediately go to Aftersales Service Center to check.

When the EPS system is under extreme conditions of high load work for a long time (For example, the steering wheel is “turned to the end” for a long time, or the vehicle is moved into the garage at low speed repeatedly to a wide angle), the thermal protection function may be activated due to excessively high temperature of electrical elements.

The system will reduce the power assist after it enters the thermal protection state, and at the time you have to steer the wheel with great force. If the normal power assist need be recovered, you can steer the wheel at a smaller angle or promote the vehicle speed. You can restart the vehicle when necessary.

**Note**

**The EPS system will adjust the power assist according to the vehicle speed. As a result, the steering wheel can be turned easily at low speed and be turned relatively steady at high speed.**

## Fuel

### Fuel Suggestions

Fill GB 92# gasoline for vehicle or gasoline with the equivalent standard No., or gasoline with a higher standard No. Using the fuel with an extremely low octane value will reduce power and torque of the engine, and increase the consumed fuel volume.

### Do not Use Methyl Alcohol

Do not use the fuel containing methyl alcohol on the vehicle. This fuel will reduce the vehicle performance and damage the fuel system components.

### Driving in Other Countries

When driving your vehicle in other countries:

- Please follow all registration and insurance regulations.
- Confirm that the country can provide proper fuel.

### Caution

If you use any incorrect fuel, the engine and the catalytic converter will get seriously damaged. Always use the fuel suitable for your vehicle.

For the purpose of safety, the fuel tank, pump and pipe must be grounded correctly. The static electricity will ignite vapor included in the gasoline. You will get burnt and the vehicle will get damaged.

### Dangers

The fuel is one of flammables or explosives. Smoking is prohibited. Keep away from open flames, sparks and smoking materials. If gasoline catches fire, serious burns will be caused and your vehicle will get damaged.

If you smell fuel odors, please immediately ask Aftersales Service Center to repair according to the fault cause.

### Caution

Using the fuel with an extremely low octane value will lead to uncontrolled burning and cause the engine to be damaged. Using the fuel containing methyl alcohol is not allowed for the vehicle design. Therefore, do not use the fuel containing methyl alcohol. As the methyl alcohol will corrode the metal parts in the fuel system and damage the plastic and rubber parts. The damage caused due to use of the fuel containing methyl alcohol does not belong to the warranty scope. If contents of manganese and iron exceed the standard, the three-way catalytic converter may be blocked, and the spark plug misfires, etc. Therefore, please use the gasoline meeting requirements of the national standard.

**Dangers**

Shut down the engine and any heating devices provided outside the combustion chamber before refueling. Turn off all mobile phones. Follow operation and safety instructions of gasoline station when refueling.

**Fuel Filling**

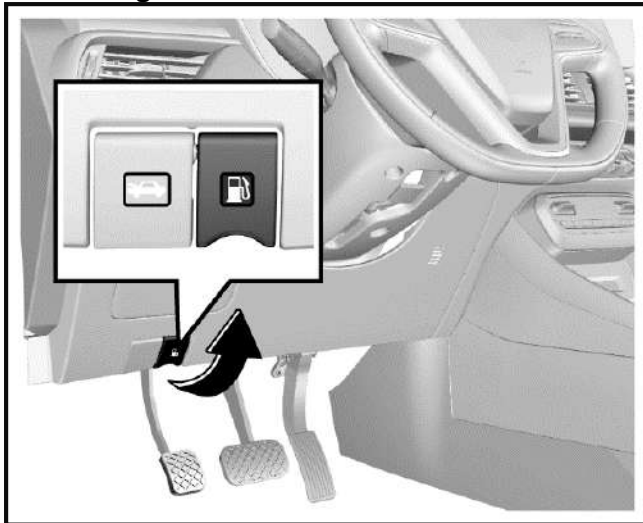

1. Stop the engine from running.
2. Pull up the filler flap release handle at the left lower side of the instrument panel to open the filler flap.

**Warning**

If you fail to open the filler flap in the cold weather, you can gently tap the filler flap. Then, try again.

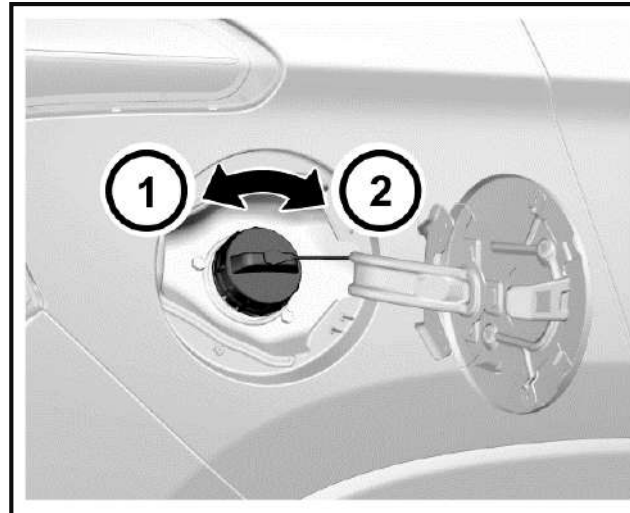

3. Slowly turn the filler cap anticlockwise. If you hear the hissing sound, wait till the sound stops, and then unscrew the cap.
4. Unscrew the filler cap. The filler cap is connected to the filler flap with the chain. Hang the chain to the hanger on the filler flap to secure the filler cap.
5. Reinstall the filler cap after refueling. Turn the filler cap clockwise till clicks are heard.
6. Tightly close the filler flap.

## Vehicle Service & Maintenance

General Information.....	126	Emergency Trailer.....	156
Accessories and Vehicle Retrofitting.....	126	Getting Vehicle out of Trap.....	158
Vehicle Storage.....	126	Vehicle Maintenance.....	158
Driver Checklist.....	127	Cleaning Agent.....	158
Exterior.....	127	Vehicle Interior Maintenance and Cleaning.....	159
Interior.....	127	Glass Surface.....	159
Engine Compartment.....	128	Vehicle Exterior Maintenance and Cleaning.....	160
Engine Oil.....	130	Corrosion Prevention.....	160
Engine Oil Level Check.....	130		
Engine Oil and Oil Filter Replacement.....	130		
Coolant.....	131		
Brake and Clutch Fluid.....	132		
Brake/Clutch Fluid Adding.....	132		
Transmission Fluid.....	134		
Transmission fluid leakage check.....	134		
Windshield Washer Solvent.....	134		
Windshield Wiper.....	135		
Air Filter.....	135		
Air Filter Cleaning.....	135		
Drive Belt.....	136		
Brake Pedal.....	136		
Brake Pedal Travel Check.....	136		
Fuse.....	136		
Indoor Fuse Box.....	137		
Engine Compartment Fuse Box.....	137		
Indoor Fuse Box Layout.....	138		
Engine Compartment Fuse Box Layout.....	139		
Lamp Bulb Replacement.....	140		
Bulb Specifications.....	141		
Wheels and Tires.....	147		
Maintenance.....	147		
Internal Tread Wear Indicator.....	148		
Tire Rotation.....	148		
Winter Tire.....	149		
Tire Chain.....	149		
Spare Tire, Jack and Tools.....	149		
Tool Kit.....	149		
Spare Tire.....	150		
Jack Lifting Point.....	151		
Tire Replacement.....	152		
Jump Start (Dead Battery).....	154		
Vehicle Traction.....	155		

## General Information

### Accessories and Vehicle Retrofitting

We recommend using original spare and accessory parts and parts and components that are approved by the company to be particularly suitable for the vehicle. We may not be able to guarantee the compatibility of other products with this vehicle, even if these products meet the specified requirements or are otherwise approved.

For parts of environmental protection, including the engine, transmission, coating, fuel evaporation control device, crankcase emission control device, OBD, ECU, catalytic converter, muffler, EGR (if any), supercharger (if any) and intercooler (if any), it is preferable to use original spare and accessory parts. Otherwise, vehicle emissions may not meet the standard.

The Company is not responsible for any problem caused by the use of non-original parts and components (including but not limited to the non-compliance of environmental emissions due to the use of non-original parts and components or other violations of laws and regulations).

Without the approval of **SGMW**, do not retrofit the electrical system.

#### Tips for Glass Filming

During the process of glass filming, the cleaning solution may easily enter electronic components around the instrument panel, causing electrical faults. Please complete waterproofing work before filming.

### Caution

**Do not retrofit the vehicle. Otherwise, the performance, durability and safety of the vehicle may be affected; problems caused by retrofitting are not within the scope of warranty.**

### Vehicle Storage

#### Long-term Storage

Several months of storage of the vehicle:

- Clean the vehicle for waxing.
- Check the wax coating of engine compartment and the underbody.
- Clean and protect the rubber seal.
- Replace the engine oil.
- Drain the washer fluid reservoir.
- Check coolant antifreezing agent and corrosion protection.
- Adjust the tire pressure according to the specified value under full load.
- Park the vehicle in a dry and well-ventilated area. Shift to Gear 1 or reverse gear to prevent the vehicle from sliding.
- Close all doors and lock the vehicle.

- Disconnect the clip from the vehicle battery negative terminal. Pay attention to that all systems are out of service at this time, e.g. theft deterrent system.

#### Vehicle being Put into Operation again:

- Connect the clip to the vehicle battery negative terminal. Enable the electronic device of power window.
- Check the tire pressure.
- Fill the washer fluid reservoir.
- Check the engine oil level.
- Check the coolant level.

## Driver Checklist

Check the interior, exterior and engine compartment regularly to keep the vehicle safe and reliable.

### Exterior

#### Tire

- Inflate tires correctly. (Refer to “Wheels and Tires” in this chapter).
- There is no crack on tire wall or tire tread.
- There is no foreign matter in tread pattern.

#### Lamp

- It includes all driving lamps, headlamps, tail lamps, turn signal lamps, brake lamps and fog lamps.

#### Oil Tank

- Check whether the level of fluid containers under engine hood is appropriate.

#### Windshield Wiper

- Check the state of wiper arms and blades.

### Interior

#### Steering

- Check whether the steering wheel is too loose (free travel).

#### Parking Brake

- Ensure the travel of parking brake lever is appropriate.

#### Instrument Panel

- Check whether all instruments, control buttons and warning lamps are functioning normally.

#### Rearview Mirror

- Ensure the reflecting surface of rearview mirror is in good state and clean.
- Check whether all rearview mirrors can be readjusted.

#### Control

- Check the brake pedal and clutch pedal for appropriate travel.

## Engine Compartment

### 1.5T Engine

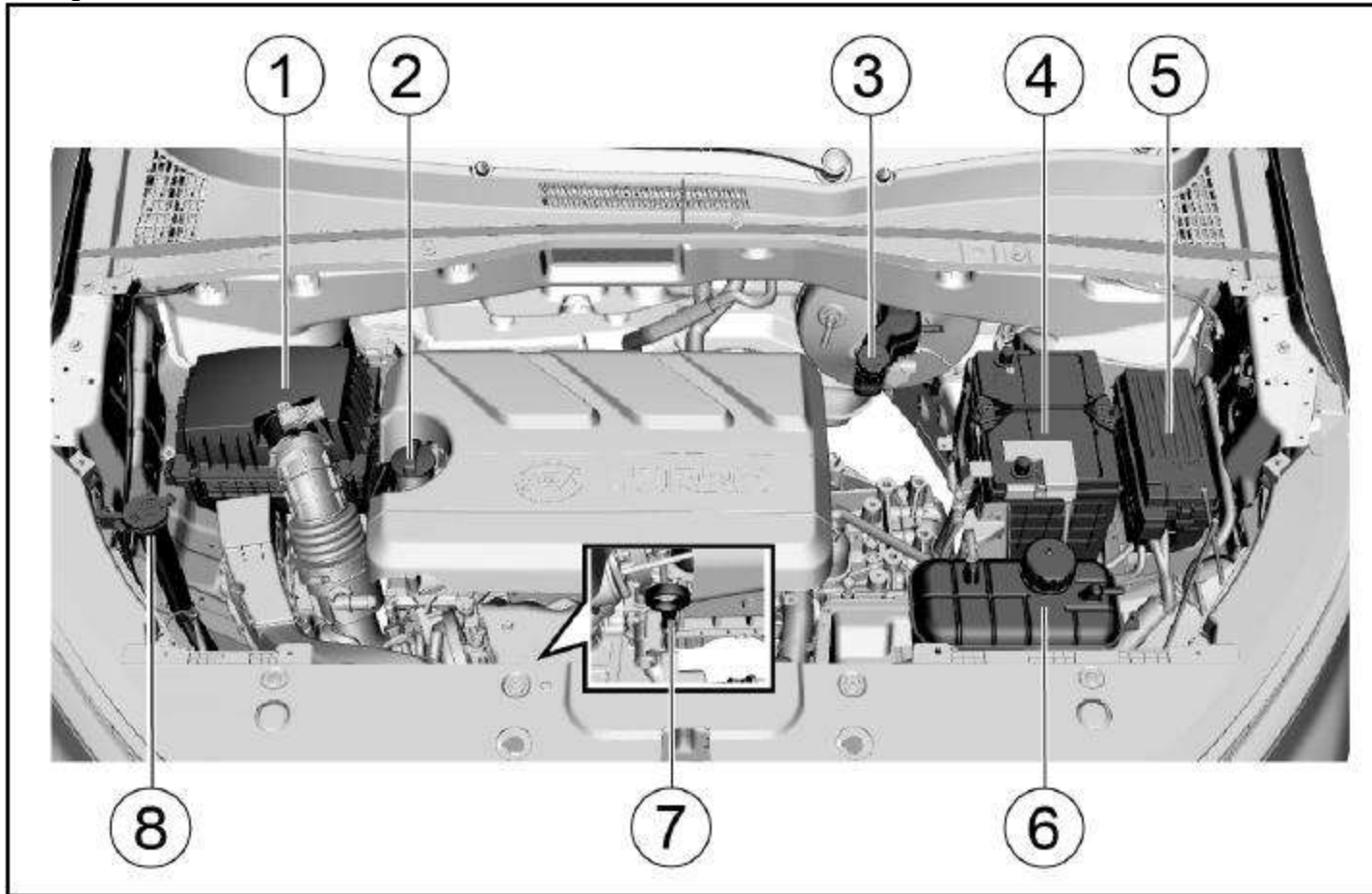

1. Air filter
2. Engine oil filler cap
3. Brake/clutch fluid reservoir
4. Battery
5. Fuse and relay box
6. Coolant pot
7. Engine oil dipstick
8. Windshield washer solvent container





## Engine Oil

Maintain the engine oil at a proper level to ensure correct lubrication of engine.

It is normal that the engine consumes some oil.

Check the engine oil level regularly, e.g. every time parking for refueling.

If the engine oil pressure warning lamp “” on the instrument panel is on, check the engine oil level immediately.

### Engine Oil Level Check

1. Park the vehicle on a horizontal ground.
2. After the engine stops running, wait for a few minutes to have the oil back to the oil pan. For cold engine, the time for the oil returning to the oil pan will be relatively long.
3. Pull out the oil dipstick and clean it.
4. Insert the oil dipstick completely.
5. Pull out the oil dipstick again.
6. Check the engine oil on the dipstick to ensure that the oil is free of contamination.

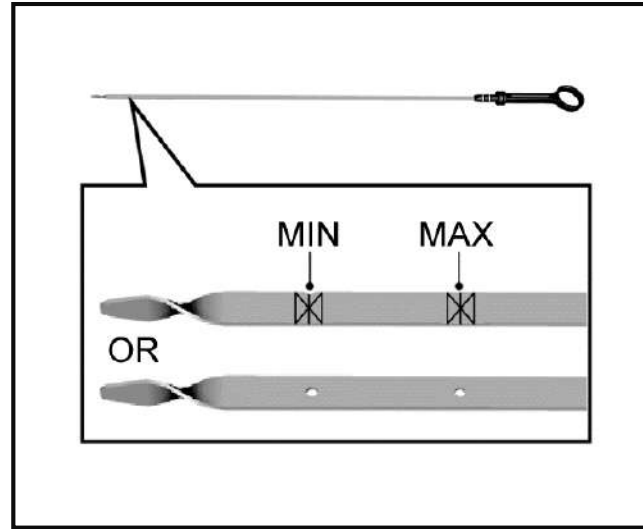

7. Observe the oil level via the oil dipstick. The oil level should be between the lower limit and the upper limit.
8. If the oil level is lower than the lower limit, add engine oil of the same grade to have the oil level approaching to but not higher than the upper limit. The engine oil filler cap is on the cylinder head cover. Refer to the diagram of “Engine Compartment”.

### Caution

**Engine oil is irritating and can cause illness or fatal danger in case of swallowing.**

- Keep it out of reach of children.
- Avoid repeated or prolonged skin contact with engine oil.
- Wash the part in contact with engine oil with soap water or hand sanitizer.

### Note

**Prohibit the engine oil level from being higher than the upper limit mark on the oil dipstick. Excessive engine oil may have adverse effect on the engine, including:**

- Increased engine oil consumption.
- Oil spilling of spark plug.
- A large amount of carbon deposits accumulated on the engine.

### Engine Oil and Oil Filter Replacement

The engine oil will lose the lubricating capacity after being contaminated. Be sure to replace the engine oil in accordance with maintenance procedures. The oil filter must be replaced at the same time of engine oil replacement every time. Under harsh conditions, the replacement interval of engine oil and oil filter must be shorter than the interval specified in standard maintenance procedures.

### Caution

**This work requires professional skills, tools and equipment; therefore, please go to the Aftersales Service Center for help. Otherwise, it may cause personal injury or damage to the vehicle.**

**Harsh conditions include but not limited to:**

- Frequent cold start.
- Frequent starting and stopping in case of traffic jam.
- Frequent driving for short trips.

- Frequent driving at an outside temperature of below 0 °C.
- Long time idling.
- Frequent driving at low speed.
- Frequent driving under dusty conditions.

**Caution**

The engine oil and oil drum are harmful to human health.  
 Avoid repeated or prolonged exposure to engine oil. In case of contact with engine oil, wash the skin with soap water or hand sanitizer. Keep this kind of toxic substance out of reach of children.  
 Engine oil is irritating to the skin and can cause illness or fatal danger in case of swallowing.

**Note**

It is prohibited to dispose of old engine oil and filters together with household garbage.  
 It shall make use of local legal waste management facilities.  
 Old engine oil and filters contain harmful substances that are harmful to human health and threaten the environment.

**Note**

The use of non-specified or poor quality engine oil or additives will cause damage to the engine. Please consult the Aftersales Service Center before attempting to use additives.

**Coolant**

The vehicle cooling system is filled with ethylene glycol coolant.

This kind of coolant in right mixing ratio can provide excellent anti-corrosion and antifreezing performance for the cooling and heating systems.

When the engine is in a cold state, the coolant level shall be between MIN (minimum) and MAX (maximum) marked on the coolant tank. The coolant level rises with the engine temperature rise and drops as the engine cools.

If the coolant level is lower than the MIN (minimum) mark, please go to the Aftersales Service Center for coolant filling or replacement.

**Note**

Ordinary water or coolant in wrong mixing ratio will cause damage to the cooling system.  
 It is prohibited to use ordinary water, alcohol or methanol on the vehicle to prevent freezing.

**Caution**

Under pressure, hot coolant and steam may spray out, causing serious personal injury.  
 It is prohibited to open the coolant tank cover before the engine and radiator cool down.

**Caution**

The coolant is a dangerous substance.

- Avoid repeated or prolonged exposure to coolant.
- In case of contact with coolant, wash the skin and fingernail with soap water.
- Keep it out of reach of children.
- Coolant is irritating to the skin and can cause illness or fatal danger in case of swallowing.

**Brake and Clutch Fluid**

There is a brake and clutch fluid reservoir on the vehicle. The brake and clutch fluid is moisture-absorbing, and the fluid with excessive water content will reduce the efficiency of the hydraulic brake/clutch system. Replace the fluid as per the instruction in the Manual to avoid corrosion of the hydraulic system.

Be sure to use the brake/clutch fluid recommended by **SGMW**. Add fluid into the reservoir to reach a proper level. The fluid level shall not be lower than the MIN (minimum) mark or higher than the MAX (maximum) mark. The cause of excessive low brake fluid level may be leakage of brake system or normal wear of brake pad/lining. Please contact the Aftersales Service Center to ensure that whether the system needs to be repaired. If repairs are necessary, add fluid after repair of hydraulic braking system. When the brake fluid level is lower than the lower limit, the braking system warning lamp “**Brake/Clutch Fluid Adding**



1. Thoroughly wipe off the dirt around the reservoir filler cap.
2. Open the filler cap.
3. Add the brake/clutch fluid recommended by **SGMW** to reach the MAX (maximum) mark. Be careful not to spill the fluid on the paint surface. In case of spilling on the paint surface, wash the area with cold water immediately.
4. Re-install the reservoir filler cap.

**Note**

Before opening the filler cap, clean the area around the brake/clutch fluid reservoir filler cap. Contamination of the brake/clutch fluid system will affect the system performance, resulting in costly repairs.

**Caution**

The brake/clutch fluid is irritating to the skin and eyes. Keep the skin or eyes from contact with the brake/clutch fluid. In case of contact, wash the part in contact with the brake/clutch fluid with soap water or hand sanitizer thoroughly.

**Caution**

It is prohibited to dispose of the old brake/clutch fluid as household garbage. It shall make use of local legal waste management organization. The old brake/clutch fluid and containers are dangerous and may be harmful to human health and the environment.

**Caution**

The brake/clutch fluid spilling over the engine may cause a fire. An overfull fluid reservoir is not allowed. Engine fire may cause personal injury and damage the vehicle and other properties.

## Transmission Fluid

### Transmission fluid leakage check

This work requires professional skills and equipment. To avoid personal injury or vehicle damage, it is suggested to go to the Aftersales Service Center for help.

## Windshield Washer Solvent

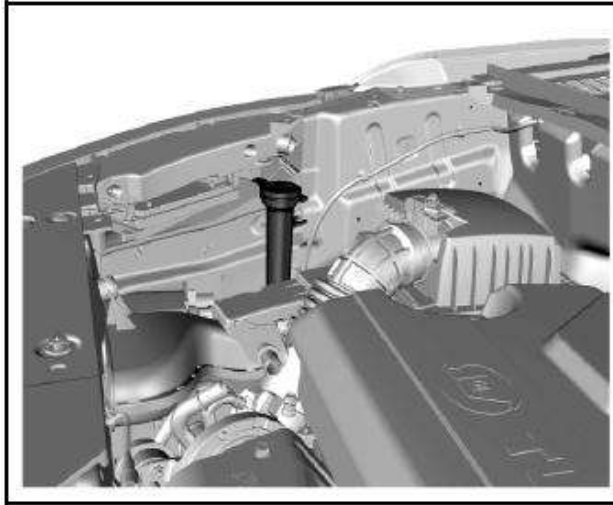

Before driving, be sure that the fluid reservoir contains sufficient specified washer solvent.

In cold weather, the windshield washer solvent container cannot be overfilled.

Washer solvent will swell under low temperature due to freezing. An overfull container has no enough space for expansion, thus resulting in damages.

### Note

Please go to the Aftersales Service Center for filling of the correct washer solvent.

Do not fill water or radiator antifreezing agent into the windshield washer solvent container. The water will lead the solution to freeze, and the frozen solution will damage the windshield washing system. The radiator antifreezing agent will damage the windshield washing system and vehicle paint.

### Note

**Add windshield washer solvent:**

It is suggested to use the ready-to-use special washer solvent. If concentrated washer solvent is used, please add water to dilute it according to the manufacturer's instructions.

Do not use tap water. Minerals or impurities contained in tap water may block lines of the windshield washer. If the temperature is likely to fall below freezing point, use windshield washer solvent with good antifreezing performance.

## Windshield Wiper

Foreign objects on the windshield and blade will reduce the effectiveness of the wiper. If the blade does not work properly, wipe the windshield and the blade with special or neutral washer solvent. Flush with water thoroughly. If necessary, repeat the above operation. Do not wipe the windshield with corrosive substances or materials that cannot be removed from the glass (e.g. silicone).

The strips have a layer of graphite on the surface for lubrication and protection. It should be protected from excessive wiping and undue polishing.

Do not start the wiper when the windshield surface is dry. Park the vehicle in a cool place as far as possible to prevent exposure to high-temperature, which will accelerate the aging and deformation of strips.

Remove foreign matters such as bird droppings, dust and leaves from the windshield surface before starting the wiper; otherwise, the service life of strips will be reduced.

### Notes on Front Wiper Blade Replacement:

The front wiper is of semi-concealed design. Before replacing the blade, operate the wiper to the maintenance position and then fold the wiper arm. Otherwise, the right wiper arm will contact the engine hood and damage the paint when being folded.

Method: Turn the ignition switch to ON position and then to LOCK position. Raise the wiper lever towards the steering wheel and release it (single-point contact) within 30s, and the wiper arm will swing to the maintenance position. After replacing the blade, lower the wiper arm and turn the ignition switch to ON position, and then the wiper will return to the original position.

## Wiper Blade Removal and Installation

Fold the wiper arm on the windshield for operation.

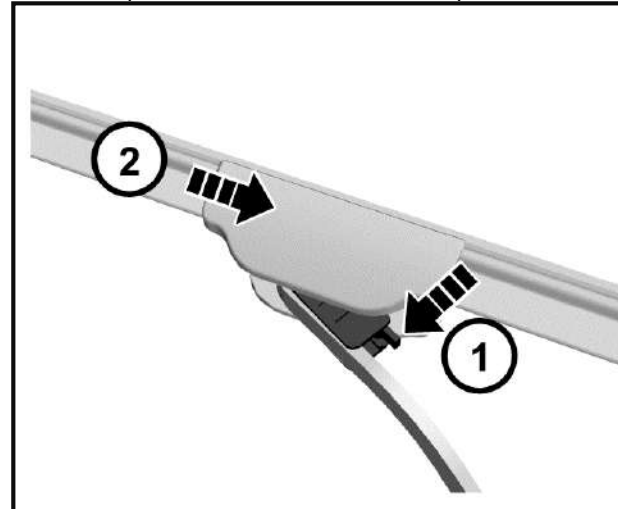

As shown in the figure, firstly press the release switch of the wiper blade in the direction of arrow 1. Then hold the joint part between the wiper blade and the wiper arm with the other hand. Pull the wiper blade down slightly in the direction of arrow 2 to separate the wiper blade from the wiper arm.

During installation, insert and clamp the new wiper blade into the U-slot of the wiper arm.

During the rear wiper blade removal, pull out the wiper blade from the installation point on wiper arm. For installation, align the blade with the installation point and press it into the point.

## Air Filter

Check and replace the air filter element regularly according to the maintenance instructions in the Manual.

### Air Filter Cleaning

If the air filter element is too dirty, clean it according to the following procedures:

1. Shake the air filter element to remove floating dust.
2. Clean the interior of air filter housing.
3. Cover the filter housing with a wet cloth when cleaning the filter element.
4. Clean the filter element with compressed air in the opposite direction of the engine intake.

### Note

**Clean air is necessary for the normal operation of engine. It is prohibited to drive the vehicle without the air filter element being installed. Otherwise, the engine will be damaged.**

### Drive Belt

For normal operation of engine and air compressor, the drive belt should be adjusted to a good state. In case of damage, break or wear, please replace the drive belt.

#### Caution

If the key is not pulled out, the engine may be start unintentionally during check. Do not leave the key in the ignition switch when checking the drive belt. Sudden running parts may cause serious personal injury when the engine is in operation.

### Brake Pedal

#### Brake Pedal Travel Check

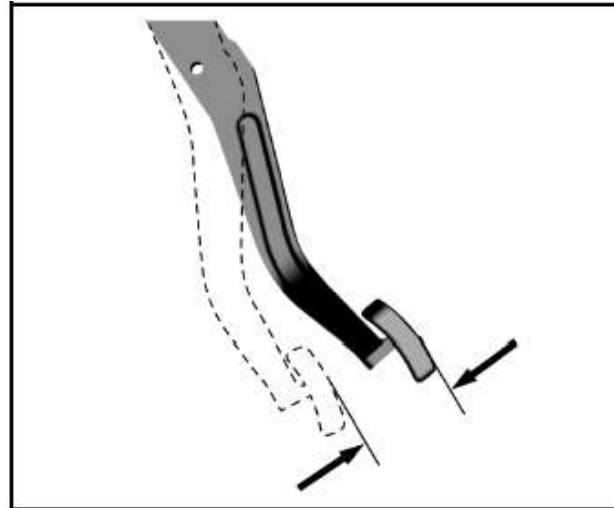

Brake pedal travel:

To avoid affecting the pedal travel, do not lay a thick carpet in the brake pedal area.

The reasonable range of brake pedal free travel is 0~30 mm.

If the brake pedal fails to return or the brake pedal travel becomes longer, please go to the Aftersales Service Center for inspection. This may indicate faults of the brake system.

### Fuse

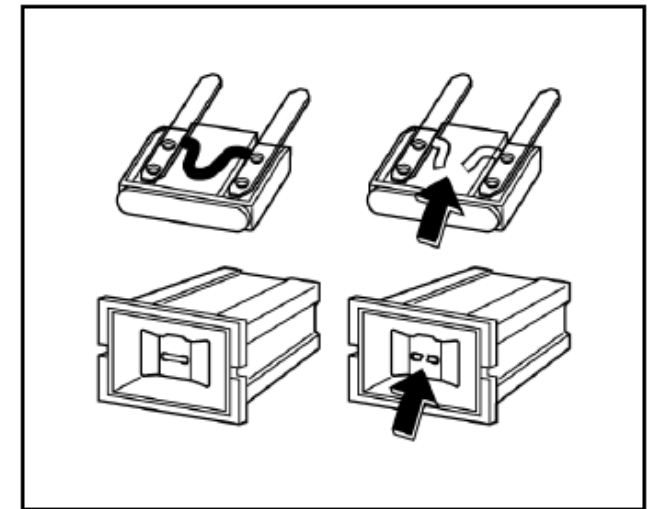

Fuse replacement:

1. Open the fuse box cover.
2. Identify damaged fuses by finding out blown fuses.
3. Use a fuse extractor to remove the blown fuses. The fuse extractor is in the engine compartment fuse box.
4. Figure out the cause of fusing and remove the fault.
5. Install new fuses with rated current meeting the requirements.



### Indoor Fuse Box

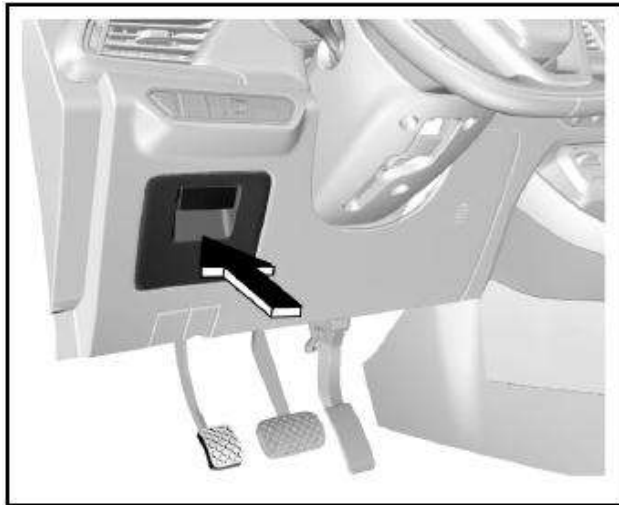

The indoor fuse box is on the lower left side of the instrument panel and it can be seen after pulling out the storage box.

### Engine Compartment Fuse Box

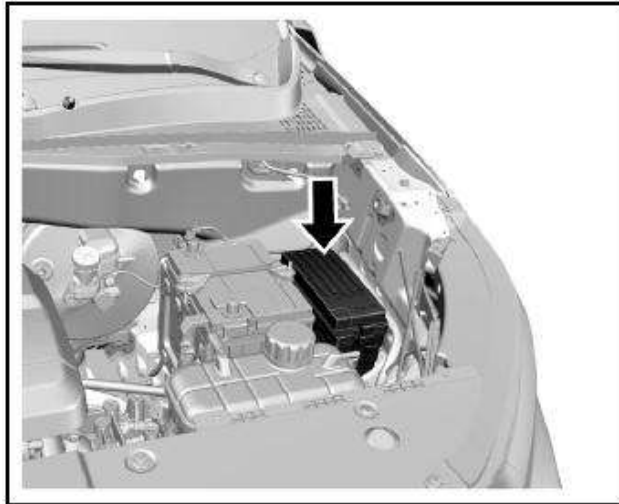

The engine compartment fuse box is next to the battery.

#### Caution

Do not use a conductive tool to remove the blown fuse. The fuse extractor must be used. The use of metal and other electric conductors may cause a short circuit, damage the electrical system or cause a fire, resulting in serious personal injury.

#### Caution

The use of fuse substitutes or the fuse with an incorrect type and current rating may damage the electrical system or cause a fire. Be sure to use a fuse of the type and current rating that meets the requirements. Otherwise, it may cause personal injury and damage the vehicle and other properties.

### Indoor Fuse Box Layout

For vehicles with different models or configurations, the layout of fuse box internal components may be different. The owner's actual vehicle shall prevail.

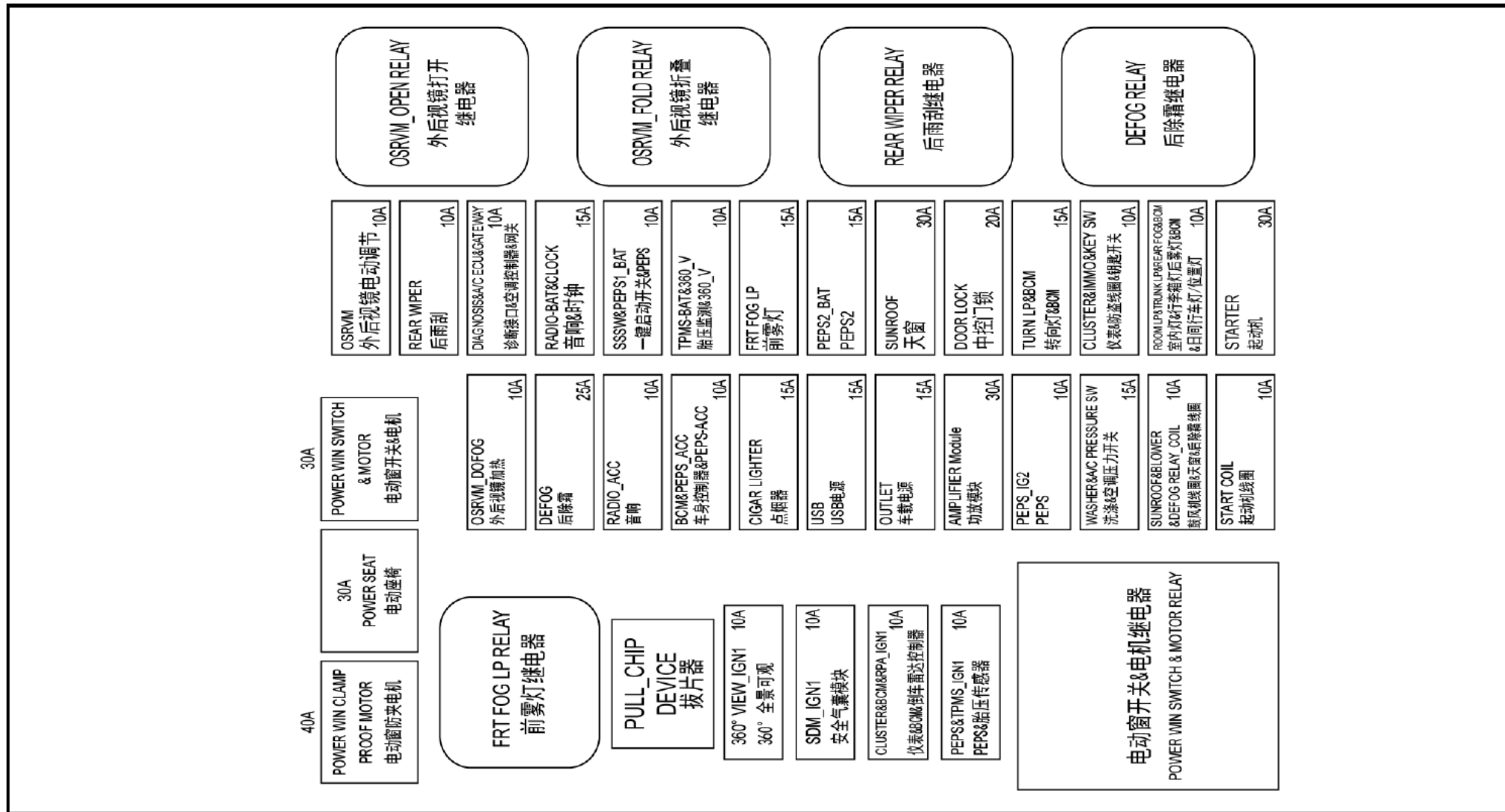

### Engine Compartment Fuse Box Layout

For vehicles with different models or configurations, the layout of fuse box internal components may be different. The owner's actual vehicle shall prevail.

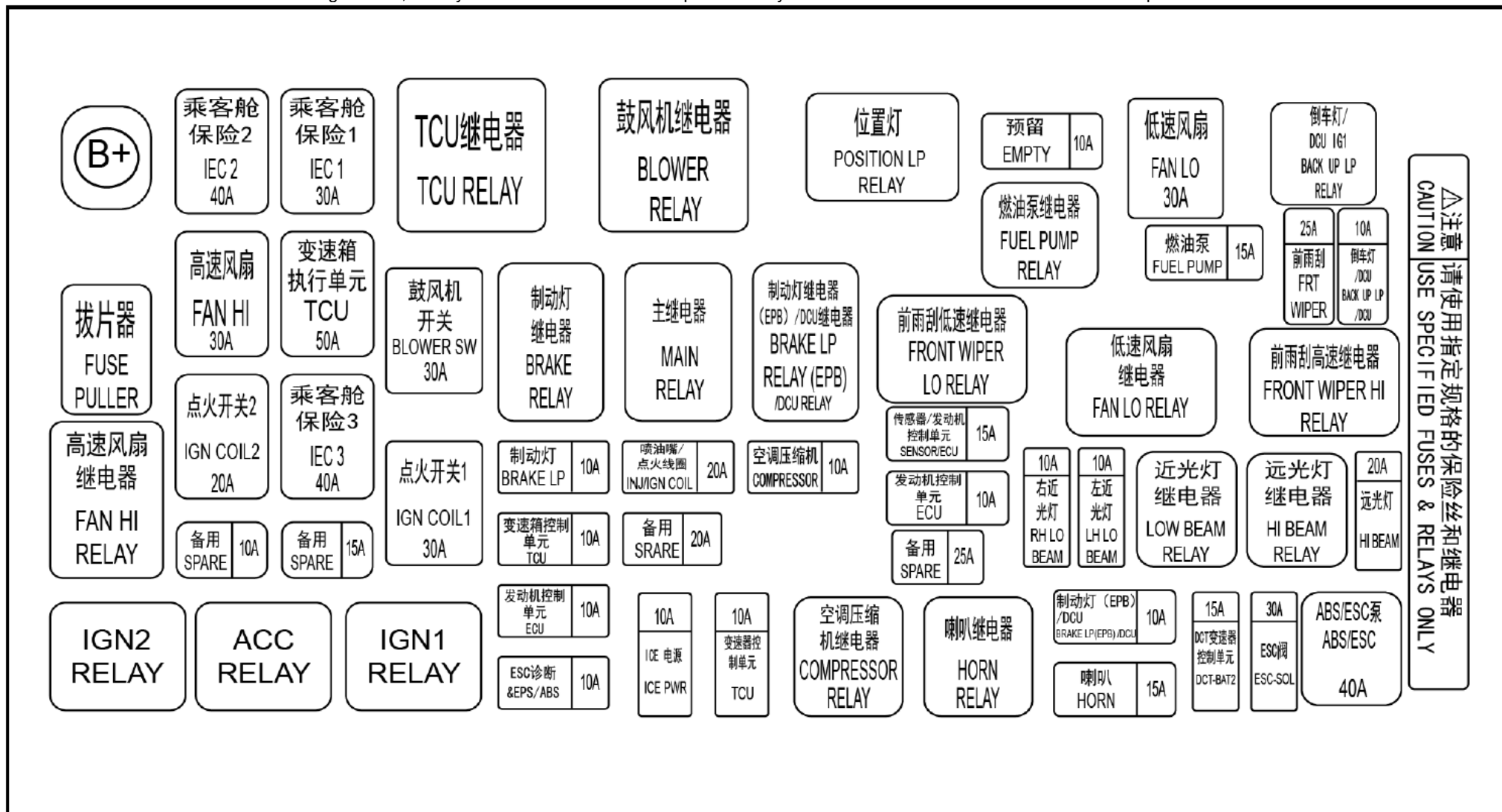

## Lamp Bulb Replacement

### Caution

The gas in the halogen bulb is under pressure. Handle with care and properly dispose of halogen bulbs.

- Wear safety glasses when removing or installing the lamp.
- Take care to prevent bulbs from wear and scratches.
- When the lamp lights up without being packaged, prevent the bulb from contacting liquids.
- Light up the lamp for test after the bulb being installed.
- Replace the cracked or damaged headlamp in time.
- Do not touch the glass portion with ungloved fingers when replacing the halogen bulb.
- Keep the bulb out of reach of children.
- Dispose of the old bulb carefully to prevent personal injury due to bulb explosion.

### Caution

Clean the halogen bulb with alcohol or mineral spirits and non-woven fabrics. Do not touch the bulb with hands directly.

Fingerprints may significantly shorten the effective service life of halogen bulbs.

### Caution

Professional skills and special equipment are required for replacement of bulbs. It is suggested to go to the Aftersales Service Center for help. Otherwise, it may cause personal injury or damage the vehicle.

### Lamp Fogging

When the temperature is low or the air is humid, there may be water mist inside the lamp. Turn on the lamp, and the water mist will dissipate after a while. If it is resulted from the weather, repair is not necessary.

If the water mist does not dissipate after the lamp is turned on and there is more and more water vapor, please contact the Aftersales Service Center for inspection.

**Bulb Specifications**

**High-end Configuration Model**



S/N	Lamp bulb	Power x quantity	Remarks
1	Front turn signal lamp/front position lamp/daytime running lamp	LED	
2	Low-beam lamp/high-beam lamp	LED	
3	Front fog lamp	55Wx2	H7
4	Side turn signal lamp	LED	
5	Front Reading Lamp	LED	
6	Rear Reading Lamp	LED	

High-end Configuration Model (Continued)



S/N	Lamp bulb	Power x quantity	Remarks
7	High mount stop lamp	LED	
8	Rear brake lamp/position lamp	21W/5Wx2	P21W/W5W
9	Rear turn signal lamp	LED	
10	Rear license plate lamp	LED	
11	Rear turn signal lamp	LED	
12	Backup Lamp	16Wx2	W16W
13	Rear Fog Lamp	21Wx2	P21W

High-end Configuration Model (Continued)



S/N	Lamp bulb	Power x quantity	Remarks
14	Rear position lamp	5Wx2	W5W
15	Luggage compartment lamp	LED	

Low-end Configuration Model



S/N	Lamp bulb	Power x quantity	Remarks
1	Trim		Non-luminance
2	Low-beam lamp/high-beam lamp	60Wx2	HB3
3	Front turn signal lamp	21Wx2	PY21W
4	Front position lamp	5Wx2	W5W
5	Side turn signal lamp	LED	
6	Front Reading Lamp	5Wx1	C5W
7	Rear Reading Lamp	5Wx1	C5W



Low-end Configuration Model (Continued)



S/N	Lamp bulb	Power x quantity	Remarks
8	High mount stop lamp	LED	
9	Rear brake lamp/position lamp	21W/5Wx2	P21W/W5W
10	Rear turn signal lamp	LED	
11	Rear license plate lamp	LED	
12	Rear turn signal lamp	LED	
13	Backup Lamp	16Wx2	W16W
14	Rear Fog Lamp	21Wx2	P21W

Low-end Configuration Model (Continued)



S/N	Lamp bulb	Power x quantity	Remarks
15	Rear position lamp	5Wx2	W5W
16	Luggage compartment lamp	LED	

## Wheels and Tires

Original tires guarantee optimum matching of riding comfort, tread life and performance.

### Caution

**Be sure to use wheels and tires of specified specifications. The use of wheels and/or tires of other specifications may result in abnormal operation of ABS and other relevant components and even cause collision accidents.**  
**Please consult the Aftersales Service Center before replacing original tires or wheels.**  
**Otherwise, it may cause personal injury and damage the vehicle or other properties.**

## Maintenance

The tire pressure shall meet provisions of the Manual so as to ensure optimum matching of driving comfort, safety and driveability.

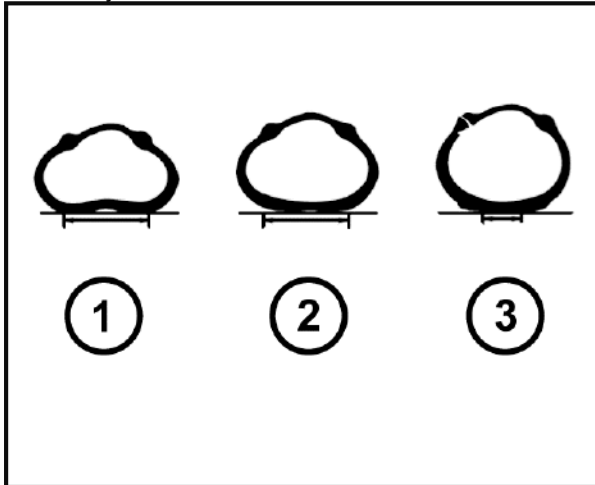

Refer to the tire load information label for the correct tire pressure. The label is on the sill plate below the driver's door.

At the time of cold start, check the tire pressure with an accurate tire pressure gauge. After check of tire pressure, tighten the valve core cap.

### Note

**Make sure to check the tire pressure at the time of cold start. The reading measured after the tire temperature has increased shall not prevail. Tires will become hot after traveling for 1.6 Km and will not cool down completely within 3h after stopping.**

Check the tire pressure each time when refueling or at least every month. Incorrect tire pressure may:

- Increase tire wear.
- Affect the vehicle manoeuvrability and safety.
- Affect the riding comfort.
- Reduce the fuel economy.

### Note

- **Vehicle overload is prohibited.**
- **Be sure to keep a proper tire inflation pressure.**
- **Be sure to check the tire inflation pressure at the time of cold start (ambient temperature).**

Excessively low tire pressure will cause overheat of the tire, leading to internal damage and layered tread and even tire burst when driving at a high speed. Even if the tire pressure was restored later, driving under too low pressure may have damaged the tire.

## Tire and Wheel Maintenance

Running over sharp objects may damage tires and wheels. If you have to run over these objects, please slow down. Do not touch the curb when parking.

### Regular Tire Check

- Appearance damage.
- Foreign material.
- Piercing.
- Cut.
- Crack.
- Protruding on side wall.

It shall also inspect the wheel for damage.

Tire defects including the above defects may lead to vehicle out of control, causing personal injury.

In case of damage or abnormal wear of tire or wheel, please consult the Aftersales Service Center for help.

The vehicle is equipped with radial tires. **SGMW** suggests replacing with radial tires of the same size, pattern, tread wear, temperature and rated speed.

**Note**

The use of tires with different size than the original tires may cause the tire and the vehicle component to interfere with each other, thus causing damage to the tire and vehicle.

**Caution**

If the vehicle is equipped with tire pressure monitoring system, the tire repairing liquid for tire repair may result in the failure of the tire pressure monitoring system sensor. It is suggested to go the Aftersales Service Center for inquiries and repair.

**Internal Tread Wear Indicator**

Check the tire tread depth as per the tread wear indicator regularly. The mark on the tire wall indicates the position of the tread wear indicator.

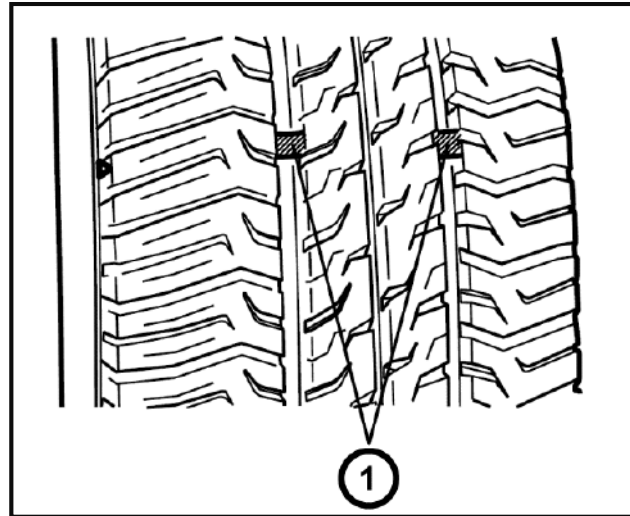

The tire must be replaced when the tread wear indicator appears. When the tread depth is equal to or less than 1.6 mm due to wear, the tread wear indicator will appear between the tread grooves.

**Caution**

**Do not drive the vehicle in case of tire wear or damage. The worn or damaged tires may lead to the vehicle out of control and cause collision accidents, resulting in personal injury and damage of vehicle or other properties.**

**Tire Rotation**

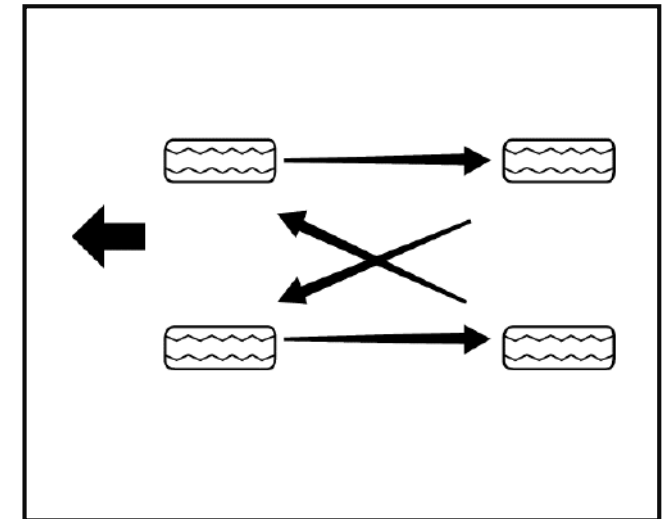

The front tires and the rear tires have different functions and therefore have different levels of wear. The front tires wear faster than the rear tires. In order to prolong the tire life and avoid uneven tread wear:

1. Conduct tire rotation as per maintenance regulations in the Manual.
2. Keep a proper tire pressure.
3. Check nuts/bolts for tightening.

**Caution**

Please use the recommended wheels and wheel nuts/bolts.

Otherwise, it may lead to the vehicle out of control and cause collision accidents, resulting in personal injury and damage of vehicle or other properties.

**Note**

If the vehicle is equipped with tire pressure monitoring system, after tire rotation or tire replacement, please go to the Aftersales Service Center to relearn the tire pressure.

**Winter Tire**

The use of winter tires while driving on icy and snowy roads can improve driving safety. It is suggested to replace with winter tires when the temperature is below 7 °C. Please select winter tires with radial tire structure and use such winter tires on all four wheels. Please use the specified tire pressure. Do not drive the vehicle at a speed exceeding the maximum speed specified by the tire manufacturer. All-weather tires can be used except winter tires.

**Tire Chain**

Tire chains are only used for emergencies or in areas clearly defined by law and should be installed on the drive wheels. Be especially careful when driving the vehicle equipped with tire chains. Compared with tires without tire chains, when tires are installed with tire chains, the maneuverability of the vehicle is poor, and the tire chain may damage the vehicle tire, suspension or vehicle body. Therefore, use cable tire chains as far as possible to ensure enough space between the tire and other parts in the wheel casing. When using tire chains, carefully read the installation and other related instructions of the tire chain manufacturer.

**Note**

After installation of tire chains, it is suggested to drive the vehicle at the speed of below 30 km/h or the limited speed recommended by the tire chain manufacturer (whichever is smaller).

**Spare Tire, Jack and Tools****Tool Kit****5-seat Model**

The spare tire, jack and tools are under the luggage compartment and can be seen after raising the luggage compartment floor. In-vehicle tools include the jack rocker, socket wrenches, traction hooks and screwdrivers.

**7-seat Model**

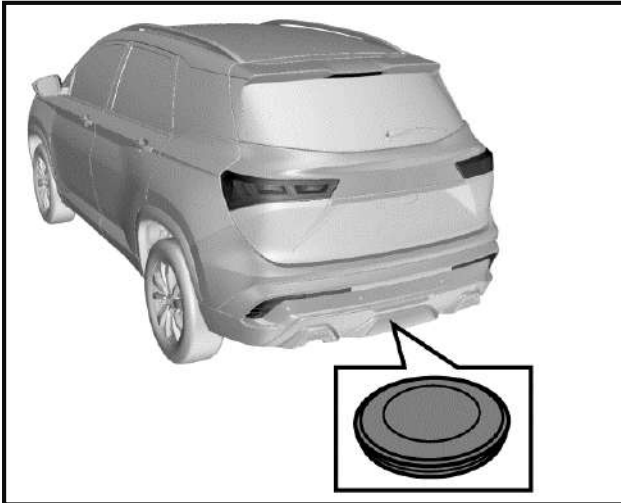

The spare tire of 7-seat model is at the bottom of the vehicle rear floor. The jack and tools are in the luggage compartment.

**Spare Tire**

Although the spare tire has been inflated, it will leak after a period of time. It shall check the inflation pressure regularly. Refer to the tire load information label for the correct inflation pressure.

Do not use the spare tire for other vehicles. Do not mix spare tires or wheels with wheels or tires of other vehicles since they are not matched. The spare tire should be put together with its wheel.

**Safety Precaution of Tire Replacement:**

1. Turn on hazard warning lamp.
2. Drive off the highway to a safe place without traffic.

3. Park the vehicle on a flat and hard surface where the vehicle will not slip. Take out the warning triangle and place it at a proper position behind the vehicle (please comply with traffic rules).
  4. Turn off the engine and remove the key.
  5. Place the gearshift lever at Gear 1 or reverse gear. Pull up the parking brake.
  6. Have all passengers leave the vehicle and stand in a safe place.
  7. Secure the tire that is diagonal to the tire that need to be replaced with wedges, blocks or stones.
- Failure to comply with these safety precautions may cause your vehicle to slip off the jack, thus causing serious injury.

**Take out the Spare Tires  
5-seat Model**

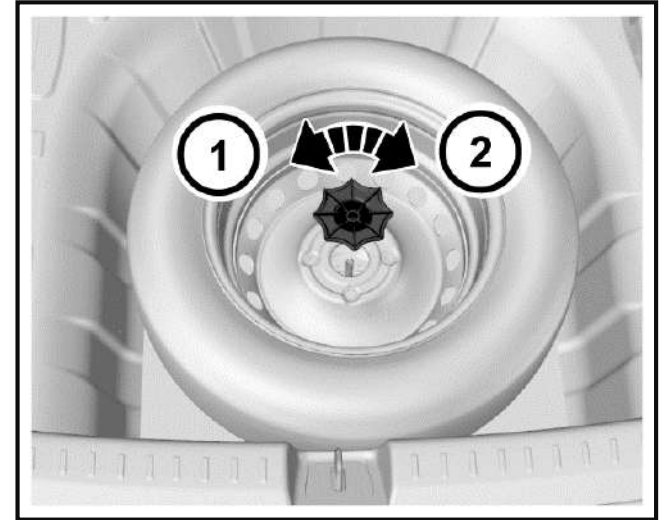

1. Open the liftgate and raise the luggage compartment floor.
2. Take out the tool bracket on the spare tire. If the audio is equipped, disconnect its cable.
3. Rotate the butterfly nut in the center of the spare tire counterclockwise to remove it, and then place it properly.
4. Take out the spare tire.

## 7-seat Model

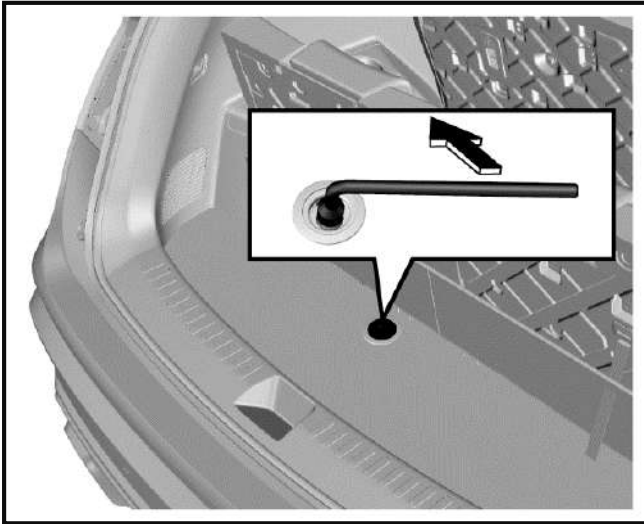

1. Open the liftgate and remove luggage compartment floor mat. As shown in the figure, there is one bolt on the storage box bottom board that serves as the shaft of spare tire lifter.
2. Use a wheel nut wrench to rotate the shaft counterclockwise until the spare wheel lowers to the ground.

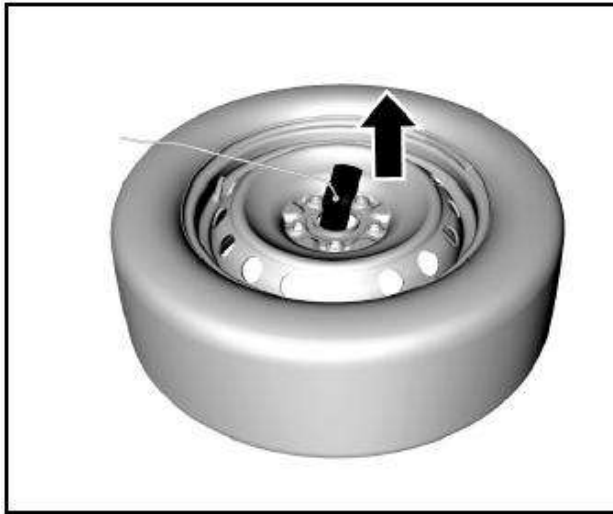

3. Tilt the holding plate at the end of wire rope and pull it out of the center hole of the wheel.

## Spare tire reassembling procedures:

1. Have the spare tire valve to face upwards and then tilt the holding plate at the end of wire rope to make it pass the center hole of the wheel.
2. Use a wheel nut wrench to rotate the shaft clockwise until the spare tire is lifted off the ground.
3. Check whether the holding plate holds the spare tire securely.
4. Continue to raise the spare tire until it is tight against the lower part of the vehicle. The wire rope is tensioned moderately but not too tightly to guarantee that it can hold the spare tire firmly.
5. Try to turn the spare tire to check that it is secured. If the tire is movable, it is necessary to further tighten the lifter shaft.
6. Put tools and the jack back into the tool kit.

## Jack Lifting Point

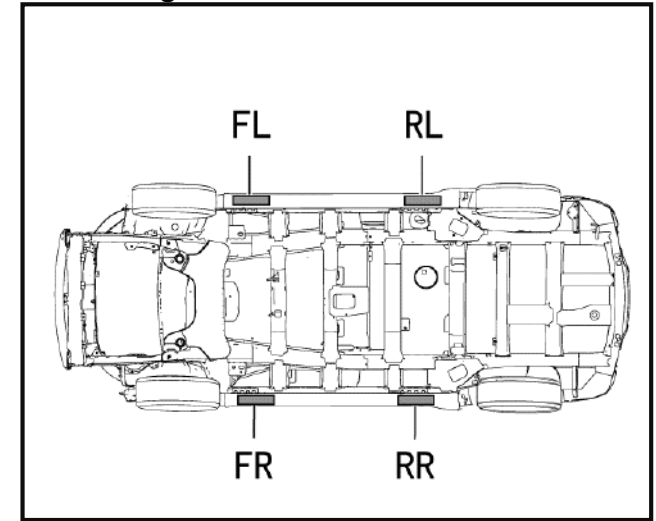

As shown in the figure above, the jack lifting points are around the side wall skirt, and there are triangle marks in corresponding parts for the convenience of searching. These lifting points are also lifting points of the lifter, and the lifter tray should be aligned with the triangle mark. The lifting points have been specifically strengthened. Please be sure to align them.

### Tire Replacement

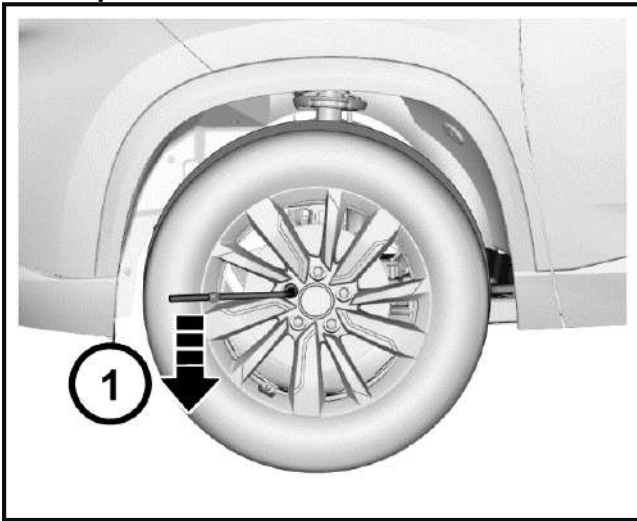

1. Take out tools, the jack and spare tire. Check and confirm that the tire on the diagonal is secured with blocks or stones.
2. Use a socket spanner to unscrew the wheel nut by one turn.

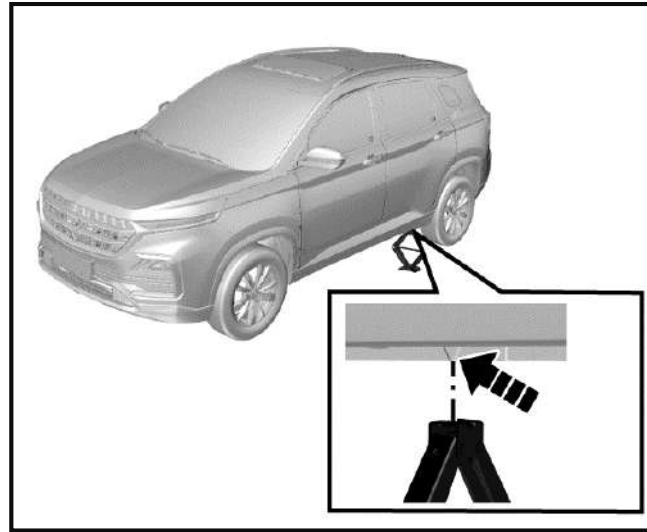

3. Place the jack just below the lifting point closest to the tire that needs to be replaced. Align the slot on the jack head with the edgefold.

**Caution**  
**Do not remove any nut before wheels are lifted off the ground.**

**Warning**  
**Do not attempt to lift the vehicle before the jack is put into a proper position. The jack should be firmly secured between the vehicle and the ground.**

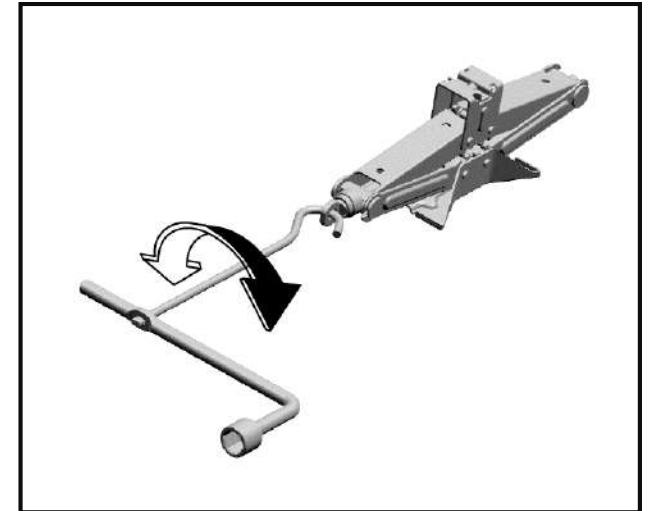

4. As shown in the figure above, connect the jack rocker to the jack.
5. Rotate the rocker clockwise to allow the jack to rise slowly and ensure that the jack head is firmly pushed into the lifting position.
6. After ensuring that the jack is in the correct position, continue turning the rocker until the tire is about 3 cm off the ground.
7. Place the spare tire at the vehicle bottom near the wheel to be replaced so as to prevent the vehicle from suddenly slipping.
8. Remove wheel nuts completely.
9. Remove the wheel to be replaced.
10. Install the spare tire on wheel hub.



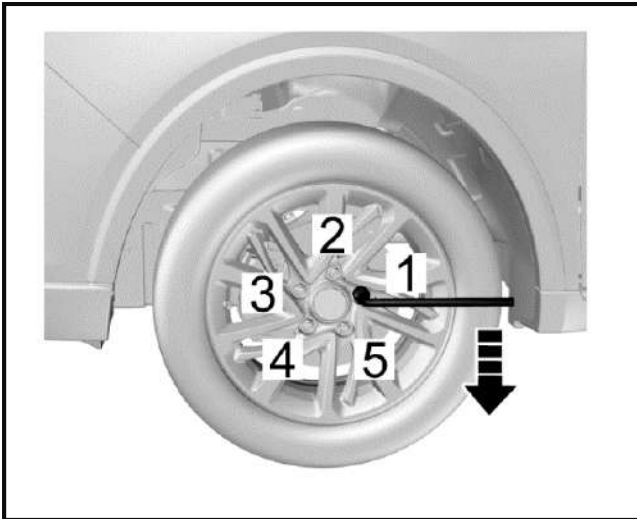

11. Install all wheel nuts and tighten them preliminarily.
12. Rotate the jack rocker counterclockwise to lower the vehicle to the ground stably.
13. Tighten the wheel nuts in the order 1-4-2-5-3 as shown in the figure above with the torque of 100~130 N·m.
14. Put the leaky tire in the spare tire storage location and secure it properly. Put tools back to the tool kit and secure them.

#### Caution

Make sure to use appropriate nuts and bolts, and tighten to the proper torque. The use of incorrect parts or improper tightening of vehicle nuts may cause damage to the vehicle or wheel falling off.

#### Caution

During the entire process the vehicle being lifted by the jack, ensure that the jack is placed vertically and no slipping occurs.

#### Note

Do not lift the vehicle to a height that exceeds the necessary height for wheel replacement.

#### Note

Please replace the leaky tire as far as possible for further use. It shall check the spare tires regularly to ensure that they can be used safely in case of emergency.

#### Caution

Do not work under the vehicle or start the engine when the vehicle is supported by a jack. The vehicle may slip off the jack, resulting in serious injury or death.

#### Note

When the vehicle jacking condition is unsatisfactory or if you do not have the confidence to safely complete this work, please contact the Aftersales Service Center for help.

#### Caution

Do not apply oil or grease on the wheel nuts or bolts. Please use correct wheel nuts or bolts. Use a socket wrench to tighten nuts or bolts firmly. Please go to the Aftersales Service Center as soon as possible and tighten wheel nuts or bolts according to specification. In case of improper tightening, nuts or bolts may be loose, resulting in accidents.

**Caution**

When using the jack, the vehicle may become unstable and move, causing damage and personal injury. Please use the correct jack in normal state. Before lifting, have all passengers leave the vehicle and stay away from traffic. The jack is used for wheel replacement only. Do not jack up the vehicle on a sloped or sliding ground. Use the jack at the jack lifting point closest to the wheel that needs to be replaced. Stop the wheel on the diagonal with wedges, blocks or stones so as to avoid vehicle moving.

**Caution**

Before using the jack, make sure that the parking brake is pulled up, the transmission is at Gear 1 or reverse gear. Avoid replacing wheels at traffic-intensive locations.

**Jump Start (Dead Battery)**

The vehicle with a low battery can be started by using the battery of other vehicles by the means of jump start. If the battery is dead, please contact the Aftersales Service Center for handling unless you confirm that you have enough electrical knowledge and you can safely complete this work.

**Caution**

Do not start the vehicle by the means of pushing or dragging. Otherwise, it may damage the catalytic converter and the transmission and even personal injury.

**Preparation before Jump Start**

1. Pull up the parking brake.
2. Ensure that the gearshift lever is at the neutral.
3. Turn off all electrical accessories.

**Note**

Turn off the audio system before jump start of the vehicle. Otherwise, the audio system will be damaged. Please turn off unnecessary electrical devices when the vehicle is running at low speed for long time (in case of traffic jam).

**Jumper Cable Connection**

In case of jump start of the vehicle, connect the jumper cable in the following order:

1. Clip one end of the first jumper cable to the positive terminal of the powered battery. (There is a "+" mark on the battery housing or the terminal)
2. Clip the other end of the jumper cable to the positive terminal of the dead battery. (There is a "+" mark on the terminal)
3. Clip one end of the second jumper cable to the negative terminal of the powered battery. (There is a "-" mark on the battery housing or the terminal)
4. Connect the other end of the cable to the body ground of the vehicle that has no electricity.
5. While jump start, it is allowed to start the engine of the vehicle providing jump start power supply. Try to start the engine of the vehicle that has no electricity within one minute, and do not turn the ignition key more than 5s each time. After start, keep the rotation speed at 2000 (r/min) for several minutes.
6. To remove the jumper cable carefully in reverse order, remove the negative cable first and then the positive cable.

**Caution**

There is the risk of battery explosion. You may be burned by the battery acid, and an electrical short circuit can also cause personal injury or damage to the vehicle.

- Do not place the battery near an open flame or sparks. Do not tilt the vehicle body over the battery in case of jump start.
- Do not allow cable terminals to contact with each other.
- Wear safety goggles when working nearby the battery.
- Do not allow battery acid to come into contact with eyes, skin, fabric or painted surfaces.
- Ensure that the battery used for jump start has the same voltage as the voltage of original vehicle battery.
- Do not disconnect a dead battery from the vehicle.

When starting the engine with jumper cables, violation of the above precautions or the following instructions can cause the battery to explode, resulting in people being burned by battery acid or causing a short circuit. This may damage the electrical system of both vehicles and cause serious personal injury.

**Caution**

Position the jumper cable properly and do not wrap it around rotating parts of the engine compartment. Otherwise, it may damage the vehicle and cause personal injury.

**Caution**

It shall not be connected to the negative (-) terminal of the battery when it is finally connected to the vehicle that needs to be charged.

Connect the last connected clip to the bolt on the engine cylinder block steel bracket. The last connection point should be away from the battery as far as possible.

If the jumper cable is connected to the negative terminal of an uncharged battery, it may produce electric arc and cause the battery to explode. It will cause serious personal injury or damage the vehicle.

**Note**

It shall start the engine of the vehicle with a discharged battery at an interval of about 1 minute, and the time for each start cannot exceed 15s.

**Caution**

Do not use the battery as a jump source for other appliances for a long time. Otherwise, it is easy to make the battery lose electricity and may even cause safety accidents.

**Vehicle Traction**

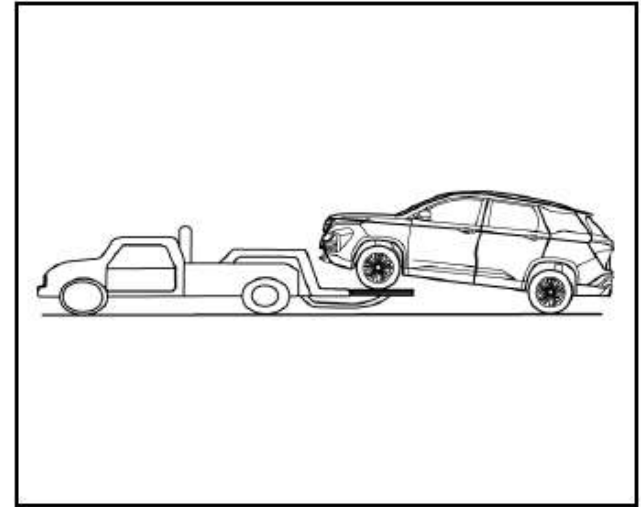

If vehicle traction is necessary, please contact the Aftersales Service Center or a professional traction service company.

**Note**

Do not tow the vehicle with lifting chain type equipment. It must use plates or wheel lifting equipment.

**Caution**

- It is prohibited to allow passengers to be seated in the towed vehicles.
- The towing speed is not allowed to exceed the safe speed or the indicated road speed limit.
- It is prohibited to use damaged parts that are not firmly secured onto the vehicle for traction. Failure to comply with the above precautions may result in personal injury.

**Vehicle Traction with Wheel Lifter**

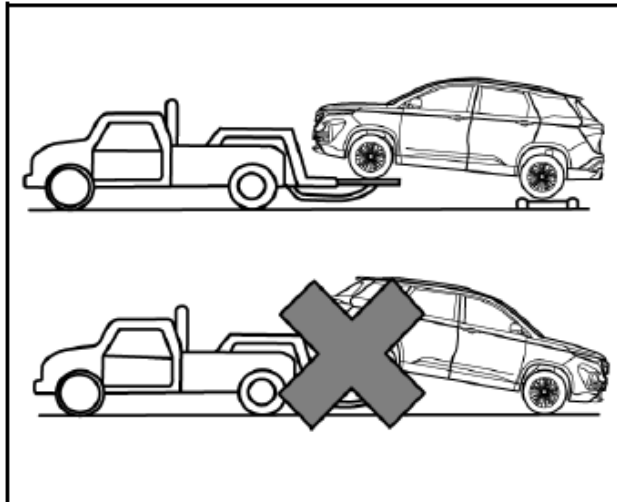

1. Turn on the hazard warning flasher.
2. Turn the ignition switch to ACC position.
3. The transmission must be in neutral gear.

4. Release the parking brake.
5. Front wheels must be off the ground when towing.

**Vehicle Traction with Platform Trailer**

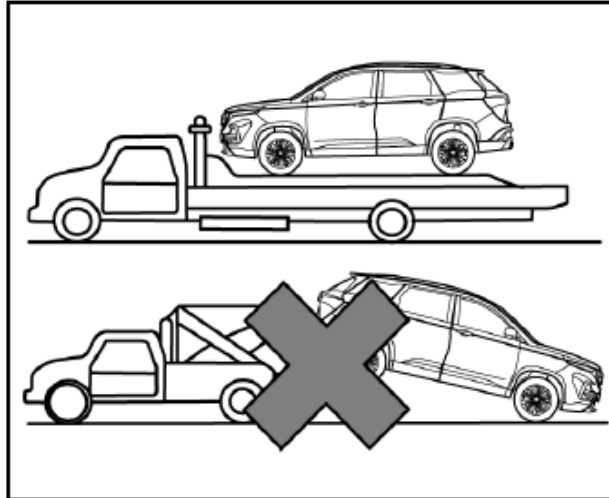

When towing the vehicle with a platform trailer, turn off the ignition switch and check that the vehicle is firmly attached to the trailer.

**Note**

**If the vehicle must be towed from the rear, please use traction device supporting wheels under the front wheels. The front wheels should not be on the ground when the vehicle is towed from the rear. Otherwise, it may cause serious damage to the vehicle transmission.**

**Emergency Trailer**

If the tractor is not available in case of an emergency, it can secure the rope on the front towing hook under the vehicle for temporary vehicle traction. When the vehicle is towed via the front towing hook, only traction rope can be used. Do not use a rigid tow bar.

No matter MT or AT model, engage the neutral (N) gear and release the hand brake when the vehicle is towed.

**Front Towing Hook**

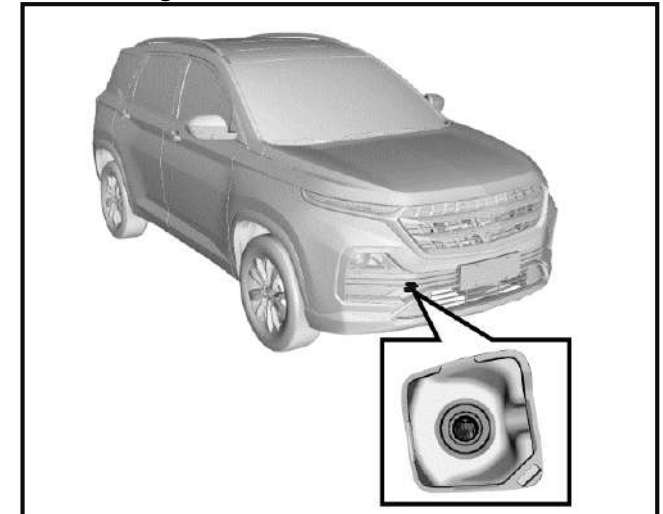

There is a hole cover on the right side of the front bumper of the vehicle. Open it and the fixing hole for hook installation can be seen.

The towing hook is on the tool bracket under the luggage compartment floor. Take out the towing hook and install it into the fixing hole. Rotate the towing hook clockwise to tighten it completely and insert a socket wrench into the hook hole to assist tightening. Be sure that the towing hook is installed firmly before towing the vehicle. When towing the vehicle, the driver must control steering and braking in the vehicle. After completion of traction, remove the towing hook and close the hole cover, and then put the towing hook back into the tool kit.

#### Rear Towing Hook

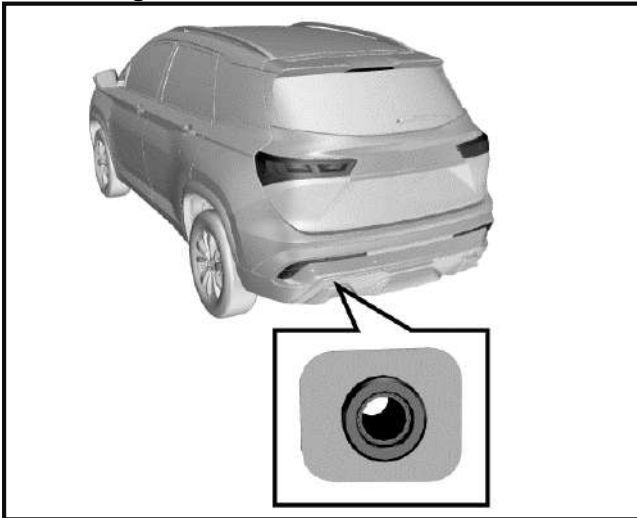

There is a hole cover on the left side of the rear bumper of the vehicle. Open it and the fixing hole for hook installation can be seen.

Take out the towing hook and install it into the fixing hole. Rotate the towing hook clockwise to tighten it completely and insert a socket wrench into the hook hole to assist tightening. Be sure that the towing hook is installed firmly before towing the vehicle.

Do not tow vehicles that are heavier than this vehicle; otherwise, it may damage the vehicle or cause accidents.

#### Note

The vehicle may be damaged when it is towed by ropes. To reduce damage:

- The towing hook must be used when other traction devices are not available.
- The vehicle shall be towed from the front only.
- Keep the traction rope out of contact with the bumper.
- Make sure that both ends of the traction rope are firmly secured on the towing hook. Pull the traction rope for inspection.
- Drive the vehicle at a low speed and avoid sharp turning.

#### Note

The vehicle may be out of control when it is towed by ropes.

To reduce damage:

- The towing distance shall not be too long, and the vehicle should be towed at a low speed.
- Do not tow the vehicle if the wheel, transmission, axle, steering or brake damage is damaged.
- Do not remove the key from the ignition switch; otherwise, the steering will be locked so that the vehicle cannot turn.

#### Caution

The towing speed shall not exceed 30 Km/h, and the towing distance shall not exceed 40 Km. When long-distance towing is required, it is suggested to contact the Aftersales Service Center or a professional towing service company for help.

### Getting Vehicle out of Trap

When the vehicle is caught in snow, puddle or other unstable ground, please follow the procedures below to get the vehicle out of trap.

1. Turn the steering wheel to the ultimate left and then turn it to the ultimate right. This will create a vacant area around the front wheels.
2. Engage the reverse gear and drive gear back and forth.
3. Reduce wheel idling as far as possible.
4. Release the accelerator pedal when shifting gear.
5. After engaging the gear, depress the accelerator pedal gently.

If it fails to get the vehicle out of trap, it is necessary to tow the vehicle.

#### Caution

**When the vehicle is caught in snow, puddle or sandy soil, you need to get the vehicle out of the trap as soon as possible.**

**First, check whether there are obstructions or people around the vehicle.**

**During operation, the vehicle may suddenly move forward or backward, hitting the person or object next to it.**

#### Note

**In order to avoid damage to the transmission and other parts, the following precautions must be observed when getting the vehicle out of the trap.**

**●Do not depress the accelerator pedal during gear shifting or when the transmission is not in a proper gear position.**

**●High engine speed is not allowed, and wheel idling shall be avoided.**

**●If it fails to get the vehicle out of trap after several efforts, consider other methods, such as traction.**

### Vehicle Maintenance

#### Cleaning Agent

The manufacturer's suggestions must be observed when using cleaning agent or other chemical products inside or outside the vehicle.

Do not use dangerous cleaning agent when cleaning the interior and exterior of the vehicle. For example:

- Acetone
- Paint diluent
- Porcelain glaze reducing agent
- Nail polish remover

When cleaning the interior and exterior of the vehicle, the following cleaning agents are prohibited unless special instructions for cleaning stains are included in the fabric cleaning tips:

- Laundry soap
- Bleaching powder
- Reducing agent

#### Caution

**Some cleaning agents are toxic, corrosive or flammable. Improper use is very dangerous and may easily cause personal injury or vehicle damage.**

Do not use the following materials for cleaning:

- Carbon tetrachloride
- Gasoline
- Benzene
- Naphtha

When using any cleaning agent or other chemical products inside the vehicle, please open the doors for proper ventilation.

To avoid permanent color change of light-colored interior trims, do not allow the easy-to-discolor fabrics to come into contact with the seat liner unless both materials are completely dry. Fabrics with easy-to-discolor materials are:

- Casual clothes
- Dyed denim
- Leather
- Kidskin
- Newspapers and decorative paper

**Caution**

**Avoid prolonged exposure to cleaning agents and other chemical vapors. Such chemical vapor is extremely dangerous and harmful to the health, especially in limited space without ventilation.**

**Vehicle Interior Maintenance and Cleaning**

Clean the interior and exterior of the vehicle with proper cleaning methods and materials.

Use a vacuum cleaner or a banister brush to remove dust and scum that accumulate on the fabric inside the vehicle frequently.

Wipe the vinyl plastics and leather trims regularly with a clean wet cloth.

Remove dust, spots or stains on trims with a suitable cleaning agent.

**Note**

**Clean the interior trims of the vehicle with proper cleaning methods and materials. Otherwise, it will produce water spots, watermarks and permanent spots, especially during the first washing. These substances will permanently damage the vehicle.**

**Seat Belt Maintenance**

Keep the seat belts clean and dry. Prevent seat belts from being contaminated by polishing agents, oils and chemical products, especially battery fluid, bleaching powder or dyestuff. These contaminants will reduce the strength of the seat belt material. Check all seat belt parts regularly. Replace any damaged seat belt or part immediately.

The seat belt or related parts that are stretched during the accident must be replaced, even if the damage is not obvious or is not visible. The seat belt for replacement must be new.

**SGMW** suggests replacing the whole seat belt assembly after collision. It is not necessary to replace the seat belt after it is checked to be undamaged and normal by the Aftersales Service Center for solution.

**Note**

**The seat belt must be kept in good working condition to maintain its normal function.**

**Glass Surface**

Make sure that the window glass is clean, which helps reduce glare and improve vision.

**Front Windshield Outside Cleaning**

Waxes or other materials on the front windshield and blade may cause the blade to shake when working. Moreover, such foreign matters are not conducive to keeping the front windshield clean. Clean the outside of the front windshield regularly with a non-abrasive cleaning agent.

Water does not form water droplets on the clean front windshield.

**Note**

**The non-abrasive cleaning agent will scratch the glass and damage the rear windshield defroster grid lines. Do not use abrasive cleaning agent on vehicle glass. Otherwise, it will affect the driver's vision.**

**Note**

**Decals will affect the rear windshield defroster. Do not paste decals on the inner side of the rear windshield. Otherwise, it will affect the driver's vision.**

**Vehicle Exterior Maintenance and Cleaning****Vehicle Washing**

The best way to maintain the finish paint of vehicles is to wash it regularly and keep it clean.

- Park the vehicle in the place where is not directly exposed to sunlight.
- Wash the vehicle with the specified neutral soap liquid and cold or warm water.
- Be sure to remove the soap liquid and cleaning agent from the surface by the means of flushing.

**SGMW** vehicles are designed to operate under normal environmental conditions and natural factors.

**Note**

**Do not use household dishwashing detergent to wash the vehicle. The dishwashing detergent can wash off paint and wax.**  
**Avoid excessive vehicle washing pressure. Water may enter the vehicle and damage the interior.**

**Polishing and Waxing**

Regular polishing can remove residues from the surface of the vehicle. After polishing, use high-quality car wax for protection.

**Note**

**It is forbidden to clean or polish aluminum trims with automotive or chrome polishing agent, steam or alkaline soap liquids. These substances are abrasive and may damage trims and wheels.**

**Exterior Bright Metal Parts Protection**

Clean the bright metal trims regularly. They are usually washed with water. When waxing the vehicle, please also wax these bright metal parts.

**Aluminum Wheels and Wheel Trim Cover Cleaning**

To maintain the original appearance of the wheel and wheel trim cover (if any), do not allow them to collect dust or brake dust.

Clean the wheel/wheel trim cover regularly. Do not use abrasive cleaning agent or brush that may damage the finish paint.

**Note**

**Do not use abrasive cleaning agent or brush to clean aluminum wheels or wheel trim covers.**

**Corrosion Prevention**

**SGMW** vehicles are designed to have anti-corrosion capabilities. The use of special materials and protective paint on most vehicle parts helps maintain satisfactory appearance, strength and reliability.

Although the surfaces of certain parts inside the engine compartment or of the underbody may rust, the reliability or performance of these parts will not be affected.

**Metal Plate Damage**

If the body needs to be repaired or replaced, ensure that the repair shop uses proper anti-corrosion materials to restore the anti-corrosion protection performance.

**Foreign Matter Deposition**

The following substances may damage the paint surface:

- Calcium chloride and other salts
- Ice melting agent
- Road surface oil and asphalt
- Sap
- Bird droppings
- Industrial dust

Remove harmful substances on the vehicle in time. If residues cannot be removed with soap liquid, a special cleaning agent can be used.



**Finish Paint Damage**

Repair the gravel scratches, cracks or deep scratches on the finish paint as soon as possible. Exposed metal is prone to corrosion. Quick-drying products can be used to repair tiny cracks and scratches. Body and paint repair shops can complete large-scale repairs.

**Note**

**Only safe cleaning agents that are harmless to the paint surface can be used.  
Other cleaning agents may permanently damage the paint.**

**Underbody Maintenance**

Corrosive substances used for ice and snow melting and dust prevention may accumulate at the underbody. Failure to remove these substances will accelerate corrosion and rusting.

Flush the underbody with clean water regularly. Clean the part where the mud is prone to accumulate carefully. Loosen the accumulated dirt in the enclosed area before flushing with water.

When necessary, please contact the Aftersales Service Center for service.

## Technical Data

Vehicle Identification.....	163
Vehicle Identification Number (VIN) .....	163
VIN on Instrument Panel.....	163
VIN Rubbing Seal under Engine Hood.....	163
Vehicle Identification Plate.....	163
VIN Label under Liftgate .....	163
Seal Engine Number.....	164
Method for Reading Vehicle Identification Number Information from ECU .....	164
Vehicle Data .....	165

### Vehicle Identification

#### Vehicle Identification Number (VIN)

There are 4 commonly used VIN marks on the vehicle.

#### VIN on Instrument Panel

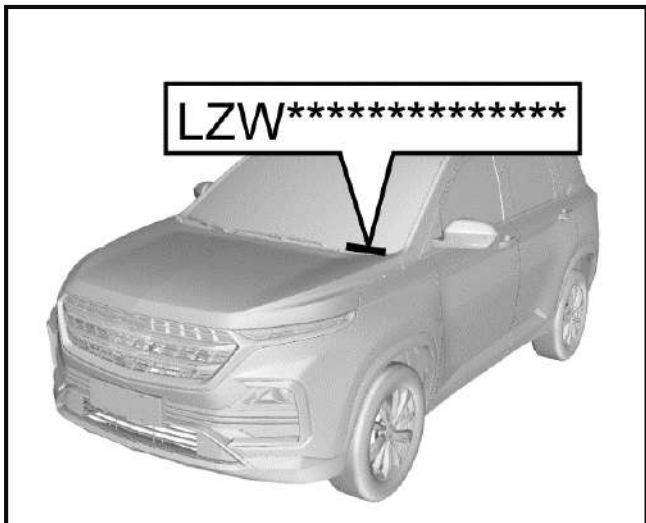

It is the legal identification mark of the vehicle. The VIN is at the front corner of instrument panel at the driver's side. It can be seen from the outside via the front windshield.

#### VIN Rubbing Seal under Engine Hood

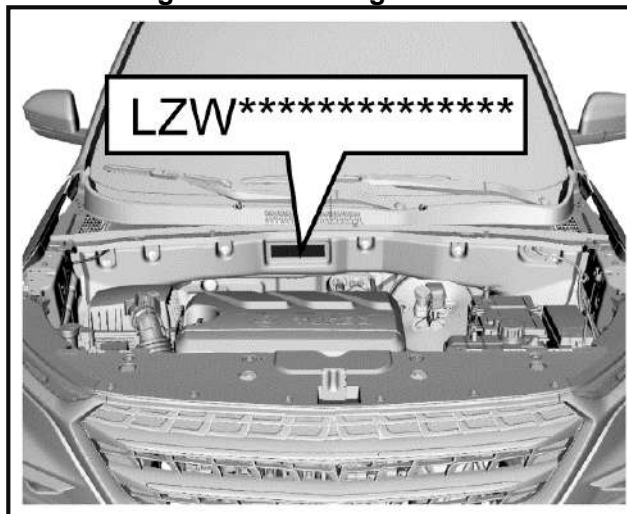

It is located under the engine hood below the wiper.

#### Vehicle Identification Plate

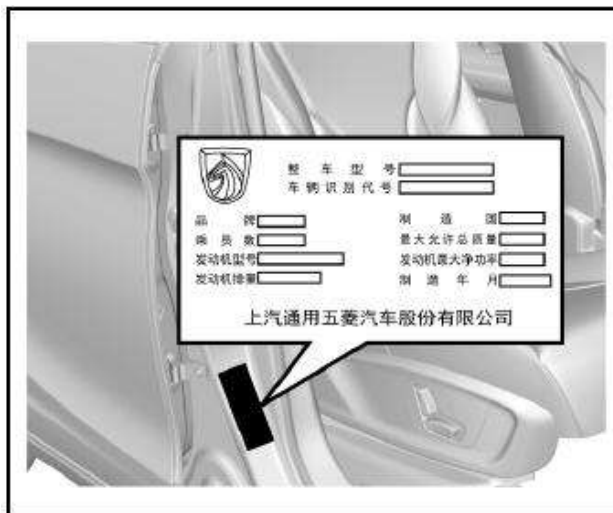

This plate is a paper plate and is located on the door frame at the front passenger side.

#### VIN Label under Liftgate

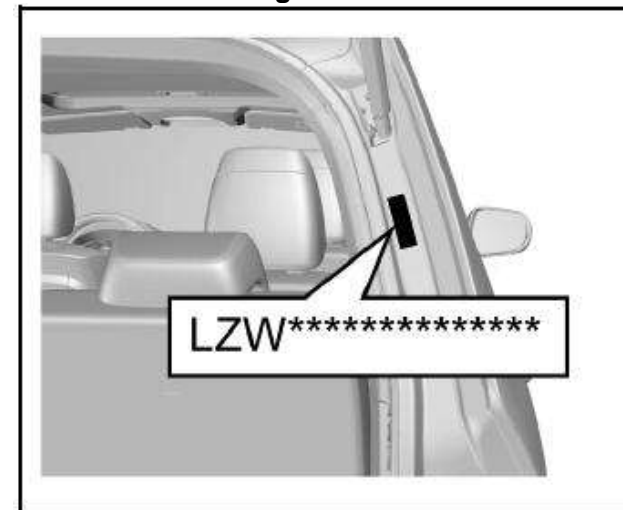

Open the liftgate, and it can be seen that the label is below the liftgate strut support on the right side.

## Seal Engine Number

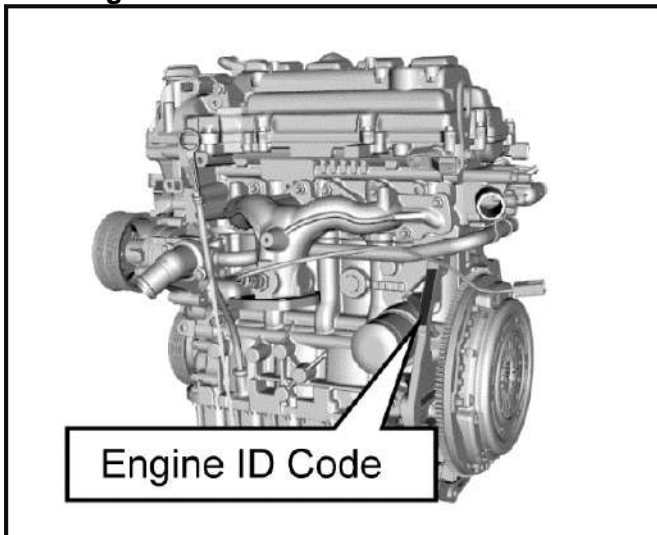

It is on the engine cylinder block near the flywheel.

### Method for Reading Vehicle Identification Number Information from ECU

#### Method I: Use X431 Diagnostic Scanner

1. Connect the X431 diagnostic scanner with CAN BUS II interface to the on-board OBD interface that is generally located below the instrument panel at the driver's side.
2. Turn the vehicle power supply to ON position and turn on the power of the diagnostic scanner.

3. Click the "Start" button of X431 diagnostic scanner to enter "Diagnostic Program" and select "Vehicle Decoding Program" and "Start", and then, select the corresponding series. Select the latest diagnostic software version, click "OK" and wait for the device to reset and click "OK" again. Select the corresponding model, "Engine Control System" and the corresponding electronic control system and then click "OK". Select "Version Information" to display the VIN.

#### Method II: Use WDS Diagnostic System

1. Connect the data cable of diagnostic system to the on-board OBD interface that is generally located below the instrument panel at the driver's side.
2. Turn the vehicle power supply to ON position and turn on the diagnostic system.
3. Select "Fault Diagnosis" to select the corresponding model. Click to enter "ECM", click "Module Identification Information" and select "VIN" to display the VIN.

Note: The methods for reading VIN with diagnostic equipment of different brand or model may be different. Please consult the equipment supplier.

## Vehicle Data

## Main Engine Performance Parameters

Item	Unit	Parameter
		Engine model: LL5
		Transmission model: F625A1, F625A, SH20M6B1, SH20M6B2
Engine type	—	c) Four-stroke, water-cooled, in-line, 16-valve, dual overhead camshaft, DVCP (dual variable CAM phase), timing chain drive, turbocharging, electronically controlled gasoline injection, electronically controlled ignition.
Cylinder diameter x travel	mmxmm	73.8x84.7
Displacement	L	1.451
Compression ratio	—	9.5:1
Rated power/speed	kW/(r/min)	110/5500

**Main Engine Performance Parameters (Continued)**

Maximum net power/speed	kW/(r/min)	102/5500
Maximum torque/speed	Nm/(r/min)	230/(2000~3800)
Complete vehicle quality	kg	118±2
Idle speed	r/min	750±50
Driving type	—	Front-engine front-drive
Fuel type and grade	—	92# and above motor gasoline
Complete vehicle emission standard	—	<ol style="list-style-type: none"> <li>1. The measuring method for vehicle loaded mode emission should comply with provisions of GB 18352.5 and DB 11/946.</li> <li>2. The vehicle model is shown on the vehicle identification plate. The penultimate letter represents the emission level; the letter “Y” represents the National V II Phase standard, and the number “6” represents the National VI standard. Example: For the vehicle model “LZW6477BMYZ”, the penultimate letter “Y” refers to the National V II Phase standard.</li> </ol>

## Main Quality Parameters of Complete Vehicle

Item	Unit	Parameter	
		LZ-W6477-BMYZ	LZ-W6477-BMVYZ
Seats	Person	7	5
Curb weight	kg	1541	1435,14-90
Front axle load of curb weight	kg	870	840,870
Rear axle load of curb weight	kg	671	595,620
Total mass	kg	2000	1850
Front axle load	kg	1000	930
Rear axle load	kg	1000	920

**Power Performance Parameters**

Item	Unit	Parameter	Testing method
		LZW6477BMYZ/ LZW6477BMVYZ	
Maximum vehicle speed	Km/h	≥170	GB/T 12544—2012
Maximum climbing gradient	%	≥30	GB/T 12539—1990



**Main Liquid Parameters**

Name	Trade mark	Capacity, unit unmarked: L
		LZW6477BMV- YZ/ LZW6477BMYZ
Motor gasoline	92# and above motor gasoline	52
Engine lubricating oil	SM/GF-4 5W-30	4.0
Transmission fluid	SAE 75W/90	2.0±0.15
Coolant	Ethylene glycol antifreezing fluid	7.1~7.6
Brake fluid (including hydraulic clutch fluid)	DOT4	0.45±0.05
A/C refrigerant	HFC-134a	570±20g

## Main Technical Parameters of Complete Vehicle

Item	Unit	Parameter	
		LZW6477BMVYZ	LZW6477BMYZ
Total length	mm	4655	
Total width	mm	1835	
Total height (no load)	mm	1760	
Wheel base	mm	2750	
Front suspension	mm	950	
Rear suspension	mm	955	
Front wheel track	mm	1554	
Rear wheel track	mm	1549	
Approach angle (no load/full load)	.	20/19	
Departure angle (no load/full load)	.	23/20	22/18

**Main Technical Parameters of Complete Vehicle (Continued)**

Minimum ground clearance (full load)	mm	185
Minimum turning diameter	m	11.9

**Name and Position of Parts not Included in Vehicle Overall Dimensions as Required by GB1589**

Name	Position
Wiper and washer	Vehicle rear end
Exterior identifications, including the product trademark, company name identification and other identifications that reflect vehicle characteristics	Vehicle front end, rear end and vehicle side
Lighting and optical signal device	Vehicle front end, rear end and vehicle side
Rear identification plate (with LOGO)	Vehicle rear end
Detachable vehicle hooking or dragging device	Vehicle front end and rear end
Exhaust tail pipe	Vehicle rear end
Indirect vision device	Vehicle front end, rear end and vehicle side
Anti-collision rubber block and similar devices	Vehicle side
Flexible protrusion of spray-suppression system	Vehicle side
Handle and switch	Vehicle side

**Name and Position of Parts not Included in Vehicle Overall Dimensions as Required by GB1589 (Continued)**

Deformed portion of the tire wall right above the tire contact point	Tire side
Soft part of the antenna	Roof

Note: Refer to the national standard GB1589 for details of the unlisted parts.

**Tire Inflation Pressure (Cold State)**

Tire model	Item	Tire inflation pressure (unit: kPa)	
		No-load	Full-load
215/60R17	Front tires	230±10	230±10
	Rear tires	230±10	230±10

**Wheel Alignment Parameters (No Load)**

Item		Range (unit: degree)	
		Vehicle model equipped with twist beam semi-independent rear suspension	Vehicle model equipped with independent rear suspension
Front wheel	Camber	-0°26'±45'	
	Kingpin caster angle	4°17'±45'	3°58'±45'
	Toe-in	0°±5'	
	Kingpin inclination angle	12°29'±1°	
Rear wheel	Camber	-1°±45'	-1°10'±45'
	Toe-in	11'±20'	10'±15'

**Fuel Economy Parameters**

Item	Unit	Requirement	Requirement	Test methods
		LZW6477B- MYZ	LZW6477B- MVYZ	
Fuel consumption under general operating condition	L/100 km	≤7.0	≤6.9	GB/T 19233—2008

**Other Parameters**

Item	Parameter
Requirement for dynamic balance of wheels	Dynamic unbalance value<15 g
Reasonable range of brake pedal free travel	<30 mm
Minimum scrapping thickness of front brake disc	24 mm
Minimum scrapping thickness of front brake lining	2 mm
Minimum scrapping thickness of rear brake disc	8.75 mm
Minimum scrapping thickness of rear brake lining	2mm



## Accessory List

Accessory List .....	178
In-vehicle tools .....	179

**Accessory List**

S/N	Name	Quantity	Remarks
1	Motor Vehicle Factory Certificate	1	
2	Vehicle Consistency Certificate	1	
3	Owner's Manual of Vehicle Audio System	1	Distribute according to vehicle configuration
4	In-vehicle package (including Service & Maintenance and Owner's Manual and Owner's Operation Manual)	1	
5	In-vehicle tools	1	
6	Warning triangle	1	
7	Mobile ashtray *	1	Distribute according to vehicle configuration
8	Reflective vest	1	Distribute according to regulatory requirements and put it in the glove box. When you need to get off the vehicle in an emergency, wear a reflective vest first.

**In-vehicle tools**



- 1. Jack
- 2. Jack rocker
- 3. Screwdriver
- 4. Wheel nut wrench
- 5. Towing hook

## Maintenance Procedures

Important Information .....	181
Warranty.....	182
Quality Assurance Service Regulations .....	182
Maintenance.....	186
Maintenance Purpose .....	186
Product Defect Report.....	207
Inquiry Way of Aftersales Service Center Contact	错误!未定义书签。

## Important Information

1. We suggest you to go to the Aftersales Service Center for vehicle maintenance and repair since that only the center knows your vehicle best. You will be provided with original accessories and professional technical services at the center. Quality can only be guaranteed by the center. Non-household vehicles (such as vehicles used by units etc.) are provided with services within the warranty period, and the household vehicles are provided with services within warranty period and "three guarantees" period.
2. The Company is not responsible for any problem caused by the use of non-original parts and components (including but not limited to the non-compliance of environmental emissions due to the use of non-original parts and components or other violations of laws and regulations).
3. For those who fail to perform regular maintenance at a service center during the quality assurance period, the quality assurance service is not provided to the contents related to maintenance and the fault caused consequently. A new vehicle can enjoy free maintenance (including material fees and man-hour fee) for the first time after it has been driven for 3 months or 5000 km (whichever comes first). This maintenance must be carried out by a service center with the owner holding the purchase invoice and this Manual.
4. The Manual must be shown to the service center during maintenance or repair. Be sure to keep this Manual and the maintenance and repair information recorded in the Manual properly. They are an important basis for you to enjoy the quality assurance service and for the service center to analyze the cause of the failure. The Maintenance Record Form must be stamped with the seal of the service center. The service center does not have the right to receive and keep the Manual. For vehicles that meet the quality assurance service conditions, the service center shall not refuse to provide quality assurance services for any reason.
5. In the case that the user submits a written return or transfer request, after the final appraisal and confirmation by SAIC GM Wuling Automobile Co., Ltd., the dealer can handle the return or transfer procedures and charge compensation fee based on the purchase price (the invoice of the sales unit shall prevail). And use mileage to collect compensation fees. Calculation formula:  $[(\text{vehicle price (RMB)} \times \text{total mileage (km)})/1000] \times 0.8\%$ .
6. After the driver leaves the vehicle, do not store valuables in the vehicle. Otherwise, the Company will not assume responsibility.
7. If you need help, please contact the nearest service center or call SAIC GM Wuling Automobile Co., Ltd. Service hotline: 400-86-12345, 400-889-5050; e-mail: [sales@sgmw.com.cn](mailto:sales@sgmw.com.cn)
8. The time or mileage in this Manual whichever comes first shall prevail. It will no longer be explained particularly if there is no necessary.
9. Any matters not covered in this Manual and those that are inconsistent with the relevant national laws and regulations shall be subject to the relevant national laws and regulations.

## Warranty

### Quality Assurance Service Regulations

1. After vehicle defects caused by product design, manufacturing, assembly, raw material defects and other factors during the quality assurance period being identified by SAIC GM Wuling Automobile Co., Ltd., to protect the environment protection and sustainable development, it is mainly repair defective parts for free. In the case that defective parts cannot be repaired or have no repair value, the repair method of parts replacement shall be adopted. The parts and components used for repair or replacement are provided by the manufacturer or are qualified by inspection.
2. Within the quality assurance period, if the vehicle needs to be repaired due to defects in the scope of the quality assurance service, please allow the service center to have sufficient time to make necessary repairs. The service center will return your vehicle as soon as possible, and the replaced parts are owned by the Company.
3. Except for mandatory regulations of Chinese laws, the quality assurance service provided by this Manual is the sole responsibility of the Company to owners.
4. The transportation time of special parts and components and the time taken to go out for rescue are not included in the maintenance time. For the definition of special parts and components, please refer to the appendix of the appendix of the Three-guarantees Certificate.
5. Non-household vehicles (such as vehicles used by units etc.) are provided with services within the warranty period, and the household vehicles are provided with services within warranty period and "three guarantees" period.

### Owner's Rights and Obligations

For the new vehicle parts and accessories at own expense, the Owner has the right of being provided with quality assurance service under the precondition of fulfilling the basic obligations while complying with other relevant provisions of this Manual. The following are the basic obligations that the Owner needs to perform in order to obtain the right of enjoying quality assurance service:

1. Within the quality assurance period, perform regular maintenance at the service center as specified and correctly use and operate according to the regulations in this Manual.
2. Use original accessories provided by the Company; carry out maintenance, repair and replacement at the service center and provide valid certification.
3. To ensure the safety of the Owner and the vehicle, for the faulty vehicle, the Owner should keep its original status and contact SAIC GM Wuling Automobile Co., Ltd. or a service center as soon as possible. Do not disassemble or repair the vehicle by yourself without the permission of SAIC GM Wuling Automobile Co., Ltd. or a service center.

### Quality Assurance Service Scope

1. Defects within the quality assurance service scope: refer to vehicle defects caused by product design, manufacturing, assembly, raw material defects and other factors during the quality assurance period being identified by SAIC GM Wuling Automobile Co., Ltd.

2. Within the quality assurance period, material fees and man-hour fee incurred by vehicle maintenance due to defects within the scope of the quality assurance service will not be charged to the Owner.
3. Supplementary material fees (e.g. engine oil, transmission fluid and brake fluid etc.) that are incurred due to quality assurance service will not be charged to the Owner.

### Conditions not Included in Quality Assurance Service Scope

1. Use for rent or operation;
2. Forging or illegal obtaining of relevant vehicle purchase certificate and in-vehicle manual data etc.;
3. Failure to provide purchase certificate when the information about vehicle purchase is required;
4. The Manual being shown beyond the quality assurance period or not shown, or failure to provide relevant certificate for re-applying this Manual, or failure to simultaneously show the Manual, purchase invoice and settlement issued by the service center for self-paying accessories;
5. Failure to completely fulfill basic obligations of the Owner;
6. Faults caused by changes to the original vehicle structure, including assembling, refitting or adding equipment without permission;
7. Cheating during the quality assurance period, including but not limited to deliberate changes to the odometer;
8. Refusing quality assurance services from SAIC GM Wuling Automobile Co., Ltd. or the service center;

9. Secondary failures caused by continuous driving when the vehicle is faulty, including but not limited to the damage caused by continuous driving when the coolant temperature gauge indicates high temperature;
10. Product failure or missing of parts due to improper use, storage or maintenance by the Owner, including but not limited to failure of engine or electrical equipment and other parts and components due to vehicle wading, or faults caused by theft, overloading, abnormal control, racing, exposure to the sun and long-term parking, etc.;
11. Damages due to traffic accidents, natural disasters or other force majeure, including but not limited to car accident, floods, sandstorms, earthquakes, hail, mudslides and military operations etc.;
12. Maintenance materials to be replaced regularly for maintenance except for the first maintenance, e.g. oil and filter element etc.;
13. Defects caused by human or external factors, e.g. damage, rusting, fading and scars etc., including but not limited to foreign body scratches, animal excrement contamination and environmental pollution etc.;
14. Symptoms that are no perceived effects on the quality or function of the vehicle under normal circumstances, including but not limited to minor noise or vibration;
15. Economic loss or additional expenses caused by improper use of the vehicle, e.g. loss of time, personal property and income.

**Quality assurance period**

The quality assurance period is divided into original vehicle parts quality assurance period and self-paying accessories quality assurance period according to the parts. The former is divided into the warranty period and “three guarantees” period according to the nature; the latter only consists of the warranty period. The quality assurance period does not change with the ownership of the vehicle. However, if there is any other agreement between the sales unit and the Owner, the signed agreement shall prevail, and in such case, relevant policies and provisions of this Manual will not apply, e.g. the second-hand vehicle trading agreement, agreement related to inventory cheapened vehicles and relevant agreements of defective vehicles. The quality assurance period is specifically defined as follows:

1. **Original vehicle parts quality assurance period:** It refers to the quality assurance period for the original vehicle parts when purchasing a new vehicle from the date of purchase (based on the invoice issued by the sales unit) and the mileage at this time. The Three-guarantees Certificate will indicate the date of purchase and be signed by the Owner. The original vehicle parts quality assurance period is divided into the warranty period and “three guarantees” period according to the time. Refer to the appendix of the Three-guarantees Certificate for details. The Owner should present this Manual to the service center when requesting the original vehicle parts quality assurance service. If the odometer fails or is damaged and has not been repaired in time, resulting in failure to confirm the mileage, the accumulated mileage will be calculated as 300 km/day from the date of purchase. If there is a record of quality assurance service, it will calculate as 300 km/day from the date of repair, and the mileage will be accumulated along with the mileage recorded on the day of repair. If the odometer is replaced, the mileage should be calculated with the mileage recorded by the previous odometer.
2. **Warranty period:** It refers to the time and mileage range of free maintenance under the conditions of in conformity with relevant policies and provisions of this Manual and relevant national laws and regulations.
3. **“Three guarantees” period:** It refers to the time and mileage range of maintenance, exchange and return under the conditions of in conformity with relevant policies and provisions of this Manual and relevant national laws and regulations. At present, there is no “three guarantees” period for the self-paying accessories.
4. **Self-paying accessories quality assurance period:** It is the period from the date of purchase (based on the purchase invoice) of the original parts of the Company by the Owner at the service center at his/her own expense and the mileage at that time. The date of purchase and the mileage at that time shall be noted by the service center on the purchase invoice, and the invoice shall be signed by the Owner.

The Owner shall present the Manual, the purchase invoice and settlement issued by the service center when requesting the service center for self-paying accessories quality assurance service. If the odometer fails or is damaged and has not been repaired in time, resulting in failure to confirm the mileage, the accumulated mileage will be calculated as 300 km/day from the date of purchase. If the odometer is replaced, the mileage should be calculated with the mileage recorded by the previous odometer. The self-paying accessories quality assurance period does not consist of the “three guarantees” period. Refer to the table below for details:



**Self-paying Accessories Quality Assurance Period**

S/N	Part	Warranty period	Three-guarantees validity
1	Fuse, relay, wiper blade, glass of whole vehicle, drive belt, oil filter, fuel filter, tire, air/ A/C filter element, brake lining, brake shoe, clutch friction plate, canister, spark plug, bulbs of whole vehicle, corrugated pipe and rubber parts	None	None
2	Battery, thermostat, exhaust pipe gasket, plastic parts, lamps, sunshade and digital clock	6 months or 10,000 km	None
3	All parts not listed in this table	12 months or 20,000 km	None

## **Maintenance**

### **Maintenance Purpose**

Proper vehicle maintenance will not only keep your vehicle in good working conditions but also be beneficial to environmental protection. To protect the environment and maintain a good condition, please carry out vehicle maintenance correctly.

### **Maintenance System**

All matters stipulated in this system apply to vehicles in the quality assurance period and are only for recommendation or reference for vehicles out of the quality assurance period.

1. The first maintenance of vehicles must be carried out within 3 months or 5,000 km of mileage (whichever comes first). You will have the right to be provided with the first free maintenance service within 3 months or 5,000 km of mileage (whichever comes first), and you will lose such right if any of the time and mileage exceeds the conditions. Free maintenance includes the man-hour fee and material fees for maintenance work. The cost of any maintenance other than the free service (including follow-up regular maintenance) shall be borne by the Owner.
2. The maintenance service provided to the Owner should be carried out in the service center. After the maintenance is completed, the service center shall fill in the "Maintenance Record Form", and the Owner shall sign it after confirmation.
3. The quality problems found during maintenance should be handled according to the provisions of the quality assurance service.
4. The Maintenance Specification Table stipulates the time and mileage for each maintenance. The maintenance must be maintained at the service center within the quality assurance period according to the time limit specified in the Maintenance Specification Table. After the maximum quality assurance period, e.g. after 5 years or 100,000 km of mileage, it is suggested to go to the service center for appropriate maintenance according to the time and mileage interval specified in the Maintenance Specification Schedule (or in advance as appropriate).

After 5 years or 100,000 km of mileage, it is suggested to go to the service center for appropriate maintenance according to the time and mileage interval specified in the Maintenance Specification Table (or in advance as appropriate).

**1. Routine Maintenance Specification Table:** When the vehicle is operated in a flat and less dusty environment, maintenance should be performed in accordance with the requirements of Routine Maintenance Specification Table or carried out in advance as appropriate:

Maintenance items	Maintenance time	(Time or mileage whichever comes shall prevail)											
	Time (months)	3	6	12	18	24	30	36	42	48	54	60	66
	Mileage (x1000 km)	5	10	15	20	25	30	35	40	45	50	55	60
<b>Engine</b>													
Engine oil and oil filter ①		R	R	R	R	R	R	R	R	R	R	R	R
Fuel filter			I	R	I	R	I	R	I	R	I	R	I
Air/ A/C filter element		I	I	R	I	R	I	R	I	R	I	R	I
Spark plug				I		R		I		R		I	
Engine coolant ①		I	I	I	I	R	I	I	I	R	I	I	I
State of intake and exhaust manifolds		I		I		I		I		I		I	
Drive belt and tensioning pulley		I	I		I		I		I		I		I
Cooling system pipeline and joint		I	I	I	I	I	I	I	I	I	I	I	I
Engine suspension fastening bolt and nut				I		I		I		I		I	
Engine harness and sensors		I		I			I		I		I		I



Maintenance time	(Time or mileage whichever comes shall prevail)												
	Time (months)	3	6	12	18	24	30	36	42	48	54	60	66
Maintenance items	Mileage (x1000 km)	5	10	15	20	25	30	35	40	45	50	55	60
Wheel nut													
Front/rear brake system related working components													
Steering wheel and steering linkage													
Door lock, hinge and stopper; lubricate if necessary													
Clutch and brake pedal free travel check													
Chassis and underbody fastening bolt and nut													
Tire rotation ②				R					R				
Tire condition and tire pressure (including spare tires) ②, ③													
Propeller shaft sheath and ball pin sheath													
Front/rear spring and shock absorber													
Cable/flexible shaft inspection (gear shift, accelerator pedal, clutch, hand brake etc.)													
<b>Air Conditioning and Electronics</b>													

## 190 Maintenance Procedures

Maintenance time	(Time or mileage whichever comes shall prevail)												
	Time (months)	3	6	12	18	24	30	36	42	48	54	60	66
Maintenance items	Mileage (x1000 km)	5	10	15	20	25	30	35	40	45	50	55	60
Air Conditioning System		I		I			I			I			I
Illumination and signal device		I	I	I	I	I	I	I	I	I	I	I	I
Windshield washing system		I	I	I	I	I	I	I	I	I	I	I	I
Battery connection and state		I	I	I	I	I	I	I	I	I	I	I	I

\* Description of symbols in the table

**I**- Inspect these items and associated parts; correct, tighten, clean, supplement, adjust or replace if necessary.

**R**- Replace or change.

① Refer to "Main Liquid Parameters" in Chapter "Technical Data" of this Manual.

② If necessary, perform four-wheel alignment or tire dynamic balancing.

③ Inspect the condition of tires before driving and check the tire pressure at least once a month with a tire pressure gauge.

**2. Non-routine Maintenance Specification Table:** When the vehicle is operated under the following severe conditions, maintenance should be performed in accordance with the requirements of Non-routine Maintenance Specification Table or carried out in advance as appropriate:

1. Most of the single travel distance is less than 10 km;
2. Always drive the vehicle at the outdoor temperatures of below 0°C or above 35°C;
3. In traffic jams, start and stop the vehicle repeatedly or drive the vehicle at idle or low speed for a long time;
4. Suddenly accelerate, decelerate or drive the vehicle at high speed driving frequently;
5. Frequently drive the vehicle on dusty roads, in hilly or mountainous areas;
6. Vehicles are used as police vehicle, taxis and other special vehicles for leasing or other operations.

**Non-routine Maintenance Specification Table**

Item	Maintenance interval
Engine oil and oil filter	Replace every 3 months or 5,000 km or in advance as appropriate
Transmission fluid	Replace every 18 months or 30,000 km or in advance as appropriate
Engine coolant	Replace every 12 months or 20,000 km or in advance as appropriate
Brake fluid	Replace every 12 months or 20,000 km or in advance as appropriate
Air/ A/C filter element	Replace every 3 months or 5,000 km or in advance as appropriate
Non-R items in Routine Maintenance Table	The maintenance interval specified in Routine Maintenance Table should be halved or carry out maintenance in advance on such basis as appropriate

### **Owner Support**

Owner satisfaction program

Owner satisfaction is very important to SAIC GM Wuling Automobile Co., Ltd. Generally, anything related to vehicle maintenance, use and claims should be resolved by the service center. If your problem is not resolved satisfactorily, you can take the following steps:

#### **Step I - Communicate with Service Center Staff**

Usually, communicating with the service center staff may solve your problem quickly. If there is any doubt about the handling result, please contact the person in charge of the service center.

#### **Step II - Ask the Customer Support Center for Help**

If you are still not satisfied with the result after contacting the person in charge of the service center, please contact the Customer Support Center (service hotline: 400-86-12345, 400-889-5050). We will do our utmost to solve your problems satisfactorily. When calling the staff of the Customer Support Center, please provide the following information:

- Your name, address and contact information (mobile phone number, residence phone number or company's phone number);
- Vehicle identification number (VIN);
- Date of purchase and current mileage;
- Problem description;

- Other helpful information required by the Customer Support Center staff to solve the problem.

In order to protect the legitimate rights and interests of consumers of household vehicle products, the methods and channels for dispute resolution of the Three Guarantees responsibility provided by the Company are as follows:

If there is any dispute over the Three Guarantees responsibility of household vehicle products, consumers can contact the person in charge of the service center via the owner satisfaction program. If the service center fails to solve your problem, please call our customer service hotline, and we will do our utmost to solve your problems satisfactorily. If the above method still does not solve your problems satisfactorily, please follow the relevant provisions of the "Responsibility Regulations for Repair, Replacement and Return of Household Vehicle Products".





**Maintenance Record Form (First Maintenance)**

**Record Form S/N** \_\_\_\_\_  
**Owner's Name** \_\_\_\_\_  
**Tel.** \_\_\_\_\_  
**Purchased on** \_\_\_\_\_  
**Maintenance Date** \_\_\_\_\_  
**Mileage (Km)** \_\_\_\_\_  
**VIN LZW** \_\_\_\_\_  
**Service Center Code** \_\_\_\_\_  
**Service Center Name (Official Seal)** \_\_\_\_\_  
**Working Personnel** \_\_\_\_\_

Duration of the first maintenance:  
3 months or 5,000 km (whichever comes first)

Free replacement

- **Engine oil**
- **Oil filter**
- **Manual transmission fluid (1.5 L engine)**

The 2nd maintenance reminder: (at an interval of 3 months or 5,000 km)

**Time:** \_\_\_\_\_

**Mileage:** \_\_\_\_\_

**Signature of Owner** \_\_\_\_\_

The first copy kept by the Owner



**Maintenance Record Form (First Maintenance)**

**Record Form S/N** \_\_\_\_\_  
**Owner's Name** \_\_\_\_\_  
**Tel.** \_\_\_\_\_  
**Purchased on** \_\_\_\_\_  
**Maintenance Date** \_\_\_\_\_  
**Mileage (Km)** \_\_\_\_\_  
**VIN LZW** \_\_\_\_\_  
**Service Center Code** \_\_\_\_\_  
**Service Center Name (Official Seal)** \_\_\_\_\_  
**Working Personnel** \_\_\_\_\_

Duration of the first maintenance:  
3 months or 5,000 km (whichever comes first)

Free replacement

- **Engine oil**
- **Oil filter**
- **Manual transmission fluid (1.5 L engine)**

The 2nd maintenance reminder: (at an interval of 3 months or 5,000 km)

**Time:** \_\_\_\_\_

**Mileage:** \_\_\_\_\_

**Signature of Owner** \_\_\_\_\_

The second copy kept by the service center



**Maintenance Record Form**

The 2nd maintenance record:

**Maintenance Date** \_\_\_\_\_

**Mileage** \_\_\_\_\_

The 3rd maintenance reminder: (at an interval of 6 months or **5,000** km)

**Time:** \_\_\_\_\_

**Mileage:** \_\_\_\_\_

**Service Center Code** \_\_\_\_\_

**Service Center Name (Official Seal)** \_\_\_\_\_

**Working Personnel** \_\_\_\_\_

**Signature of Owner** \_\_\_\_\_

The 3rd maintenance record:

**Maintenance Date** \_\_\_\_\_

**Mileage** \_\_\_\_\_

The 4th maintenance reminder: (at an interval of 6 months or **5,000** km)

**Time:** \_\_\_\_\_

**Mileage:** \_\_\_\_\_

**Service Center Code** \_\_\_\_\_

**Service Center Name (Official Seal)** \_\_\_\_\_

**Working Personnel** \_\_\_\_\_

**Signature of Owner** \_\_\_\_\_

**Maintenance Record Form**

The 4th maintenance record:

**Maintenance Date** \_\_\_\_\_

**Mileage** \_\_\_\_\_

The 5th maintenance reminder: (at an interval of 6 months or **5,000** km)

**Time:** \_\_\_\_\_

**Mileage:** \_\_\_\_\_

**Service Center Code** \_\_\_\_\_

**Service Center Name (Official Seal)** \_\_\_\_\_

**Working Personnel** \_\_\_\_\_

**Signature of Owner** \_\_\_\_\_

The 5th maintenance record:

**Maintenance Date** \_\_\_\_\_

**Mileage** \_\_\_\_\_

The 6th maintenance reminder: (at an interval of 6 months or **5,000** km)

**Time:** \_\_\_\_\_

**Mileage:** \_\_\_\_\_

**Service Center Code** \_\_\_\_\_

**Service Center Name (Official Seal)** \_\_\_\_\_

**Working Personnel** \_\_\_\_\_

**Signature of Owner** \_\_\_\_\_

**Maintenance Record Form**

The 6th maintenance record:

**Maintenance Date** \_\_\_\_\_

**Mileage** \_\_\_\_\_

The 7th maintenance reminder: (at an interval of 6 months or **5,000** km)

**Time:** \_\_\_\_\_

**Mileage:** \_\_\_\_\_

**Service Center Code** \_\_\_\_\_

**Service Center Name (Official Seal)** \_\_\_\_\_

**Working Personnel** \_\_\_\_\_

**Signature of Owner** \_\_\_\_\_

The 7th maintenance record:

**Maintenance Date** \_\_\_\_\_

**Mileage** \_\_\_\_\_

The 8th maintenance reminder: (at an interval of 6 months or **5,000** km)

**Time:** \_\_\_\_\_

**Mileage:** \_\_\_\_\_

**Service Center Code** \_\_\_\_\_

**Service Center Name (Official Seal)** \_\_\_\_\_

**Working Personnel** \_\_\_\_\_

**Signature of Owner** \_\_\_\_\_



**Maintenance Record Form**

The 8th maintenance record:

**Maintenance Date** \_\_\_\_\_

**Mileage** \_\_\_\_\_

The 9th maintenance reminder: (at an interval of 6 months or **5,000** km)

**Time:** \_\_\_\_\_

**Mileage:** \_\_\_\_\_

**Service Center Code** \_\_\_\_\_

**Service Center Name (Official Seal)** \_\_\_\_\_

**Working Personnel** \_\_\_\_\_

**Signature of Owner** \_\_\_\_\_

The 9th maintenance record:

**Maintenance Date** \_\_\_\_\_

**Mileage** \_\_\_\_\_

The 10th maintenance reminder: (at an interval of 6 months or **5,000** km)

**Time:** \_\_\_\_\_

**Mileage:** \_\_\_\_\_

**Service Center Code** \_\_\_\_\_

**Service Center Name (Official Seal)** \_\_\_\_\_

**Working Personnel** \_\_\_\_\_

**Signature of Owner** \_\_\_\_\_

**Maintenance Record Form**

The 10th maintenance record:

**Maintenance Date** \_\_\_\_\_

**Mileage** \_\_\_\_\_

The 11th maintenance reminder: (at an interval of 6 months or **5,000** km)

**Time:** \_\_\_\_\_

**Mileage:** \_\_\_\_\_

**Service Center Code** \_\_\_\_\_

**Service Center Name (Official Seal)** \_\_\_\_\_

**Working Personnel** \_\_\_\_\_

**Signature of Owner** \_\_\_\_\_

The 11th maintenance record:

**Maintenance Date** \_\_\_\_\_

**Mileage** \_\_\_\_\_

The 12th maintenance reminder: (at an interval of 6 months or **5,000** km)

**Time:** \_\_\_\_\_

**Mileage:** \_\_\_\_\_

**Service Center Code** \_\_\_\_\_

**Service Center Name (Official Seal)** \_\_\_\_\_

**Working Personnel** \_\_\_\_\_

**Signature of Owner** \_\_\_\_\_

**Maintenance Record Form**

The 12th maintenance record:

**Maintenance Date** \_\_\_\_\_

**Mileage** \_\_\_\_\_

The 13th maintenance reminder: (at an interval of 6 months or **5,000** km)

**Time:** \_\_\_\_\_

**Mileage:** \_\_\_\_\_

**Service Center Code** \_\_\_\_\_

**Service Center Name (Official Seal)** \_\_\_\_\_

**Working Personnel** \_\_\_\_\_

**Signature of Owner** \_\_\_\_\_







**Product Defect Report**

The information provided by the Owner is an important clue for the Defective Product Administrative Center and the Company to judge whether there are defects. Therefore, please contact the Company and the ACSIQ Defective Product Administrative Center if the vehicle may be defective.